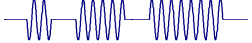
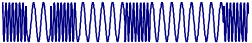
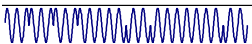

## Communication methods

- Communication methods
  - Media and signalling conventions used to transmit data between digital devices
  - Different physical layers methods including:
    - wires, radio frequency (RF), optical (IR)
  - Different encoding schemes including:
    - amplitude, frequency, and pulse-width modulation

Modulation Technique	Waveform
No encoding (Baseband)	
On-Off Keying (OOK)	
Frequency Shift Keying (FSK)	
Binary Phase Shift Keying (BPSK)	

## Communication methods

- Dimensions to consider
  - bandwidth – number of wires – serial/parallel
  - speed – bits/bytes/words per second
  - timing methodology – synchronous or asynchronous
  - number of destinations/sources
  - arbitration scheme – daisy-chain, centralized, distributed
  - protocols – provide some guarantees as to correct communication

# Bandwidth

- **Serial**
  - Single wire or channel to transmit information one bit at a time
  - Requires synchronization between sender and receiver
  - Sometimes includes extra wires for clock and/or handshaking
  - Good for inexpensive connections (e.g., terminals)
  - Good for long-distance connections (e.g., LANs)
  - Examples: RS-232, Ethernet, I2C, IrDA, USB, Firewire, Bluetooth
- **Parallel**
  - Multiple wires to transmit information one byte or word at a time
  - Good for high-bandwidth requirements (CPU to disk)
  - More expensive wiring/connectors/current requirements
  - Examples: SCSI-2, PCI bus (PC), PCMCIA (Compact Flash)
- **Issues**
  - Encoding, data transfer rates, cost of connectors and wires, modularity, error detection and/or correction

# Speed

- **Serial**
  - low-speed, cheap connections
    - RS-232 1K-20K bits/sec, copper wire
  - medium-speed efficient connections
    - I2C 10K-400K bits/sec, board traces
    - IrDA 9.6K-4M bits/sec, line-of-sight, 0.5-6.0m
  - high-speed, expensive connections
    - USB 1.5M bytes/sec, USB2 60M bytes/sec
    - Ethernet 1.5M-1G bits/sec, twisted-pair or co-axial
    - Firewire 12.5-50M bytes/sec
- **Parallel**
  - low-speed, not too wide
    - SCSI-2 10M bytes/sec, 8 bits wide
    - PCI bus, 250M bytes/sec, 32 bits wide
    - PCMCIA (CF+), 9-10M bytes/sec, 16 bits wide
  - high-speed, very wide – memory systems in large multi-processors
    - 200M-2G bytes/sec, 128-256 bits wide

# Speed

- Issues
  - length of the wires (attenuation, noise, capacitance)
  - connectors (conductors and/or transducers)
  - environment (RF/IR interference, noise)
  - current switching (spikes on supply voltages)
  - number and types of wires (cost of connectors, cross-talk)
  - flow-control (if communicating device can't keep up)

# Timing methodology

- Asynchronous
  - less wires (no clock)
  - no skew concerns
  - synchronization overhead
  - appropriate for loosely-coupled systems (CPU and peripherals)
  - common in serial schemes
- Synchronous
  - clock wires and skew concerns
  - no synchronization overhead
  - can be high-speed if delays are small and can be controlled
  - appropriate for tightly-couple systems (CPU and memory/disk)
  - common in parallel schemes

## Timing methodology

- Issues
  - clock period and wire delay
  - synchronization and skew
  - encoding of timing and data information
  - handshaking
  - flow-control
  - power consumption

## Number of devices communicating

- Single source – single destination
  - point-to-point
  - cheap connections, no tri-stating necessary
- Single source – multiple destination
  - fanout limitations
  - addressing scheme to direct data to one destination
- Multiple source – multiple destination
  - arbitration between senders
  - tri-stating capability is necessary
  - collision detection
  - addressing scheme
  - priority scheme
  - fairness considerations

## Arbitration schemes

- Daisy-chain or token passing
  - devices either act or pass to next
  - fixed priority order
  - as many wires as devices
  - fairness issues
- Centralized
  - request to central arbiter
  - central arbiter implements priority scheme
  - wires from/to each device can be costly
  - can be dynamically changing priority/fairness
- Distributed
  - no central arbiter
  - common set of wires (or ether) observed by all devices
  - fixed priority/fairness scheme

## Serial case studies

- RS-232 (IEEE standard)
  - serial protocol for point-to-point, low-cost, low-speed applications for PCs
- I2C (Philips)
  - up to 400Kbits/sec, serial bus for connecting multiple components
- Ethernet (popularized by Xerox)
  - most popular local area network protocol with distributed arbitration
- IrDA (Infrared Data Association)
  - up to 115kbps wireless serial (Fast IrDA up to 4Mbs)
- Firewire (Apple – now IEEE1394)
  - 12.5-50Mbytes/sec, consumer electronics (video cameras, TVs, audio, etc.)
- SPI (Motorola)
  - 10Mbits/sec, commonly used for microcontroller to peripheral connections
- USB (Intel – followed by USB-2)
  - 12-480Mbits/sec, isochronous transfer, desktop devices
- Bluetooth (Ericsson – cable replacement)
  - 700Kbits/sec, multiple portable devices, special support for audio

## RS-232 (standard serial line)

- Point-to-point, full-duplex
- Synchronous or asynchronous
- Flow control
- Variable baud (bit) rates
- Cheap connections (low-quality and few wires)
- Variations: parity bit; 1, 1.5, or 2 stop bits

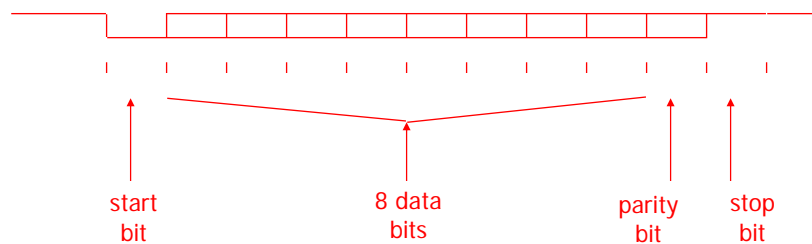

## RS-232 wires

- TxD – transmit data
  - TxC – transmit clock
  - RTS – request to send
  - CTS – clear to send
  - RxD – receive data
  - RxC – receive clock
  - DSR – data set ready
  - DTR – data terminal ready
  - Ground
- all wires active low  
"0" = -12v, "1" = 12v
- special driver chips that generate  $\pm 12v$  from 5v

## Transfer modes

- Synchronous
  - clock signal wire is used by both receiver and sender to sample data
- Asynchronous
  - no clock signal in common
  - data must be oversampled (16x is typical) to find bit boundaries
- Flow control
  - handshaking signals to control rate of transfer

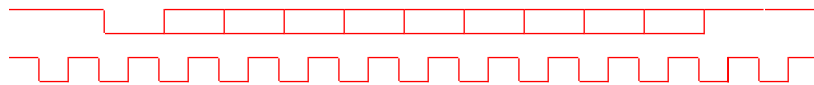

## Inter-Integrated Circuit Bus (I2C)

- Modular connections on a printed circuit board
- Multi-point connections (needs addressing)
- Synchronous transfer (but adapts to slowest device)
- Similar to Controller Area Network (CAN) protocol used in automotive applications
- Similar to TWI (Two-Wire Interface) on ATmegs

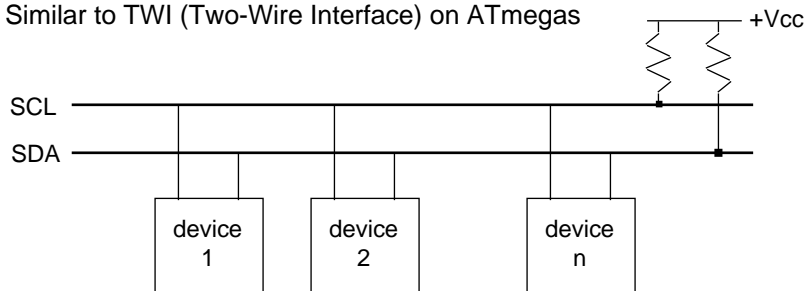

## Serial data format

- SDA going low while SCL high signals start of data
- SDA going high while SCL high signals end of data
- SDA can change when SCL low
- SCL high (after start and before end) signals that a data bit can be read

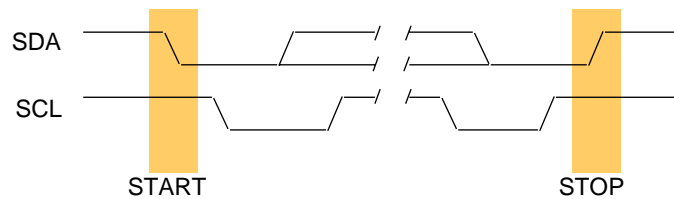

## Byte transfer

- Byte followed by a 1 bit acknowledge from receiver
- Open-collector wires
  - sender allows SDA to rise
  - receiver pulls low to acknowledge after 8 bits

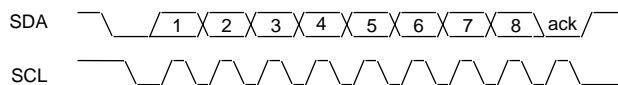

- Multi-byte transfers
  - first byte contains address of receiver
  - all devices check address to determine if following data is for them
  - second byte usually contains address of sender



## Clock synchronization

- Synchronous data transfer with variable speed devices
  - go as fast as the slowest device involved in transfer
- Each device looks at the SCL line as an input as well as driving it
  - if clock stays low even when being driven high then another device needs more time, so wait for it to finish before continuing
  - rising clock edges are synchronized

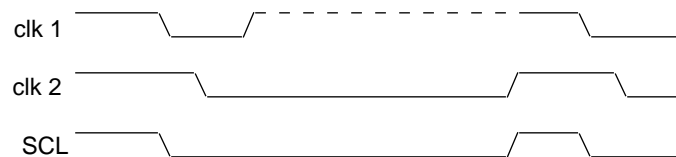

## Arbitration

- Devices can start transmitting at any time
  - wait until lines are both high for some minimum time
  - multiple devices may start together - clocks will be synchronized
- All senders will think they are sending data
  - possibly slowed down by receiver (or another sender)
  - each sender keeps watching SDA - if ever different (driving high, but its really low) then there is another driver
  - sender that detects difference gets off the bus and aborts message
- Device priority given to devices with early 0s in their address
  - 00...111 has higher priority than 01...111

## Inter-Integrated Circuit Bus (I2C)

- Supports data transfers from 0 to 400KHz
- Philips (and others) provide many devices
  - microcontrollers with built-in interface
  - A/D and D/A converters
  - parallel I/O ports
  - memory modules
  - LCD drivers
  - real-time clock/calendars
  - DTMF decoders
  - frequency synthesizers
  - video/audio processors

## Ethernet (Xerox local area network)

- Local area network
  - up to 1024 stations
  - up to 2.8 km distance
  - 10Mbits/sec serially on shielded co-axial cable
  - 1.5Mbits/sec on twisted pair of copper pair
- Developed by Xerox in late 70s
  - still most common LAN right now
  - being displaced by fiber-optics (can't handle video/audio rates or make required service guarantees)
- High-level protocols to ensure reliable data transmission
- CSMA-CD: carrier sense multiple access with collision detection

## Ethernet layered organization

- Physical and data-link layers are our focus

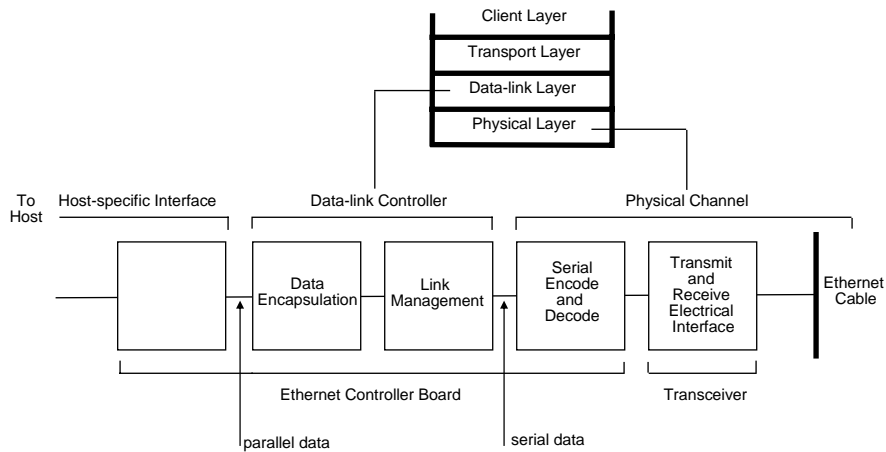

## Serial data format

- Manchester encoding
  - signal and clock on one wire (XORed together)
  - "0" = low-going transition
  - "1" = high-going transition

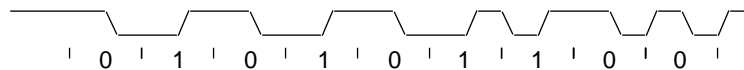

- Extra transitions between 00 and 11 need to be filtered
  - preamble at beginning of data packet contains alternating 1s and 0s
  - allows receivers to get used to where important transitions should be and ignore extra ones (this is how synchronization is achieved)
  - preamble is 48 bits long: 10101...01011

## Ethernet packet

- Packets size: 64 to 1518 bytes + 6 bytes of preamble

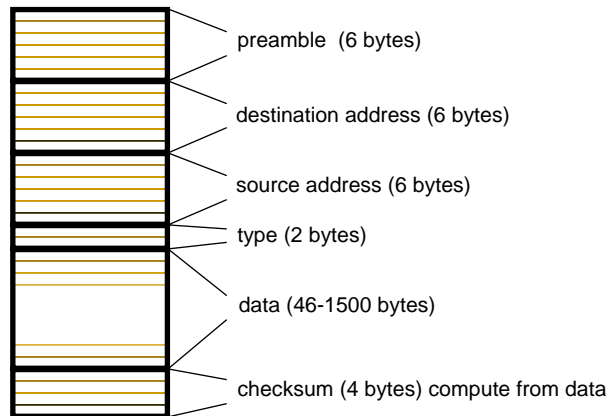

## Arbitration

- Wait for line to be quiet for a while then transmit
  - detect collision
  - average value on wire should be exactly between 1 and 0
  - if not, then two transmitters are trying to transmit data
- If collision, stop transmitting
  - wait a random amount of time and try again
  - if collide again, pick a random number from a larger range (2x) and try again
- Exponential backoff on collision detection
- Try up to 16 times before reporting failure

## Extending Ethernet

- Segments, repeaters, and gateways
  - segment: a single cable
  - repeater: transfers all messages on one segment to another and vice-versa
  - gateway: selectively forwards messages to other segments and helps isolate traffic

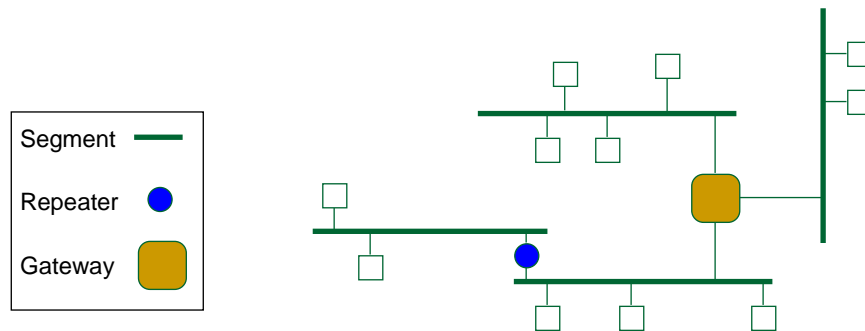

## Infrared Data Association

- Consortium of over 160 companies
- Meet needs of the “mobile professional”
  - Short interactions with other devices (file transfer, printing)
  - Possibly using others' peripherals (visiting a customer's office)
- Goals:
  - Suitable replacement for cables
  - Interoperability
  - Minimal cost
  - “Point-and-shoot” model (intended use and to reduce interference)
- History:
  - First standard developed in 1994
  - Revisions as recently as late 1998 (i.e., still active)

# IrDA: Infrared Data Association

- Characteristics of IR:
  - Implementation costs rise significantly around 1-10 GHz
    - one important exception is IR at around 500 THz – very inexpensive
  - Signals above 100 GHz cannot penetrate walls
  - Most signals below 300 GHz are regulated by the FCC

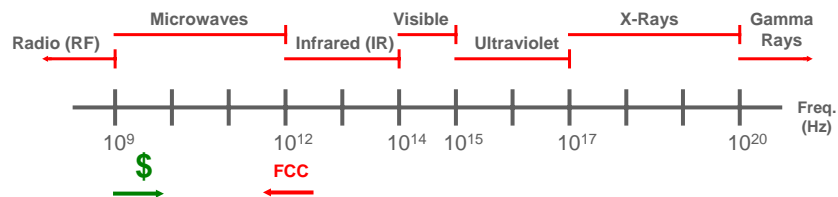

# Speed

- Components include:
  - Transmitter (LED) and paired receiver (photodiode)
- IrDA supports wide range of speeds
  - 2400 bps to 4 Mbps
  - Exact physical-layer protocol used depends on speed of IrDA connection
  - Uses highest speed available on both devices
    - determined when connection is established
- Future promises even higher speeds:
  - 16-50 Mbps is not too far off
- Comparison to other wireless technologies:
  - Low-power RF (e.g., Bluetooth) slightly slower (.5 - 2 Mbps max)
  - Bound by walls, easy to control, intentional aspect
  - Much lower-power than high-speed RF (e.g., 802.11a at 50Mbps)

# Low-speed Modulation

- Speed: 2400 bps - 115 kbps ("Serial Infrared", or SIR)
  - Only 0's require pulse (and thus power) ; pulse < full bit time
  - Standard UART byte framing
  - Pulse is constant 1.6  $\mu$ s long (so duty cycle varies with speed)
  - Average duty cycle:  $\leq 9\%$
  
- Speed: 576 kbps - 1 Mbps
  - similar to SIR (pulse only for 0's ; pulse < full bit time)
  - pulse lasts 1/4 of bit time (so pulse varies with speed)
  - Average duty cycle: 12.5%
  
- Speed: 4 Mbps ("Fast Infrared", or FIR)
  - uses four-pulse-position-modulation scheme (4PPM)
  - pulse during exactly 1/4 of each symbol boundary
  - 4PPM makes synchronization easier to maintain
  - Duty cycle: 25% (independent of data)
  - Lowest power/bit

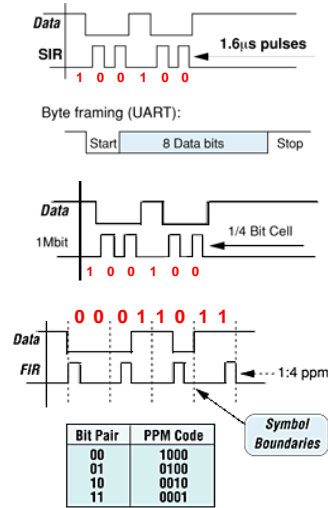

# Range

- Linear:
  - IrDA standard requires 0-1 m
  - Realistically, some transceivers work at up to 10 m
- Angular:
  - Limited to a narrow cone (15° half-angle)
  - Helps reduce interference between devices

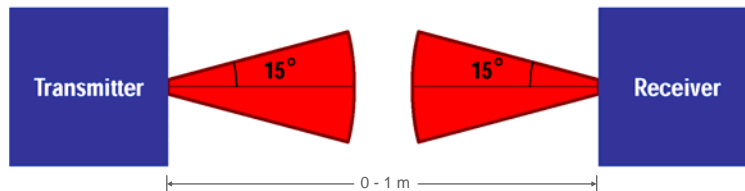

## IrDA Protocol Stack

- Analogous to the standard layered network model
- Consists of both required and optional components

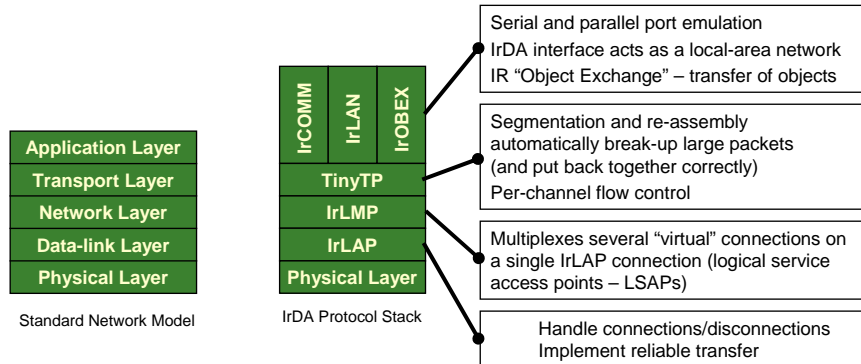

## Protocol Overhead

- Very simple model (point-to-point), so can expect reduced protocol overhead
- For layers in IrDA protocol stack, overhead per packet/frame is:
  - IrLAP = 2 bytes
  - IrLMP = 2 bytes
  - TinyTP = 1 byte

} **Total: 5 bytes**
- For perspective, compare to TCP/IP over Ethernet:
  - Ethernet = 18 bytes minimum
  - IP = 20 bytes
  - TCP = 20 bytes

} **Total: 58 bytes (minimum)**
- IrDA takes advantage of its simpler model, and keeps protocol overhead very low.



# Firewire

- Interconnection for high-bandwidth consumer electronic devices
  - e.g., still and video cameras, MP3 players, digital video recorders
  - IEEE 1394a standard
  - 12.5-400 Mb/s (soon to be 800 Mb/s with 1394b)
    - Most consumer devices use 100 Mb/s
  - Up to 63 devices connected at once on 4.5m cables
    - Up to 16 cables can be daisy-chained to 72m
  - Devices connect for power as well as communication
  - Hot-swappable devices
  - Asynchronous and isochronous data transfers

# Firewire Electrical/Mechanical Spec

- 4-6 wires depending on whether device needs power
- Tree arrangement
  - each branch is bandwidth limited

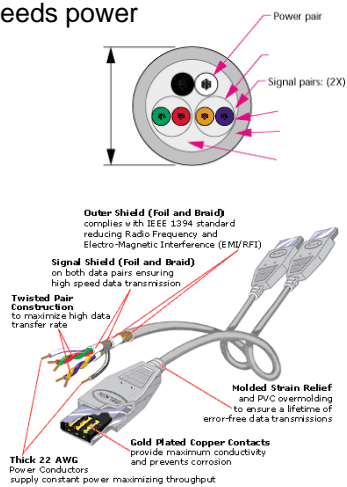
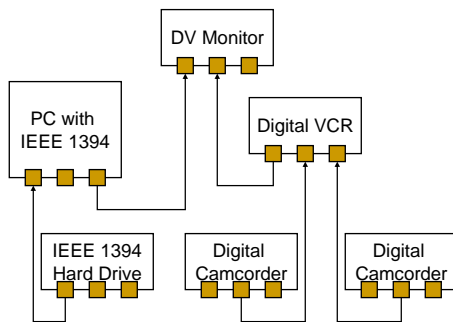

## Firewire data format

- Data is transferred in addressed packets, and is transaction-based
- Transfers can be asynchronous or isochronous
  - Asynchronous transfers are used mainly for bus configuration, setting up transfers and handshaking, but are also used for bulk data transfer to and from hard disk drives, etc.
  - Isochronous transfers are used for transporting timesensitive data like digital video and audio
- Data packets have a 64-bit address header
  - 10-bit network address
  - 6-bit node address
  - 48-bits for data memory addresses at the receiving node
- Ability to address 1023 networks of 63 nodes, each with up to 281TB (terabytes) of data addresses

## Firewire data format (cont'd)

- Bus manager
  - One device on the bus (usually a PC)
- Isochronous resource manager
  - Allocates bus bandwidth for isochronous data transfers based on time-domain multiplexing (TDM) that guarantees a proportion of the total time slots to each device
    - Bandwidth allocation unit is 20.3ns, 6144 of them in a basic cycle of 125us
    - 25us of every cycle is always reserved for asynchronous control data transfers, so a maximum of 4195 units are available for isochronous transfers
    - Typically a stream from a DV camcorder to a PC or DVR might need to be allocated a channel of ~1800 bandwidth units, for about 30Mb/s
  - Asynchronous transfers can have multiple data packets per basic cycle, within the 25us reserved for this type of signalling

## Firewire signalling

- Data-strobe signalling
  - Avoids two signals where both change at the same time
  - Keeps noise levels low
- Strobe easily derived at transmitter
  - $\text{Strobe} = \text{Clock} \underline{\text{xor}} \text{Data}$
- Clock is easily recovered at receiver
  - $\text{Clock} = \text{Data} \underline{\text{xor}} \text{Strobe}$

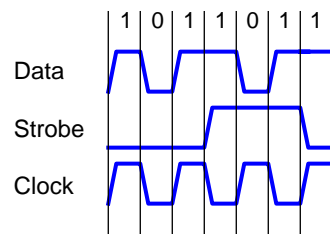

## Serial Peripheral Interface

- Common serial interface on many microcontrollers
- Simple 8-bit exchange between two devices
  - Master initiates transfer and generates clock signal
  - Slave device selected by master
- One-byte at a time transfer
  - Data protocols are defined by application
  - Must be in agreement across devices

## SPI Block Diagram

- 8-bits transferred in each direction every time
- Master generates clock
- Shift enable used to select one of many slaves

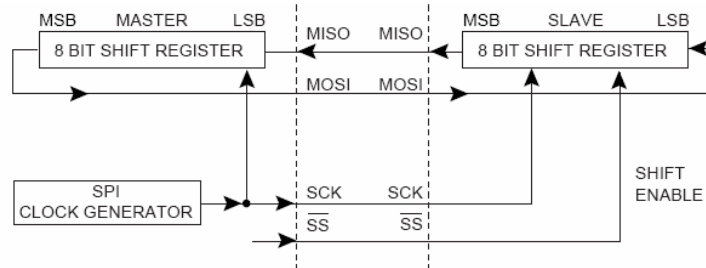

## SPI on the ATmega16

- Prescaler for clock rate
- Interrupt on receive and on send complete
- Automatically generates SS

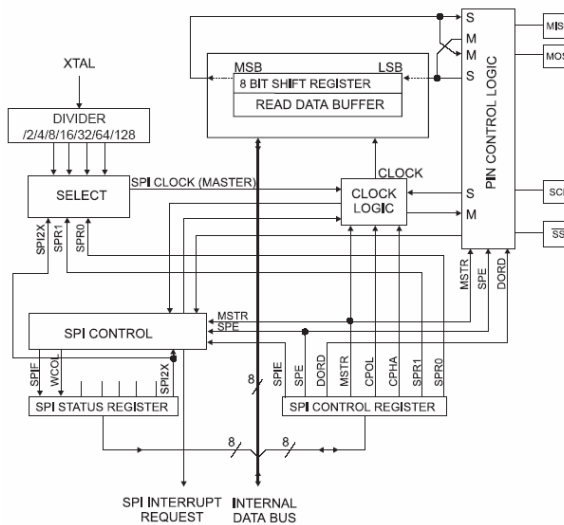

## SPI Registers

### SPI Control Register – SPCR

Bit	7	6	5	4	3	2	1	0	
	<b>SPIE</b>	<b>SPE</b>	<b>DORD</b>	<b>MSTR</b>	<b>CPOL</b>	<b>CPHA</b>	<b>SPR1</b>	<b>SPR0</b>	SPCR
Read/Write	R/W	R/W	R/W	R/W	R/W	R/W	R/W	R/W	
Initial Value	0	0	0	0	0	0	0	0	

### SPI Status Register – SPSR

Bit	7	6	5	4	3	2	1	0	
	<b>SPIF</b>	<b>WCOL</b>	–	–	–	–	–	<b>SPI2X</b>	SPSR
Read/Write	R	R	R	R	R	R	R	R/W	
Initial Value	0	0	0	0	0	0	0	0	

## Using SPI as a Master

```
void SPI_MasterInit(void)
{
    /* Set MOSI and SCK output, all others input */
    DDRB = _BV(DD_MOSI) | _BV(DD_SCK);
    /* Enable SPI, Master, set clock rate fclk/16 */
    SPCR = _BV(SPE) | _BV(MSTR) | _BV(SPR0);
}

void SPI_MasterTransmit(char cData)
{
    /* Start transmission */
    SPDR = cData;
    /* Wait for transmission complete */
    while(!(SPSR & _BV(SPIF)))
    ;
}
```

## Using SPI as a Slave

```
void SPI_SlaveInit(void)
{
    /* Set MISO output, all others input */
    DDRB = _BV(DD_MISO);
    /* Enable SPI */
    SPCR = _BV(SPE);
}

char SPI_SlaveReceive(void)
{
    /* Wait for reception complete */
    while(!(SPSR & _BV(SPIF)))
    ;
    /* Return data register */
    return SPDR;
}
```

## Data Payload on SPI

- Data is exchanged between master and slave
  - Master always initiates
  - May need to poll slave (or interrupt-driven)
- Decide on how many bytes of data have to move in each direction
  - Transfer the maximum for both directions
  - One side may get more than it needs
  - May disable one side or the other
- Decide on format of bytes in packet
  - Starting byte and/or ending byte?
  - Can they be distinguished from data in payload?
  - Length information or fixed size?
- SPI buffer
  - Write into buffer, specify length, master sends it out, gets data
  - New data arrives at slave, slave interrupted, provides data to go to master, reads data from master in buffer

## Sample code for FTDI SPI

```
int main(void)
{
    FTDI466API usbDevice;
    char buffer[256];
    unsigned char rxBuffer[256];
    unsigned char txBuffer[256];
    DWORD numBytesToSend;
    DWORD bytesSent;
    DWORD numBytesToRead;
    DWORD bytesReceived;
    // setup USB device for MPSSE mode
    bool setup = usbDevice.open();
    if(!setup)
        return 0;
    cout << "INITIALIZING SPI" << endl;
    // setup for SPI communication
    txBuffer[0] = 0x80; // setup PORT
    txBuffer[1] = 0x08; // make CS high
    txBuffer[2] = 0x0B; // outputs: SK, DO, CS, inputs: DI, GPIOL1-L4
    txBuffer[3] = 0x86; // set clk divisor to Tx at 200kHz
    txBuffer[4] = 0x1D; // speed low byte
    txBuffer[5] = 0x00; // speed high byte
    txBuffer[6] = 0x85; // disconnect TDI/DO output from TDO/DI input for loopback testing
    numBytesToSend = 7;
```

## Sample code for FTDI SPI (cont'd)

```
// send the instructions to the USB device
bytesSent = usbDevice.write(txBuffer, numBytesToSend);

if(bytesSent != numBytesToSend)
    cerr << "Not all the bytes were sent when initializing MPSSE" << endl;

// see if there were any error codes when setting up SPI
numBytesToRead = usbDevice.getReceiveQueueSize();

if(numBytesToRead > 0)
{
    bytesReceived = usbDevice.read(rxBuffer, numBytesToRead);

    if(bytesReceived != numBytesToRead)
        cerr << "Problem when trying to retrieve the error bytes" << endl;

    for(unsigned int i = 0; i < bytesReceived; i++)
        cout << "Error Byte: " << rxBuffer[i] << endl;
}
```

## Sample code for FTDI SPI (cont'd)

```
// loop to demonstrate the SPI protocol
for(int loop = 0; loop < 10; loop++)
{
    Sleep(1000);

    txBuffer[0] = 0x80; // setup PORT
    txBuffer[1] = 0x00; // make CS low
    txBuffer[2] = 0x0B; // outputs: SK, DO, CS, inputs: DI, GPIOL1-L4
    txBuffer[3] = 0x35; // clock out on negative edge, in on negative edge, MSB
    txBuffer[4] = 0x04; // low byte of length : note a length of zero is 1 byte, 1 is 2 bytes
    txBuffer[5] = 0x00; // high byte of length
    txBuffer[6] = 0x71; // payload
    txBuffer[7] = 0x72;
    txBuffer[8] = 0x73;
    txBuffer[9] = 0x74;
    txBuffer[10] = 0x75;
    txBuffer[11] = 0x80; // setup PORT
    txBuffer[12] = 0x08; // make CS high
    txBuffer[13] = 0x0B; // outputs: SK, DO, CS, inputs: DI, GPIOL1-L4

    numBytesToSend = 14;

    // send bytes
    bytesSent = usbDevice.write(txBuffer, numBytesToSend);
    if(bytesSent != numBytesToSend)
        cerr << "Not all the bytes were sent when initializing MPSSE" << endl;
}
```

## Sample code for FTDI SPI (cont'd)

```
Sleep(5); // make sure the usb device has enough time to execute command - 5 ms latency timeout is set

// get number of bytes in the received queue
numBytesToRead = usbDevice.getReceiveQueueSize();
cout << "Received " << numBytesToRead << " Bytes" << endl;
if(numBytesToRead > 0)
{
    // get the received bytes
    bytesReceived = usbDevice.read(rxBuffer, numBytesToRead);

    if(bytesReceived != numBytesToRead)
        cerr << "Problem when trying to retrieve the bytes from the receive queue" << endl;
    else
    {
        // print out the bytes received over SPI in hex
        for(unsigned int i=0; i < bytesReceived; i++)
            cout << itoa(rxBuffer[i],buffer,16) << " ";
        cout << endl;
    }
}
}
```



## Universal Serial Bus

- Connecting peripherals to PCs
  - Ease-of-use
  - Low-cost
  - Up to 127 devices (optionally powered through bus)
  - Transfer rates up to 480 Mb/s
    - Variable speeds and packet sizes
    - Full support for real-time data for voice, audio, and video
    - Protocol flexibility for mixed-mode isochronous data transfers and asynchronous messaging
  - PC manages bus and allocates slots (host controller)
    - Can have multiple host controllers on one PC
    - Support more devices than 127

## USB Peripherals

<u>PERFORMANCE</u>	<u>APPLICATIONS</u>	<u>ATTRIBUTES</u>
<b>LOW-SPEED</b> <ul style="list-style-type: none"> <li>• Interactive Devices</li> <li>• 10 – 100 kb/s</li> </ul>	Keyboard, Mouse Stylus Game Peripherals Virtual Reality Peripherals	Lowest Cost Ease-of-Use Dynamic Attach-Detach Multiple Peripherals
<b>FULL-SPEED</b> <ul style="list-style-type: none"> <li>• Phone, Audio, Compressed Video</li> <li>• 500 kb/s – 10 Mb/s</li> </ul>	POTS Broadband Audio Microphone	Lower Cost Ease-of-Use Dynamic Attach-Detach Multiple Peripherals Guaranteed Bandwidth Guaranteed Latency
<b>HIGH-SPEED</b> <ul style="list-style-type: none"> <li>• Video, Storage</li> <li>• 25 – 400 Mb/s</li> </ul>	Video Storage Imaging Broadband	Low Cost Ease-of-Use Dynamic Attach-Detach Multiple Peripherals Guaranteed Bandwidth Guaranteed Latency High Bandwidth

# USB

- Tree of devices  
– one root controller

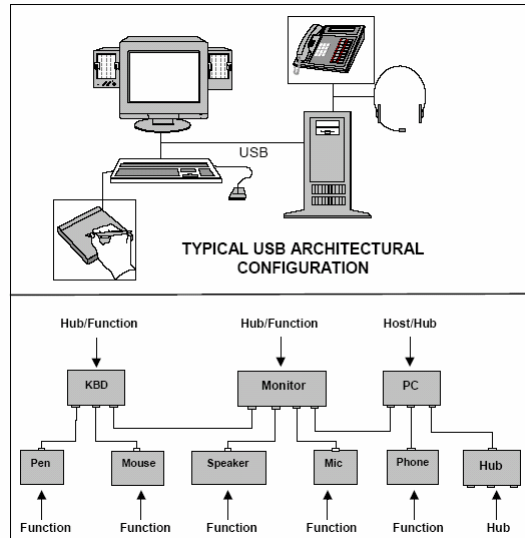

# USB Data Transfer

- Data transfer speeds
  - Low is  $<0.8v$ , high is  $>2.0v$  differential
  - 480Mb/sec, 12Mb/sec, 1.5Mb/sec
  - Data is NRZI encoded (data and clock on one wire)
  - SYNC at beginning of every packet

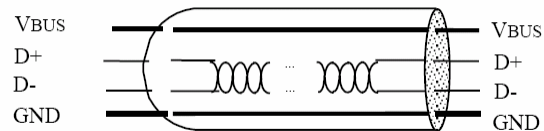

# NRZI Encoding

- NRZI – Non-return to zero inverted
  - Toggles a signal to transmit a “0” and leaves the signal unchanged for a “1”
  - Also called transition encoding
  - Long string of 0s generates a regular waveform with a frequency half the bit rate
  - Long string of 1s generates a flat waveform – bit stuff a 0 every 6 consecutive 1s to guarantee activity on waveform

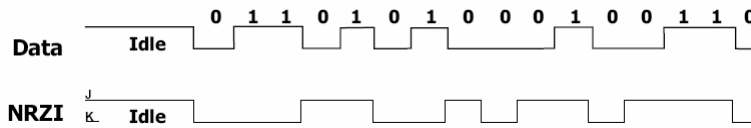

# NRZI Encoding (cont'd)

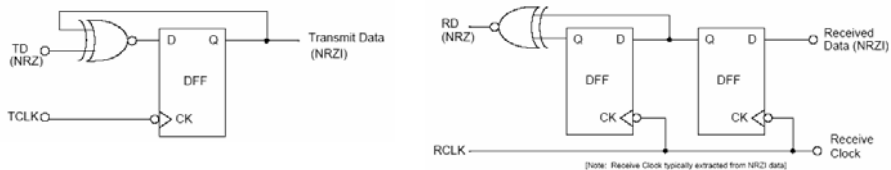
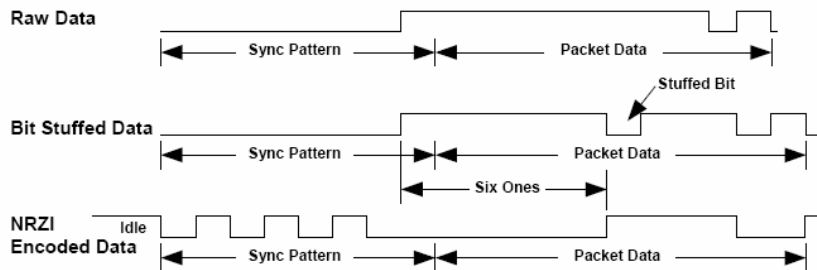

## USB Data Transfer Types

- Control Transfers:
  - Used to configure a device at attach time and can be used for other device-specific purposes, including control of other pipes on the device.
- Bulk Data Transfers:
  - Generated or consumed in relatively large and bursty quantities and have wide dynamic latitude in transmission constraints.
- Interrupt Data Transfers:
  - Used for timely but reliable delivery of data, for example, characters or coordinates with human-perceptible echo or feedback response characteristics.
- Isochronous Data Transfers:
  - Occupy a prenegotiated amount of USB bandwidth with a prenegotiated delivery latency. (Also called streaming real time transfers)

## USB Packet Format

- Sync + PID + data + CRC
- Basic data packet
  - Sync: 8 bits (00000001)
  - PID: 8 bits (packet id – type)
  - Data: 8-8192 bits (1K bytes)
  - CRC: 16 bits (cyclic redundancy check sum)
- Other data packets vary in size
  - May be as short as only 8 bits of PID

## USB Protocol Stack

- FTDI USB chip implements right side
- Communicates to physical device through SPI

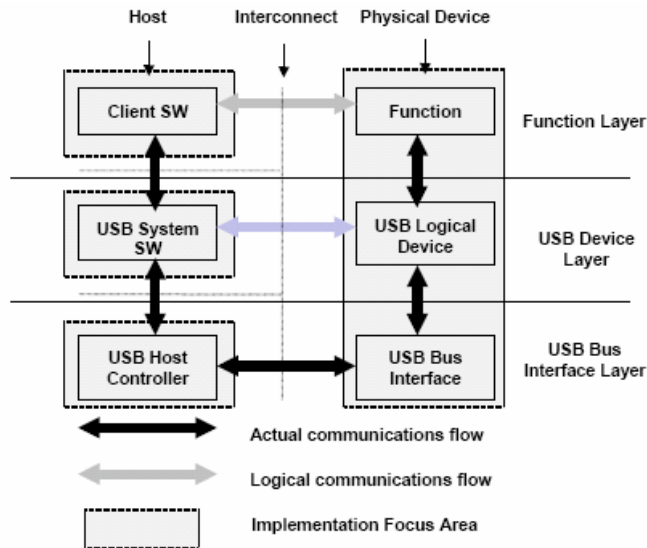

## More Communication Later

- Bluetooth
  - Popular radio frequency protocol
  - We'll discuss after looking at wireless sensors
- IEEE 802.15.4 (Zigbee) – we'll start using this in Lab 6
  - Up and coming sensor protocol
- Ultra-wide-band (UWB)
  - Ultra-low-power future home wireless
- CompactFlash/SD
  - Popular parallel bus protocol
  - We'll discuss (time permitting) at end of quarter