

Topic

- How routing protocols work with IP
 - The Host/Router distinction

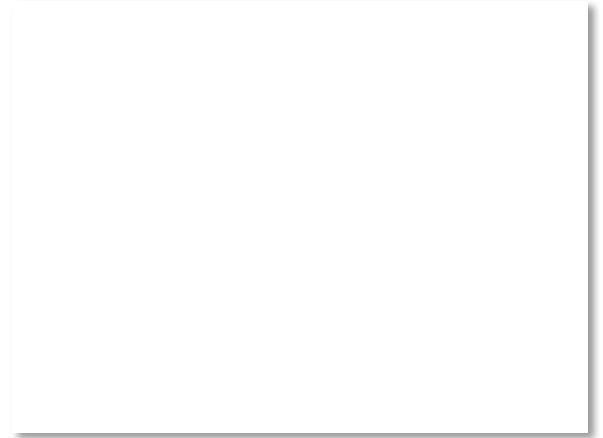
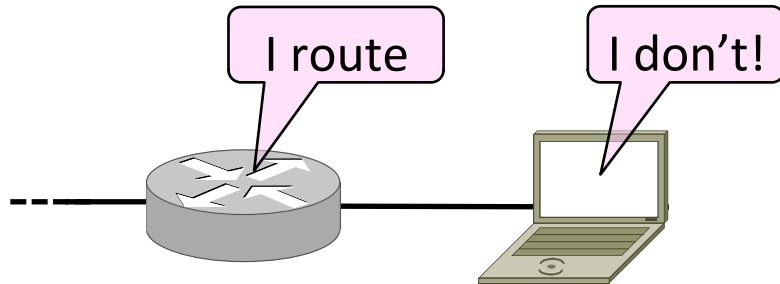

Recap

- In the Internet:
 - Hosts on same network have IP addresses in the same IP prefix
 - Hosts just send off-network traffic to the nearest router to handle
 - Routers discover the routes to use
 - Routers use longest prefix matching to send packets to the right next hop

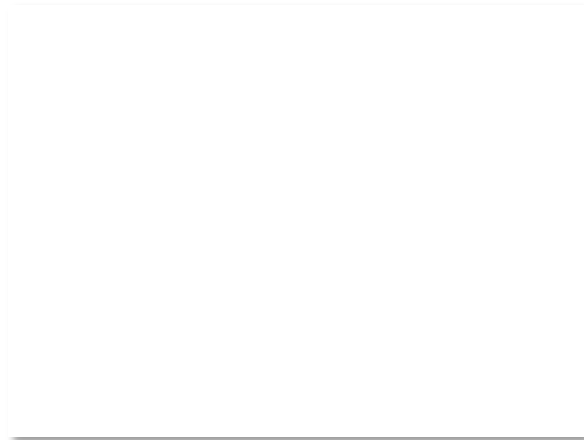

Host/Router Combination

- Hosts attach to routers as IP prefixes
 - Router needs table to reach all hosts

Single network
(One IP prefix "P")

IP router
"A"

Rest of
network

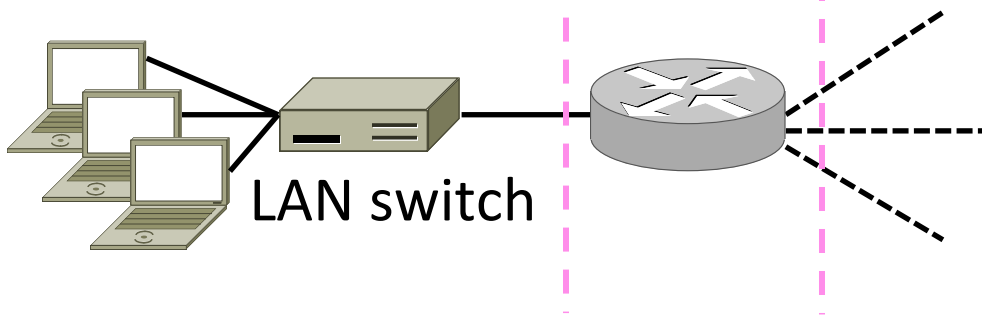

Network Topology for Routing

- Group hosts under IP prefix connected directly to router
 - One entry for all hosts

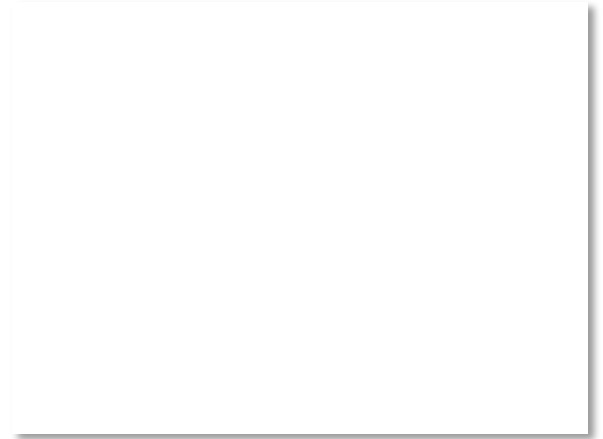
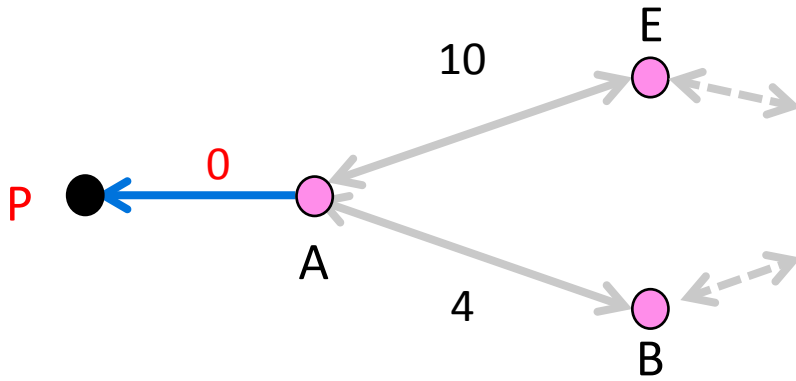

Network Topology for Routing (2)

- Routing now works as before!
 - Routers advertise IP prefixes for hosts
 - Router addresses are “/32” prefixes
 - Lets all routers find a path to hosts
 - Hosts find by sending to their router

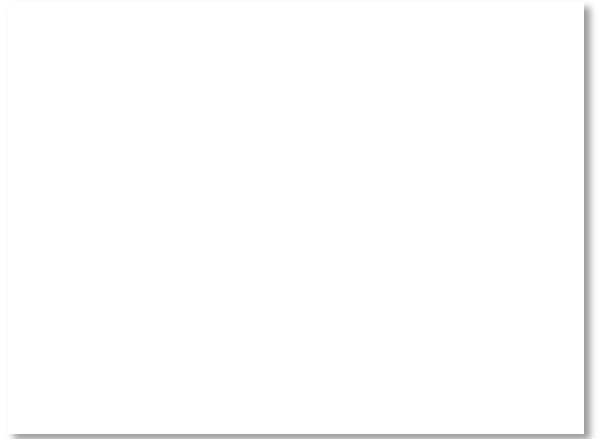

Topic

- How to scale routing with hierarchy in the form of regions
 - Route to regions, not individual nodes

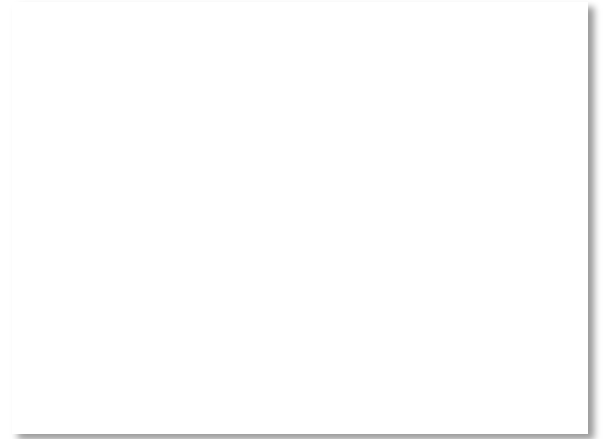
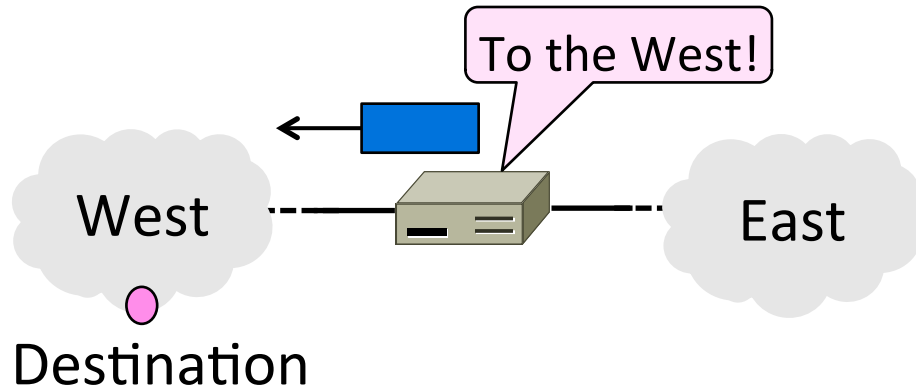

Internet Growth

- At least a billion Internet hosts and growing ...

Internet Domain Survey Host Count

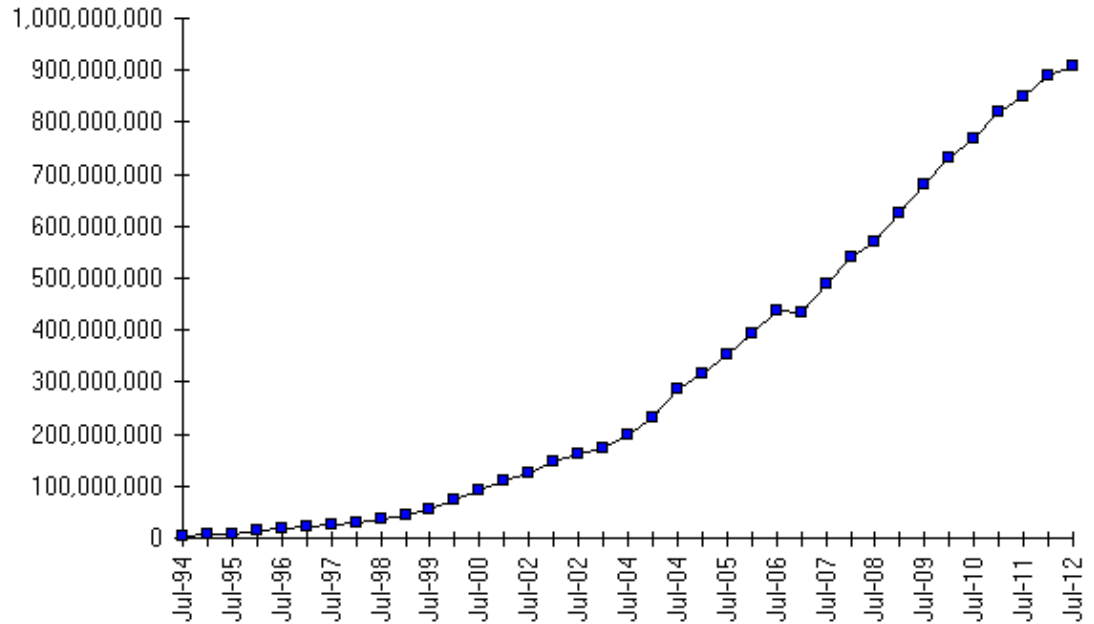

Source: Internet Systems Consortium (www.isc.org)

Internet Routing Growth

- Internet growth translates into routing table growth (even using prefixes) ...

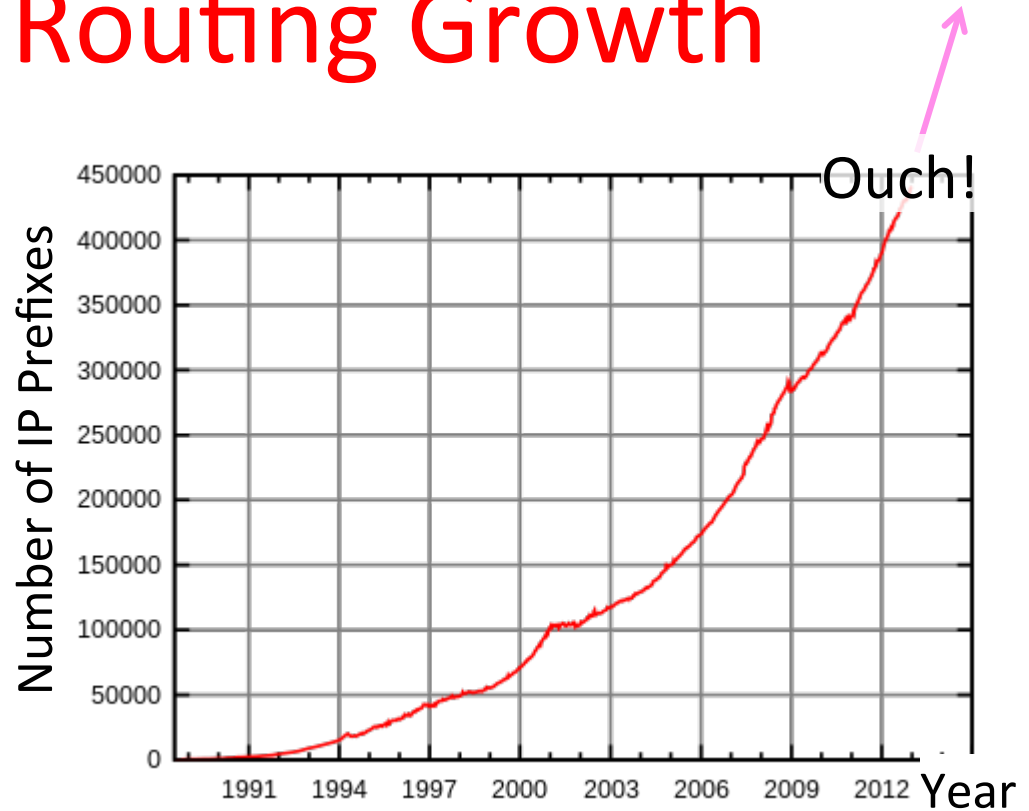

Source: By Mro (Own work), CC-BY-SA-3.0 , via Wikimedia Commons

Impact of Routing Growth

1. Forwarding tables grow
 - Larger router memories, may increase lookup time
2. Routing messages grow
 - Need to keep all nodes informed of larger topology
3. Routing computation grows
 - Shortest path calculations grow faster than the size of the network

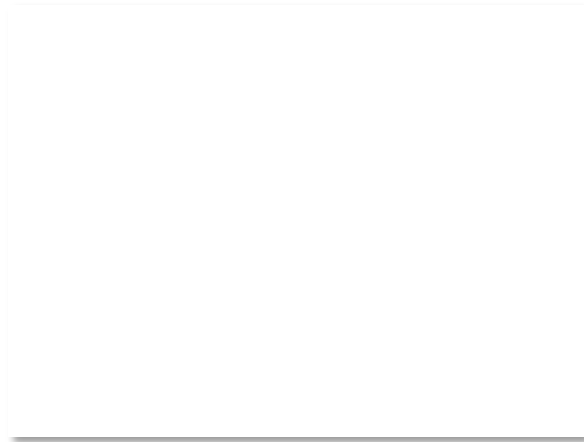

Techniques to Scale Routing

1. IP prefixes
 - Route to blocks of hosts

} Last time
2. Network hierarchy
 - Route to network regions

} This time
3. IP prefix aggregation
 - Combine, and split, prefixes

} Next time

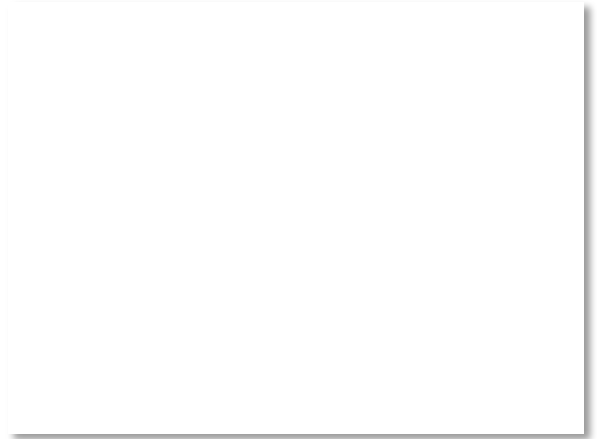

Hierarchical Routing

- Introduce a larger routing unit
 - IP prefix (hosts) ← from one host
 - Region, e.g., ISP network
- Route first to the region, then to the IP prefix within the region
 - Hide details within a region from outside of the region

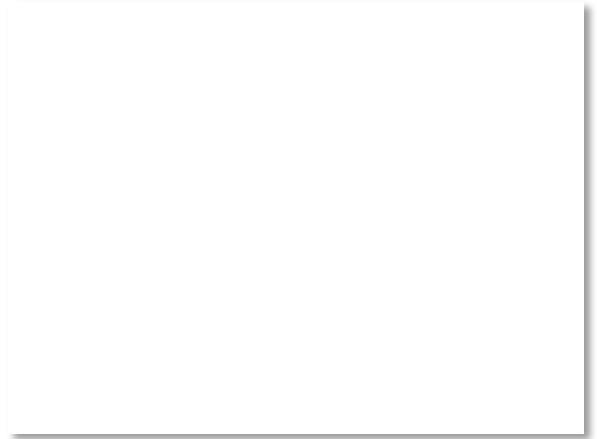

Hierarchical Routing (2)

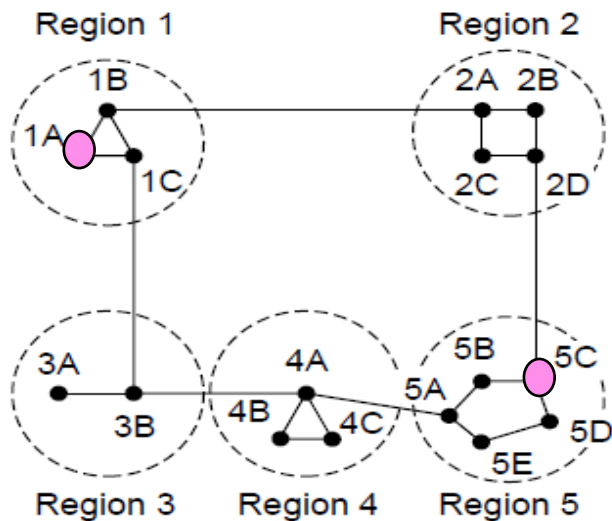

Full table for 1A

Dest.	Line	Hops
1A	-	-
1B	1B	1
1C	1C	1
2A	1B	2
2B	1B	3
2C	1B	3
2D	1B	4
3A	1C	3
3B	1C	2
4A	1C	3
4B	1C	4
4C	1C	4
5A	1C	4
5B	1C	5
5C	1B	5
5D	1C	6
5E	1C	5

Hierarchical table for 1A

Dest.	Line	Hops
1A	-	-
1B	1B	1
1C	1C	1
2	1B	2
3	1C	2
4	1C	3
5	1C	4

Hierarchical Routing (3)

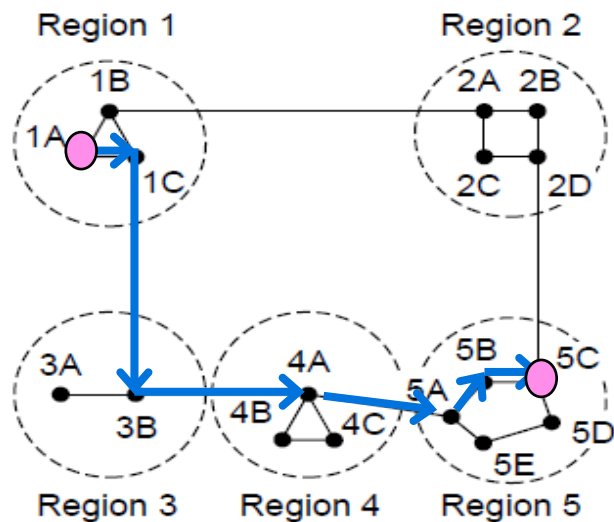

Full table for 1A

Dest.	Line	Hops
1A	—	—
1B	1B	1
1C	1C	1
2A	1B	2
2B	1B	3
2C	1B	3
2D	1B	4
3A	1C	3
3B	1C	2
4A	1C	3
4B	1C	4
4C	1C	4
5A	1C	4
5B	1C	5
5C	1B	5
5D	1C	6
5E	1C	5

Hierarchical table for 1A

Dest.	Line	Hops
1A	—	—
1B	1B	1
1C	1C	1
2	1B	2
3	1C	2
4	1C	3
5	1C	4

Hierarchical Routing (4)

- Penalty is longer paths

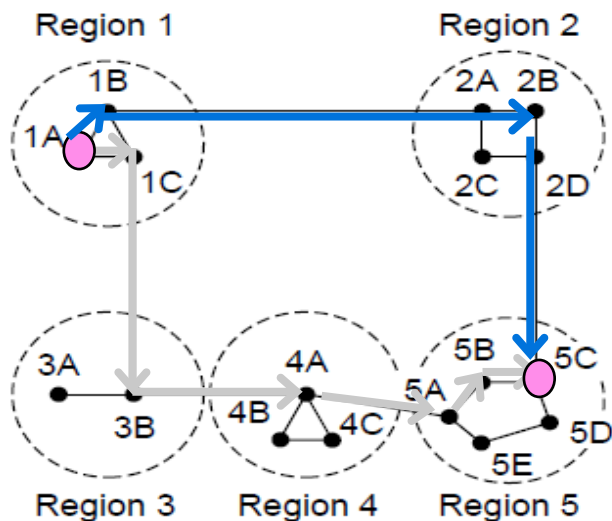

Full table for 1A

Dest.	Line	Hops
1A	-	-
1B	1B	1
1C	1C	1
2A	1B	2
2B	1B	3
2C	1B	3
2D	1B	4
3A	1C	3
3B	1C	2
4A	1C	3
4B	1C	4
4C	1C	4
5A	1C	4
5B	1C	5
5C	1B	5
5D	1C	6
5E	1C	5

Hierarchical table for 1A

Dest.	Line	Hops
1A	-	-
1B	1B	1
1C	1C	1
2	1B	2
3	1C	2
4	1C	3
5	1C	4

1C is best route to region 5, except for destination 5C

Observations

- Outside a region, nodes have one route to all hosts within the region
 - This gives savings in table size, messages and computation
- However, each node may have a different route to an outside region
 - Routing decisions are still made by individual nodes; there is no single decision made by a region



Topic

- How to help scale routing by adjusting the size of IP prefixes
 - Split (subnets) and join (aggregation)

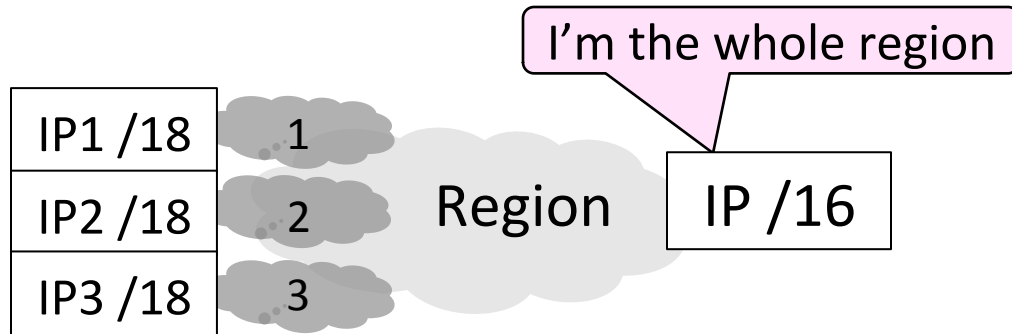

Recall

- IP addresses are allocated in blocks called IP prefixes, e.g., 18.31.0.0/16
 - Hosts on one network in same prefix
- A “/N” prefix has the first N bits fixed and contains 2^{32-N} addresses
 - E.g., a “/24” has 256 addresses
- Routers keep track of prefix lengths
 - Use it as part of longest prefix matching



Recall (2)

- IP addresses are allocated in blocks called IP prefixes, e.g., 18.31.0.0/16
 - Hosts on one network in same prefix
- A “/N” prefix has the first N bits fixed and contains 2^{32-N} addresses
 - E.g., a “/24” has 256 addresses
- Routers keep track of prefix lengths
 - Use it as part of longest prefix matching

Routers can change prefix lengths without affecting hosts

Prefixes and Hierarchy

- IP prefixes already help to scale routing, but we can go further
 - We can use a less specific (larger) IP prefix as a name for a region

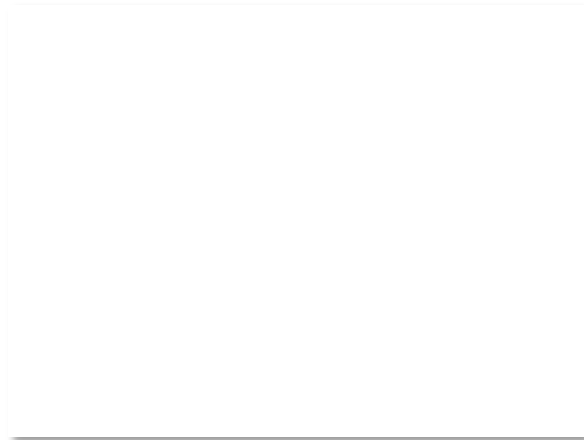
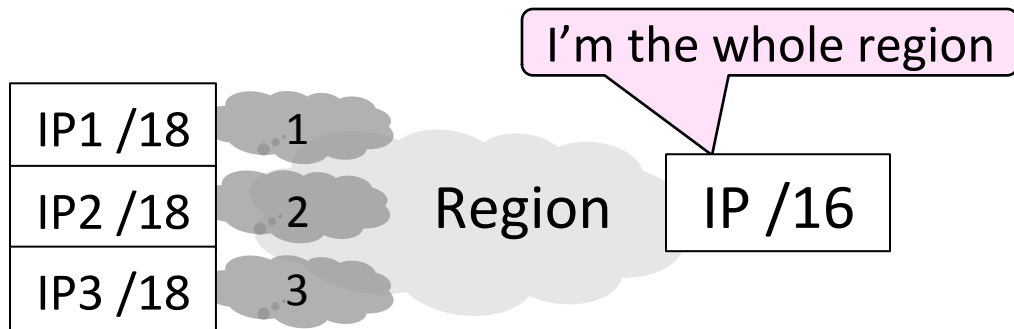

Subnets and Aggregation

- Two use cases for adjusting the size of IP prefixes; both reduce routing table
 1. Subnets
 - Internally split one large prefix into multiple smaller ones
 2. Aggregation
 - Externally join multiple smaller prefixes into one large prefix

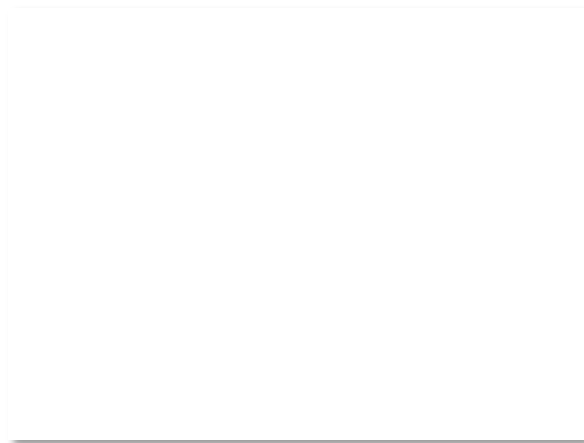

Subnets

- Internally split up one IP prefix

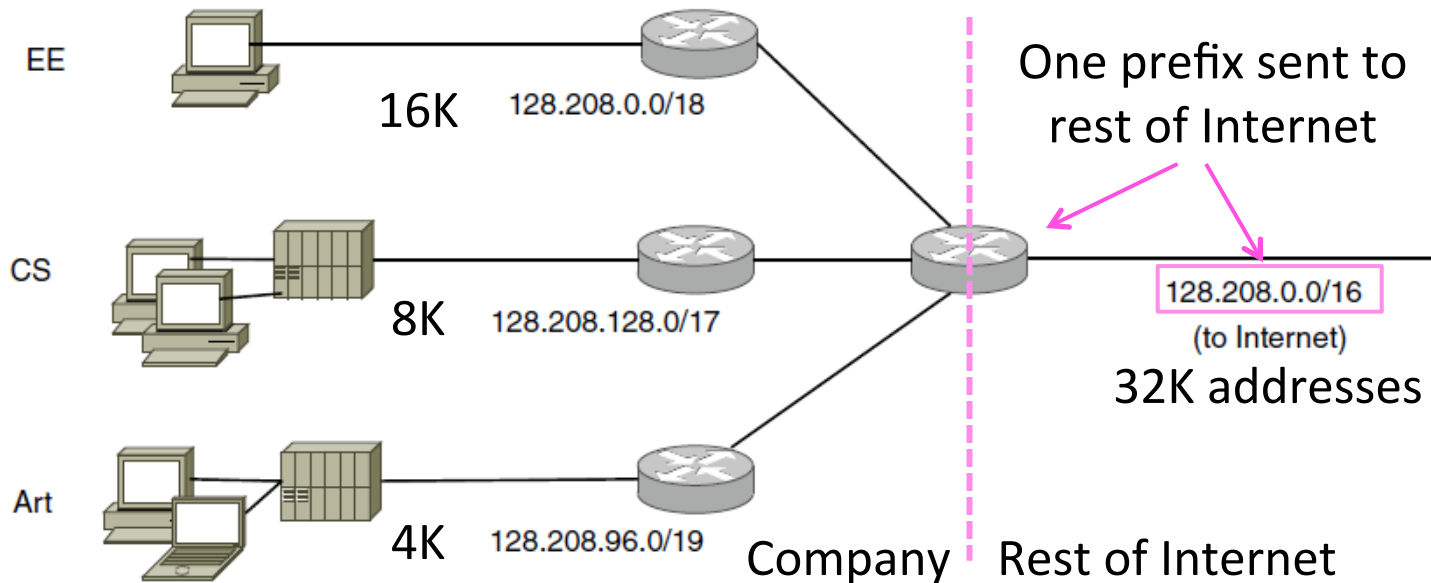

Aggregation

- Externally join multiple separate IP prefixes

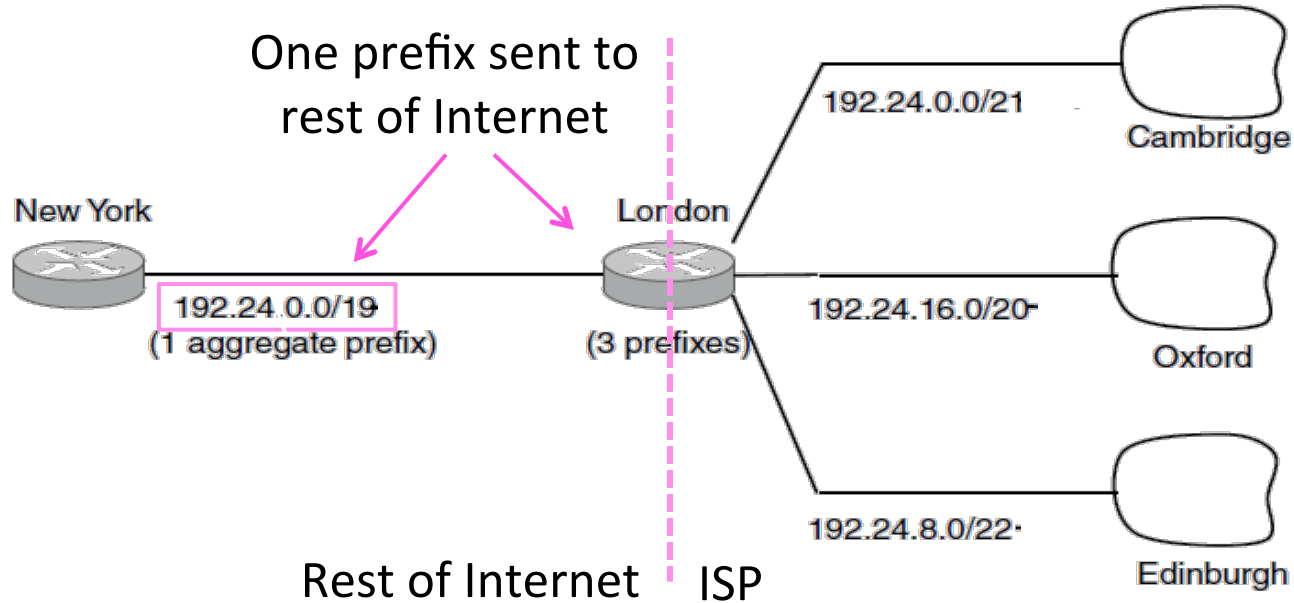

Topic

- How to route with multiple parties, each with their own routing policies
 - This is Internet-wide BGP routing

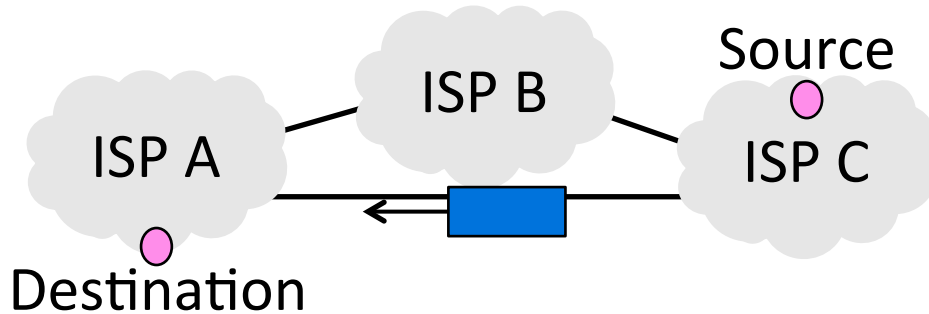

Structure of the Internet

- Networks (ISPs, CDNs, etc.) group hosts as IP prefixes
- Networks are richly interconnected, often using IXPs

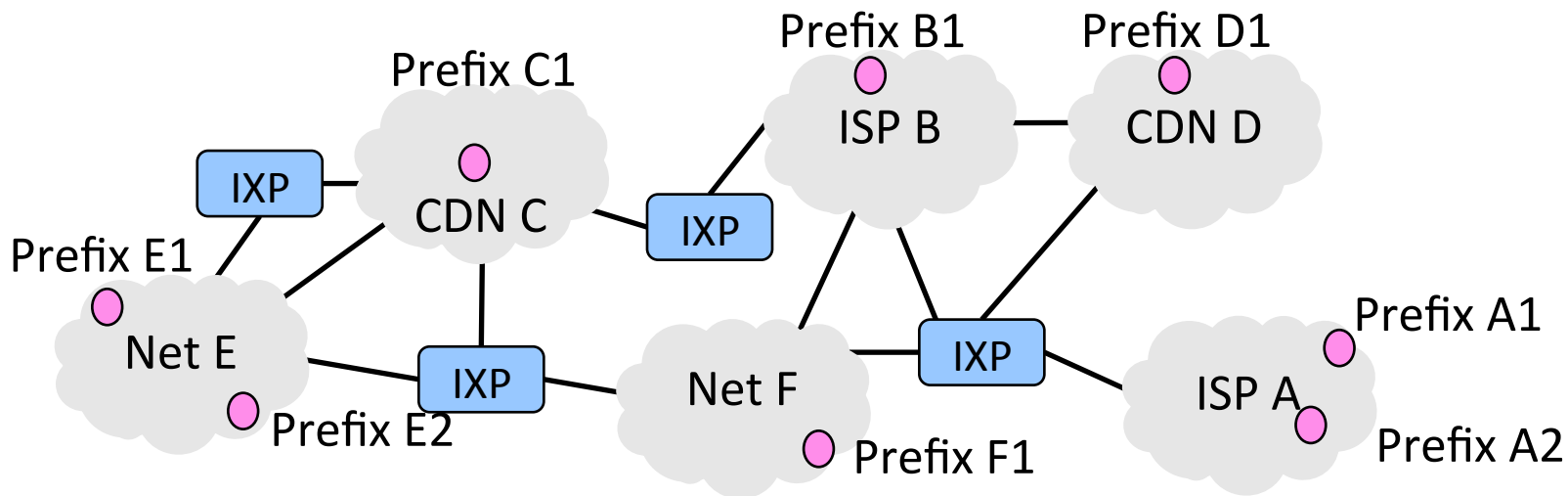

Internet-wide Routing Issues

- Two problems beyond routing within an individual network
 1. Scaling to very large networks
 - Techniques of IP prefixes, hierarchy, prefix aggregation
 2. Incorporating policy decisions
 - Letting different parties choose their routes to suit their own needs



Yikes!

Effects of Independent Parties

- Each party selects routes to suit its own interests
 - e.g, shortest path in ISP
- What path will be chosen for $A2 \rightarrow B1$ and $B1 \rightarrow A2$?
 - What is the best path?

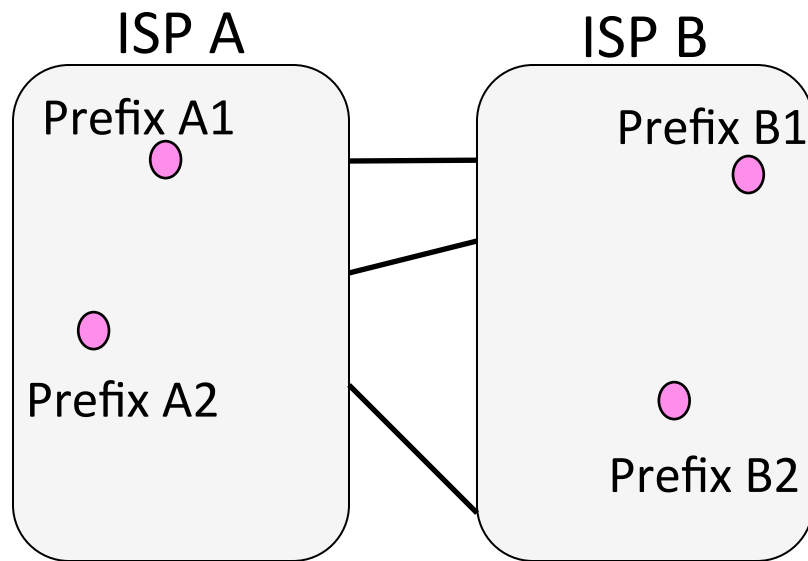

Effects of Independent Parties (2)

- Selected paths are longer than overall shortest path
 - And symmetric too!
- This is a consequence of independent goals and decisions, not hierarchy

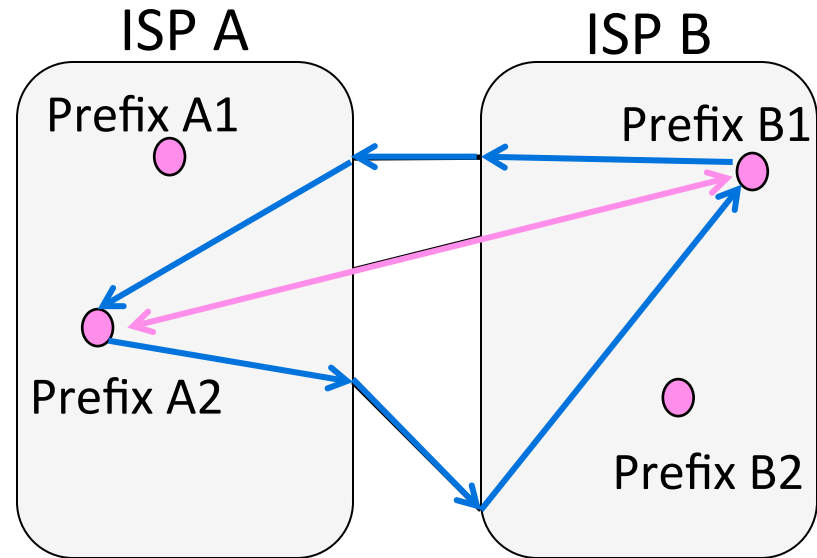

Routing Policies

- Capture the goals of different parties – could be anything
 - E.g., Internet2 only carries non-commercial traffic
- Common policies we'll look at:
 - ISPs give TRANSIT service to customers
 - ISPs give PEER service to each other

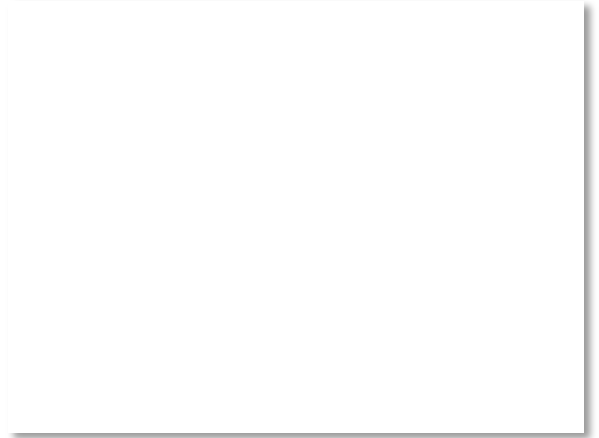

Routing Policies – Transit

- One party (customer) gets TRANSIT service from another party (ISP)
 - ISP accepts traffic for customer from the rest of Internet
 - ISP sends traffic from customer to the rest of Internet
 - Customer pays ISP for the privilege

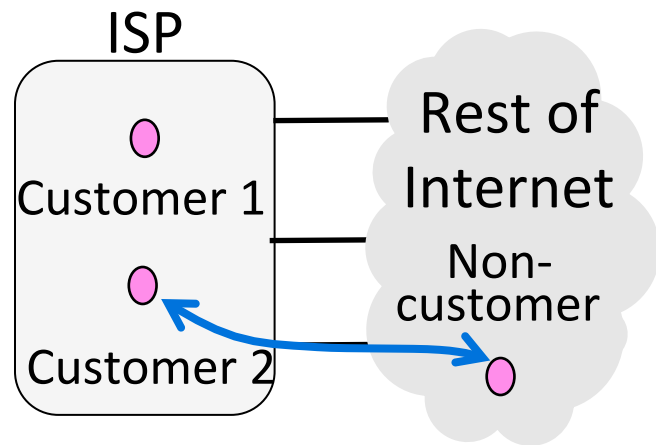

Routing Policies – Peer

- Both party (ISPs in example) get PEER service from each other
 - Each ISP accepts traffic from the other ISP only for their customers
 - ISPs do not carry traffic to the rest of the Internet for each other
 - ISPs don't pay each other

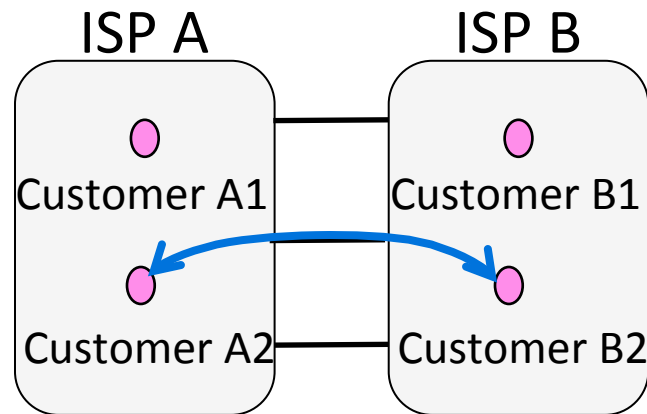

Routing with BGP (Border Gateway Protocol)

- BGP is the interdomain routing protocol used in the Internet
 - Path vector, a kind of distance vector

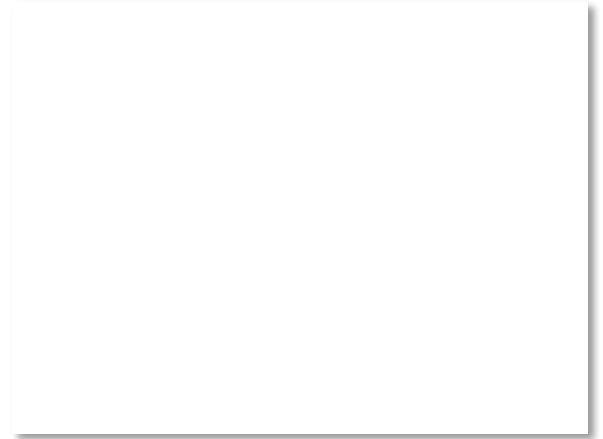
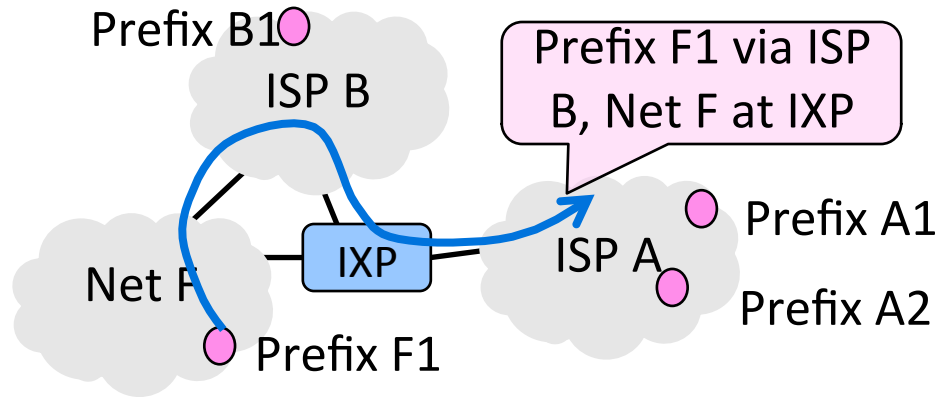

Routing with BGP (2)

- Different parties like ISPs are called AS (Autonomous Systems)
- Border routers of ASes announce BGP routes to each other
- Route announcements contain an IP prefix, path vector, next hop
 - Path vector is list of ASes on the way to the prefix; list is to find loops
- Route announcements move in the opposite direction to traffic



Routing with BGP (3)

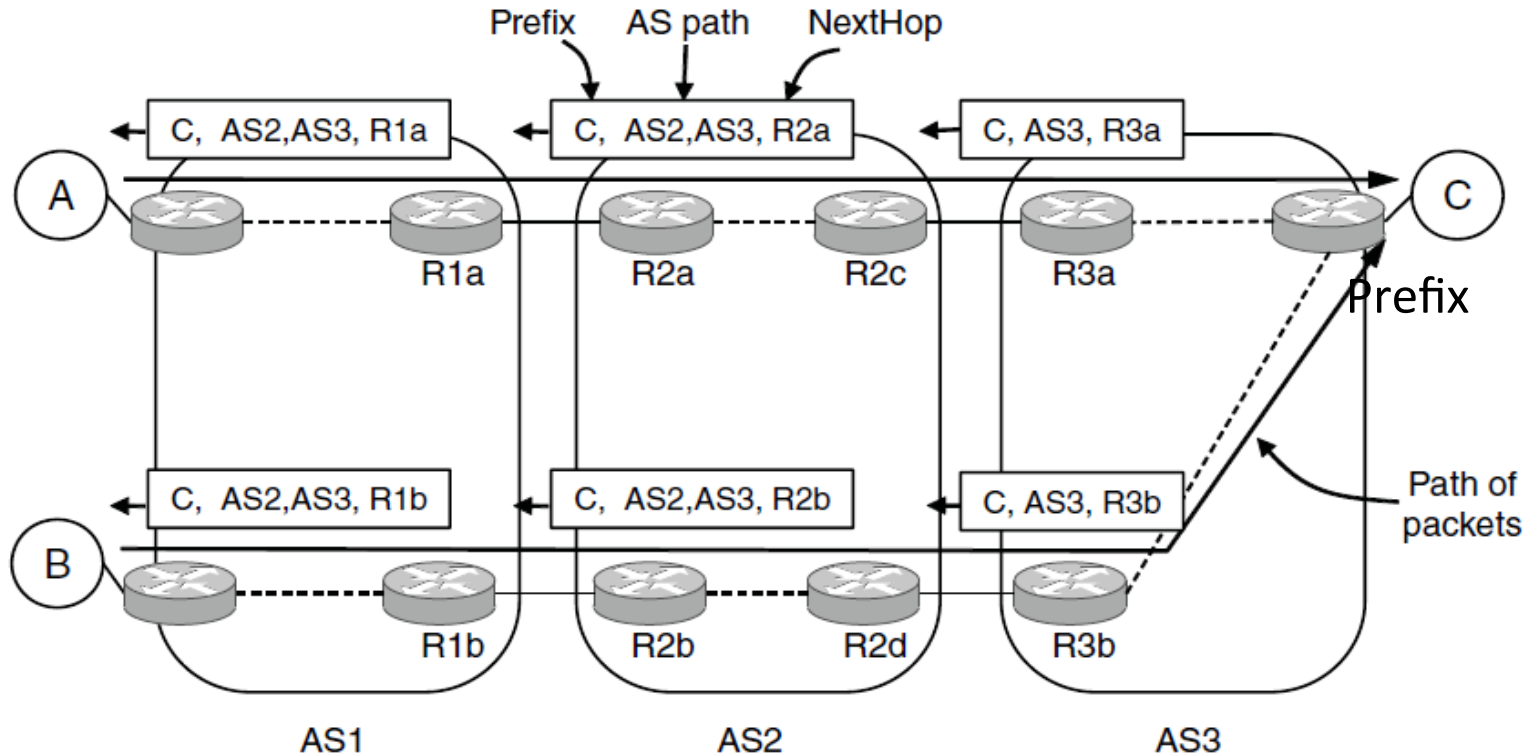

Routing with BGP (4)

Policy is implemented in two ways:

1. Border routers of ISP announce paths only to other parties who may use those paths
 - Filter out paths others can't use
2. Border routers of ISP select the best path of the ones they hear in any, non-shortest way



Routing with BGP (5)

- TRANSIT: AS1 says [B, (AS1, AS3)], [C, (AS1, AS4)] to AS2

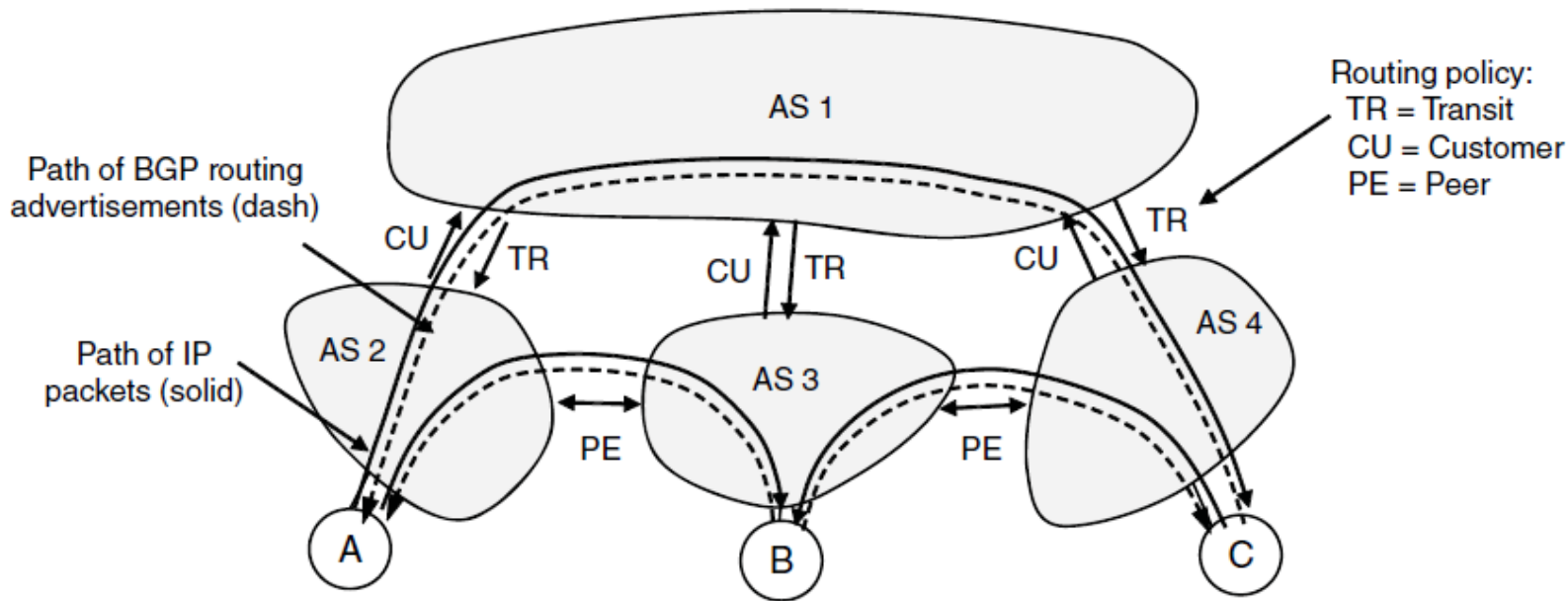

Routing with BGP (6)

- CUSTOMER (other side of TRANSIT): AS2 says [A, (AS2)] to AS1

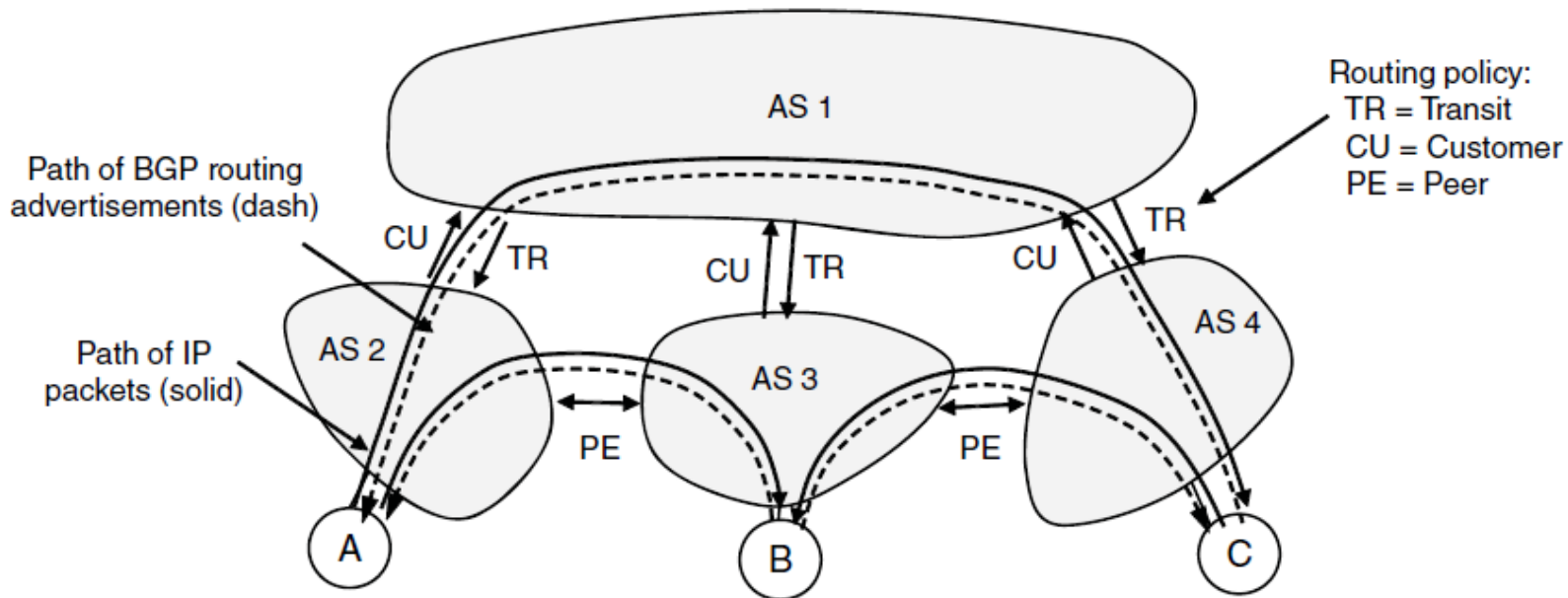

Routing with BGP (7)

- PEER: AS2 says [A, (AS2)] to AS3, AS3 says [B, (AS3)] to AS2

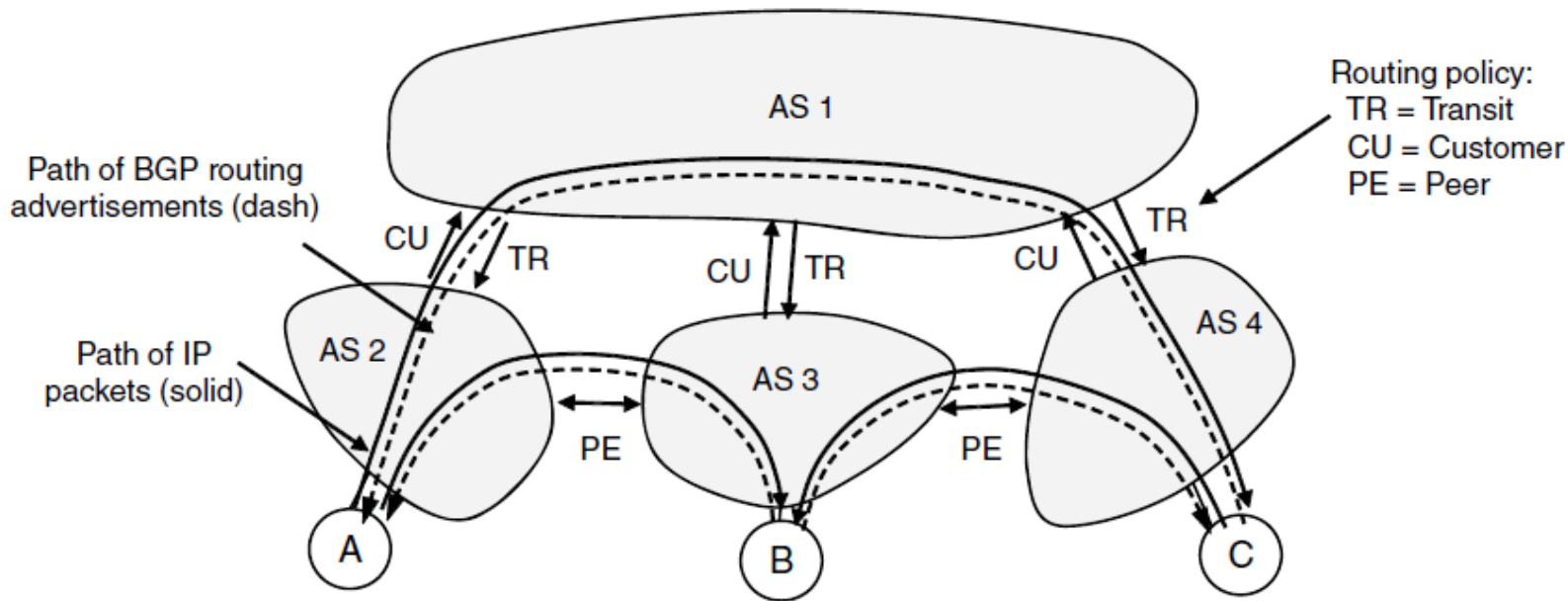

Routing with BGP (8)

- AS2 hears two routes to B (via AS1, AS3) and chooses AS3 (Free!)

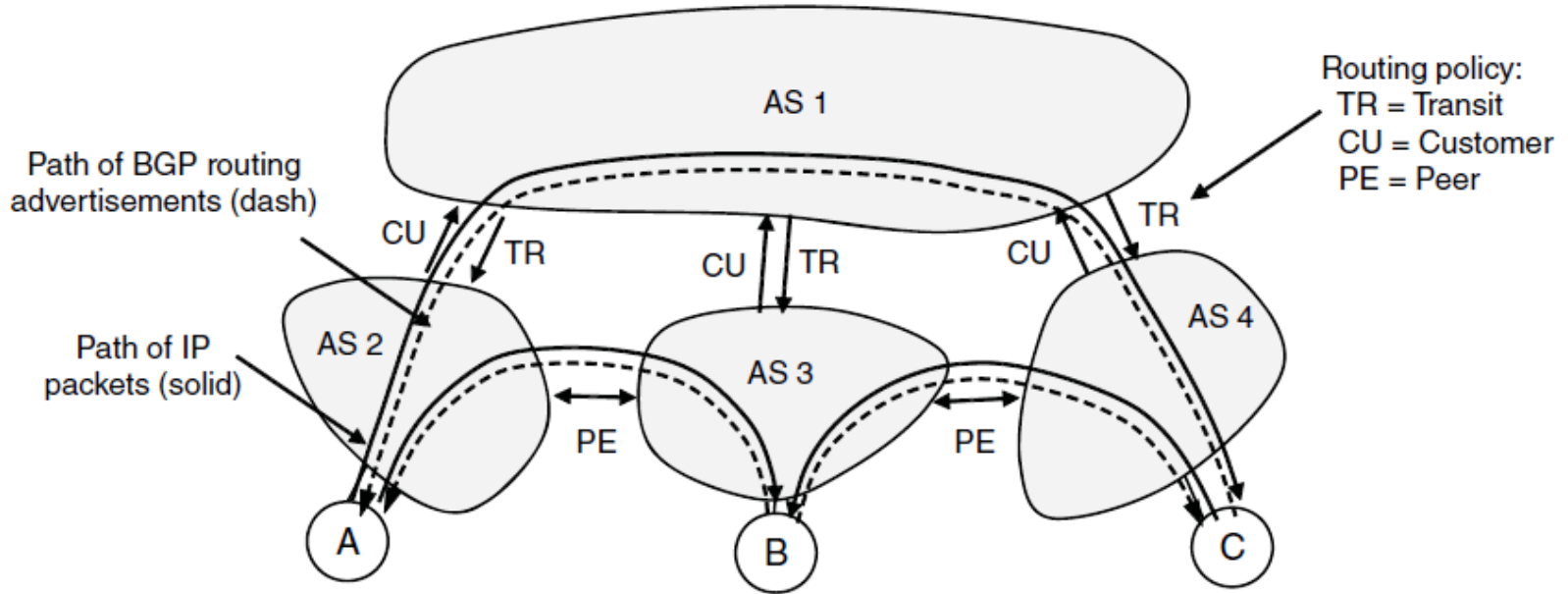

BGP Thoughts

- Much more beyond basics to explore!
- Policy is a substantial factor
 - Can we even be independent decisions will be sensible overall?
- Other important factors:
 - Convergence effects
 - How well it scales
 - Integration with intradomain routing
 - And more ...

