

Displays and framebuffers

Brian Curless
CSE 457
Autumn 2010

1

Reading

Required

- ♦ Angel, section 1.2, chapter 2
- ♦ Hearn & Baker, handout

Optional

- ♦ OpenGL Programming Guide (the "red book" – available online):
 - First four sections of chapter 2
 - First section of chapter 6
- ♦ Foley et al., sections 1.5, 4.2-4.5
- ♦ I.E. Sutherland. Sketchpad: a man-machine graphics communication system. *Proceedings of the Spring Joint Computer Conference*, p. 329-346, 1963.
- ♦ T.H. Myer & I.E. Sutherland. On the design of display processors. *Communications of the ACM* 11(6): 410-414, 1968.

2

Modern graphics systems

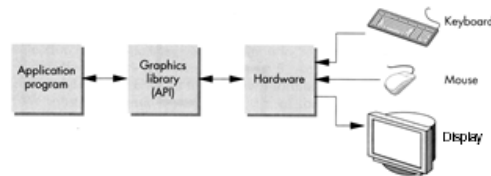

Current graphics systems consist of:

- An application, which talks to a...
- Graphics library (e.g., OpenGL or Direct3D), which talks to the...
- Graphics hardware

The graphics hardware can do a lot of fancy work these days. We'll take a brief tour, starting from the display...

3

Light

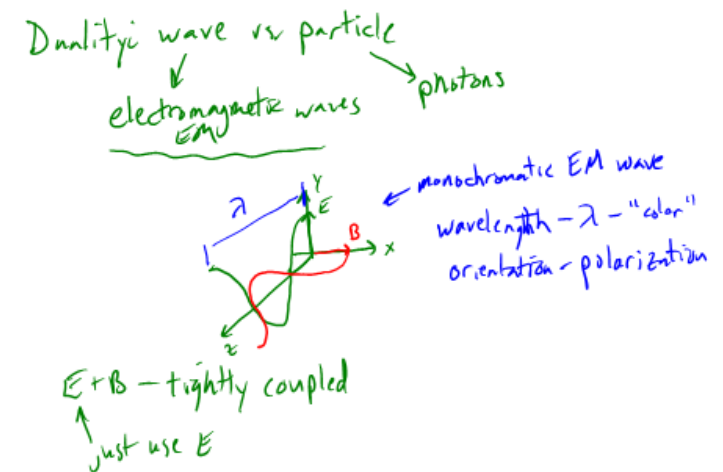

4

Polarization



linearly polarized



Linear polarizer (filter)

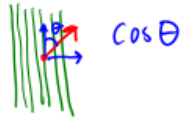

5

Liquid Crystal Display

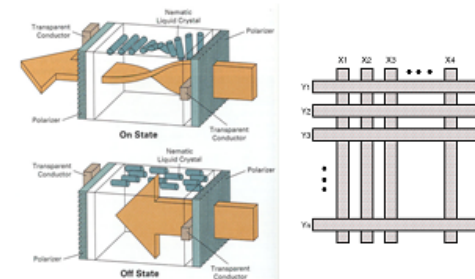

Laptops typically use **liquid crystal displays (LCD's)**.

- Light enters a **vertical polarizer**
- **Nematic crystal** twists light based on applied voltage (more voltage, less twisting)
- Light passes through **horizontal polarizer**

Passive matrix displays use a matrix of electrodes to control the voltages. Problem: slow to switch, overflows.

Active matrix displays have a transistor at each cell. They use a faster switching crystal and transistors that hold charge and prevent overflow.

6

Color

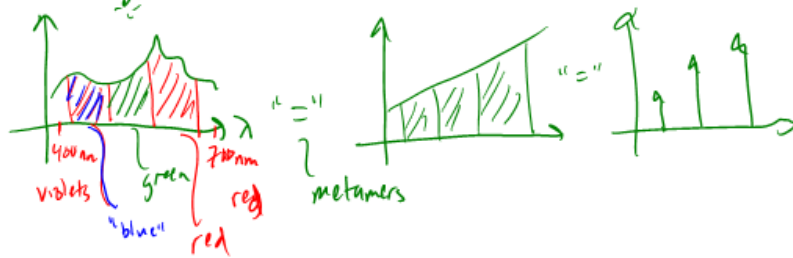

7

Additive color mixing

All colors on a display are produced using combinations of red, green, and blue.

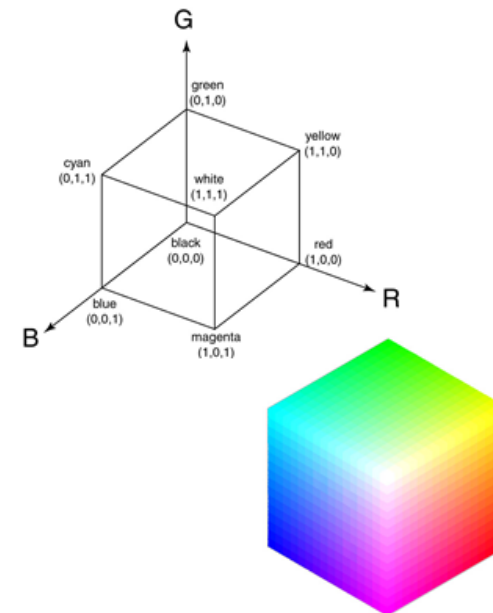

8

Anatomy of an RGB image

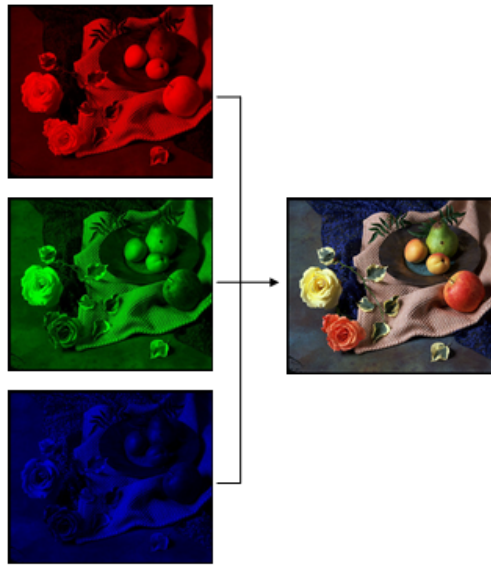

9

LCD Color

Color is obtained using color filters:

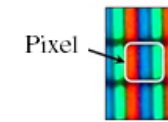

Pixel is one region on the display corresponding to one color sample of an image being shown.

Our eyes average the closely spaced RGB colors spatially to create the impression of a composite color at each pixel.

10

Liquid Crystal Display

Backlighting can be fluorescent or LED:



The lighting is arranged into a column or a sparse array and then diffused evenly:

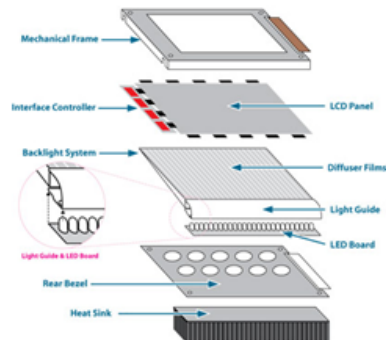

[www.futureelectronics.com]

11

Liquid Crystal Display

Backlighting is generally intended to be even, definitely not one light per LCD cell (or color filter).

But, some new technology is starting to use spatially varying lighting to increase the brightness range at different pixels:

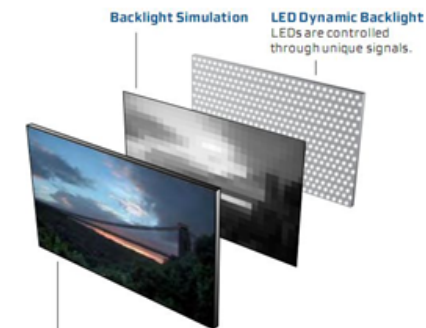

LCD
Provides color, resolution, and contrast. Contrast and image created by combining LED and LCD images.

[Dolby Vision High Dynamic Range Display]

12

3D Displays

So-called 3D displays are all the rage now for movies and soon for televisions.

Much of our perception of 3D comes from stereo vision: each eye sees a different view of the world.

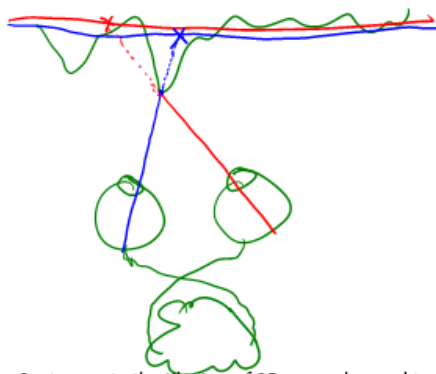

So, to create the illusion of 3D, we only need to show each eye an image of a scene created from that eye's point of view!

3D Displays, cont'd

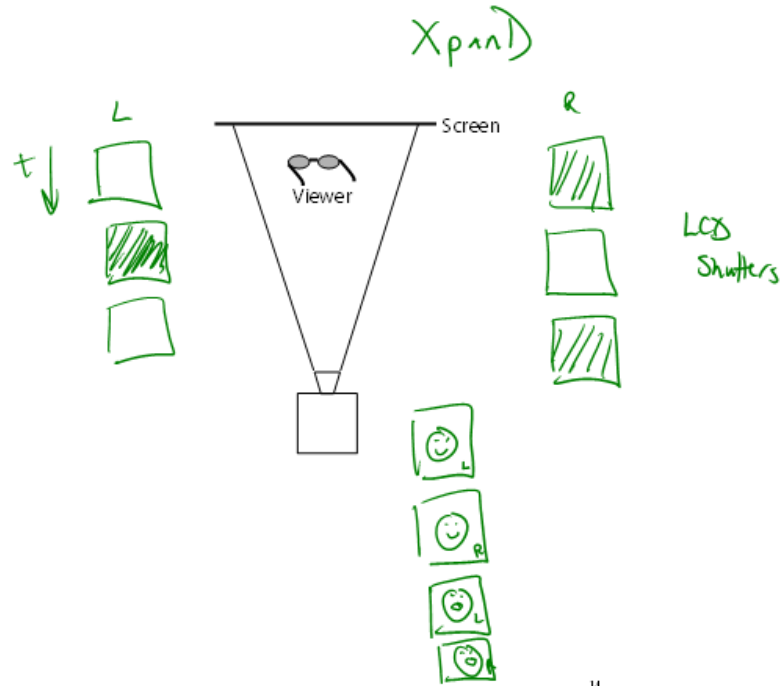

3D Displays, cont'd

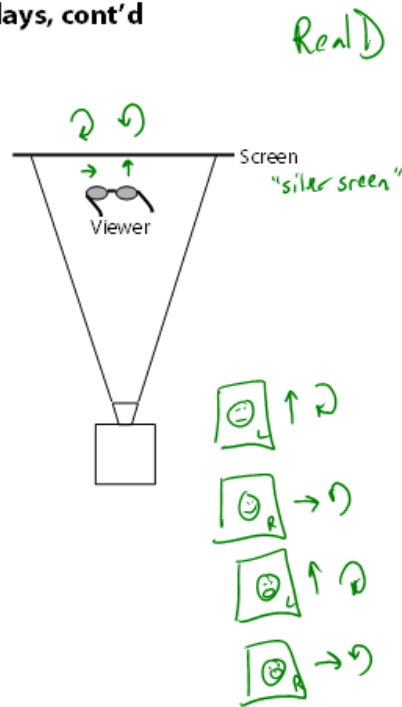

3D Displays, cont'd

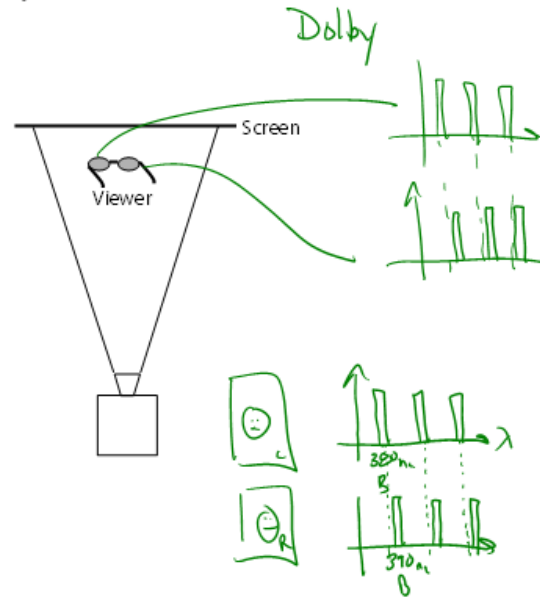

RGB framebuffer

The brightness of each LCD element is controlled by a dedicated memory array called a **framebuffer**.

Each element of the framebuffer is associated with a single **pixel** on the screen.

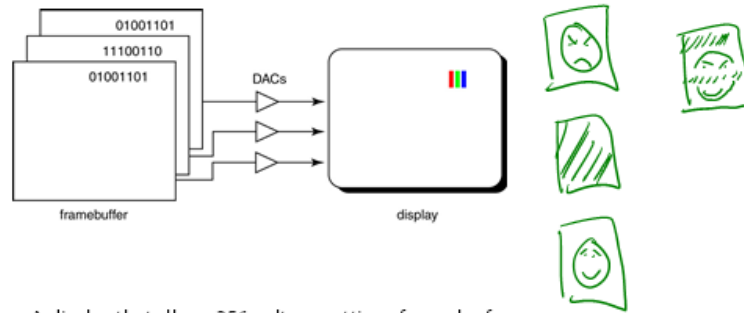

A display that allows 256 voltage settings for each of R, G, and B is known as a **full-color system**.

The description of each color in framebuffer memory is known as a **channel**.

17

Double-buffering

Q: What happens when you write to the framebuffer while it is being displayed on the monitor?

Double-buffering provides a solution.

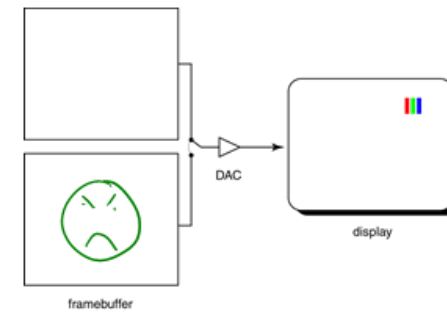

18

OpenGL

The API we'll be using for drawing to the framebuffer is OpenGL.

For 2D graphics, OpenGL lets you specify colors of primitives and then draw them to the screen. Typical primitives include:

- Points
- Lines
- Unfilled polygons
- Filled polygons

You just name a color, declare the primitive type, and specify the vertices, and OpenGL does the rest.

OpenGL also supports "alpha" blending. A typical operation is a linear mixture that blends a new color into the framebuffer:

$$F_{\text{new}} = \alpha C + (1 - \alpha) F_{\text{old}}$$

$\begin{bmatrix} C_r \\ C_g \\ C_b \end{bmatrix}$ $\begin{bmatrix} F_{\text{old},r} \\ F_{\text{old},g} \\ F_{\text{old},b} \end{bmatrix}$

19