

New slides posted ~ 1 minute ago  
(one extra slide at start with "what you need to wrap up fhw2")

# P vs. NP and Reductions

CSE 417 Winter 21  
Lecture 20

# Want to wrap up HW6?

Here's what you need to know from these slides for HW6:

1. How to do a reduction (see the example/advice in slides 15-25)
2. To show a problem is NP-hard, you can reduce FROM 3-SAT, 3-coloring, or Hamiltonian Path TO your problem. (the problems on the homework can be done with these – definitions in these slides).
3. Writing a polynomial time algorithm for an NP-hard (or NP-complete) problem will show  $P = NP$ .

More practice coming Friday, but these slides should be enough.

# Rest of this week

What problems do we **not** know how to solve efficiently?

And how do we demonstrate it?

We need A LOT of definitions today.

We'll bold new words and use them in context.

( If you don't recognize a word I say, please ask in chat right away  
(someone is watching chat)

If you're watching asynchronously, pause and back up to find the word.

There are too many words to infer from context if you missed one.

# How do we know a problem is hard?

At this point in the quarter, you've probably at least once been banging your head against a problem.

For so long that you began to thought "there's no way there's actually an efficient algorithm for this problem."

That wasn't true for any of the problems we gave you so far.

But it **is** true for some problems. At least we think it is.

The next two lectures are: what problems do we think there aren't efficient algorithms for, and how do we tell?

# Some definitions

A problem is a set of inputs and the correct outputs.

↳ "Find a Minimum Spanning Tree" is a problem.

Input is a graph, output is the MST.

"Tell whether a graph is bipartite" is a problem.

Input is a graph, output is "yes" or "no"

"Find the "maximum subarray sum" is a problem.

Input is an array, output is the number that represents the largest sum of a subarray.

# Some definitions

An **instance** is a single input to a problem.

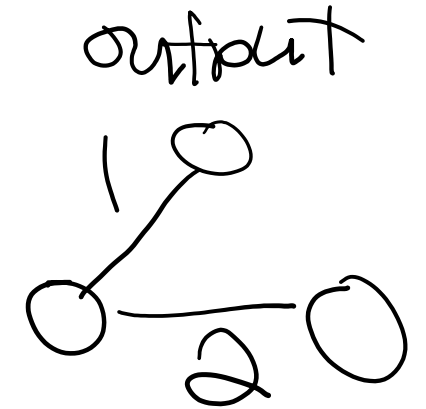

A single, particular graph is an instance of the MST problem

A single, particular graph is an instance of the bipartite-checking problem.

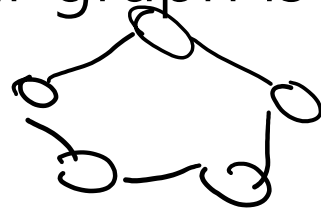

no

A single, particular array is an instance of the maximum subarray sum problem.



# Decision Problems

Our goal is to divide problems into solvable/not solvable.  
We're going to talk about **decision problems**.

Problems that have a "yes" or "no" answer. (a correct algorithm has a Boolean return type)

Why?

Theory reasons (ask me later).

But it's not too bad

most problems can be rephrased as very similar decision problems.

E.g. instead of "find the shortest path from  $s$  to  $t$ " ask

"Is there a path from  $s$  to  $t$  of length at most  $k$ ?"

# "Ranking" difficulty of problems

We'll use "reductions" to tell whether one problem is harder than another.

## Reduction (informally)

Using an algorithm for Problem B to solve Problem A.

In that case, we'll say "A reduces to B"

In difficulty (for us, as algorithm designers),  $A \leq B$

ANY algorithm for  $B$  solves  $A$ .  $A$  is no harder to solve than  $B$ .

$A$  might be easier (maybe there's another way to solve  $A$  without  $B$ ) or they might be about the same (maybe  $B \leq A$  too!)



# Reductions

Even less formally

Calling a library.

If you wrote a library to solve problem  $B$

And your algorithm for  $A$  calls that library,

Then  $A \leq B$  ( $A$  reduces to  $B$ ).

# Baseball Selection (from Monday)

$g_{ij}$	Angels	Rangers	Mariners	A's
Angels	-	5	3	4
Rangers	5	-	4	3
Mariners	3	4	-	5
A's	4	3	5	-

Team	w	g	P
Angels	81	12	93
Rangers	80	12	92
Mariners	70	12	82
A's	69	12	81

Transform Input

Max-Flow Algorithm

Transform Output



# More Previous Examples

On Homework 1, you reduced “stable matchings with unacceptable pairs and unequal numbers of agents” to “[standard] stable matching”

On Homework 4, you (might have) reduced “finding a labeling with the minimum number of 0s on an unlabeled tree” to “2-coloring”

On Monday, we reduced “telling whether the Mariners could win the division” to “finding a maximum flow”

# A Formal Definition

We need a formal definition of a reduction.

We will say " $A$  reduces to  $B$  in polynomial time" (or " $A$  is polynomial time reducible to  $B$ " or " $A$  reduces to  $B$ " or " $A \leq B$ ") if:

There is an algorithm to solve problem  $A$ , which, if given access to a polynomial-time algorithm for problem  $B$ , runs in polynomial time overall (**including** the library's running time!!!).

# Let's Do A Reduction

4 steps for reducing (decision problem)  $A$  to problem  $B$ .

1. Describe the reduction itself (i.e. the algorithm, with a call to a library for problem  $B$ )

2. Make sure the running time would be polynomial (usually skip writing out this step).

3. Argue that if the correct answer (to the instance for  $A$ ) is YES, then our algorithm answers YES.

4. Argue that if the correct answer (to the instance for  $A$ ) is NO, then our algorithm answers NO.

# Reduce 2-coloring to 3-coloring

What's 3-coloring?

## 3-coloring

Input: Undirected Graph  $G$

Output: `True` if the vertices of  $G$  can be labeled with red, green, and blue so that no edge has both of its endpoints colored the same color. `False` if it cannot.

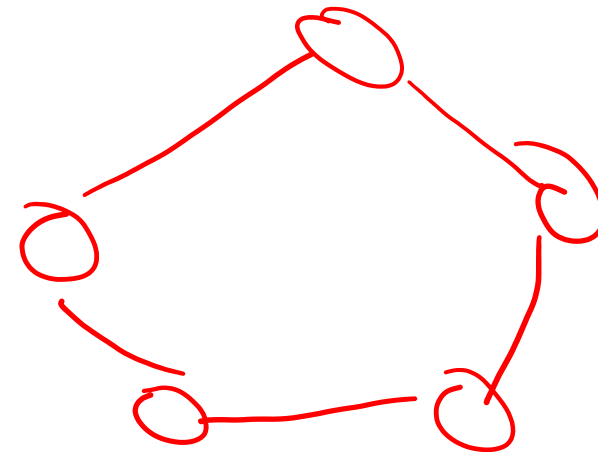
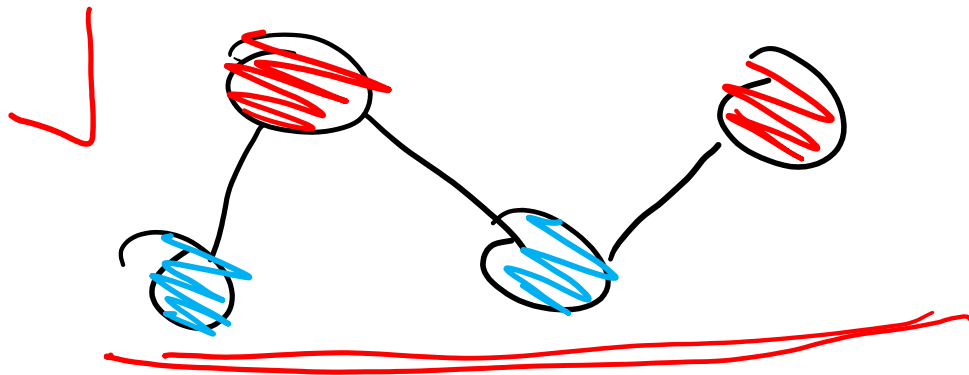

# Reduce 2-coloring to 3-coloring

↳ decide if this graph 2-colorable

Given a graph  $G$ , figure out whether it can be 2-colored, by using an algorithm that figures out whether it can be 3-colored.

Usual outline:

Transform  $G$  into an input for the 3-coloring algorithm

Run the 3-coloring algorithm

Transform the answer from the 3-coloring algorithm into the answer for  $G$  for 2-coloring

# Reduction



If we just ask the 3-coloring algorithm about  $G$ , it might use 3 colors...we can't get it to use just 2...

...unless...

Unless we force it not to, by adding extra vertices that **force** the 3-coloring algorithm to "use up" one color on the extra vertices, leaving only two colors for the "real" vertices.

Add an extra vertex  $v$ , and attach it to **everything** in  $G$ .



# Reduction

2ColorCheck (Graph G)

(Let H be a copy of G

(Add a vertex to H, attach it to all other vertices.

→ Bool answer = 3ColorCheck(H)

→ return answer //don't need any modification!

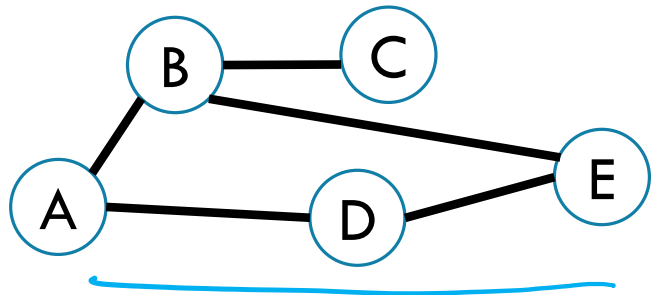

Transform Input

3ColorCheck algorithm

Transform Output

# Correctness?

```
2ColorCheck(Graph G)
```

```
    Let H be a copy of G
```

```
    Add a vertex to H, attach it to all  
    other vertices.
```

```
    Bool answer = 3ColorCheck(H)
```

```
    return answer
```

TWO statements to prove: ("two directions")

If the correct answer for  $G$  is YES, then we say YES

If the correct answer for  $G$  is NO, then we say NO

# Correctness?

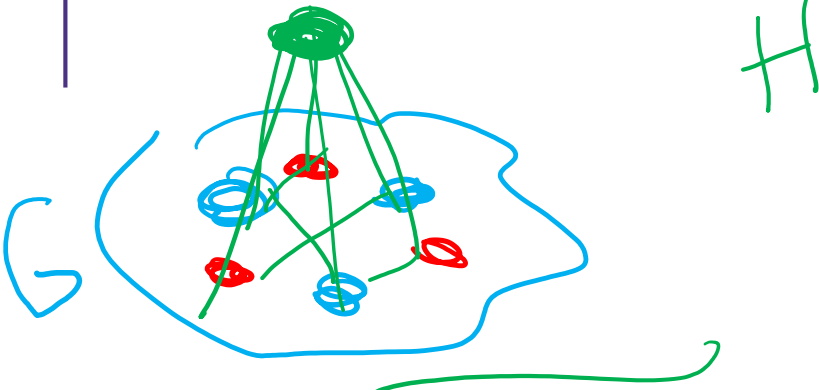

```
2ColorCheck(Graph G)
```

```
  Let H be a copy of G
```

```
  Add a vertex to H, attach it to all  
  other vertices.
```

```
  Bool answer = 3ColorCheck(H)
```

```
  return answer
```

TWO statements to prove: ("two directions")

If the correct answer for G is YES, then we say YES

If  $G$  is 2-colorable, then  $H$  will be 3-colorable – you can extend a 2-color labeling of  $G$  to 3 colors on  $H$  by making the new vertex the new color. All the edges in  $G$  have different colors (because we started with a 2-coloring) and any added edge has different endpoints (because  $v$  is a new color) so 3ColorCheck returns True and we return True!

If the correct answer for G is NO, then we say NO

# Correctness?

```
2ColorCheck(Graph G)
```

```
    Let H be a copy of G
```

```
    Add a vertex to H, attach it to all  
    other vertices.
```

```
    Bool answer = 3ColorCheck(H)
```

```
    return answer
```

TWO statements to prove: ("two directions")

If the correct answer for  $G$  is YES, then we say YES

The new vertex can be a new color!

If the correct answer for  $G$  is NO, then we say NO

So we can't 2-color  $G$ . That's going to be hard to work with.

Take the contrapositive!!

# Correctness?

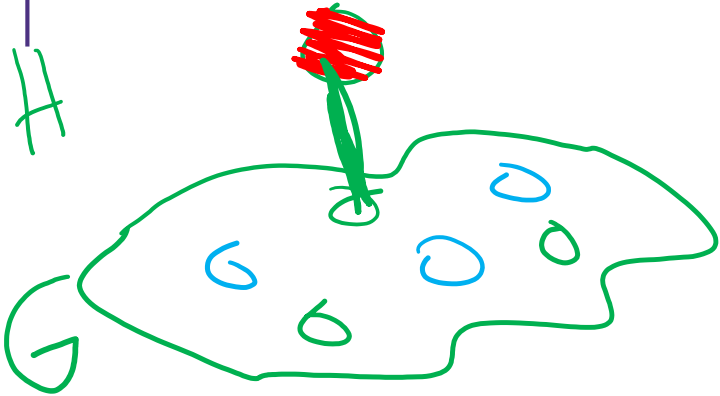

```
2ColorCheck(Graph G)
```

```
  Let H be a copy of G
```

```
  Add a vertex to H, attach it to all  
  other vertices.
```

```
  Bool answer = 3ColorCheck(H)
```

```
  return answer
```

TWO statements to prove: ("two directions")

If the correct answer for  $G$  is YES, then we say YES

The new vertex can be a new color!

If the correct answer for  $G$  is NO, then we say NO

We want to show instead: If we say YES, then the correct answer is YES.

If we say YES, then  $3ColorCheck(H)$  must have returned YES, what does a 3-coloring of  $H$  look like? The added vertex must be a different color than all the other vertices (otherwise it's not a valid coloring – there's an edge between the added vertex and all others). So deleting the added vertex we get a 2-coloring of  $G$ . So the right answer is YES!!

# Correctness

## Two DIFFERENT statements

Correct Answer YES  $\rightarrow$  Our algorithm says YES

If  $G$  is 2-colorable, then  $H$  will be 3-colorable – you can extend a 2-color labeling of  $G$  to 3 colors on  $H$  by making the new vertex the new color. All the edges in  $G$  have different colors (because we started with a 2-coloring) and any added edge has different endpoints (because  $v$  is a new color) so 3ColorCheck returns True and we return True!

Our algorithm says YES  $\rightarrow$  Correct Answer YES

We want to show instead: If we say YES, then the correct answer is YES.

If we say YES, then 3ColorCheck( $H$ ) must have returned YES, what does a 3-coloring of  $H$  look like? The added vertex must be a different color than all the other vertices (otherwise it's not a valid coloring – there's an edge between the added vertex and all others). So deleting the added vertex we get a 2-coloring of  $G$ . So the right answer is YES!!

# Write two separate arguments

You need to show **both** “we won’t get any false positives” and “we won’t get any false negatives.”

To make sure you handle both directions, I **strongly** recommend:

1. Always do two separate proofs (don’t try to prove both directions at once, don’t refer back to the prior proof and say “for the same reason”).
2. Don’t use contradiction (it’s easy to start from the wrong spot and accidentally prove the same direction twice without realizing it).
3. Follow one of the four pairs on the next slide (don’t accidentally take a contrapositive wrong)



# Argument Outlines

## Most common

If the correct answer is YES, then our algorithm says YES.

And If our algorithm says YES, then the correct answer is YES

## Less common but sometimes:

If our algorithm says NO, then the correct answer is NO.

And If our algorithm says YES, then the correct answer is YES

## OR

If the correct answer is YES, then our algorithm says YES.

And If the correct answer is NO, then our algorithm says NO

## Works, but rarely the best:

If our algorithm says NO, then the correct answer is NO.

And If the correct answer is NO, then our algorithm says NO

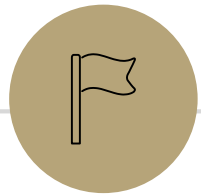

## Back to Problem Ranking

---

# P (can be solved efficiently)

## P (stands for “Polynomial”)

The set of all decision problems that have an algorithm that runs in time  $O(n^k)$  for some constant  $k$ .

The decision version of all problems we've solved in this class are in P.

*n size of the input*  
P is an example of a “complexity class”

A set of problems that can be solved under some limitations (e.g. with some amount of memory or in some amount of time).

Problems go in complexity classes. Not algorithms.  
We're comparing problem difficulty, not algorithm quality.

# NP

$$P \subseteq NP$$

Our second set of problems have the property that "I'll know it when I see it"  
We're looking for **something**, and if someone shows it to me, we can recognize it quickly (it just might be hard to find)

## NP (stands for "nondeterministic polynomial")

The set of all decision problems such that for every YES-instance, there is a certificate for that instance which can be verified in polynomial time.

A "verifier" takes in: an instance of the NP problem, and a "proof"  
And returns "true" if it received a valid proof that the instance is a YES instance, and "false" if it did not receive a valid proof

NP problems have "verifiers" that run in polynomial time.

Do they have **solvers** that run in polynomial time? The definition doesn't say.

# NP

Our second set of problems have the property that “I’ll know it when I see it”  
We’re looking for **something**, and if someone shows it to me, we can recognize it quickly (it just might be hard to find)

## NP (stands for “nondeterministic polynomial”)

The set of all decision problems such that for every YES-instance, there is a certificate for that instance which can be verified in polynomial time.

If you have a “YES” instance, a little birdy can magically find you this certificate-thing, and you’ll say “Oh yeah, that’s totally a yes instance!”

What if it’s a NO instance? No guarantee.

# NP

**NP (stands for “nondeterministic polynomial”)**

The set of all decision problems such that if the answer is YES, there is a proof of that which can be verified in polynomial time.

Decision Problems such that:

If the answer is YES, you can prove the answer is yes by  
Being given a “proof” or a “certificate”  
Verifying that certificate in polynomial time.

What certificate would be convenient for short paths?  
The path itself. Easy to check the path is really in the graph and really short.



Light Spanning Tree:  
Is there a spanning tree of graph  $G$  of weight at most  $k$ ?

The spanning tree itself.  
Verify by checking it really connects every vertex and its weight.

3-Coloring:

Can you color vertices of a graph red, blue, and green so every edge has differently colored endpoints?

The coloring.  
Verify by checking each edge.

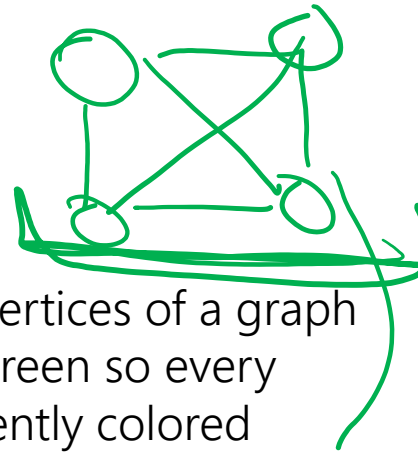

Large flow:  
Is there a flow from  $s$  to  $t$  in  $G$  of value at least  $k$ ?

The flow itself.  
Verify the capacity constraints, conservation, and that flow value at least  $k$ .

# NP

Our second set of problems have the property that “I’ll know it when I see it”  
We’re looking for **something**, and if someone shows it to me, we can recognize it quickly (it just might be hard to find)

## NP (stands for “nondeterministic polynomial”)

The set of all decision problems such that if the answer is YES, there is a proof of that which can be verified in polynomial time.

It’s a common misconception that NP stands for “not polynomial”

Never, ever, ever, ever say “NP” stands for “not polynomial”

Please

Every time someone says that, a theoretical computer scientist sheds a single tear  
(That theoretical computer scientist is me)

# P vs. NP

## P vs. NP

**Are P and NP the same complexity class?**

**That is, can every problem that can be verified in polynomial time also be solved in polynomial time.**

If you'll know it when you see it, can you also search to find it efficiently?

No one knows the answer to this question.

In fact, it's the biggest unsolved question in Computer Science.



# Some New Problems

Here are some new problems. Are they in NP?

If they're in NP, what is the "certificate" when the answer is yes?

COMPOSITE – given an integer  $n$  is it composite (i.e. not prime)?

MAX-FLOW – find a maximum flow in a graph.

VERTEX-COVER – given a graph  $G$  and an integer  $k$ , does  $G$  have a vertex cover of size at most  $k$ ?

NON-3-Color – given a graph  $G$ , is it not 3-colorable?

# Some New Problems

COMPOSITE – given an integer  $n$  is it composite (i.e. not prime)?

In  $NP$  (certificate is factors).

MAX-FLOW – find a maximum flow in a graph.

Not in  $NP$  (not a decision problem)

VERTEX-COVER – given a graph  $G$  and an integer  $k$ , does  $G$  have a vertex cover of size at most  $k$ ?

In  $NP$  (certificate is cover)

NON-3-Color – given a graph  $G$ , is it not 3-colorable?

Not known to be in  $NP$ .

# Hard Problems

Let's say we want to figure out if every problem in NP can actually be solved efficiently.

We might want to start with a really hard problem in NP.

What is the hardest problem in NP?

What does it mean to be a hard problem?

Reductions are a good definition:

If A reduces to B then " $A \leq B$ " (in terms of difficulty)

- Once you have an algorithm for B, you have one for A automatically from the reduction!

# NP-hardness

## NP-hard

The problem  $B$  is NP-hard if for all problems  $A$  in NP,  $A$  reduces to  $B$ .

An NP-hard problem is “hard enough” to design algorithms for that if you write an efficient algorithm for it, you’ve (by accident) designed an algorithm that works for every problem in NP.

What does it look like? Let  $A$  be in NP, and let  $B$  be the NP-hard problem you solved, on an input to  $A$ , “run the reduction” and plug in your actual algorithm for  $B$ !

# NP-Completeness

## NP-Complete

The problem B is NP-complete if B is in NP and B is NP-hard

An NP-complete problem is a “hardest” problem in NP.

If you have an algorithm to solve an NP-complete problem, you have an algorithm for **every** problem in NP.

An NP-complete problem is a **universal language** for encoding “I’ll know it when I see it” problems.

# Why is being NP-hard/-complete interesting?

Let  $B$  be an NP-hard problem. Suppose you found a polynomial time algorithm for  $B$ . Why is that interesting?

You now have for free a polynomial time algorithm for **every** problem in NP. (if  $A$  is in NP, then  $A \leq B$ . So plug in your algorithm for  $B$ !)

So  $P = NP$ . (if you find a polynomial time algorithm for an NP-hard problem).

On the other hand, if any problem in  $NP$  is not in  $P$  (any doesn't have a polynomial time algorithm), then no NP-complete problem is in  $P$ .

# NP-Completeness

An NP-complete problem does exist!

## Cook-Levin Theorem (1971)

3-SAT is NP-complete

Theorem 1: If a set  $S$  of strings is accepted by some nondeterministic Turing machine within polynomial time, then  $S$  is P-reducible to {DNF tautologies}.

This sentence (and the proof of it) won Cook the Turing Award.

# What's 3-SAT?

**Input:** A list of Boolean variables  $x_1, \dots, x_n$

A list of constraints, all of which must be met.

Each constraint is of the form:

$( (x_i == \langle T, F \rangle) \ || \ (x_j == \langle T, F \rangle) \ || \ (x_k == \langle T, F \rangle) )$

ORed together, always exactly three variables, you can choose T/F independently for each.

**Output:** true if there is a setting of the variables where all constraints are met, false otherwise.

Why is it called 3-SAT? 3 because you have 3 variables per constraint  
SAT is short for "satisfiability" can you satisfy all of the constraints?



# More Starting Points

We have one NP-hard problem (3-SAT). It'd be nice if we had more...

I'm just going to give us more (if you're interested in proving these NP-complete, many are [here](#))

3-coloring is NP-complete.

Hamiltonian Path (given a directed graph, is there a path that visits every vertex exactly once?) is NP-complete.

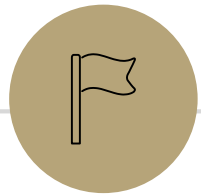

---

## More Reduction Facts

---

# I have a problem

My problem  $C$  is hard.

So hard, it's probably NP-hard. How do I show it?

What does it mean to be NP-hard?

We need to be able to reduce any problem  $A$  to  $C$ .

Let's choose  $B$  to be a **known** NP-hard problem. Since  $B$  is **known** to be NP-hard,  $A \leq B$  for every possible  $A$ . So if **we show**  $B \leq C$  too then  $A \leq B \leq C \rightarrow A \leq C$  so every NP problem reduces to  $C$ !

$$A \leq B \leq C \rightarrow A \leq C$$

Is that true?

Solver for  $A$

Because  $A \leq B$ , we have this reduction.

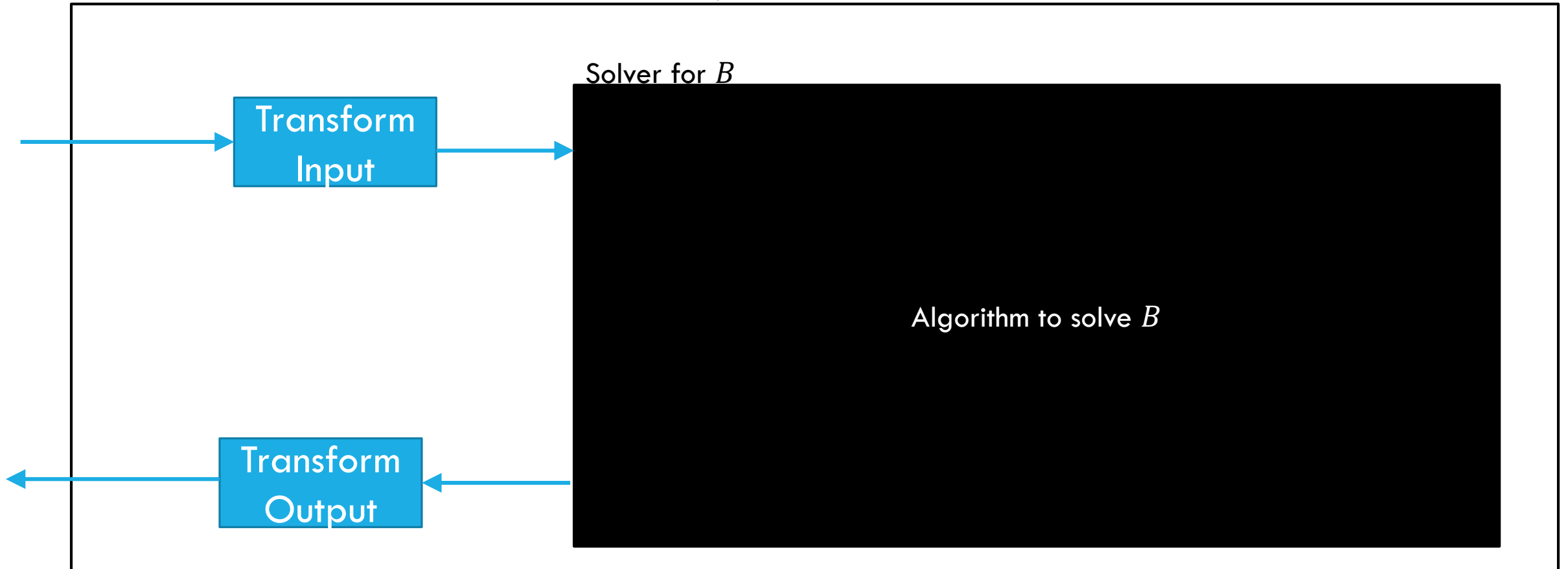

$$A \leq B \leq C \rightarrow A \leq C$$

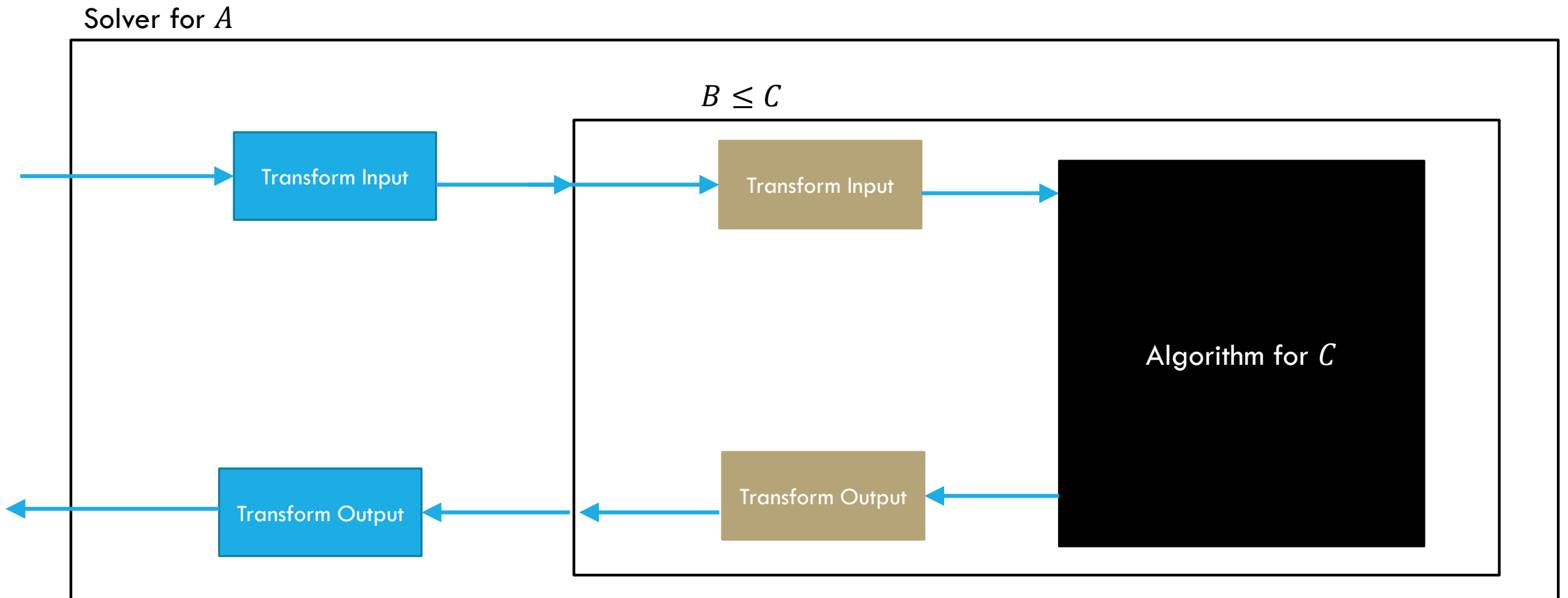

$$A \leq B \leq C \rightarrow A \leq C$$

Why does it work? Because our reductions work!

How long does it take? Still polynomial time! (Even if the input gets bigger at each step, it still can't get bigger than a polynomial). And we don't need a  $B$  solver, the reduction is the solver! We only use a  $C$  solver so it's "really" a reduction.

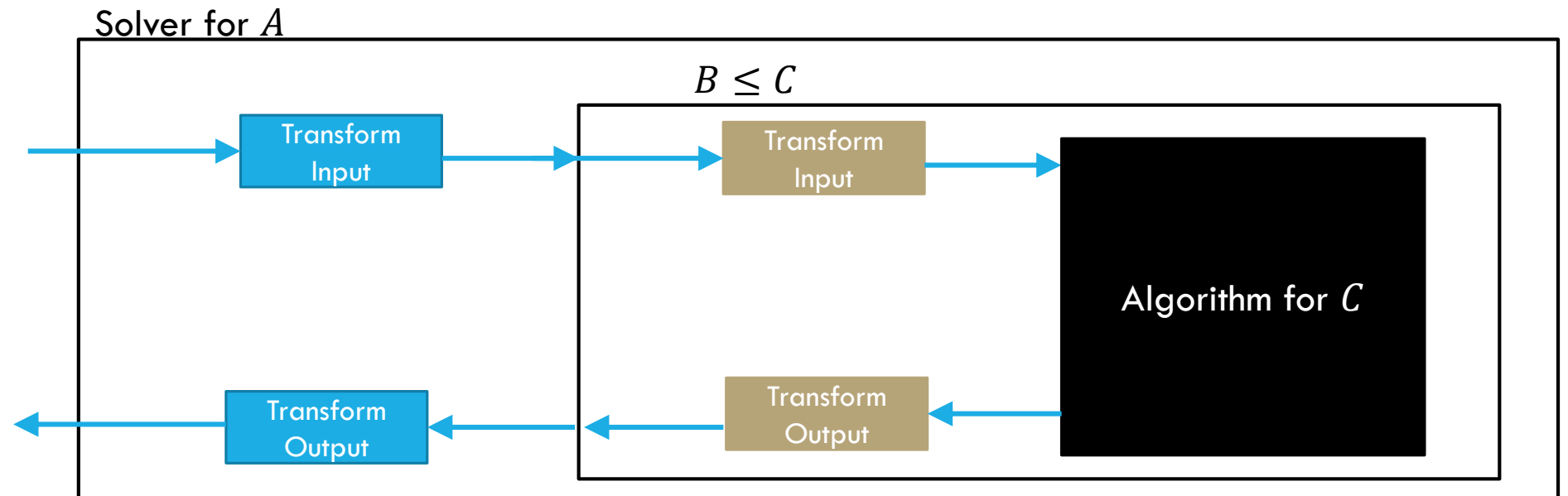

# Said Differently

$$A \leq B$$

If I know  $B$  is not hard [I have an algorithm for it] then  $A$  is also not hard.

This is how we usually use reductions

$$A \leq B$$

If I know  $A$  is hard, then  $B$  also must be hard.

(contrapositive of the last statement)

# Want to prove your problem is hard?

To show  $B$  is hard,

Reduce **FROM** the known hard problem **TO** the problem you care about  
A reduction **From** an NP-hard problem  $A$  to  $B$ , shows  $B$  is also NP-hard.