

CSE 417: Algorithms

Graphs and Graph Algorithms

Larry Ruzzo

Goals

Graphs: defns, examples, utility, terminology

Representation: input, internal

Traversal: Breadth- & Depth-first search

Five Graph Algorithms:

Connected components

Shortest Paths

Topological sort

Bipartiteness

Articulation points

} Review

} Review ?

Graphs

An extremely important formalism for representing (binary) relationships

Objects: "vertices," aka "nodes"

Relationships between pairs:

"edges," aka "arcs"

Formally, a graph $G = (V, E)$ is a pair of sets, V the vertices and E the edges

Objects & Relationships

The Kevin Bacon Game:

Obj: Actors

Rel: Two are related if they've been in a movie together

Exam Scheduling:

Obj: Classes

Rel: Two are related if they have students in common

Traveling Salesperson Problem:

Obj: Cities

Rel: Two are related if can travel *directly* between them

Undirected Graph $G = (V, E)$

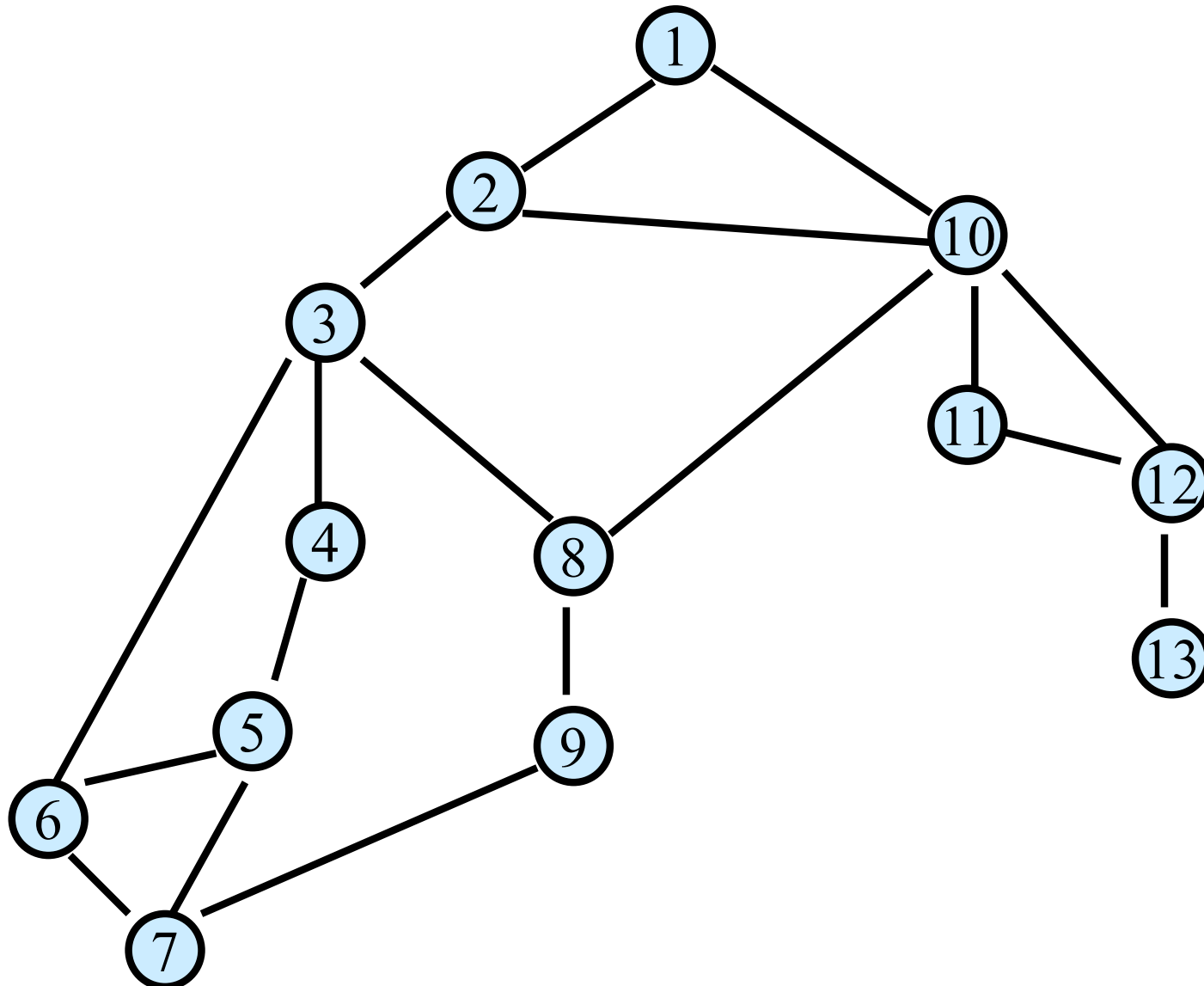

Undirected Graph $G = (V, E)$

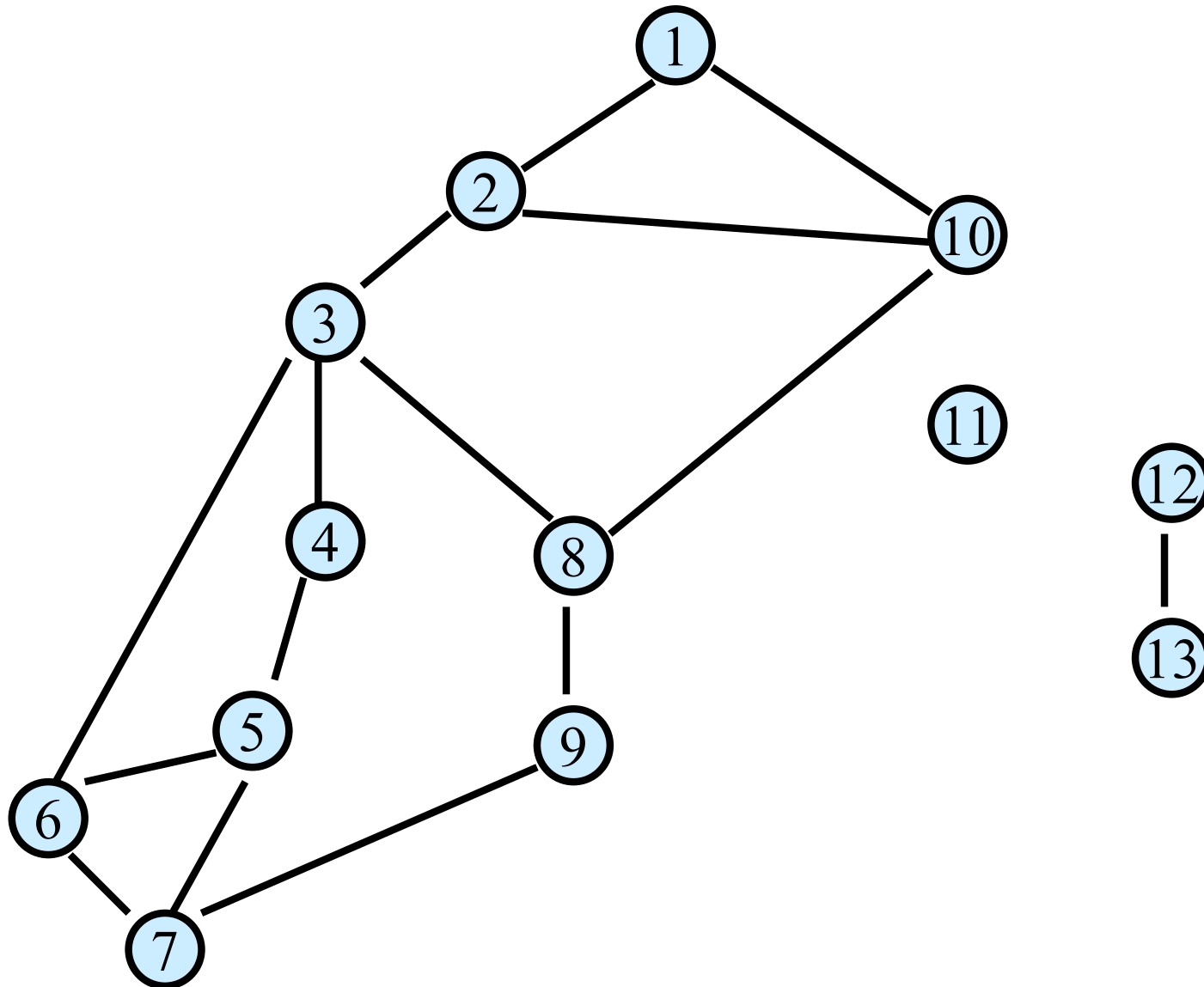

Undirected Graph $G = (V, E)$

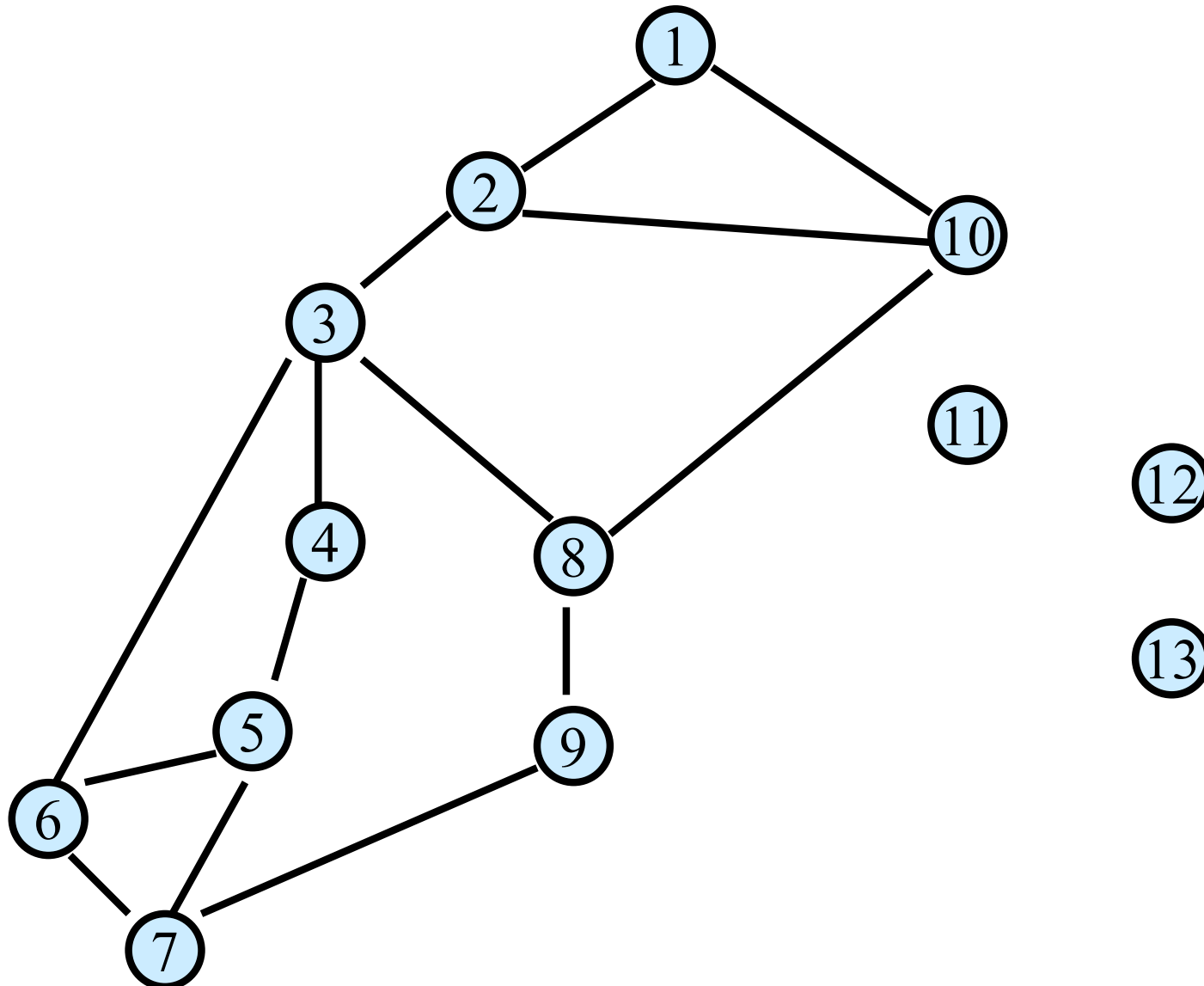

Undirected Graph $G = (V, E)$

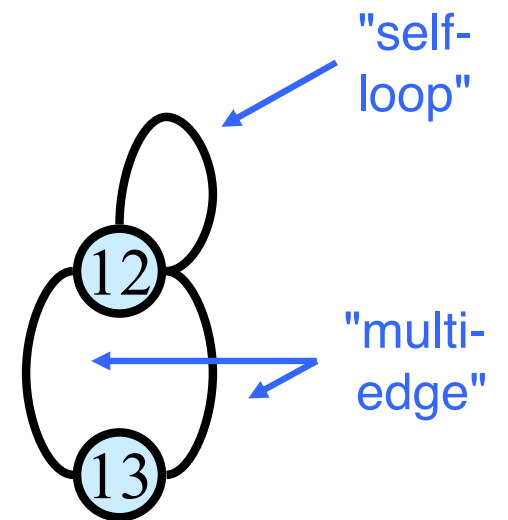
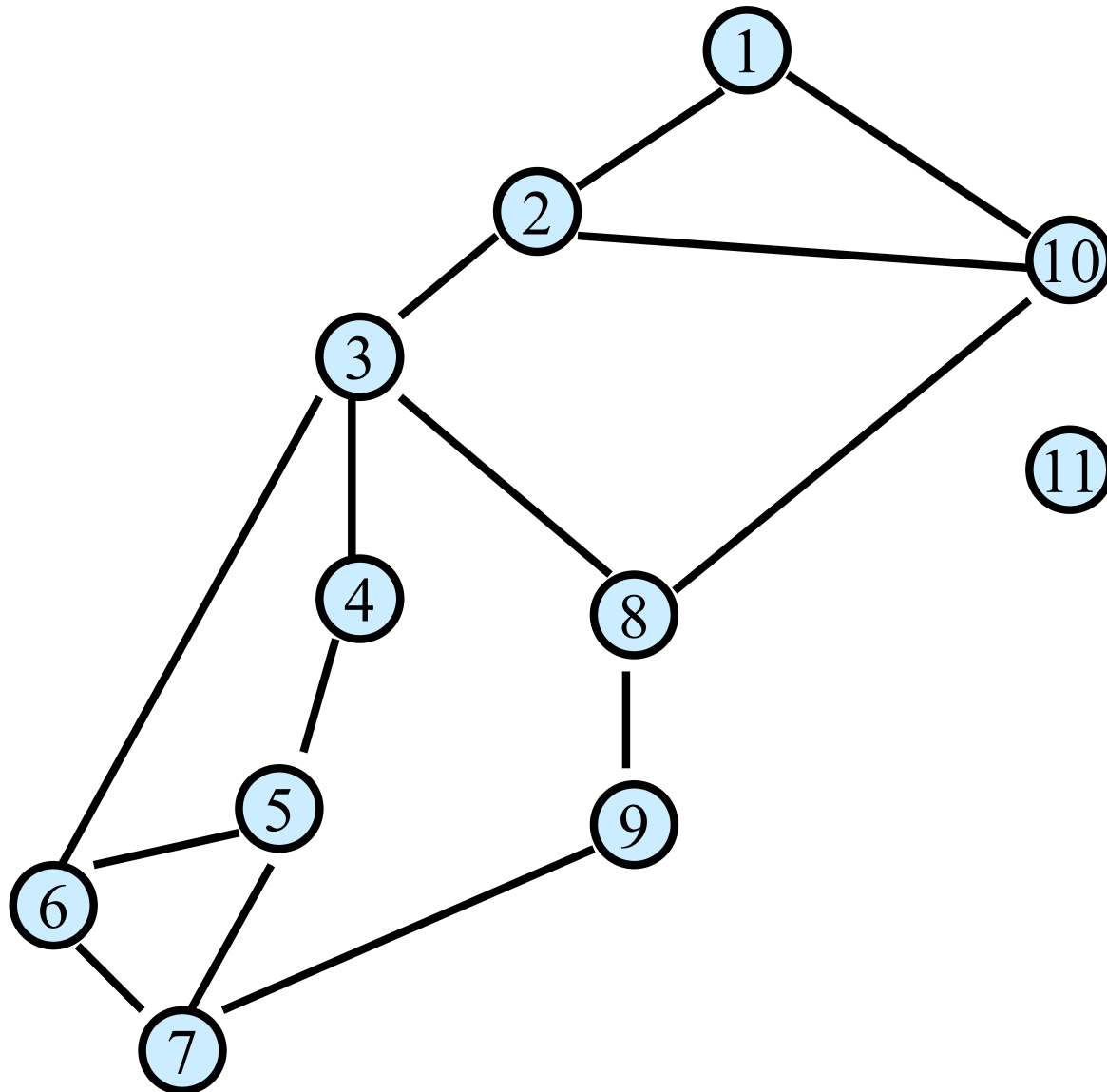

Undirected Graph $G = (V, E)$

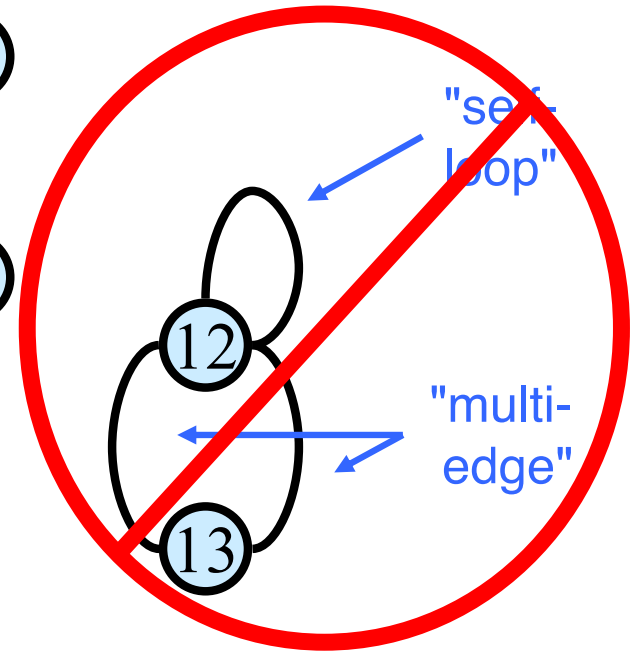
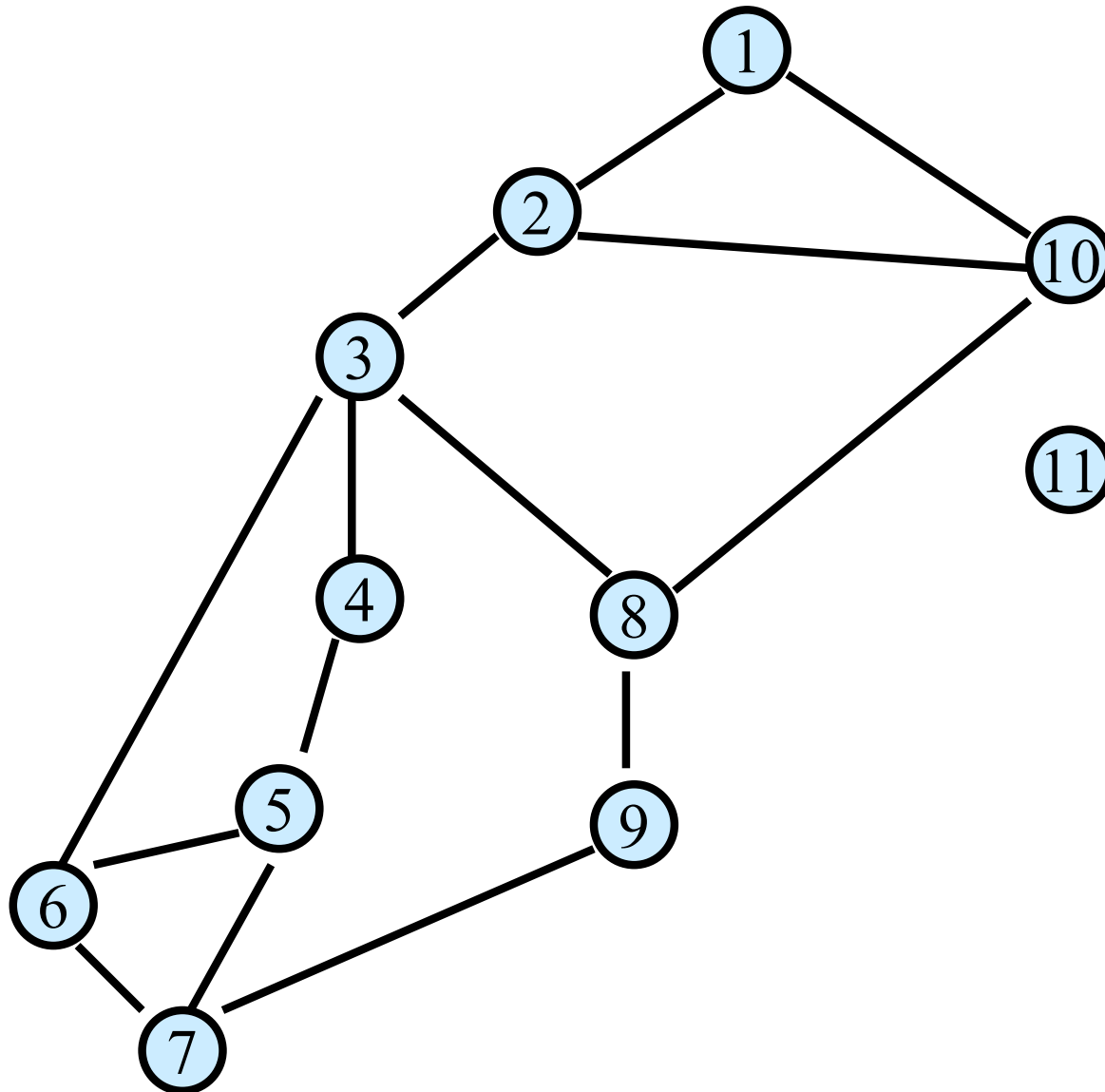

Graphs don't live in Flatland

Geometrical drawing is mentally convenient, but mathematically irrelevant: 4 drawings, 1 graph.

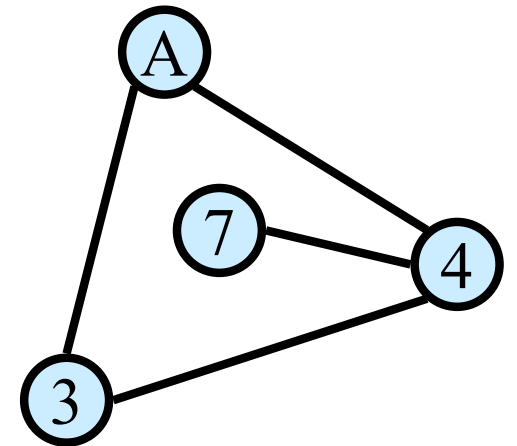
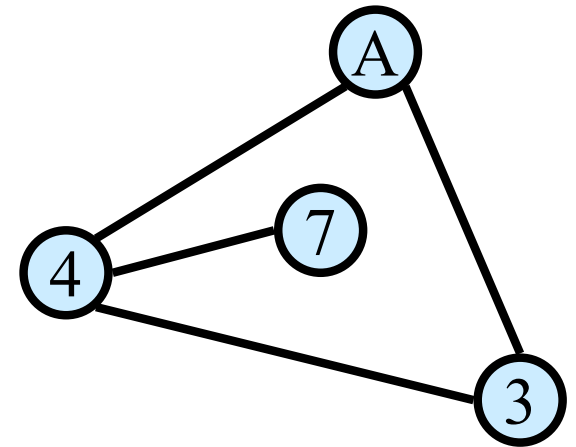
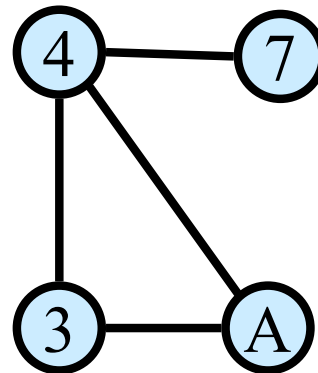
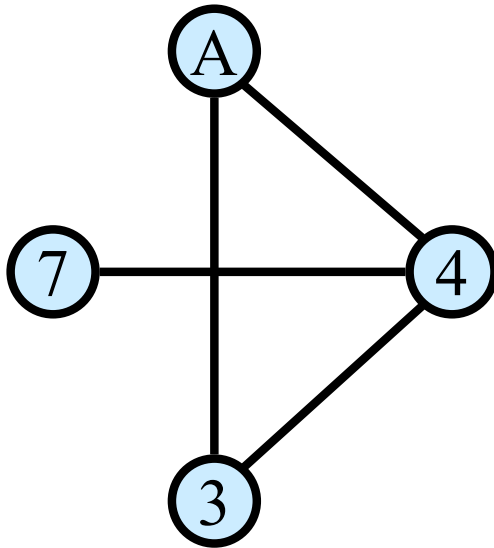

Directed Graph $G = (V, E)$

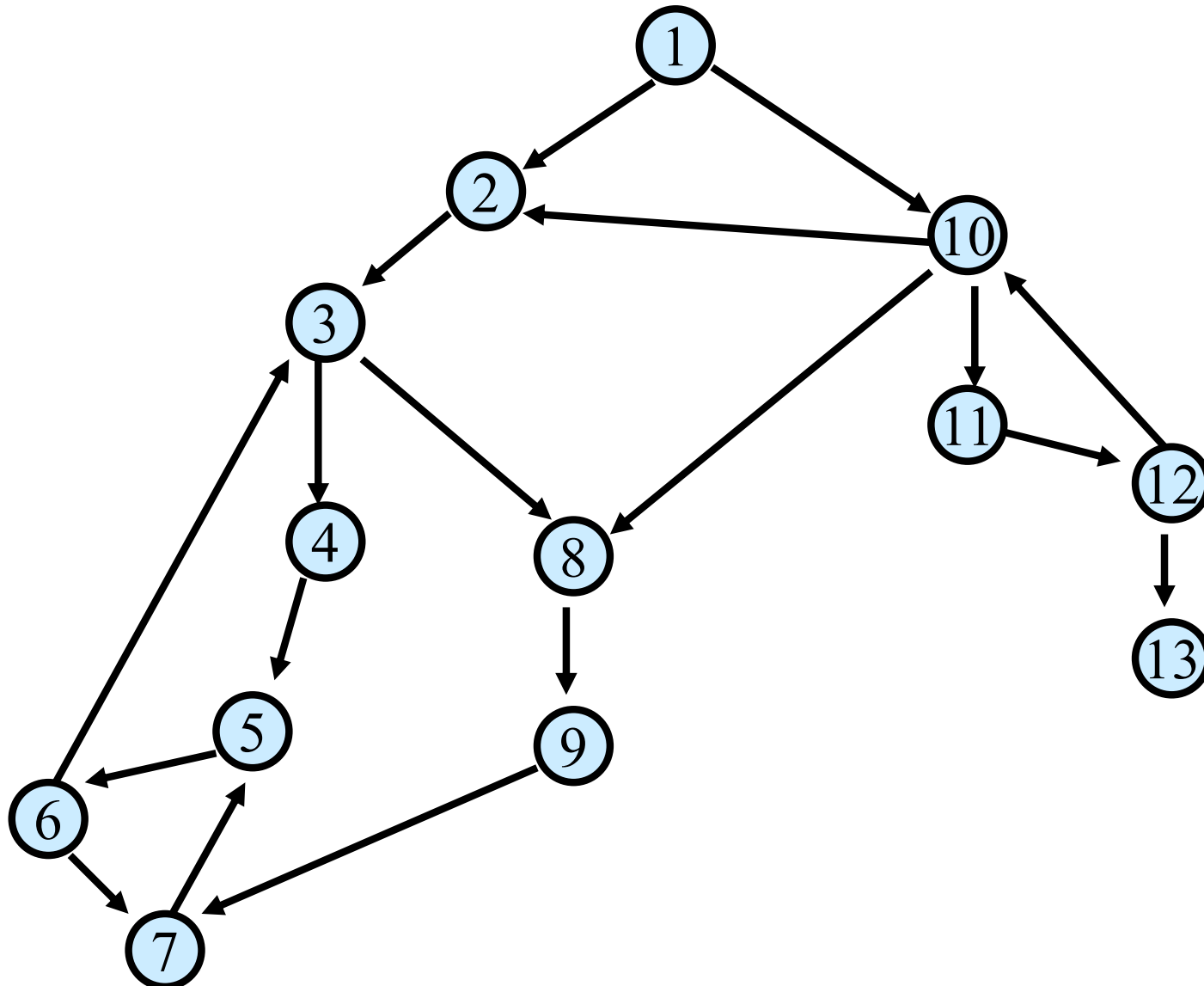

Directed Graph $G = (V, E)$

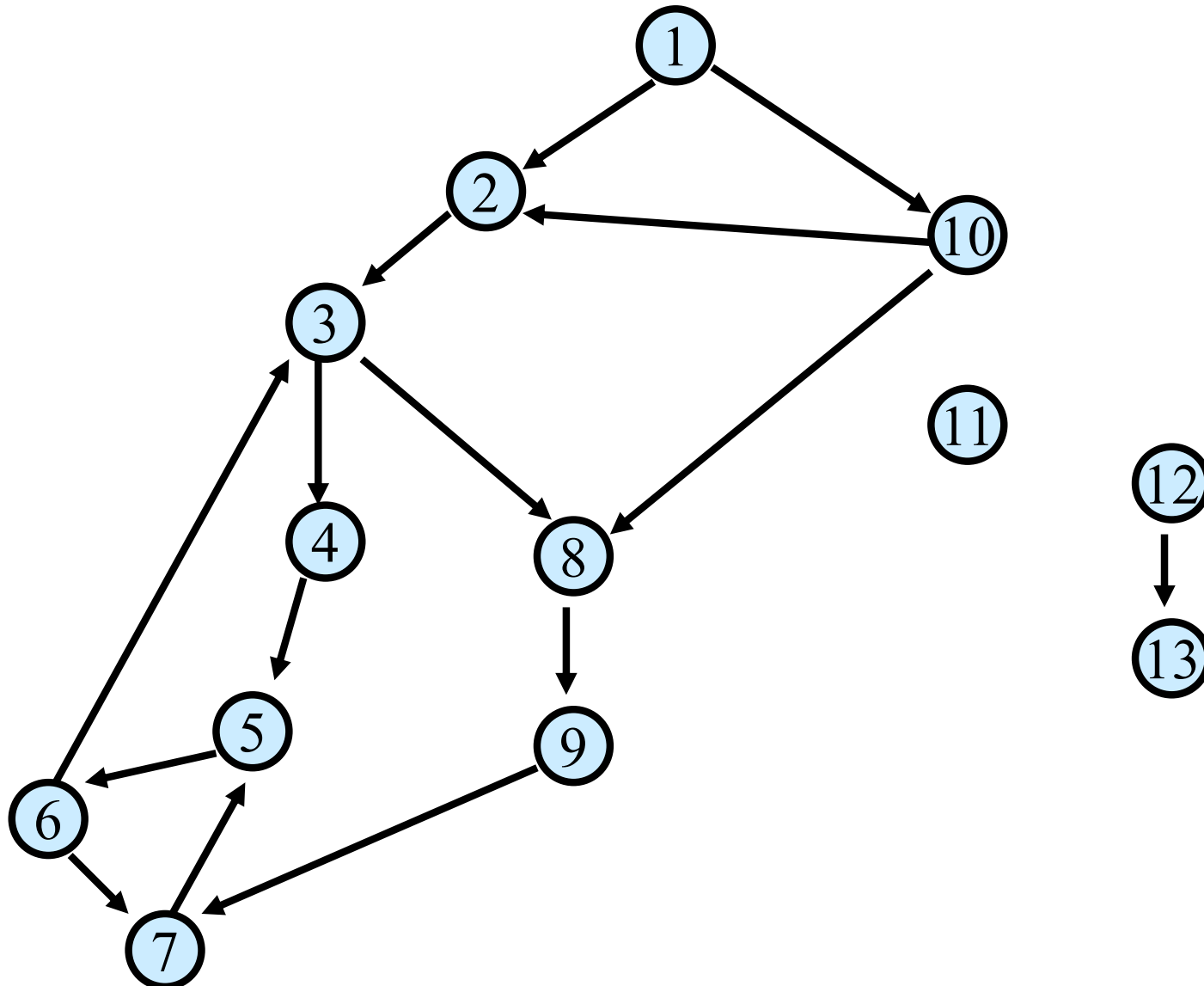

Directed Graph $G = (V, E)$

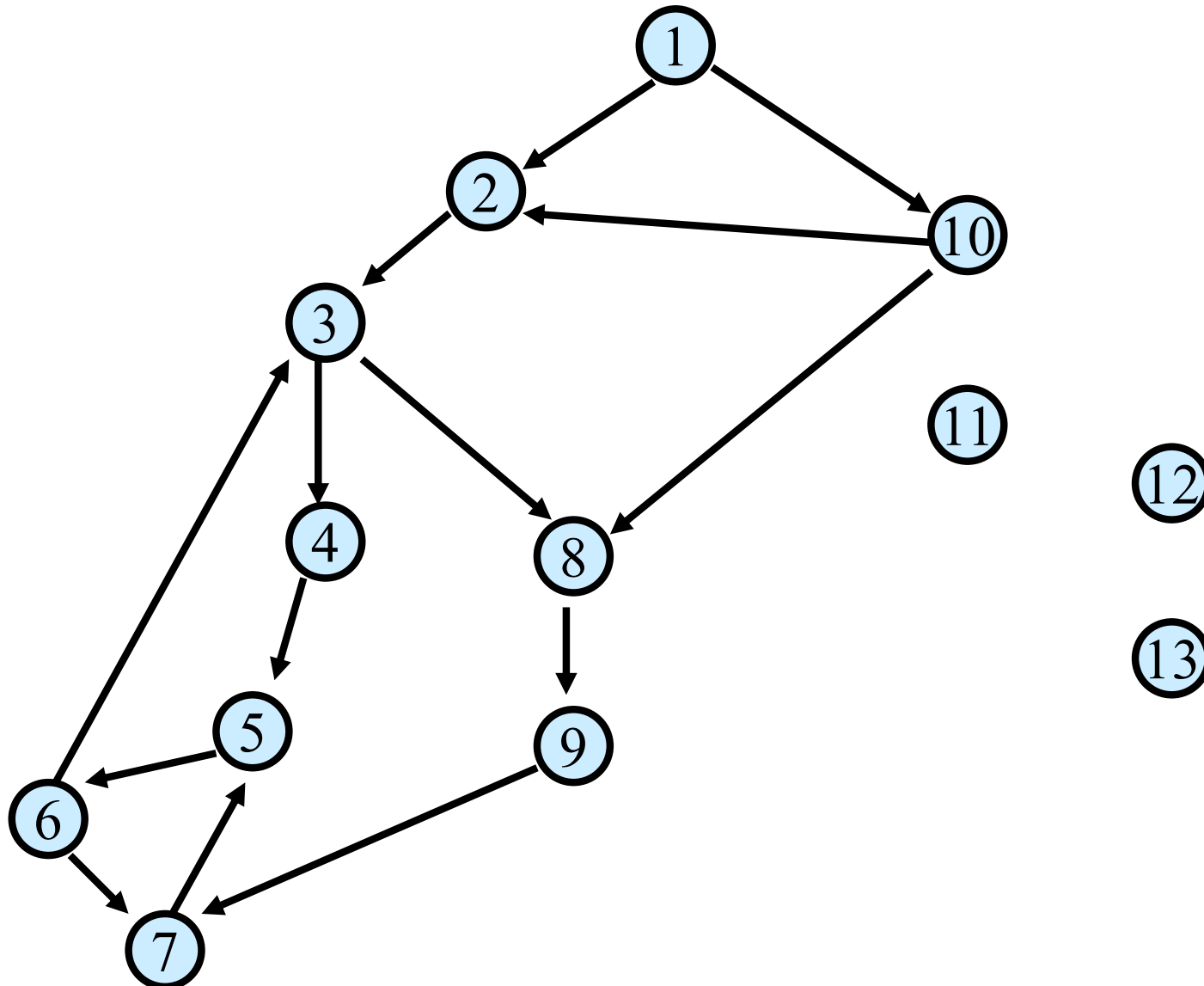

Directed Graph $G = (V, E)$

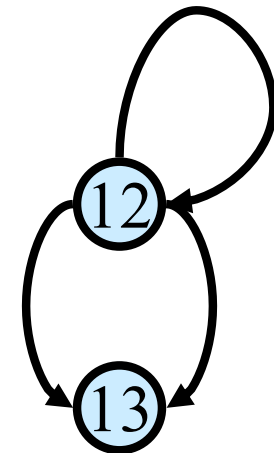
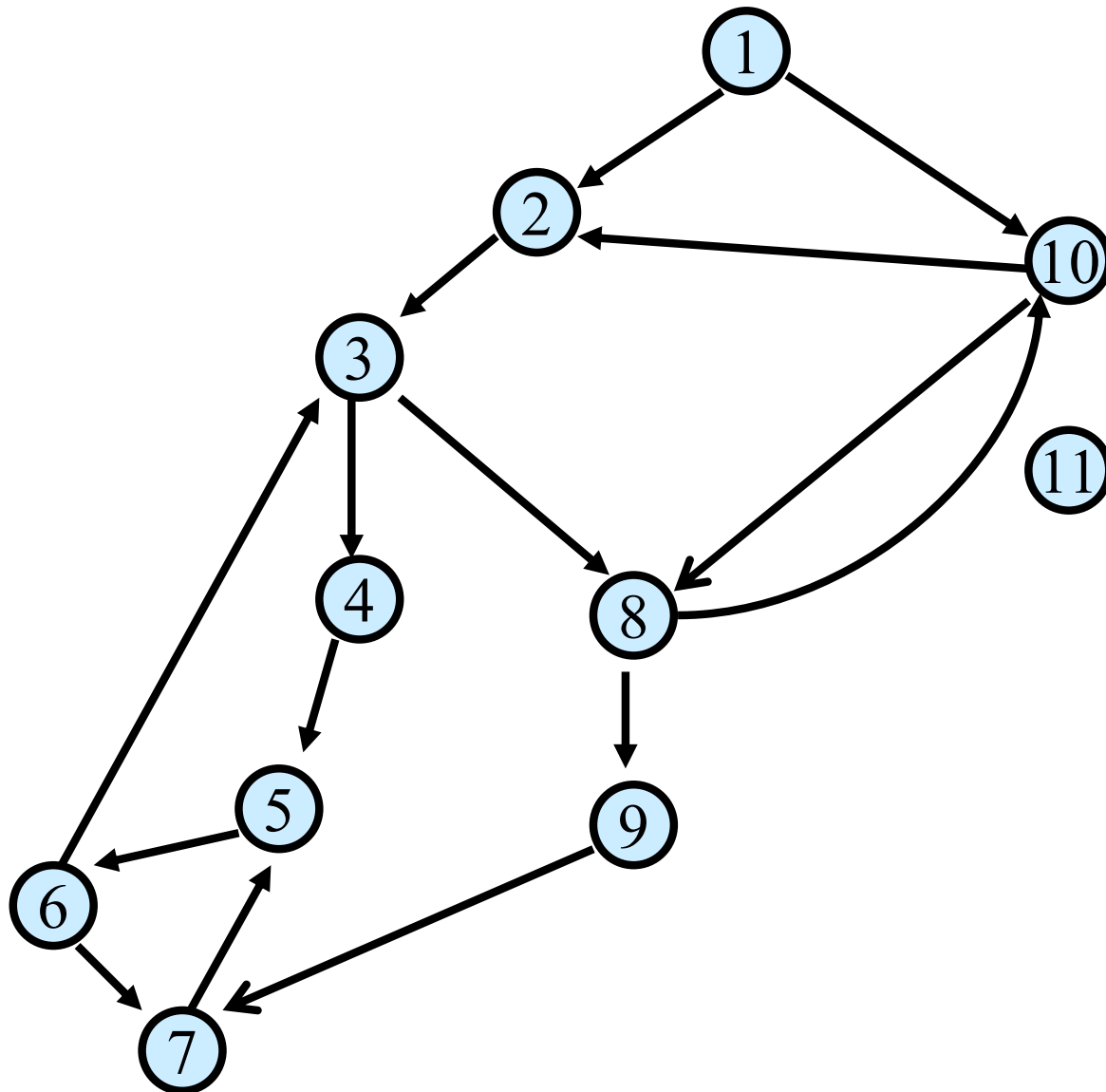

"self-loop"

"multi-edge"

Directed Graph $G = (V, E)$

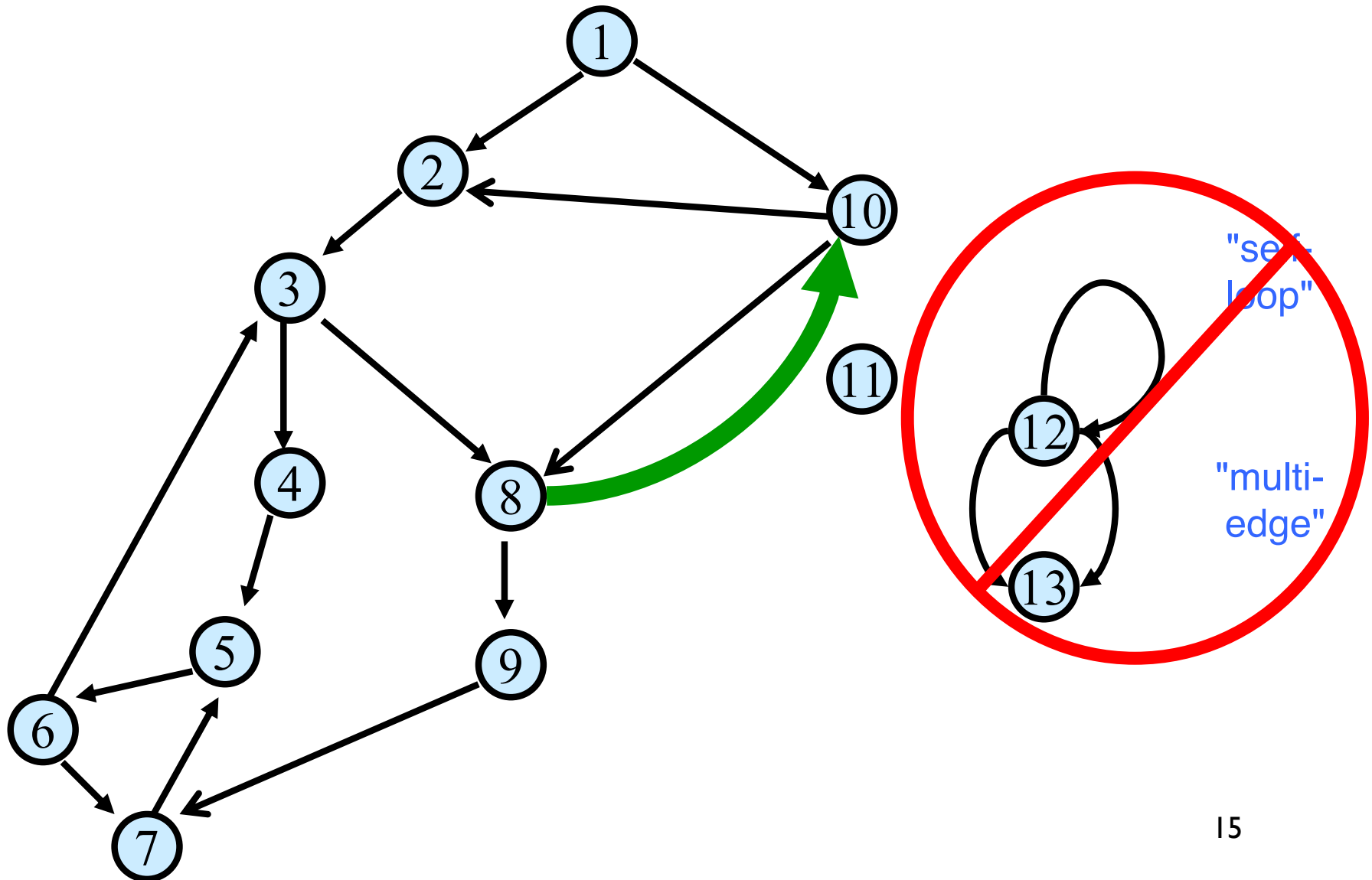

Specifying undirected graphs as input

What are the vertices?
Maybe explicitly list them:
`{"A", "7", "3", "4"}`

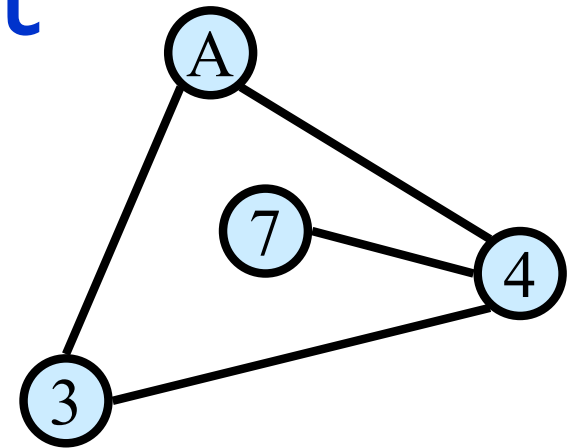

What are the edges?
Either, set of edges
`{{A,3}, {7,4}, {4,3}, {4,A}}`
Or, (symmetric) adjacency matrix:

	A	7	3	4
A	0	0	1	1
7	0	0	0	1
3	1	0	0	1
4	1	1	1	0

Specifying directed graphs as input

What are the vertices?

Maybe explicitly list them:
 $\{"A", "7", "3", "4"\}$

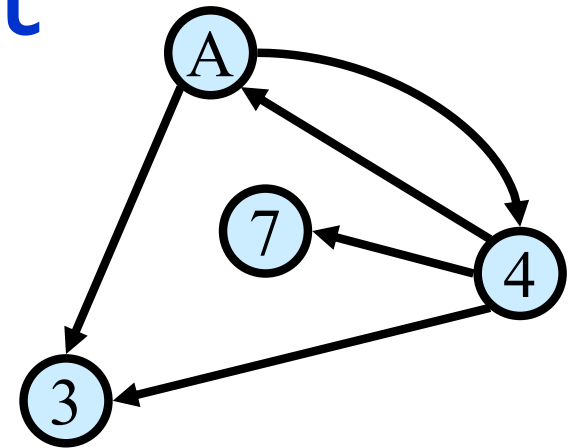

What are the edges?

Either, set of directed edges:
 $\{(A,4), (4,7), (4,3), (4,A), (A,3)\}$

Or, (nonsymmetric)
adjacency matrix:

	A	7	3	4
A	0	0	1	1
7	0	0	0	0
3	0	0	0	0
4	1	1	1	0

Vertices vs # Edges

Let G be an undirected graph with n vertices and m edges. How are n and m related?

Since

every edge connects two different vertices (no loops),
and no two edges connect the same two vertices (no
multi-edges),

it must be true that:

$$0 \leq m \leq n(n-1)/2 = O(n^2)$$

More Cool Graph Lingo

A graph is called *sparse* if $m \ll n^2$, otherwise it is *dense*

Boundary is somewhat fuzzy; $O(n)$ edges is certainly sparse, $\Omega(n^2)$ edges is dense.

Sparse graphs are common in practice

E.g., all planar graphs are sparse ($m \leq 3n-6$, for $n \geq 3$)

Q: which is a better run time, $O(n+m)$ or $O(n^2)$?

A: $O(n+m) = O(n^2)$, but $n+m$ usually way better!

Representing Graph $G = (V, E)$

internally, indep of input format

Vertex set $V = \{v_1, \dots, v_n\}$

Adjacency Matrix A

$$A[i,j] = 1 \text{ iff } (v_i, v_j) \in E$$

Space is n^2 bits

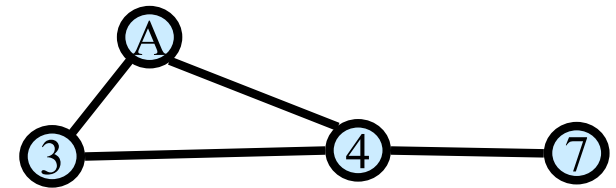

	A	7	3	4
A	0	0	1	1
7	0	0	0	1
3	1	0	0	1
4	1	1	1	0

Advantages:

$O(1)$ test for presence or absence of edges.

Disadvantages: inefficient for sparse graphs, both in storage and access

$$m \ll n^2$$

Representing Graph $G=(V,E)$

n vertices, m edges

Adjacency List:

$O(n+m)$ words

Advantages:

Compact for
sparse graphs

Easily see all edges

Disadvantages

More complex data structure

no $O(1)$ edge test

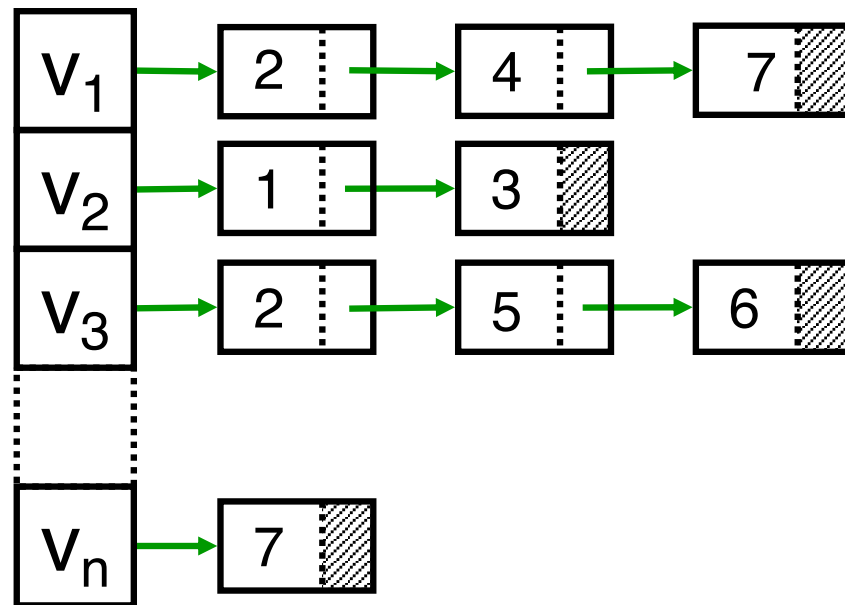

Representing Graph $G=(V,E)$

n vertices, m edges

Adjacency List:

$O(n+m)$ words

Back- and cross pointers allow easier traversal and deletion of edges, *if needed*, but don't bother if not:

- more work to build,
- more storage overhead ($\sim 3m$ pointers)

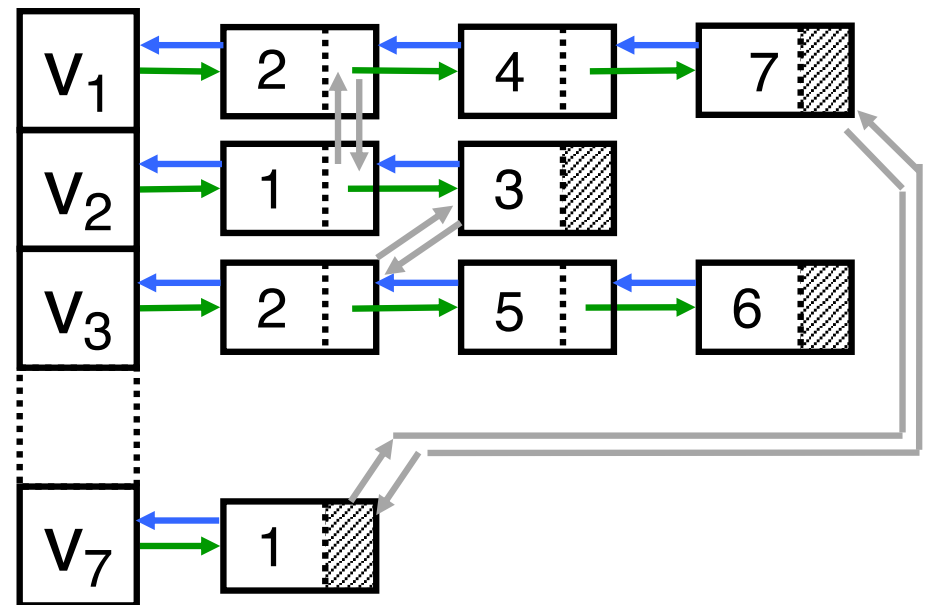

Graph Traversal

Learn the basic structure of a graph

"Walk," via edges, from a fixed starting vertex s to all vertices reachable from s

Being *orderly* helps. Two common ways:

Breadth-First Search

Depth-First Search

Breadth-First Search

Completely explore the vertices in order of their distance from s

Naturally implemented using a queue

Breadth-First Search

Idea: Explore from s in all possible directions, layer by layer.

BFS algorithm.

$L_0 = \{ s \}$.

$L_1 =$ all neighbors of L_0 .

$L_2 =$ all nodes not in L_0 or L_1 , and having an edge to a node in L_1 .

$L_{i+1} =$ all nodes not in earlier layers, and having an edge to a node in L_i .

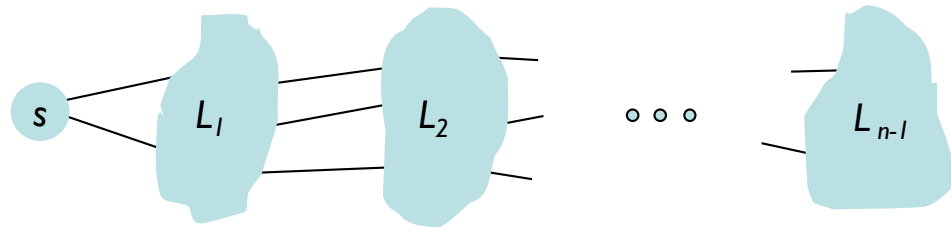

Theorem. For each i , L_i consists of all nodes at distance (i.e., min path length) exactly i from s .

Cor: There is a path from s to t iff t appears in some layer.

Graph Traversal: Implementation

Learn the basic structure of a graph

"Walk," via edges, from a fixed starting vertex s to all vertices reachable from s

Three states of vertices

undiscovered

discovered

fully-explored

BFS(s) Implementation

Global initialization: mark all vertices "undiscovered"

BFS(s)

mark s "discovered"

queue = { s }

while queue not empty

 u = remove_first(queue)

 for each edge {u,x}

 if (x is undiscovered)

 mark x discovered

 append x on queue

 mark u fully explored

Exercise: modify
code to number
vertices & compute
level numbers

BFS(v)

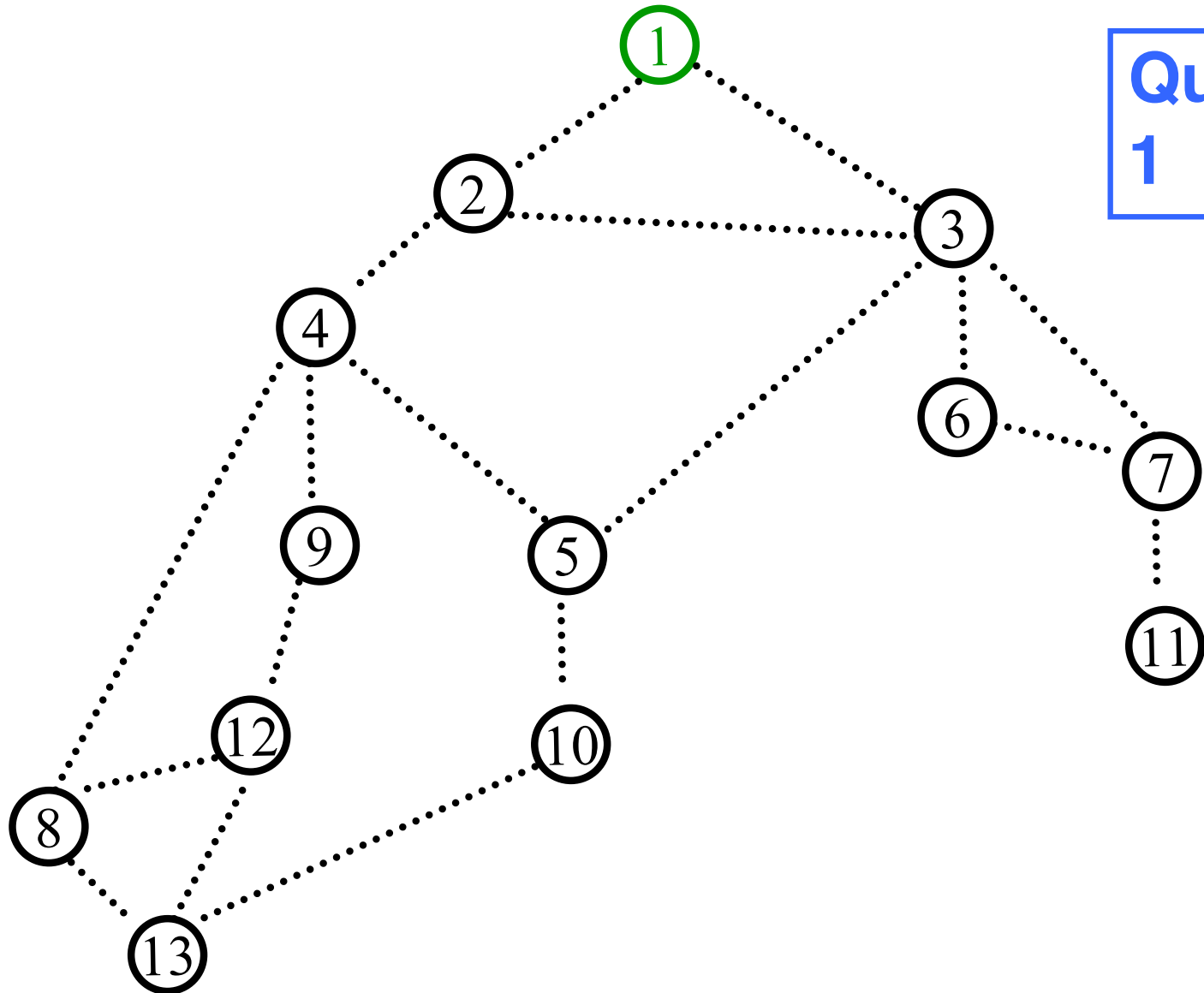

BFS(v)

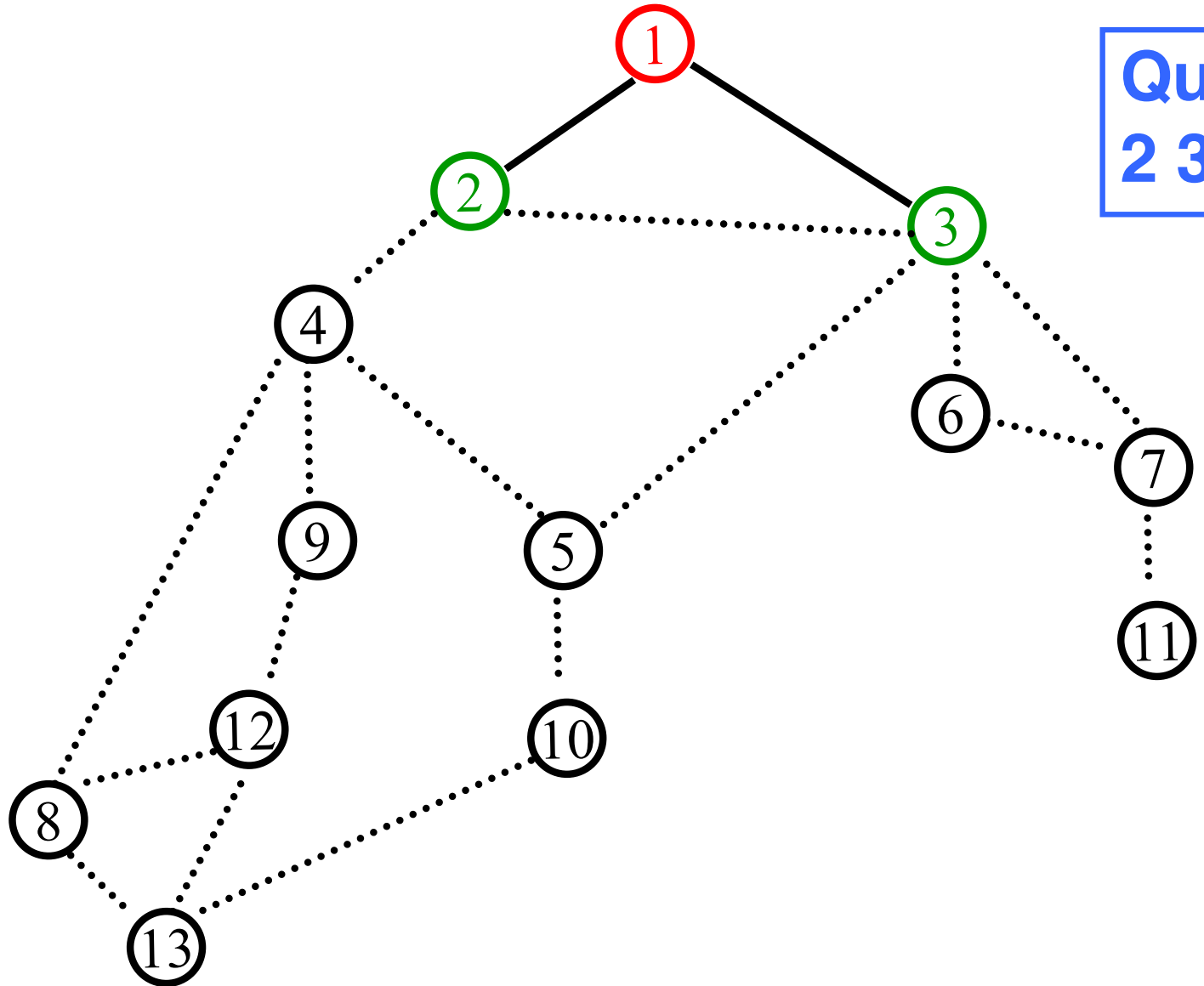

BFS(v)

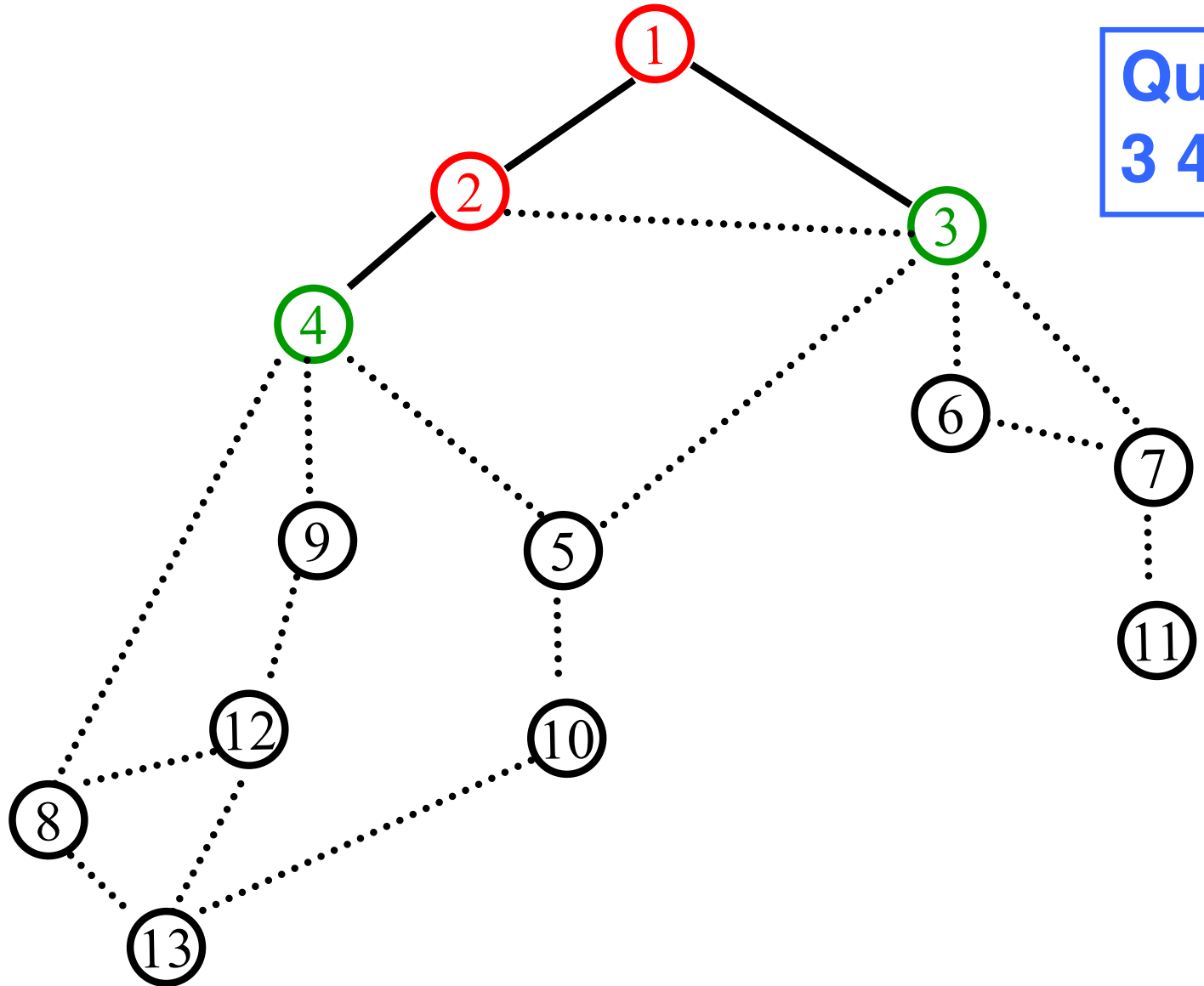

Queue:
3 4

BFS(v)

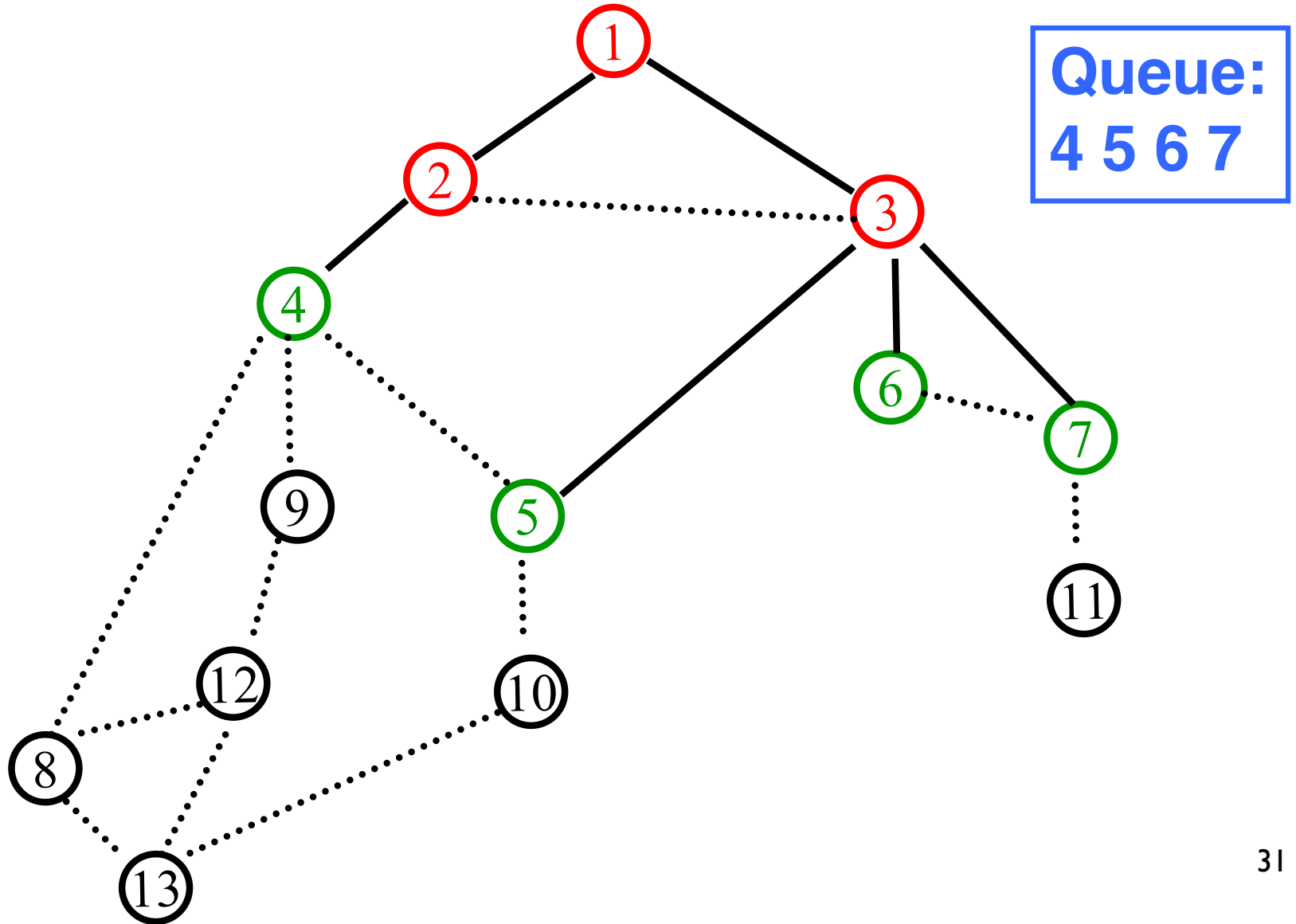

BFS(v)

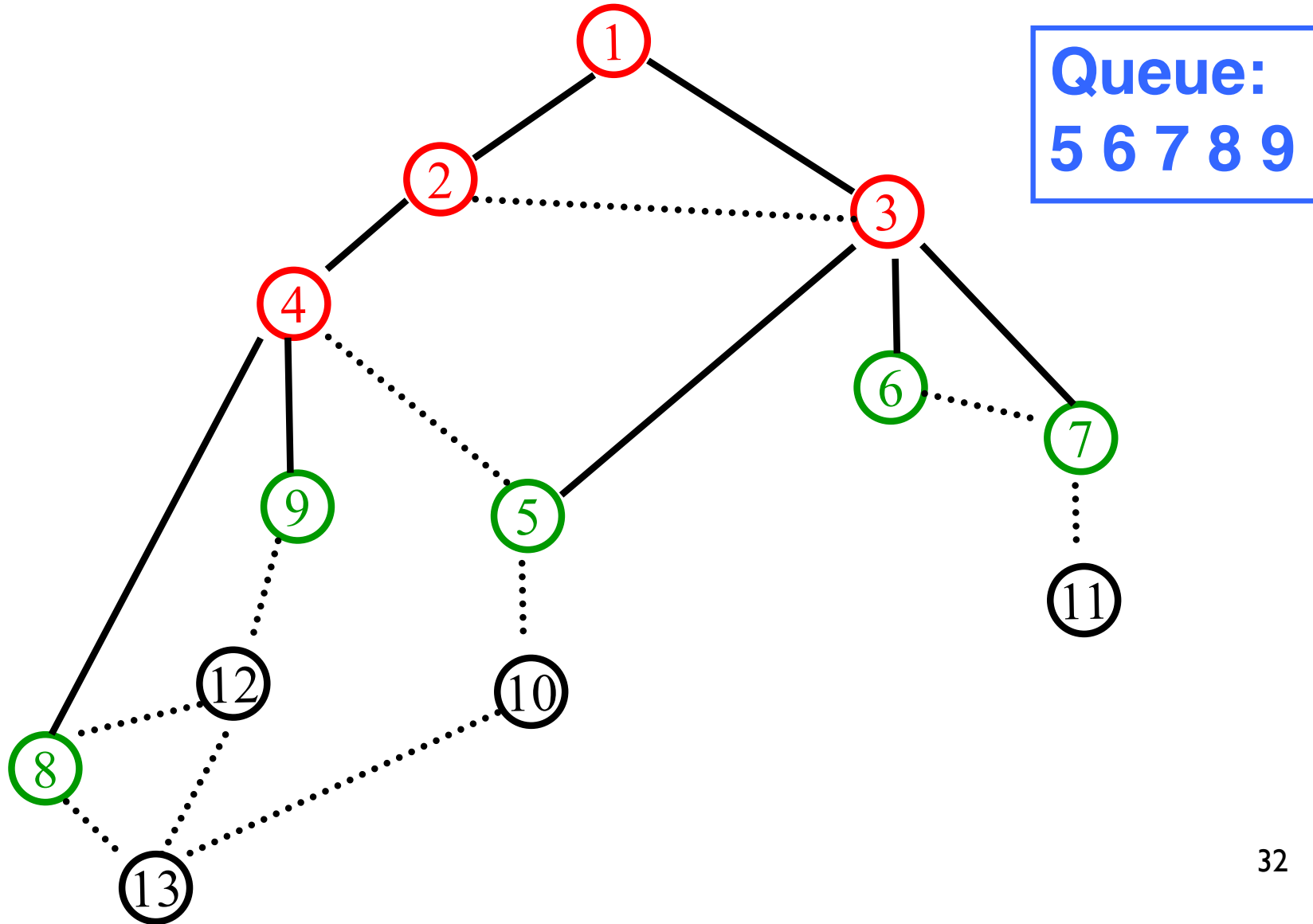

BFS(v)

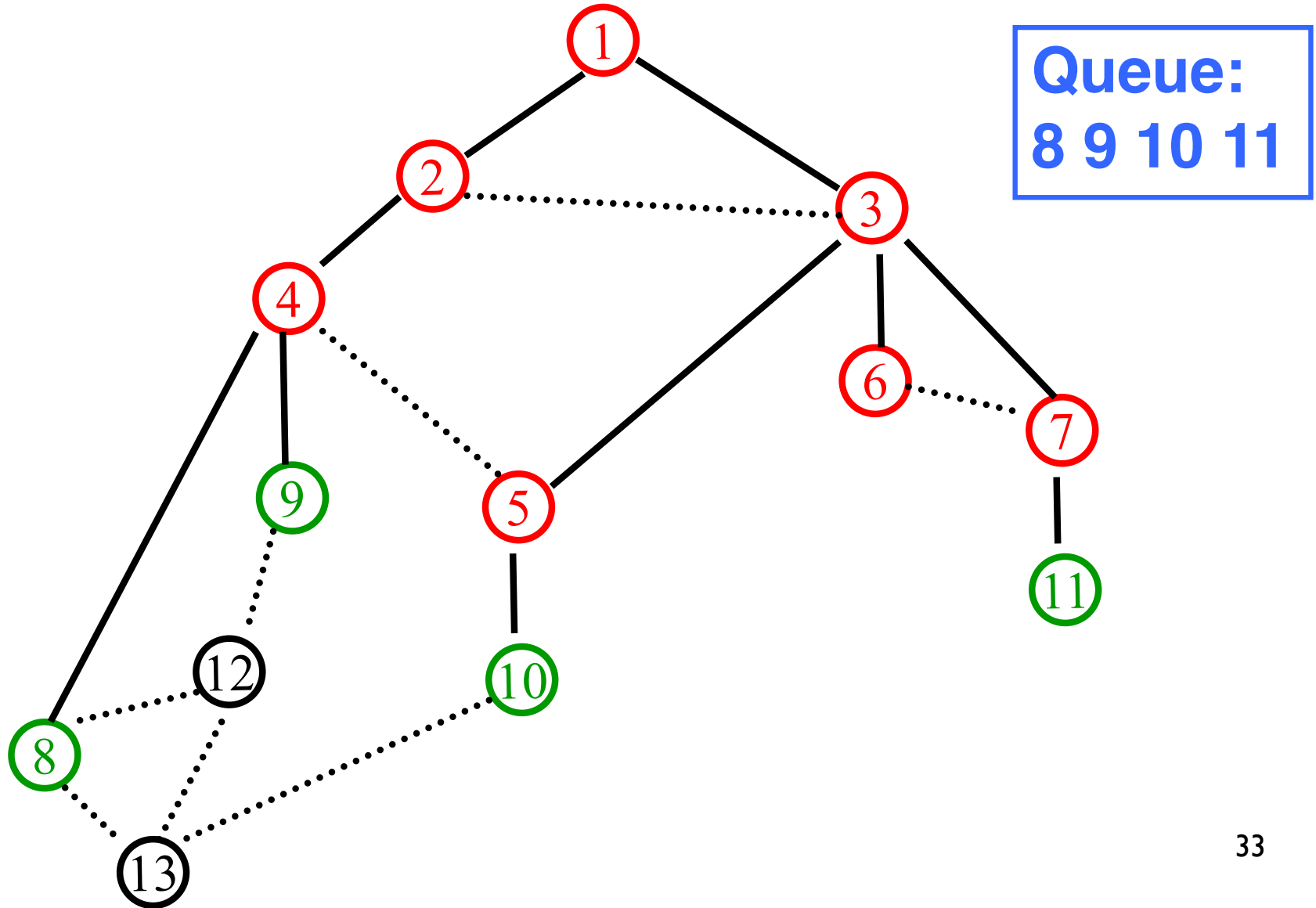

BFS(v)

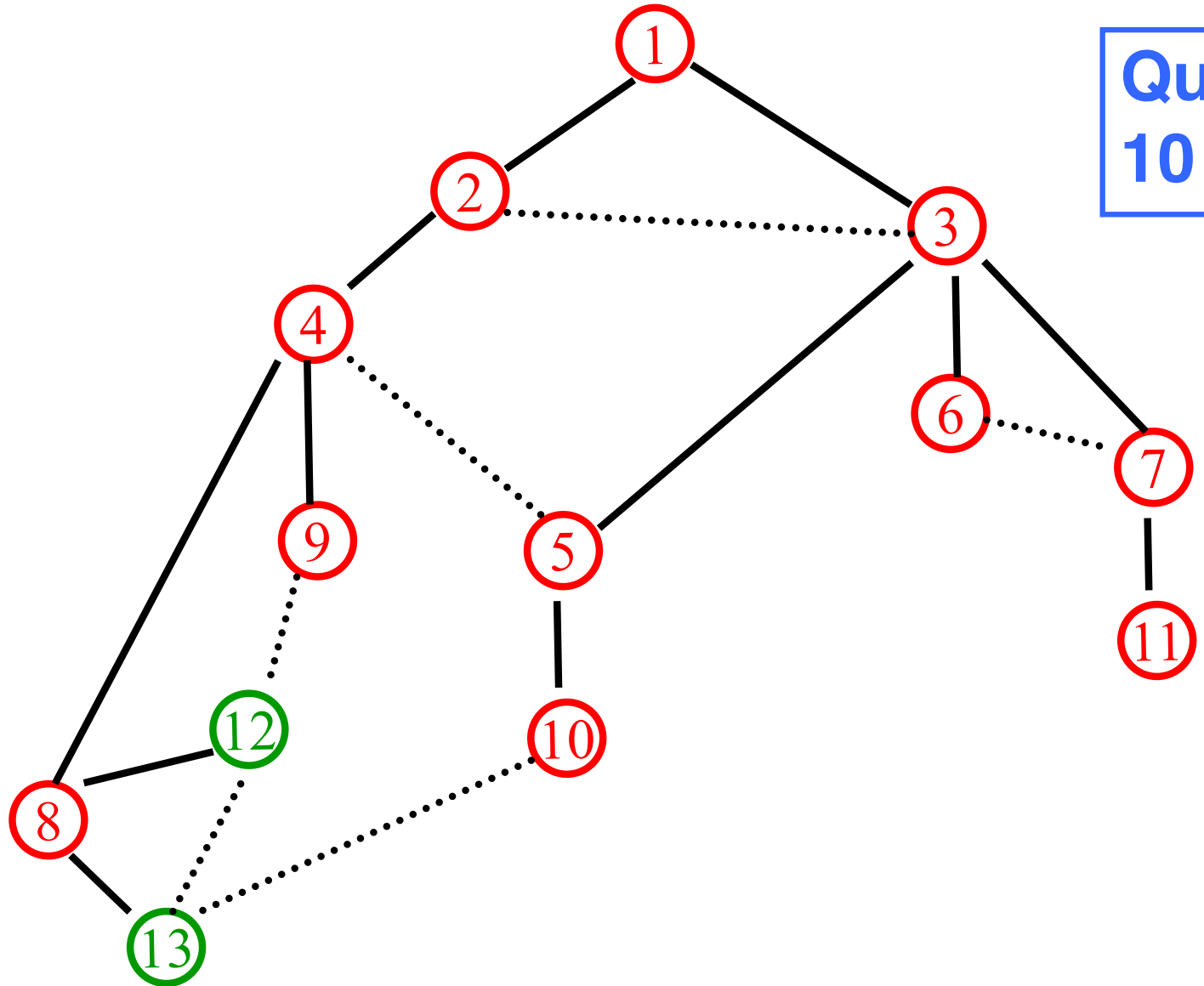

Queue:
10 11 12 13

BFS: Analysis, I

$O(n)$ Global initialization: mark all vertices "undiscovered"
+ BFS(s)

$O(1)$ mark s "discovered"

+ queue = { s }

$O(n)$ while queue not empty

x u = remove_first(queue)

$O(n)$ for each edge {u,x}

if (x is undiscovered)

mark x discovered

append x on queue

mark u fully explored

=

$O(n^2)$

Simple analysis:
2 nested loops.
Get worst-case
number of
iterations of each;
multiply.

BFS: Analysis, II

Above analysis *correct*, but *pessimistic*, assuming G is sparse, edge list representation: can't have $\Omega(n)$ edges incident to each of $\Omega(n)$ distinct "u" vertices.

Alt, more global analysis:

Each edge is explored once from each end-point, so *total* runtime of inner loop is $O(m)$, (assuming edge-lists)

Exercise: extend algorithm and analysis to non-connected graph

Total $O(n+m)$, $n = \#$ nodes, $m = \#$ edges

Properties of (Undirected) BFS(v)

BFS(v) visits x if and only if there is a path in G from v to x .

Edges into then-undiscovered vertices define a **tree** – the "breadth first spanning tree" of G

Level i in this tree are exactly those vertices u such that the shortest path (in G , not just the tree) from the root v is of length i .

All non-tree edges join vertices on the same or adjacent levels

not true
of every
spanning
tree!

BFS Application: Shortest Paths

Tree (solid edges)
gives shortest
paths from
start vertex

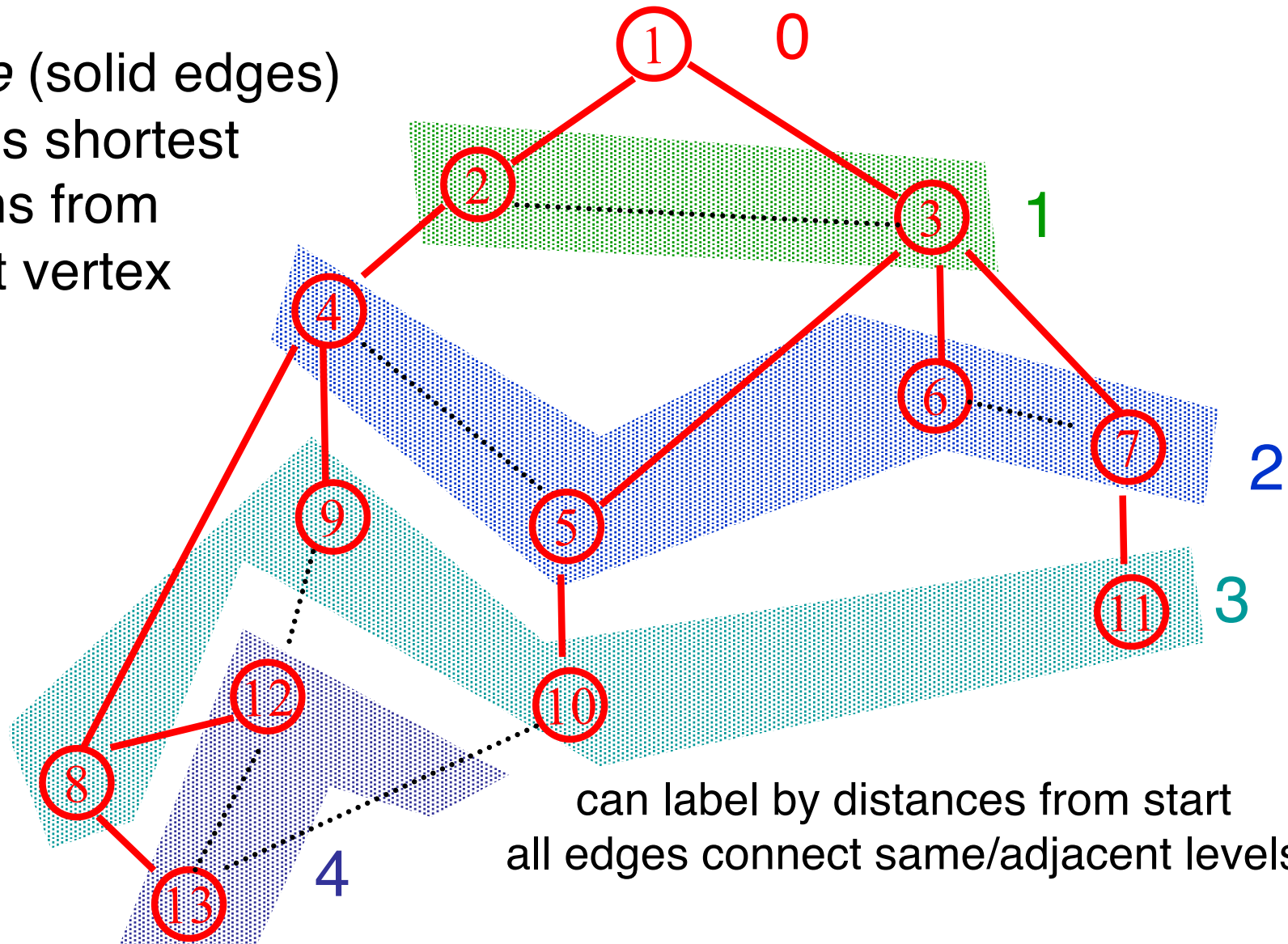

BFS Application: Shortest Paths

Tree (solid edges)
gives shortest
paths from
start vertex

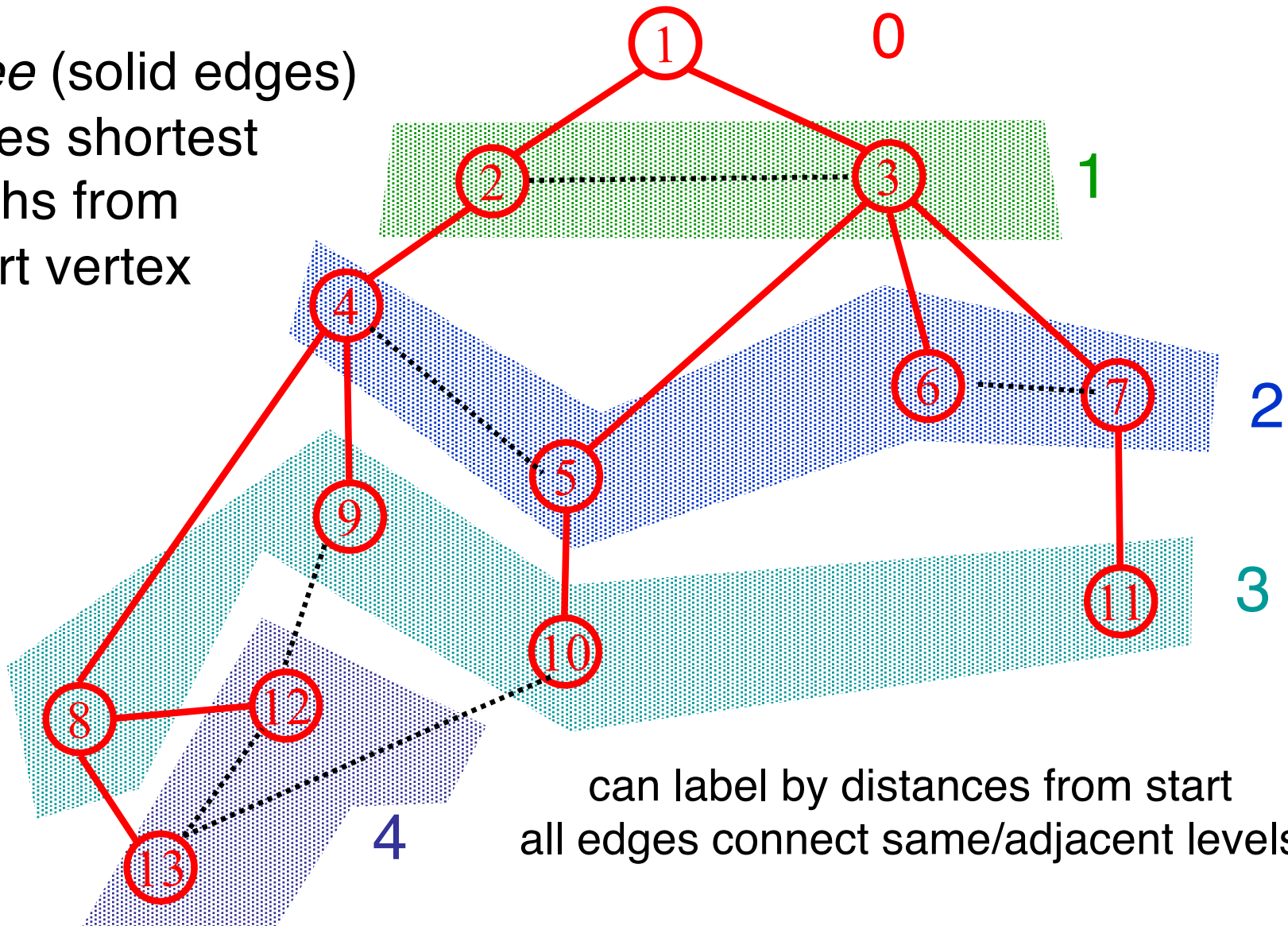

BFS Application: Shortest Paths

Tree (solid edges)
gives shortest
paths from
start vertex

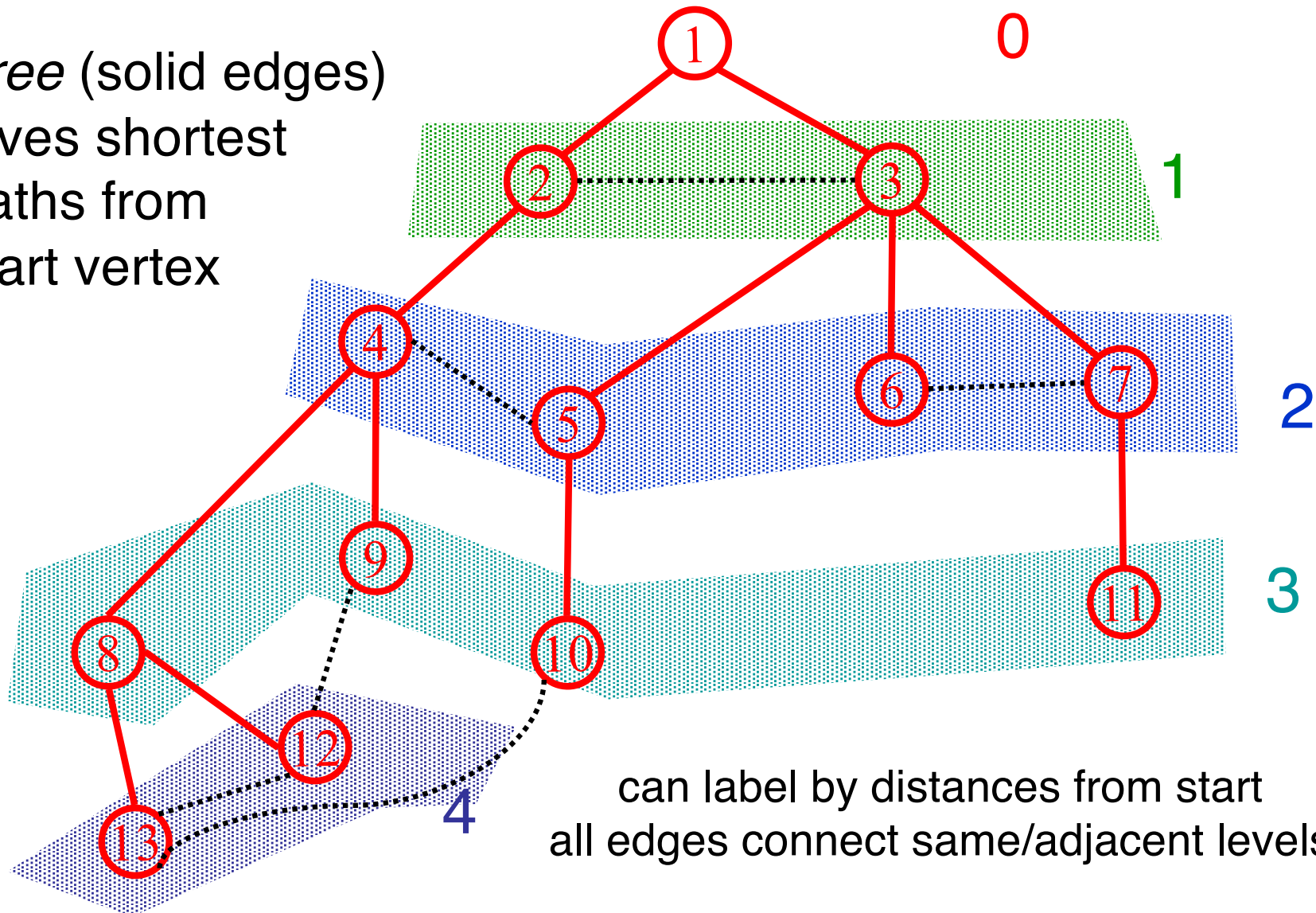

BFS Application: Shortest Paths

Tree (solid edges)
gives shortest
paths from
start vertex

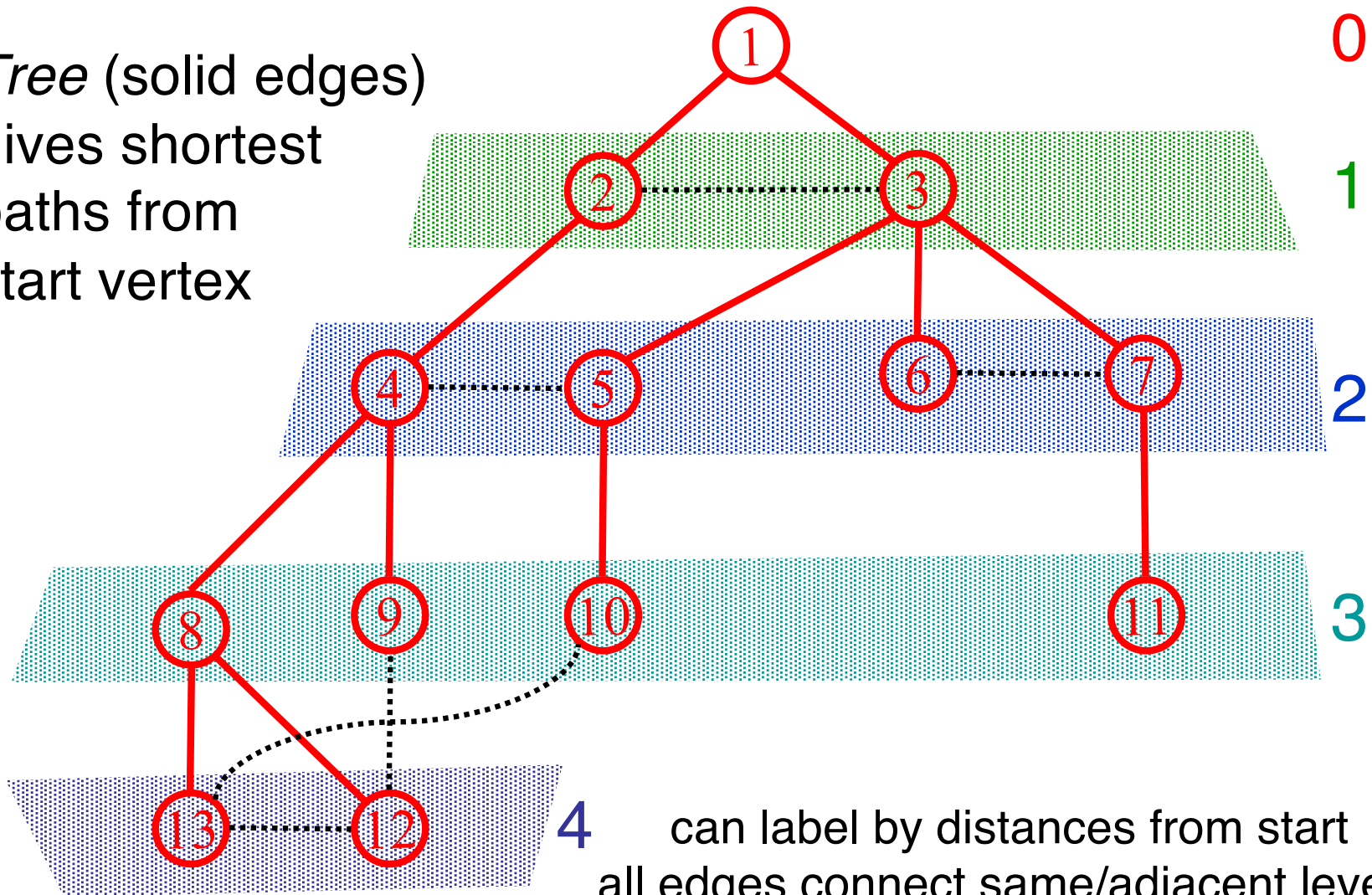

can label by distances from start
all edges connect same/adjacent levels₄₂

Why fuss about trees?

Trees are simpler than graphs

Ditto for algorithms on trees vs algs on graphs

So, this is often a good way to approach a graph problem: find a "nice" tree in the graph, i.e., one such that non-tree edges have some simplifying structure

E.g., BFS finds a tree s.t. level-jumps are minimized

DFS (below) finds a different tree, but it also has interesting structure...

Graph Search Application: Connected Components

Want to answer questions of the form:

Given vertices u and v , is there a path from u to v ?

Idea: create array A such that

$A[u]$ = smallest numbered vertex that is connected to u . Question reduces to whether $A[u]=A[v]$?

Q: Why not use 2-d array $Path[u,v]$?

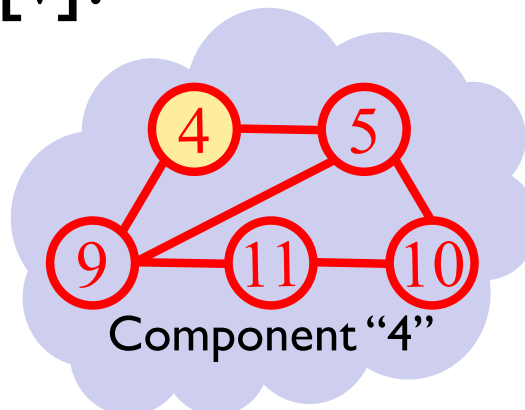
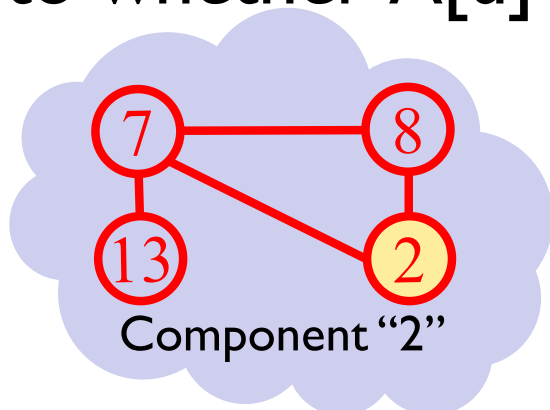

$A[8] = A[13]$? Y
 $A[8] = A[9]$? N

Graph Search Application: Connected Components

```
initial state: all v undiscovered
for v = 1 to n do
  if state(v) != fully-explored then
    BFS(v): setting A[u] ← v for each u found
             (and marking u discovered/fully-explored)
  endif
endfor
```

Total cost: $O(n+m)$ Naively, *three* nested loops $\Rightarrow O(n^3)$, but careful look at BFS(v) shows $O(n_i+m_i)$ if v's component has n_i nodes & m_i edges; $\sum n_i+m_i = n+m$. Idea: each edge is touched twice, once from each end. (True for DFS, too)

3.4 Testing Bipartiteness

Bipartite Graphs

Def. An undirected graph $G = (V, E)$ is *bipartite (2-colorable)* if the nodes can be colored red or blue such that no edge has both ends the same color.

Applications.

Stable marriage: men = red, women = blue

Scheduling: machines = red, jobs = blue

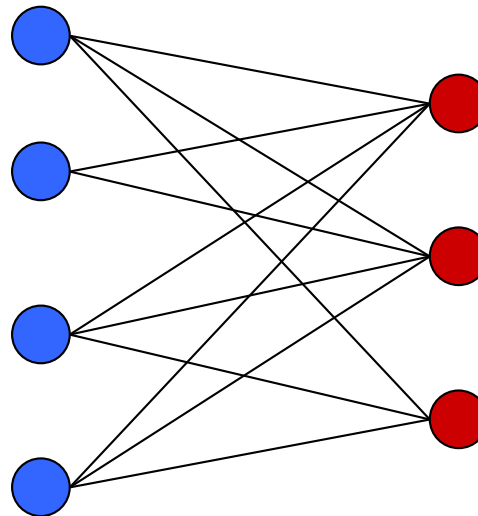

a bipartite graph

"bi-partite" means "two parts." An equivalent definition: G is bipartite if you can partition the node set into 2 parts (say, blue/red or left/right) so that all edges join nodes in different parts/no edge has both ends in the same part.

Testing Bipartiteness

Testing bipartiteness. Given a graph G , is it bipartite?

Many graph problems become:

easier if the underlying graph is bipartite (matching)

tractable if the underlying graph is bipartite (independent set)

Before attempting to design an algorithm, we need to understand structure of bipartite graphs.

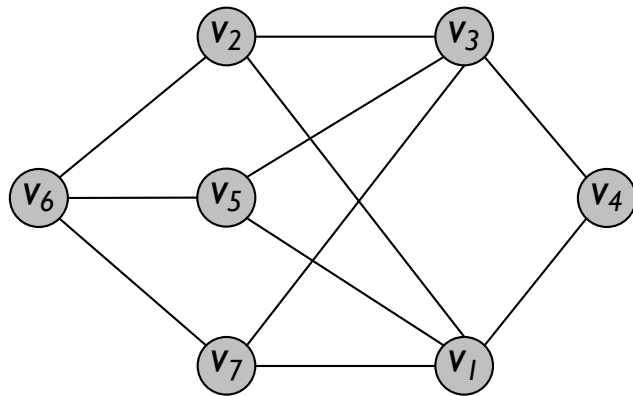

a bipartite graph G

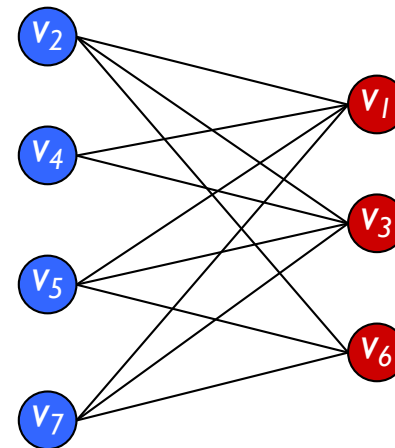

another drawing of G

An Obstruction to Bipartiteness

Lemma. If a graph G is bipartite, it cannot contain an odd length cycle.

Pf. Impossible to 2-color the odd cycle, let alone G .

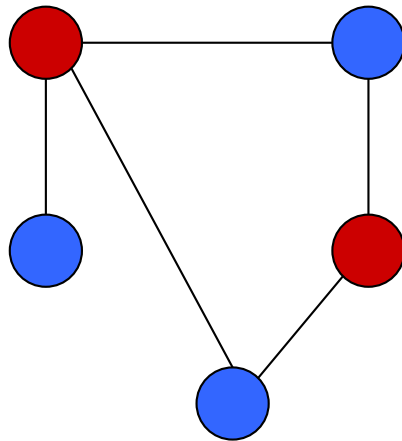

*bipartite
(2-colorable)*

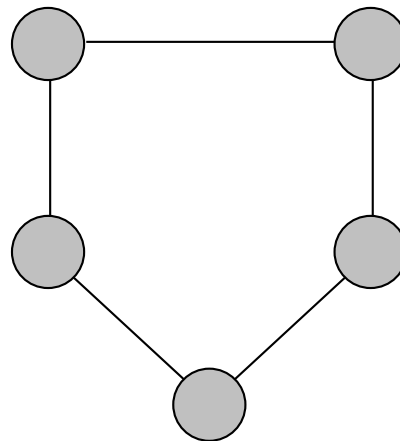

*not bipartite
(not 2-colorable)*

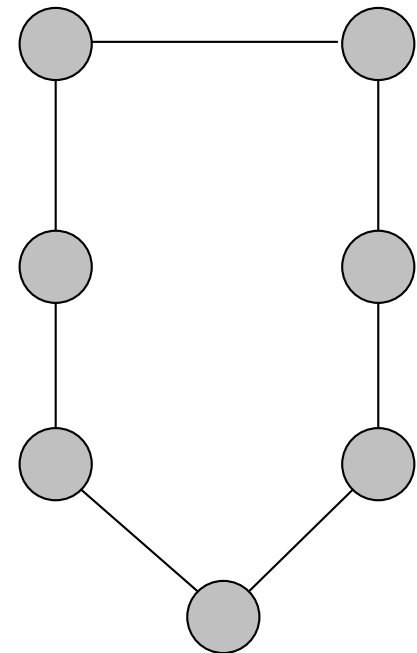

*not bipartite
(not 2-colorable)*

Bipartite Graphs

Lemma. Let G be a connected graph, and let L_0, \dots, L_k be the layers produced by BFS starting at node s . Exactly one of the following holds.

- (i) No edge of G joins two nodes of the same layer, and G is bipartite.
- (ii) An edge of G joins two nodes of the same layer, and G contains an odd-length cycle (and hence is not bipartite).

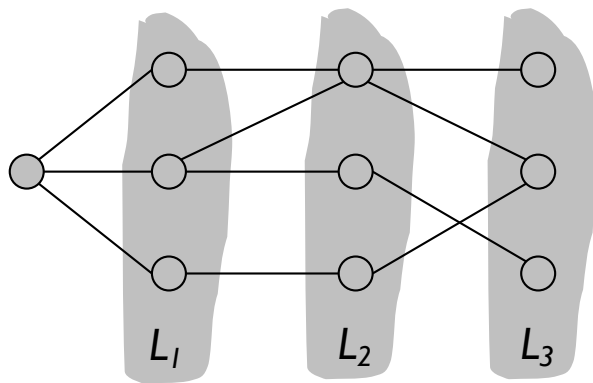

Case (i)

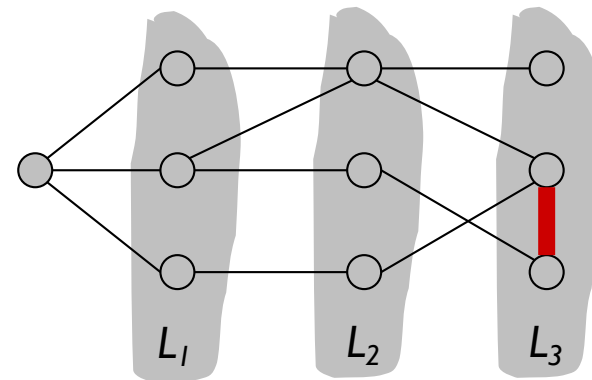

Case (ii)

Bipartite Graphs

Lemma. Let G be a connected graph, and let L_0, \dots, L_k be the layers produced by BFS starting at node s . Exactly one of the following holds.

- (i) No edge of G joins two nodes of the same layer, and G is bipartite.
- (ii) An edge of G joins two nodes of the same layer, and G contains an odd-length cycle (and hence is not bipartite).

Pf. (i)

Suppose no edge joins two nodes in the same layer.
By previous lemma, all edges join nodes on adjacent levels.

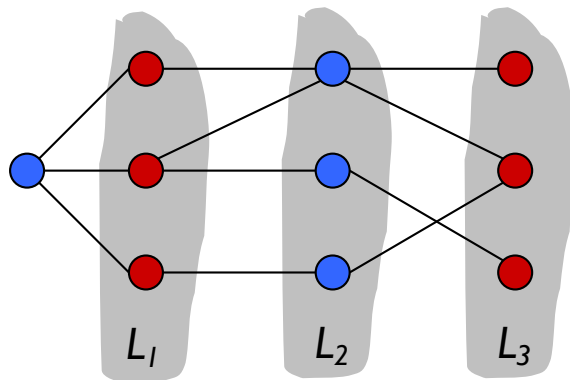

Case (i)

Bipartition:

red = nodes on odd levels,
blue = nodes on even levels.

Bipartite Graphs

Lemma. Let G be a connected graph, and let L_0, \dots, L_k be the layers produced by BFS starting at node s . Exactly one of the following holds.

- (i) No edge of G joins two nodes of the same layer, and G is bipartite.
- (ii) An edge of G joins two nodes of the same layer, and G contains an odd-length cycle (and hence is not bipartite).

Pf. (ii)

Suppose (x, y) is an edge & x, y in same level L_j .

Let $z =$ their lowest common ancestor in BFS tree.

Let L_i be level containing z .

Consider cycle that takes edge from x to y , then tree from y to z , then tree from z to x .

Its length is $1 + (j-i) + (j-i)$, which is odd.

$$\underbrace{1}_{(x, y)} + \underbrace{(j-i)}_{\text{path from } y \text{ to } z} + \underbrace{(j-i)}_{\text{path from } z \text{ to } x}$$

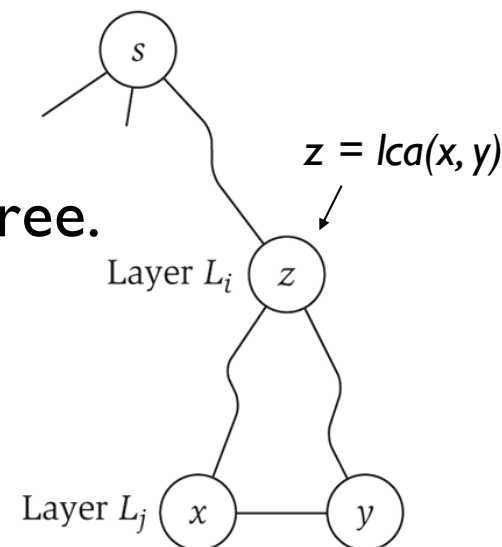

Obstruction to Bipartiteness

Cor: A graph G is bipartite iff it contains no odd length cycle.

NB: the proof is algorithmic—it finds a coloring or odd cycle.

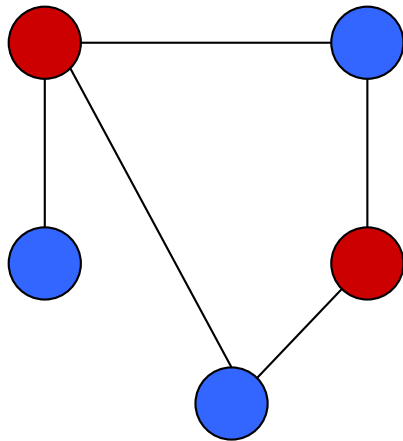

*bipartite
(2-colorable)*

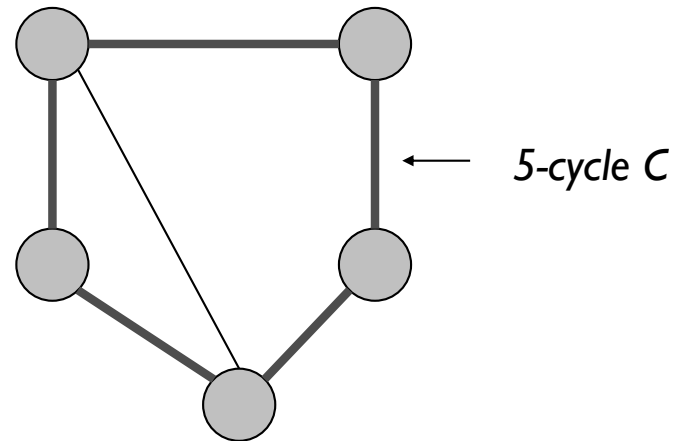

*not bipartite
(not 2-colorable)*

3.6 DAGs and Topological Ordering

This should be review of 331/373 material

I won't lecture on it, but you should read book/slides to be sure it makes sense, with emphasis on correctness, analysis.

Precedence Constraints

Precedence constraints. Edge (v_i, v_j) means task v_i must occur before v_j .

Many Applications

Course prerequisites: course v_i must be taken before v_j

Compilation: must compile module v_i before v_j

Computing workflow: output of job v_i is input to job v_j

Manufacturing or assembly: sand it before you paint it...

Spreadsheet evaluation order: if A7 is " $=A6+A5+A4$ ", evaluate 4,5,6 first

Directed Acyclic Graphs

Def. A **DAG** is a directed acyclic graph, i.e., one that contains no directed cycles.

Ex. Precedence constraints: edge (v_i, v_j) means v_i must precede v_j .

Def. A **topological order** of a directed graph $G = (V, E)$ is an ordering of its nodes as v_1, v_2, \dots, v_n so that for every edge (v_i, v_j) we have $i < j$.

E.g., \forall edge (v_i, v_j) , finish v_i before starting v_j

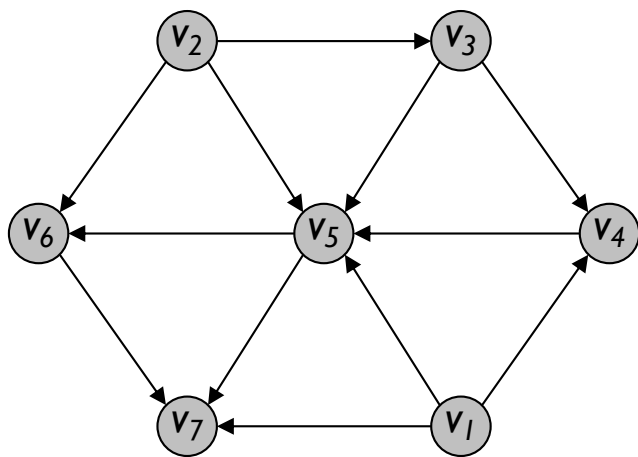

a DAG

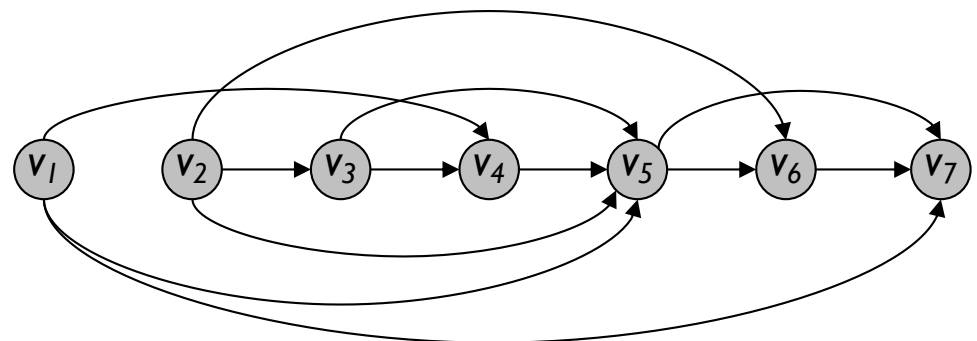

a topological ordering of that DAG—
all edges oriented left-to-right

Directed Acyclic Graphs

Lemma. If G has a topological order, then G is a DAG.

if all edges go $L \rightarrow R$,
you can't loop back
to close a cycle

Pf. (by contradiction)

Suppose that G has a topological order v_1, \dots, v_n
and that G also has a directed cycle C .

Let v_i be the lowest-indexed node in C , and let v_j be the node just
before v_i ; thus (v_j, v_i) is an edge.

By our choice of i , we have $i < j$.

On the other hand, since (v_j, v_i) is an edge and v_1, \dots, v_n is a topological
order, we must have $j < i$, a contradiction.

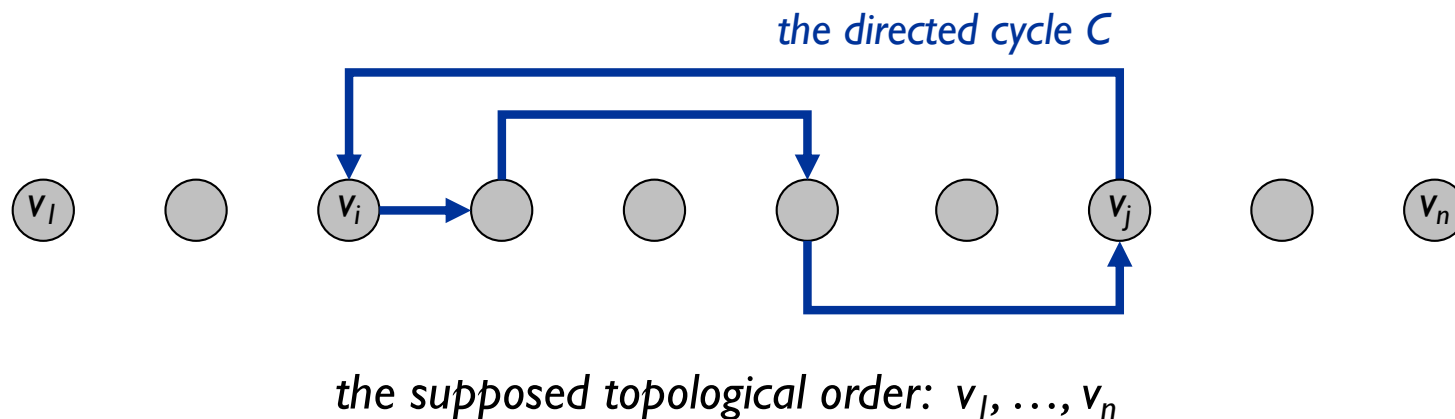

Directed Acyclic Graphs

Lemma (above).

If G has a topological order, then G is a DAG.

Q. Does every DAG have a topological ordering?

Q. If so, how do we compute one?

Directed Acyclic Graphs

Lemma. If G is a DAG, then G has a node with no incoming edges.

Pf. (by contradiction)

Suppose that G is a DAG and every node has at least one incoming edge. Let's see what happens.

Pick any node v , and begin following edges *backward* from v . Since v has at least one incoming edge (u, v) we can walk backward to u .

Then, since u has at least one incoming edge (x, u) , we can walk backward to x .

Repeat until we visit a node, say w , twice.

Let C be the sequence of nodes encountered

between successive visits to w . C is a cycle, contradicting acyclicity.

Why must
this happen?

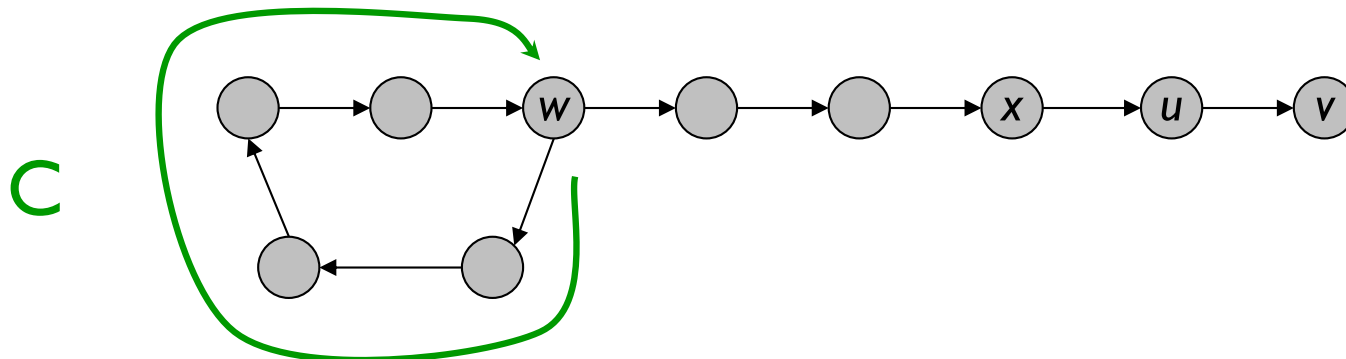

Directed Acyclic Graphs

Lemma. If G is a DAG, then G has a topological ordering.

Pf. (by induction on n)

Base case: true if $n = 1$.

Given DAG on $n > 1$ nodes, find a node v with no incoming edges.

$G - \{v\}$ is a DAG, since deleting v cannot create cycles.

By inductive hypothesis, $G - \{v\}$ has a topological ordering.

Place v first in topological ordering; then append nodes of $G - \{v\}$ in topological order. This is valid since v has no incoming edges. ▀

To compute a topological ordering of G :

Find a node v with no incoming edges and order it first

Delete v from G

Recursively compute a topological ordering of $G - \{v\}$

and append this order after v

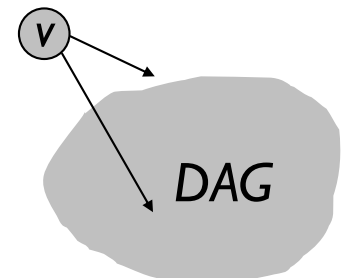

Topological Ordering Algorithm: Example

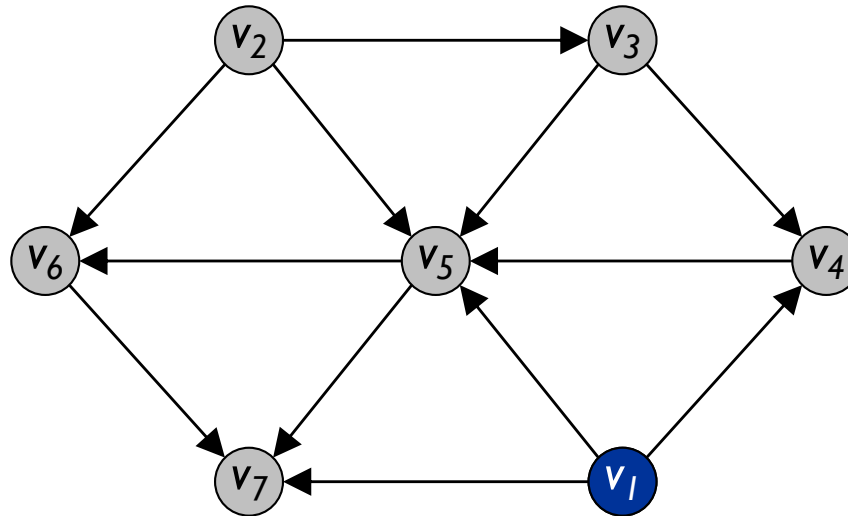

Topological order:

Topological Ordering Algorithm: Example

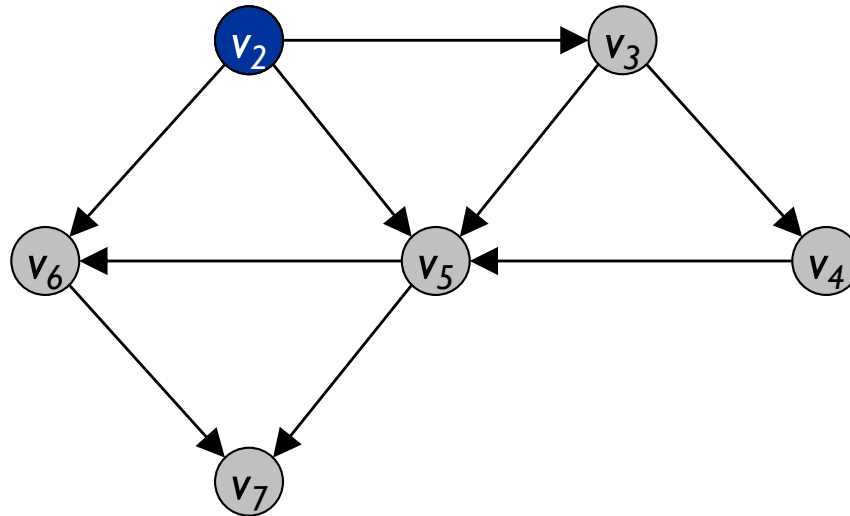

Topological order: v_1

Topological Ordering Algorithm: Example

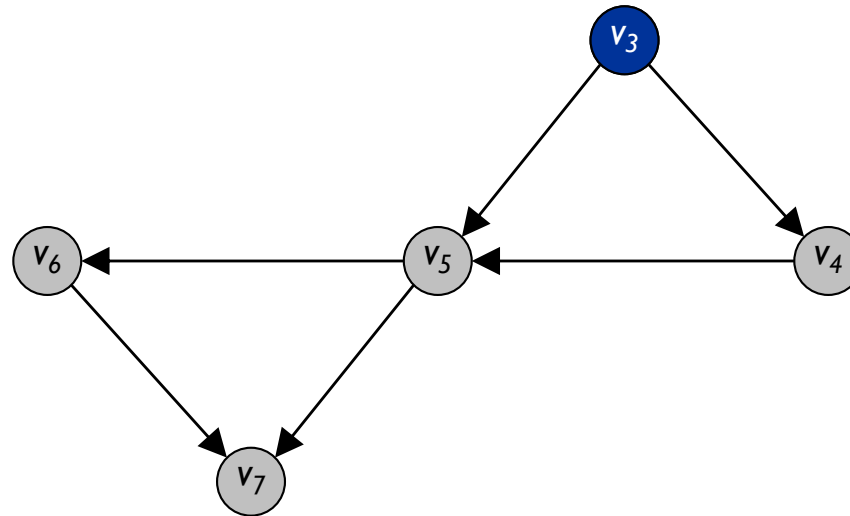

Topological order: v_1, v_2

Topological Ordering Algorithm: Example

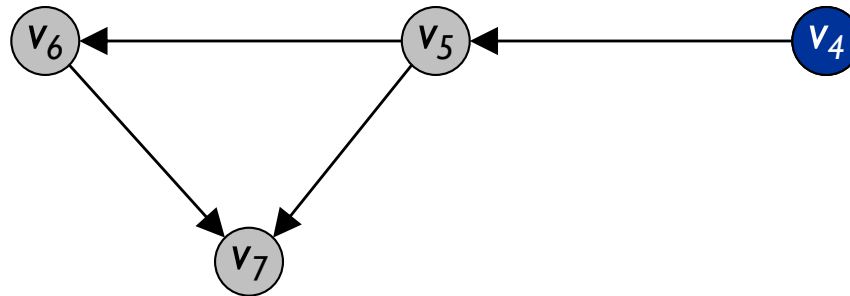

Topological order: v_1, v_2, v_3

Topological Ordering Algorithm: Example

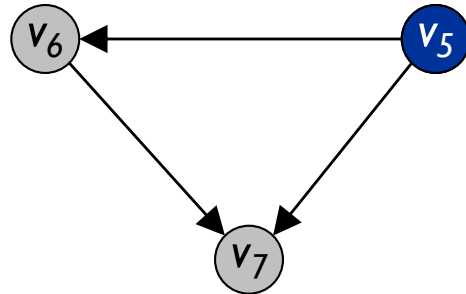

Topological order: v_1, v_2, v_3, v_4

Topological Ordering Algorithm: Example

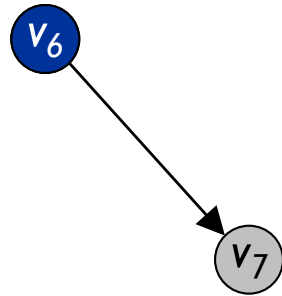

Topological order: v_1, v_2, v_3, v_4, v_5

Topological Ordering Algorithm: Example



Topological order: $v_1, v_2, v_3, v_4, v_5, v_6$

Topological Ordering Algorithm: Example

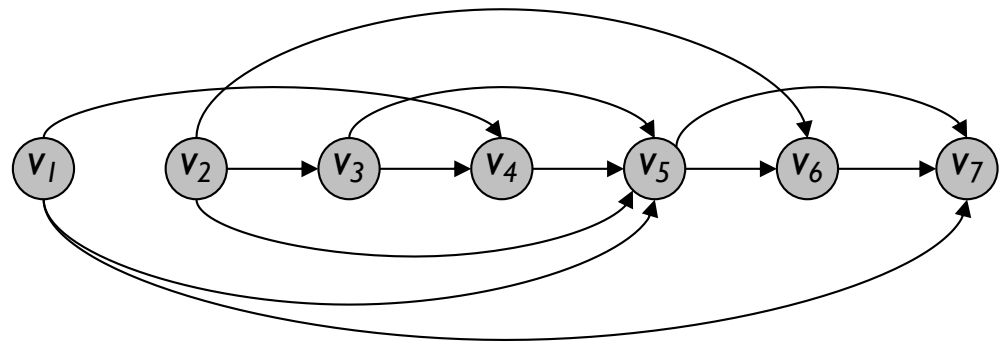
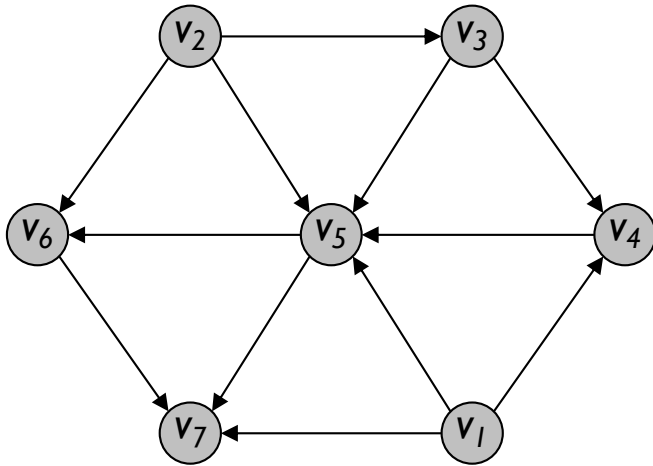

Topological order: $v_1, v_2, v_3, v_4, v_5, v_6, v_7$.

Topological Sorting Algorithm

Maintain the following:

$\text{count}[w]$ = (remaining) number of incoming edges to node w

S = set of (remaining) nodes with no incoming edges

Initialization:

$\text{count}[w] = 0$ for all w

$\text{count}[w]++$ for all edges (v,w)

$S = S \cup \{w\}$ for all w with $\text{count}[w] == 0$

} $O(m + n)$

Main loop:

while S not empty

 remove some v from S

 make v next in topo order

 for all edges from v to some w

$\text{count}[w]--$

 if $\text{count}[w] == 0$ then add w to S

} $O(1)$ per node
} $O(1)$ per edge

why does it terminate?

Correctness: clear, I hope

what if G has cycle?

Time: $O(m + n)$ (assuming edge-list representation of graph)

nested loops: why not $n \cdot m$?

Depth-First Search

Depth-First Search

Follow the first path you find as far as you can go

When you reach a dead end, back up to last unexplored edge, then go as far you can. Etc.

Naturally implemented using recursion or a stack

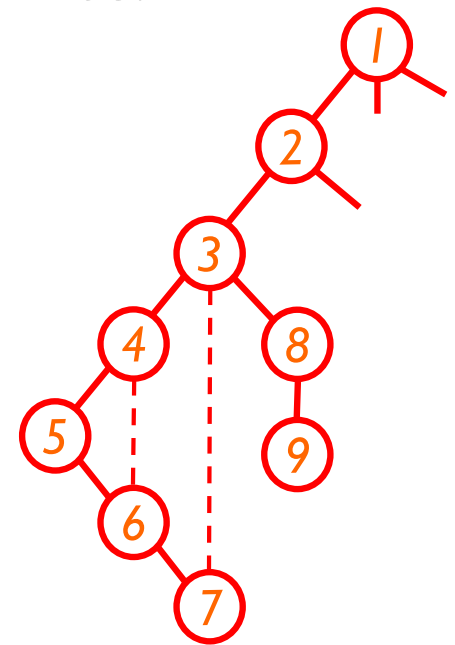

DFS(v) – Recursive version

Global Initialization:

```
for all nodes v, v.dfs# = -1 // mark v "undiscovered"  
dfscounter = 0
```

DFS(v):

```
v.dfs# = dfscounter++ // v "discovered", number it  
for each edge (v,x)  
    if (x.dfs# = -1) // tree edge (x previously undiscovered)  
        DFS(x)  
    else ... // code for back-, fwd-, parent-  
            // edges, if needed; mark v  
            // "completed," if needed
```

Why fuss about trees (again)?

BFS tree \neq DFS tree, but, as with BFS, DFS has found a tree in the graph s.t. non-tree edges are "simple" – *only descendant/ancestor*

Proof below

DFS(A)

Suppose edge lists at each vertex are sorted alphabetically

Color code:
undiscovered
discovered
fully-explored

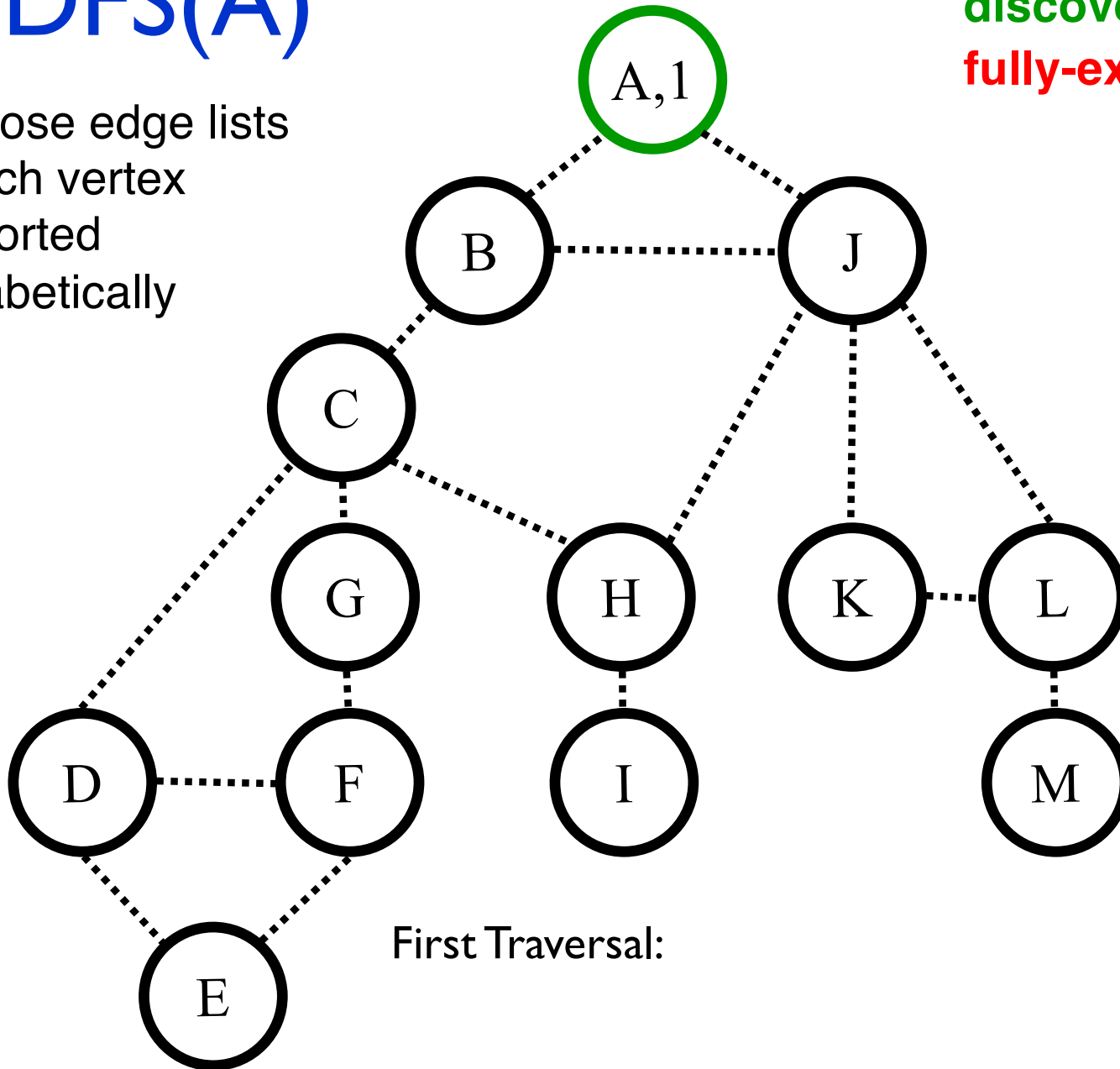

Call Stack (Edge list):
A (B,J)

DFS(A)

Suppose edge lists at each vertex are sorted alphabetically

Color code:
undiscovered
discovered
fully-explored

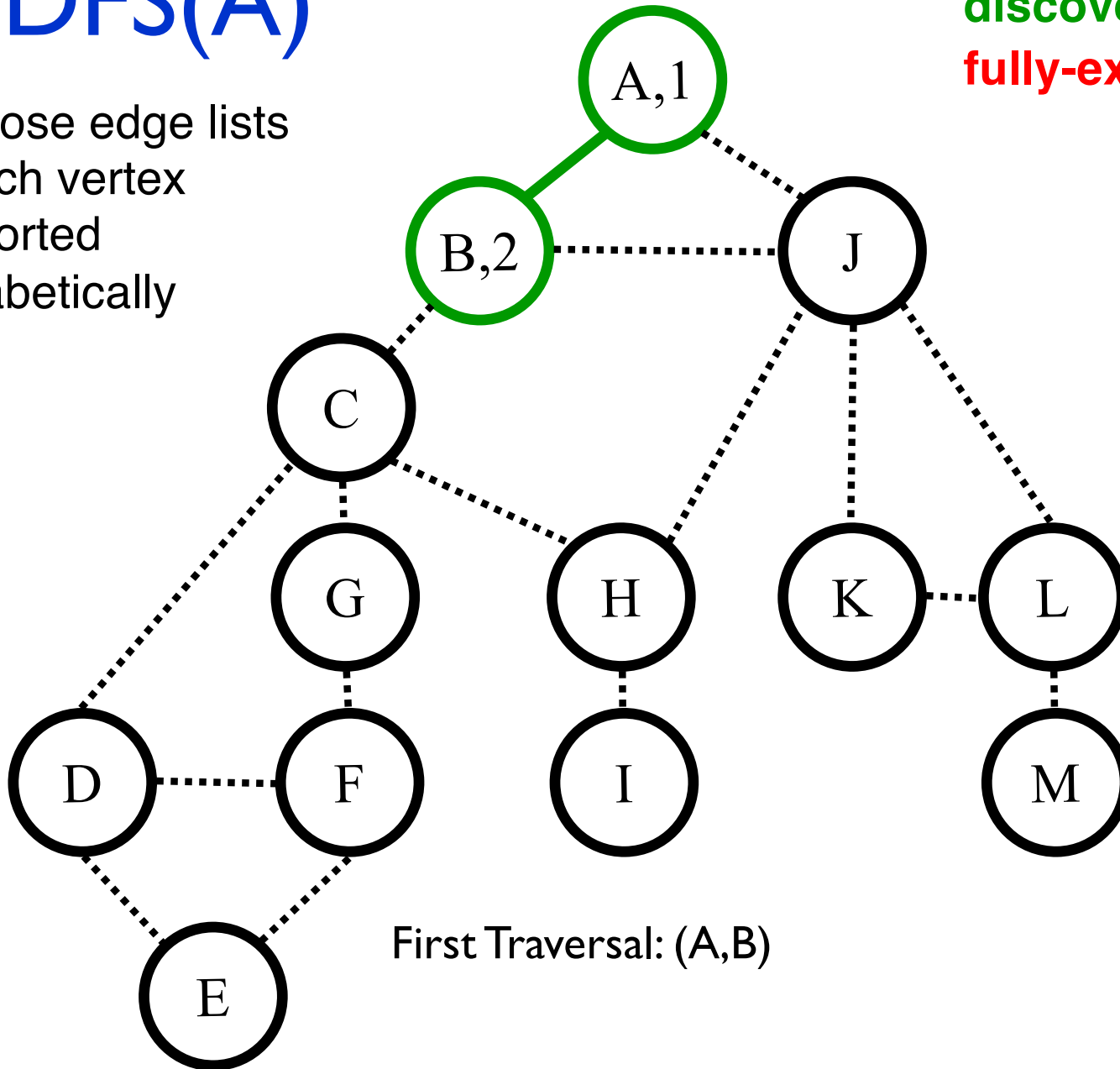

Call Stack: (Edge list)
A (B ,J)
B (A,C,J)

DFS(A)

Suppose edge lists at each vertex are sorted alphabetically

Color code:
undiscovered
discovered
fully-explored

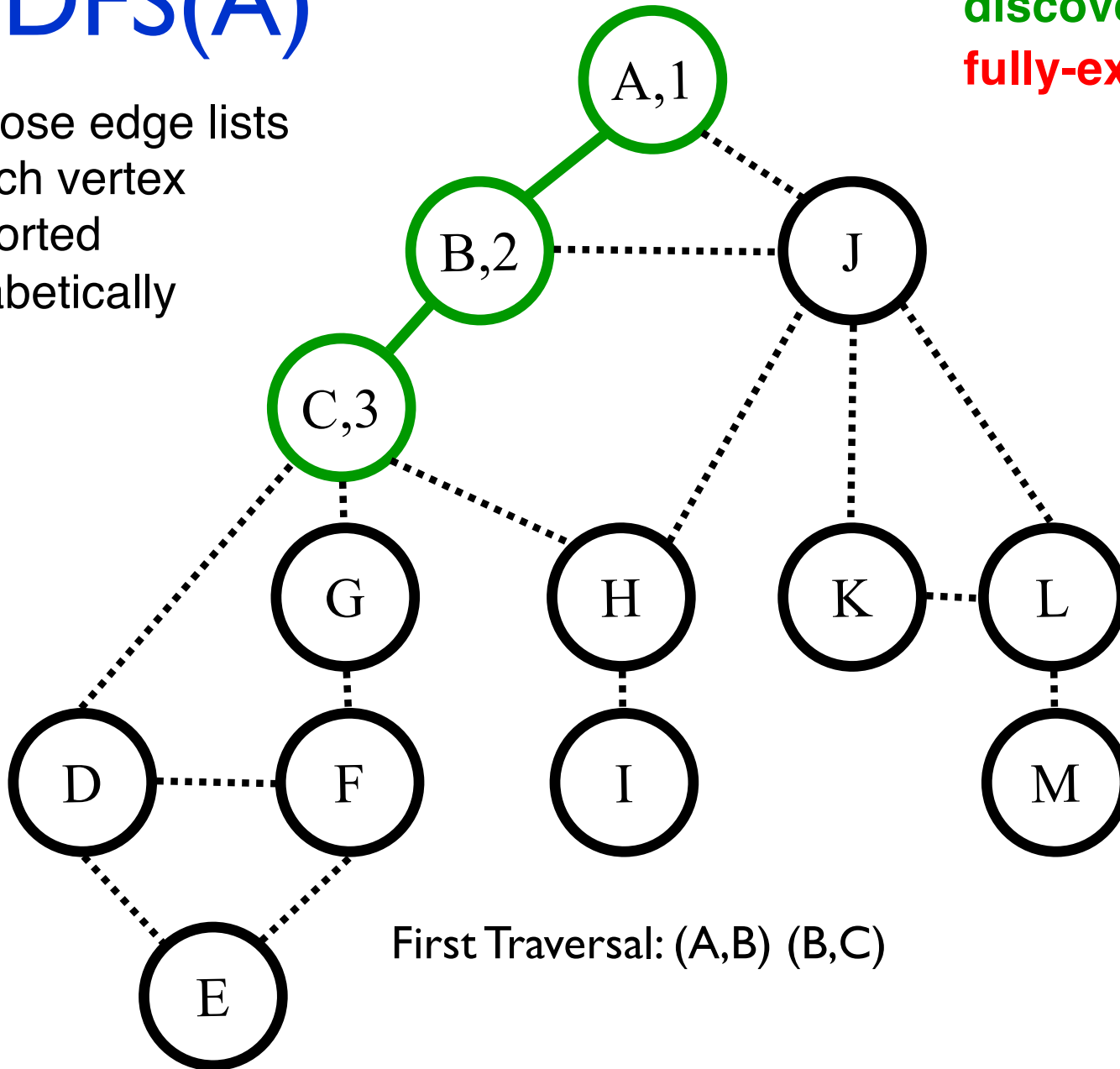

Call Stack: (Edge list)
A (B ,J)
B (A , C ,J)
C (B,D,G,H)

DFS(A)

Suppose edge lists at each vertex are sorted alphabetically

Color code:
undiscovered
discovered
fully-explored

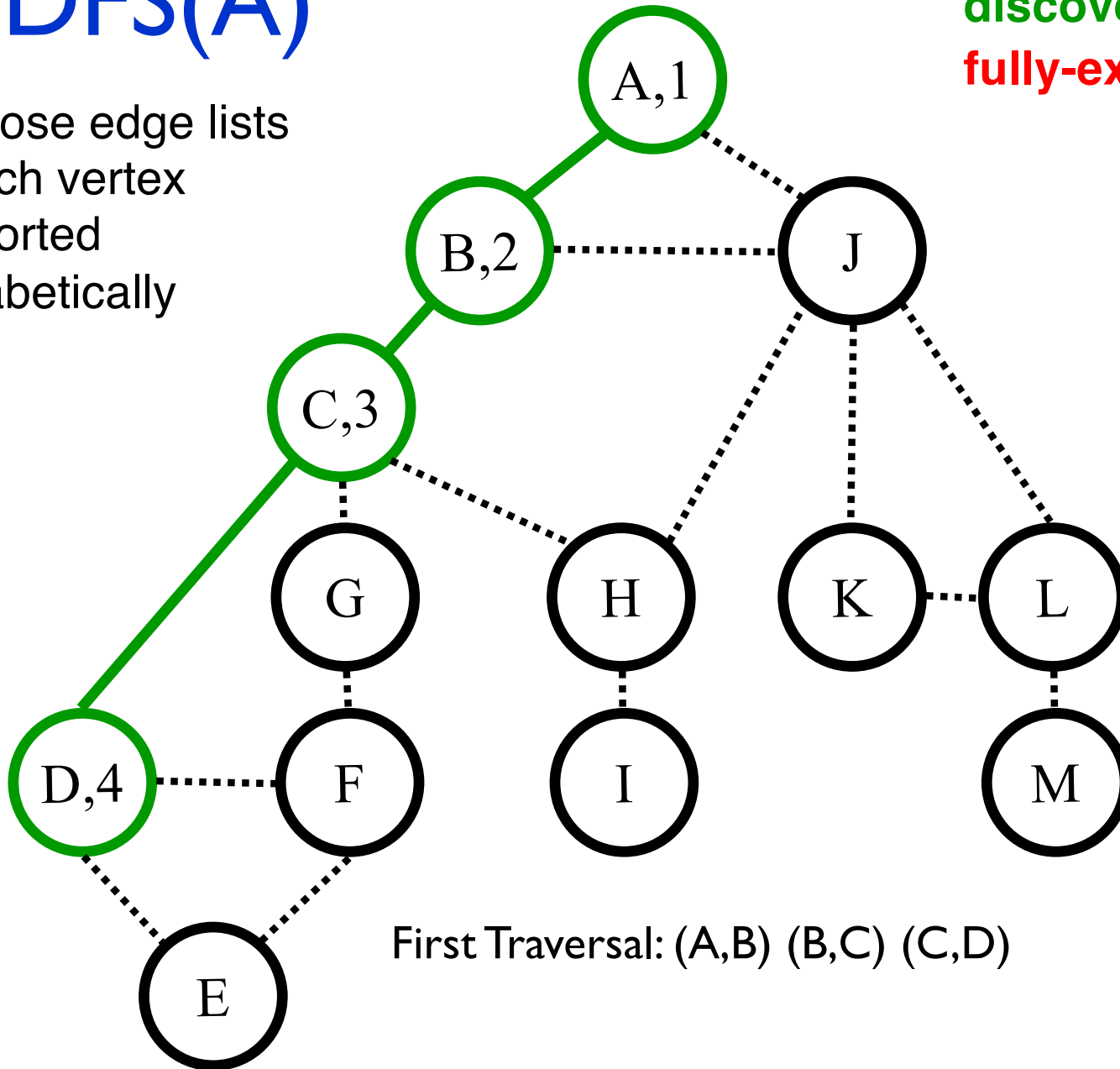

Call Stack: (Edge list)
A (B ,J)
B (A , C ,J)
C (B , D ,G,H)
D (C,E,F)

First Traversal: (A,B) (B,C) (C,D)

DFS(A)

Suppose edge lists at each vertex are sorted alphabetically

Color code:
undiscovered
discovered
fully-explored

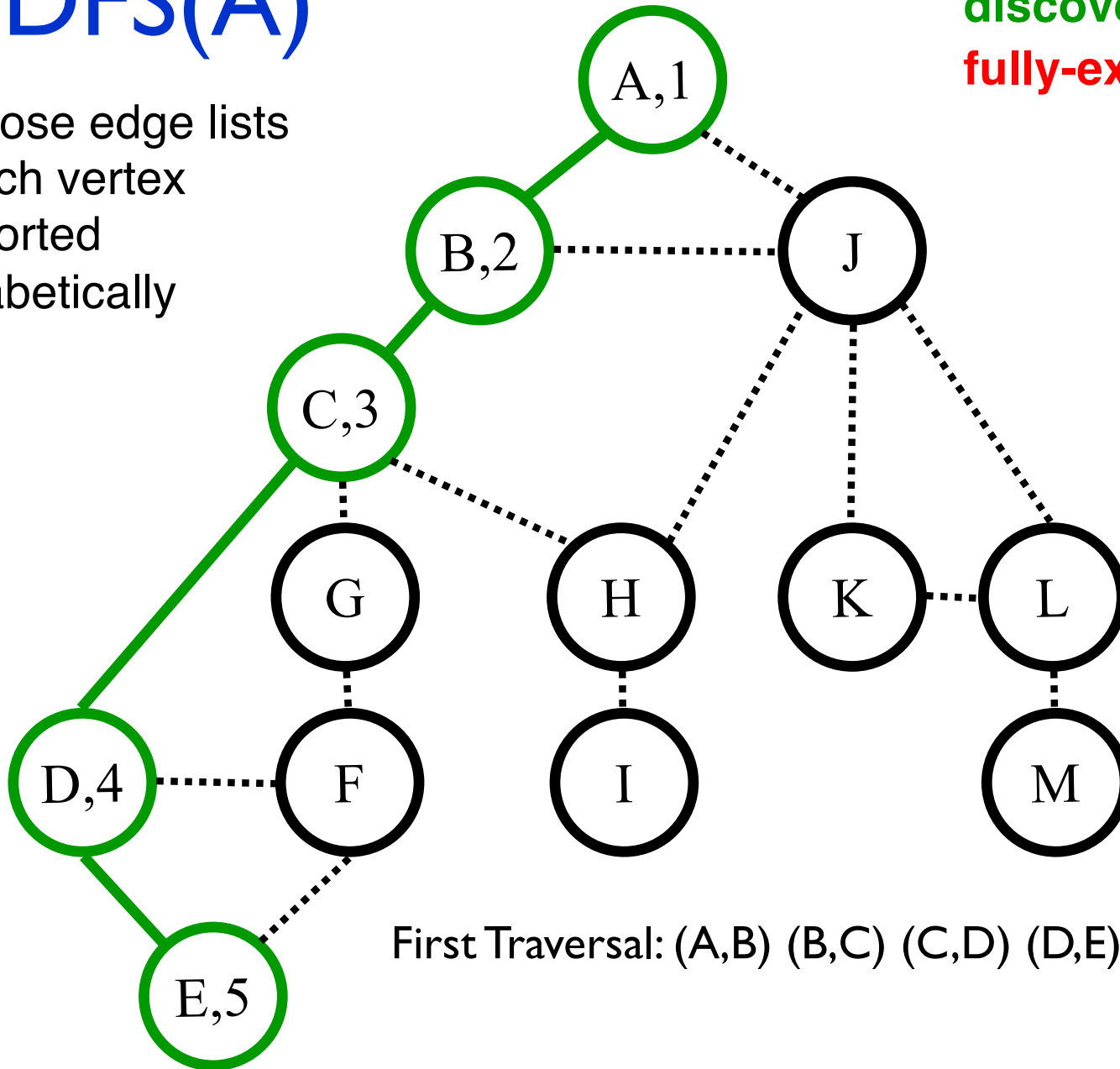

Call Stack: (Edge list)
A (B ,J)
B (A , C ,J)
C (B , D ,G,H)
D (C , E ,F)
E (D,F)

First Traversal: (A,B) (B,C) (C,D) (D,E)

DFS(A)

Suppose edge lists at each vertex are sorted alphabetically

Color code:
undiscovered
discovered
fully-explored

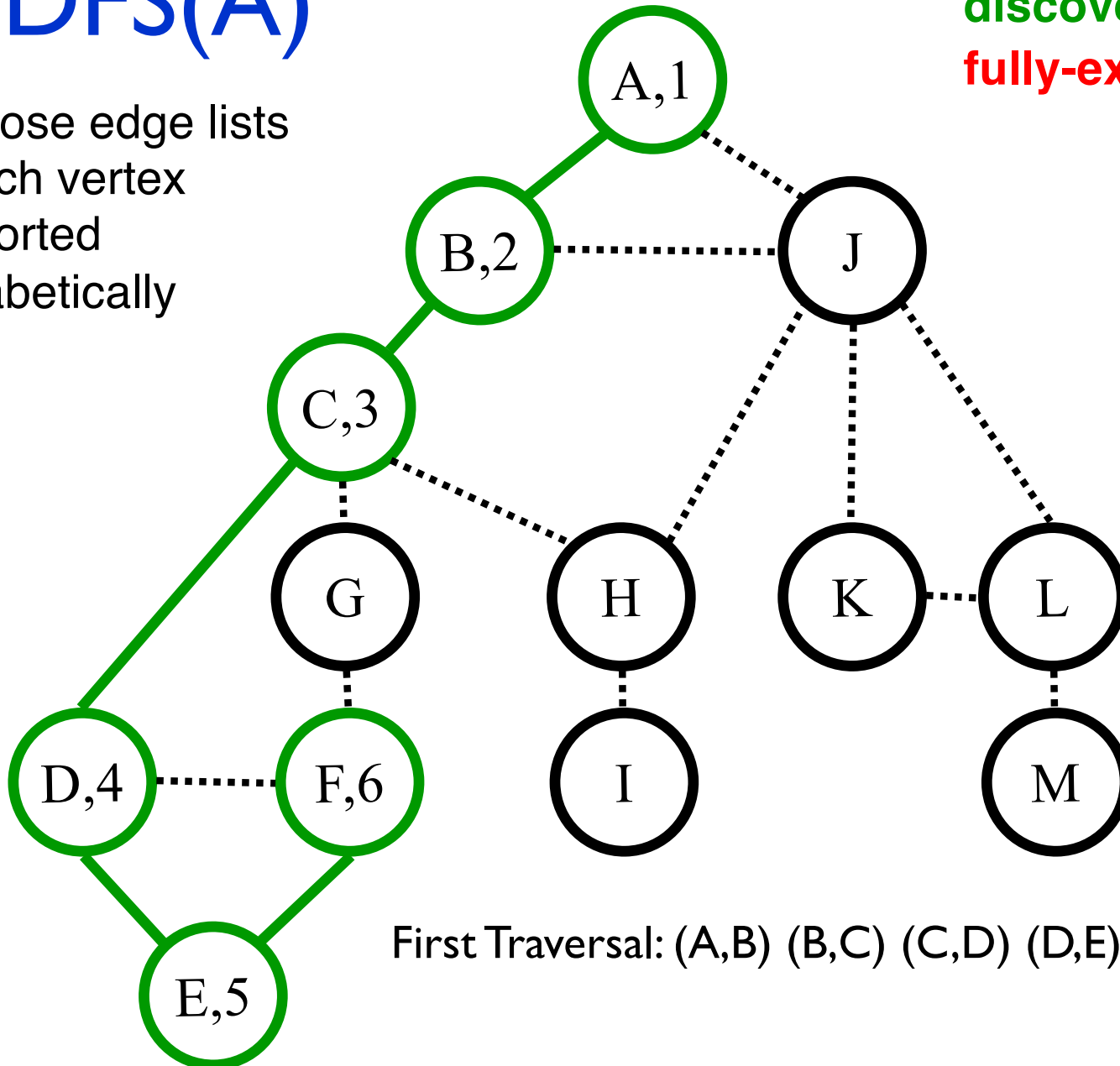

Call Stack: (Edge list)
A (B ,J)
B (A , C ,J)
C (B , D ,G,H)
D (C , E ,F)
E (D , F)
F (D,E,G)

First Traversal: (A,B) (B,C) (C,D) (D,E) (E,F)

DFS(A)

Suppose edge lists at each vertex are sorted alphabetically

Color code:
 undiscovered
 discovered
 fully-explored

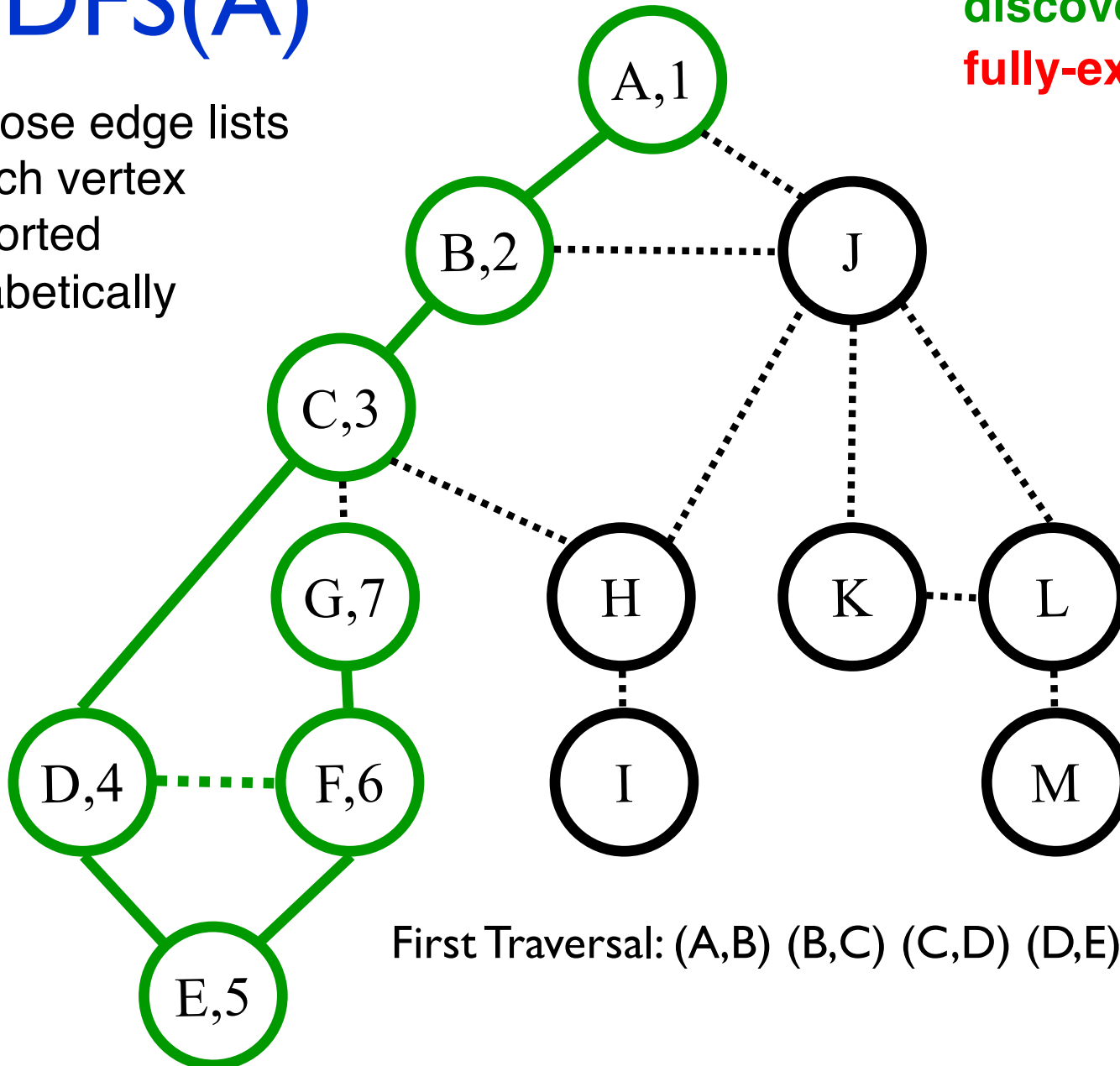

Call Stack: (Edge list)
A (B ,J)
B (A , C ,J)
C (B , D ,G,H)
D (C , E ,F)
E (D , F)
F (D , E , G)
G (C,F)

First Traversal: (A,B) (B,C) (C,D) (D,E) (E,F) (F,D) (F,G)

DFS(A)

Suppose edge lists at each vertex are sorted alphabetically

Color code:
 undiscovered
 discovered
 fully-explored

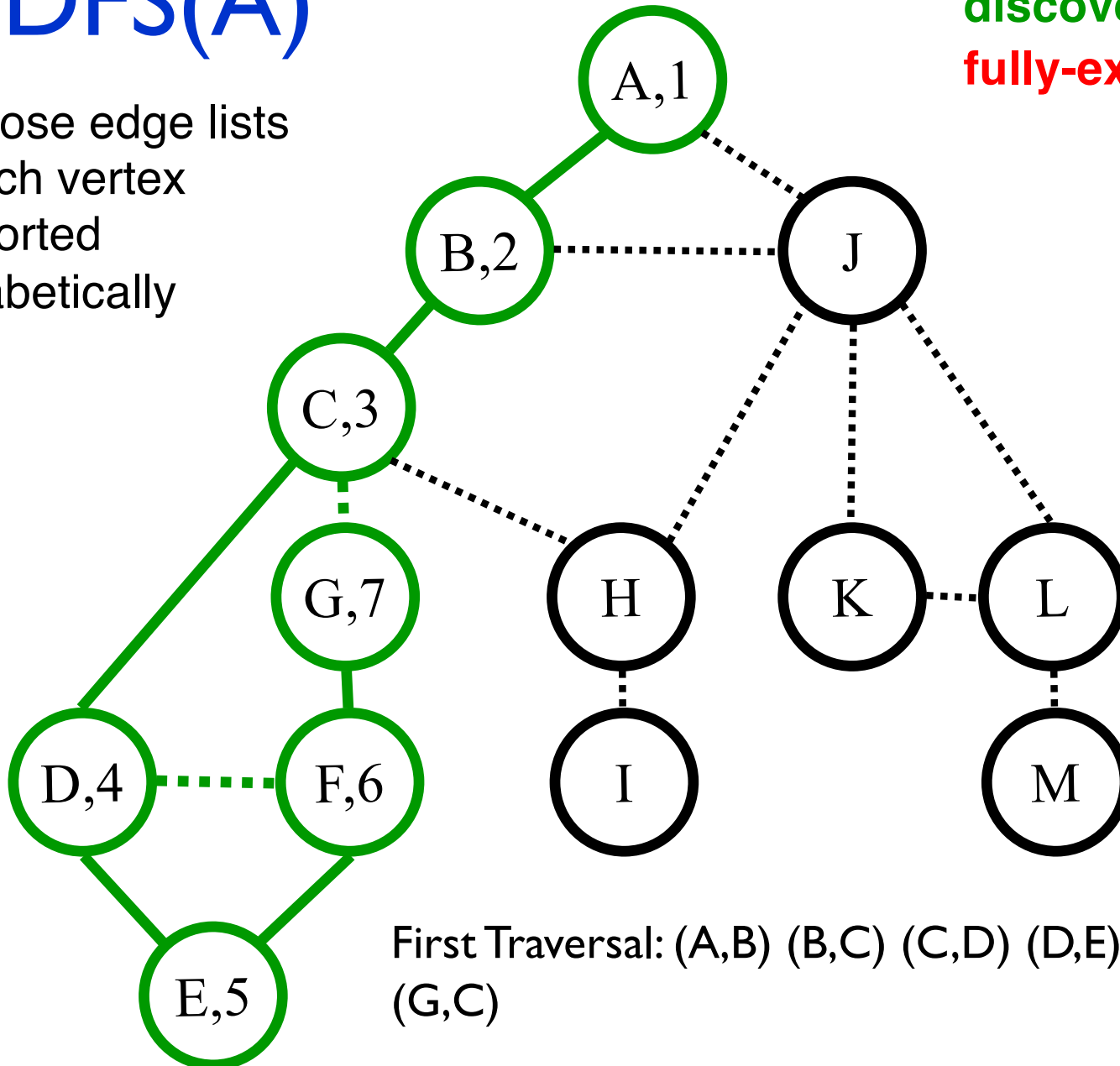

Call Stack: (Edge list)
A (B ,J)
B (A , C ,J)
C (B , D ,G,H)
D (C , E ,F)
E (D , F)
F (D , E , G)
G (C , F)

First Traversal: (A,B) (B,C) (C,D) (D,E) (E,F) (F,D) (F,G)
 (G,C)

DFS(A)

Suppose edge lists at each vertex are sorted alphabetically

Color code:
 undiscovered
 discovered
 fully-explored

Call Stack: (Edge list)
A (B ,J)
B (A , C ,J)
C (B , D ,G,H)
D (C , E ,F)
E (D , F)
F (D , E , G)

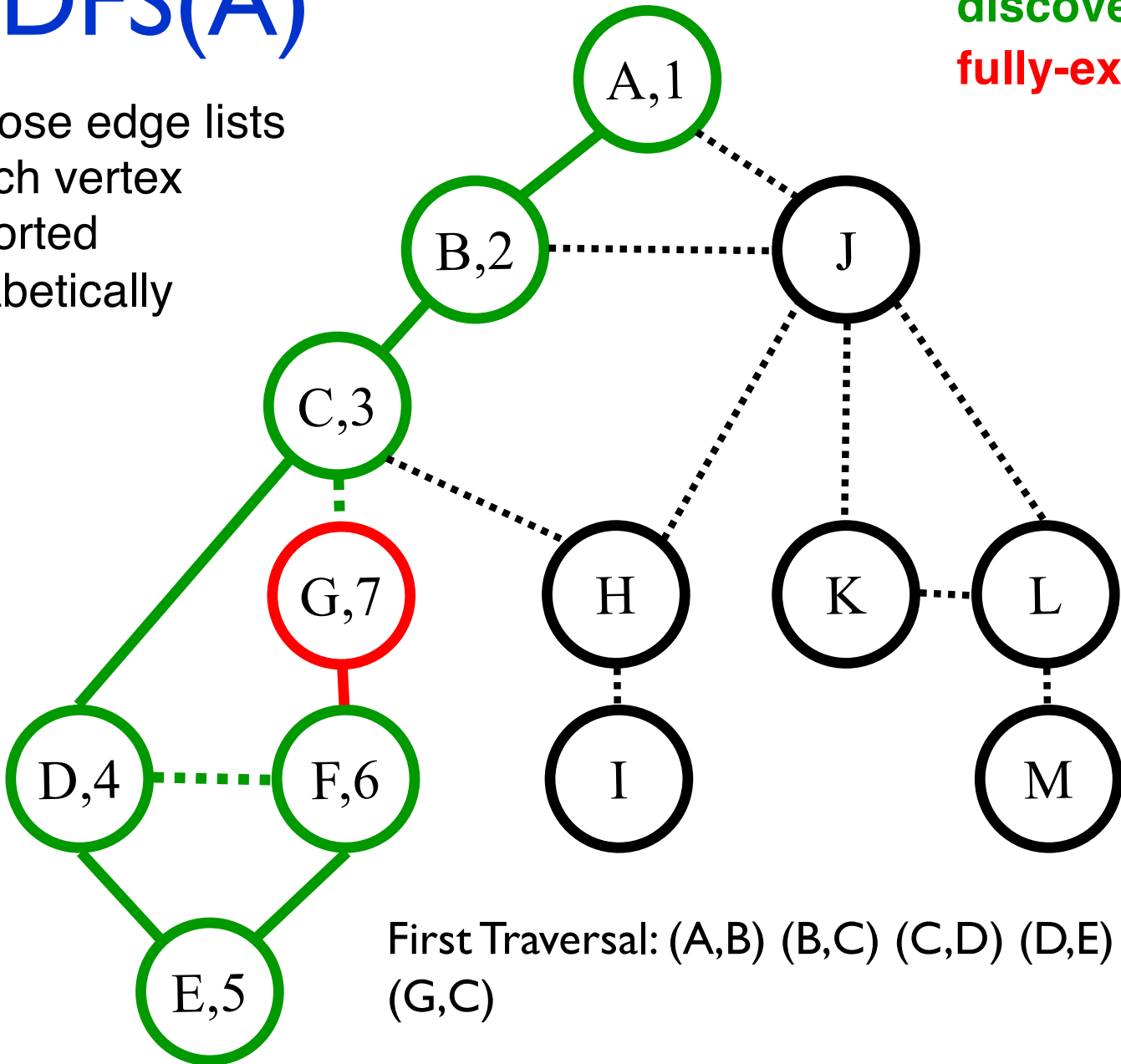

First Traversal: (A,B) (B,C) (C,D) (D,E) (E,F) (F,D) (F,G)
 (G,C)

DFS(A)

Suppose edge lists at each vertex are sorted alphabetically

Color code:
 undiscovered
 discovered
 fully-explored

Call Stack: (Edge list)
A (B ,J)
B (A , C ,J)
C (B , D ,G,H)
D (C , E ,F)
E (D , F)

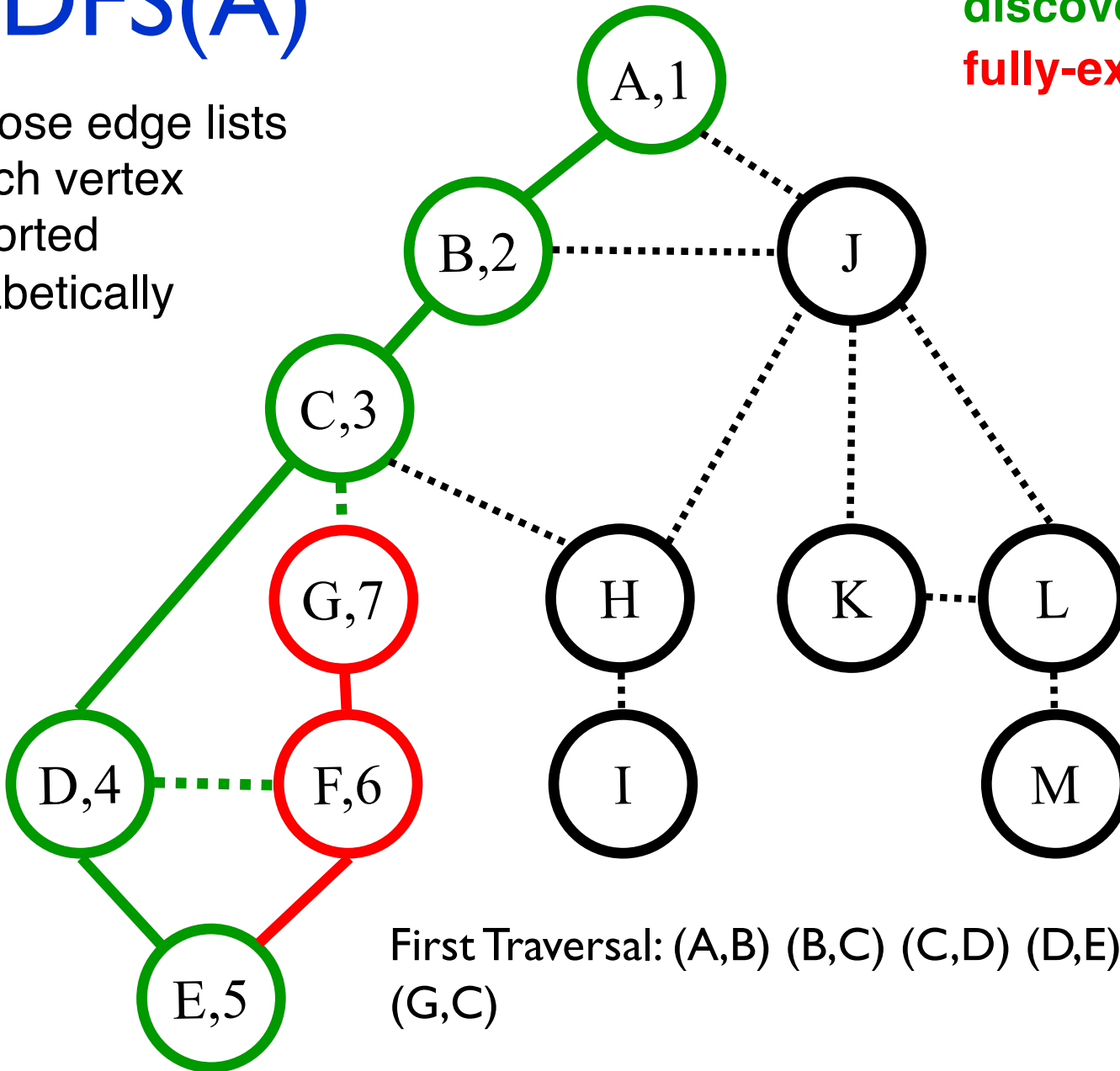

First Traversal: (A,B) (B,C) (C,D) (D,E) (E,F) (F,D) (F,G)
 (G,C)

DFS(A)

Suppose edge lists at each vertex are sorted alphabetically

Color code:
 undiscovered
 discovered
 fully-explored

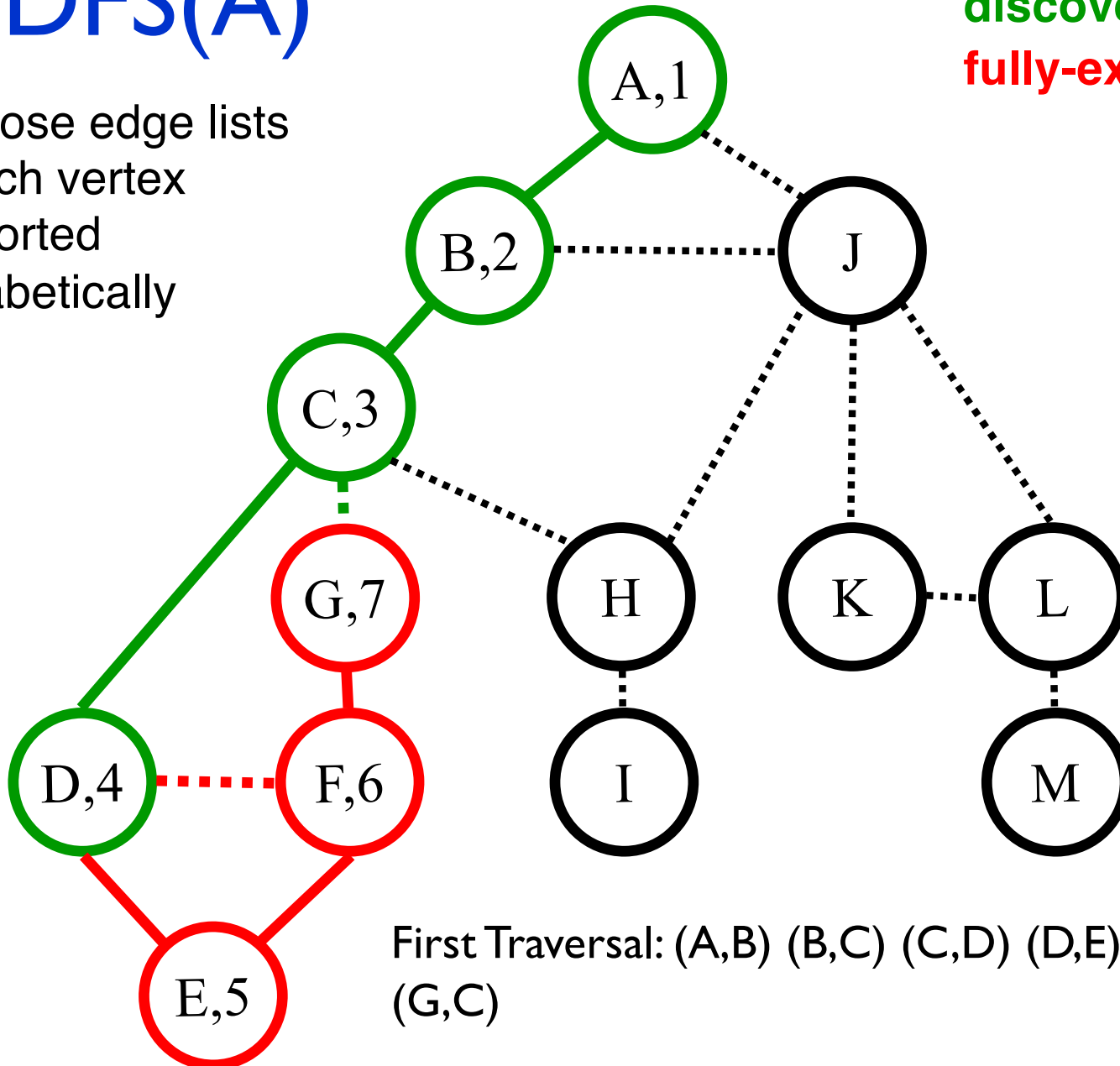

Call Stack: (Edge list)
A (B ,J)
B (A , C ,J)
C (B , D ,G,H)
D (C , E , F)

DFS(A)

Suppose edge lists at each vertex are sorted alphabetically

Color code:
undiscovered
discovered
fully-explored

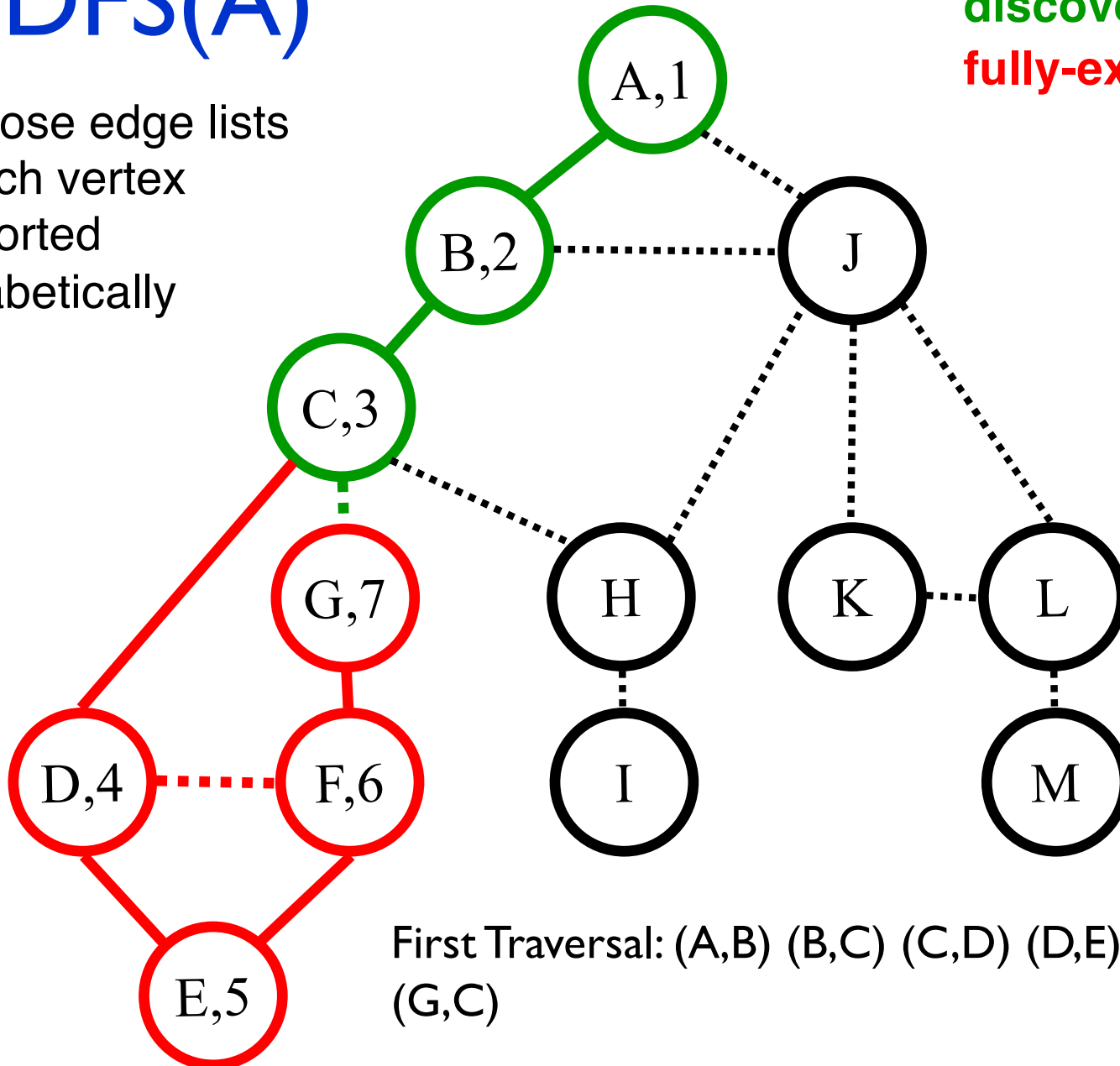

Call Stack: (Edge list)
A (B ,J)
B (A , C ,J)
C (B , D ,G,H)

First Traversal: (A,B) (B,C) (C,D) (D,E) (E,F) (F,D) (F,G)
(G,C)

DFS(A)

Suppose edge lists at each vertex are sorted alphabetically

Color code:
 undiscovered
 discovered
 fully-explored

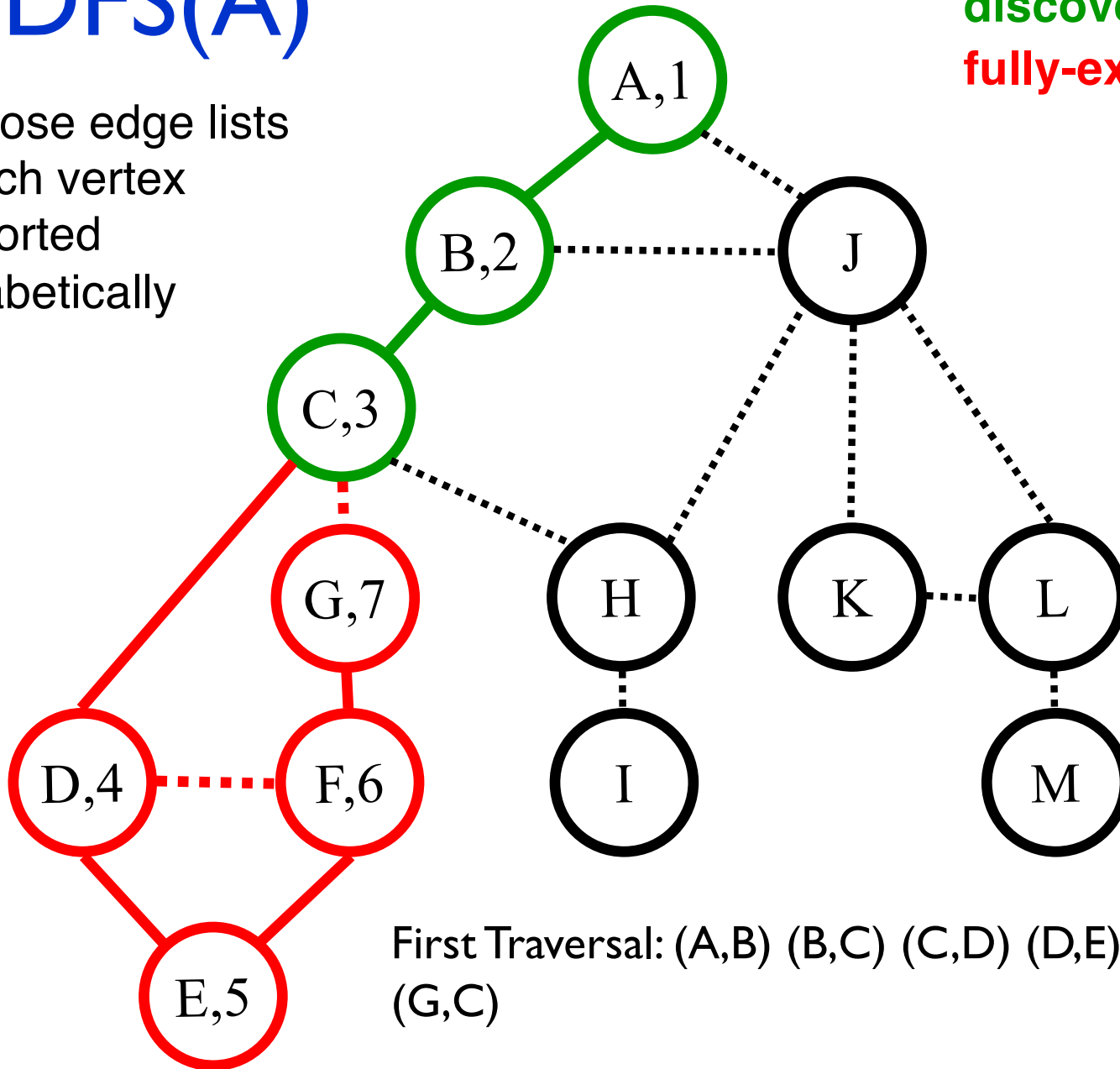

Call Stack: (Edge list)
A (B ,J)
B (A , C ,J)
C (B , D , G ,H)

First Traversal: (A,B) (B,C) (C,D) (D,E) (E,F) (F,D) (F,G)
 (G,C)

DFS(A)

Suppose edge lists at each vertex are sorted alphabetically

Color code:
undiscovered
discovered
fully-explored

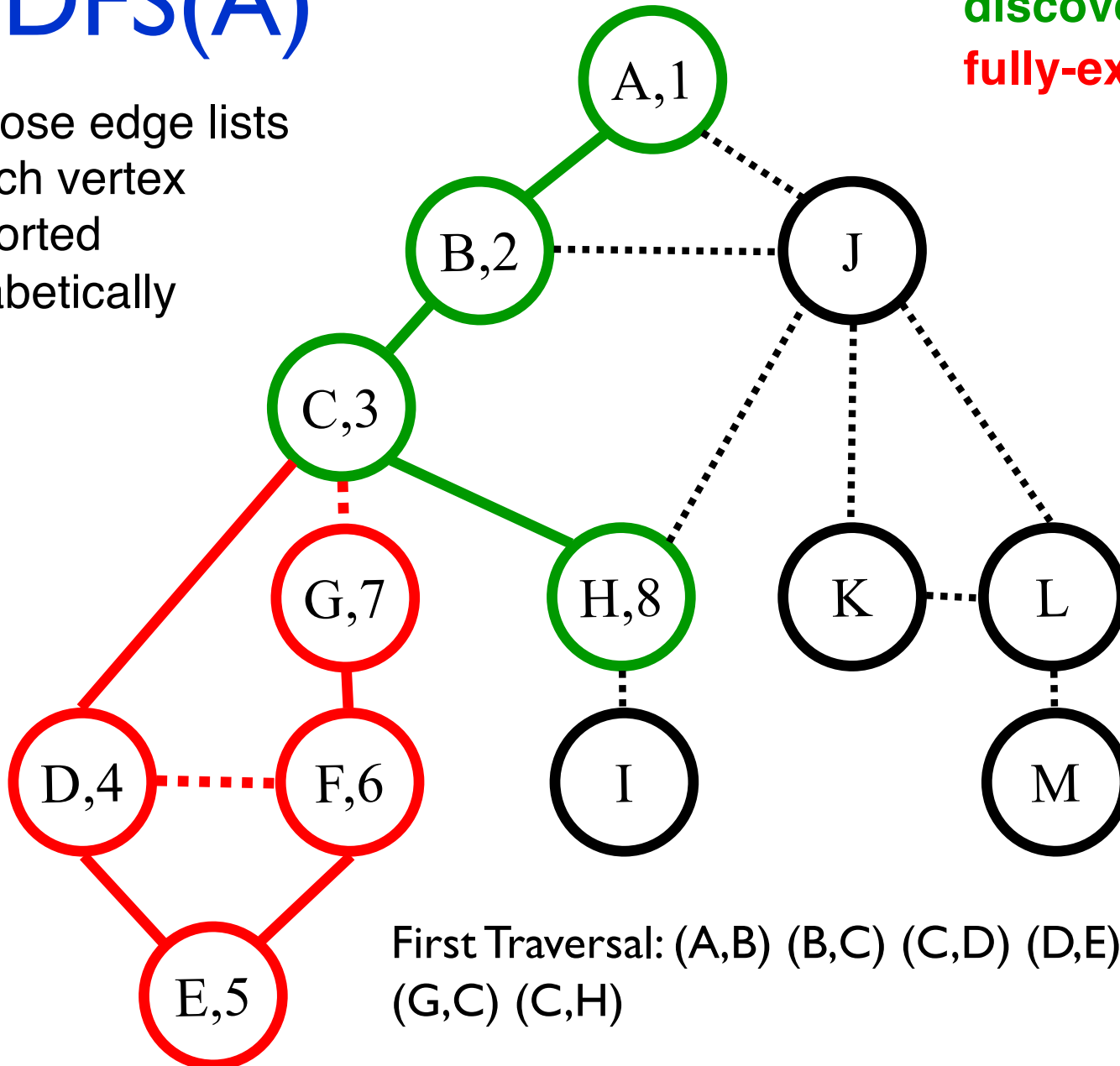

Call Stack: (Edge list)
A (B ,J)
B (A , C ,J)
C (B , D , G , H)
H (C,I,J)

First Traversal: (A,B) (B,C) (C,D) (D,E) (E,F) (F,D) (F,G)
(G,C) (C,H)

DFS(A)

Suppose edge lists at each vertex are sorted alphabetically

Color code:
undiscovered
discovered
fully-explored

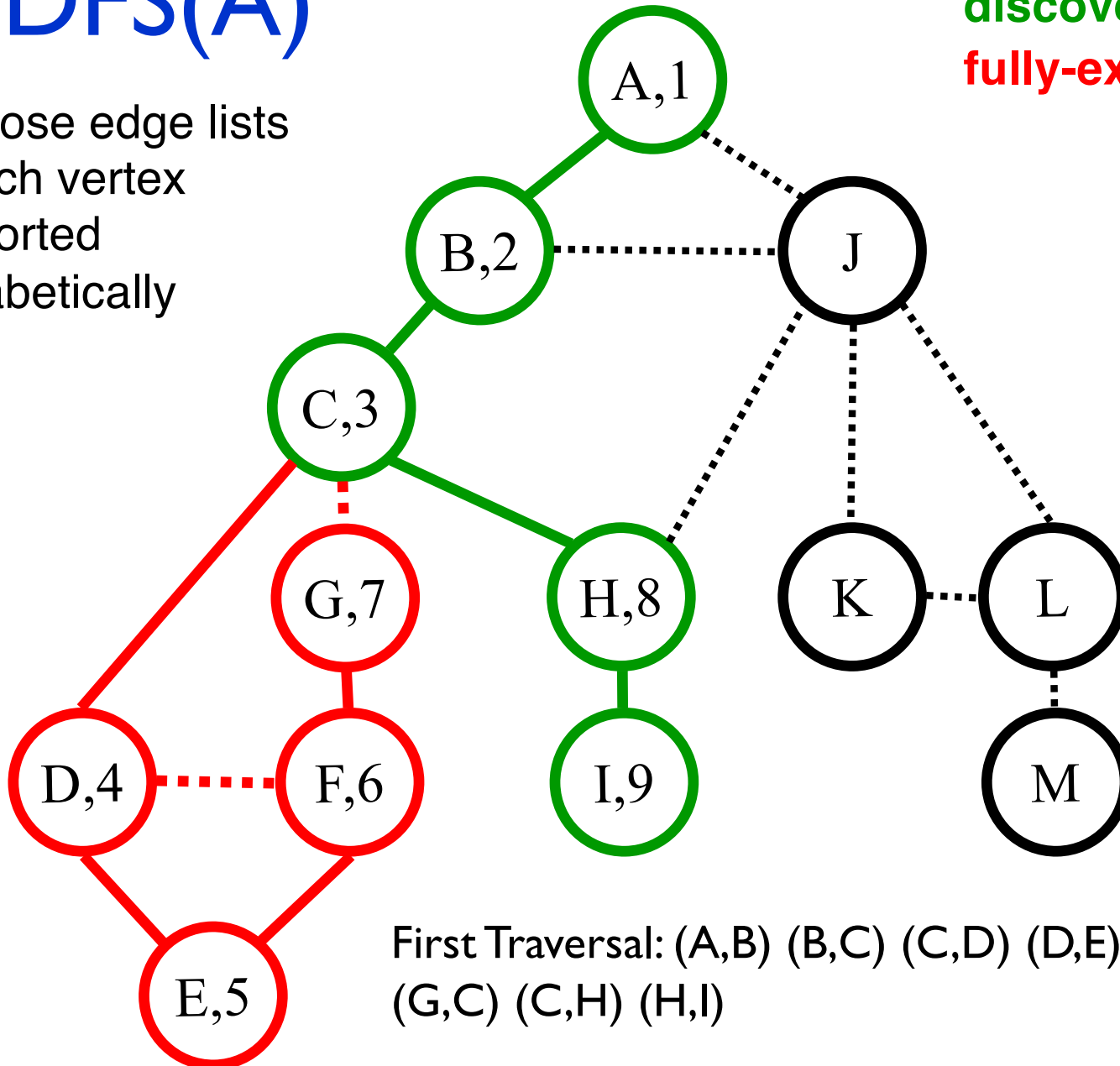

Call Stack: (Edge list)
A (B ,J)
B (A , C ,J)
C (B , D , G ,H)
H (C ,I,J)
I (H)

First Traversal: (A,B) (B,C) (C,D) (D,E) (E,F) (F,D) (F,G)
(G,C) (C,H) (H,I)

DFS(A)

Suppose edge lists at each vertex are sorted alphabetically

Color code:
 undiscovered
 discovered
 fully-explored

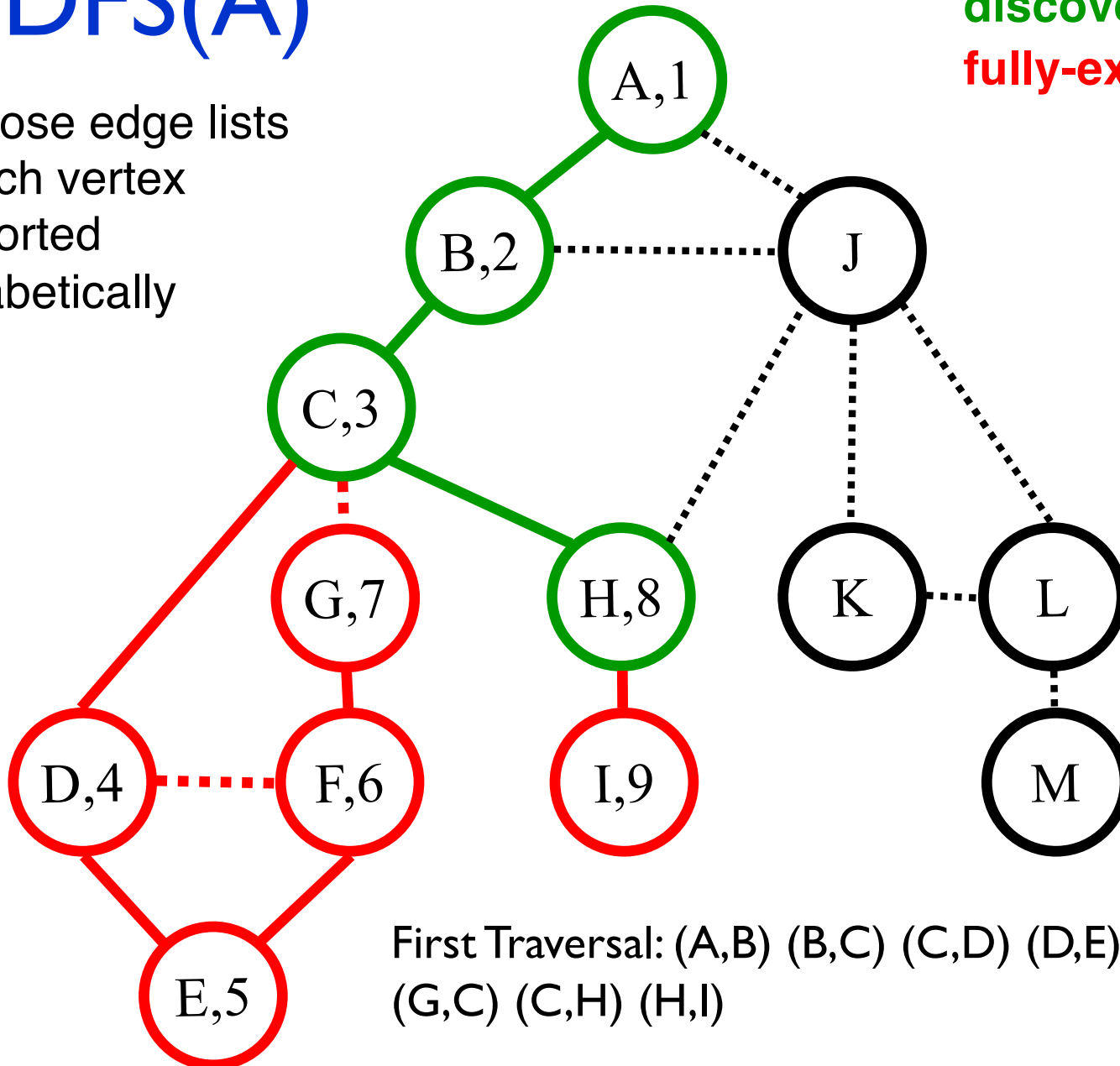

Call Stack: (Edge list)
A (B ,J)
B (A , C ,J)
C (B , D , G ,H)
H (C ,I,J)
I (H)

First Traversal: (A,B) (B,C) (C,D) (D,E) (E,F) (F,D) (F,G)
 (G,C) (C,H) (H,I)

DFS(A)

Suppose edge lists at each vertex are sorted alphabetically

Color code:
 undiscovered
 discovered
 fully-explored

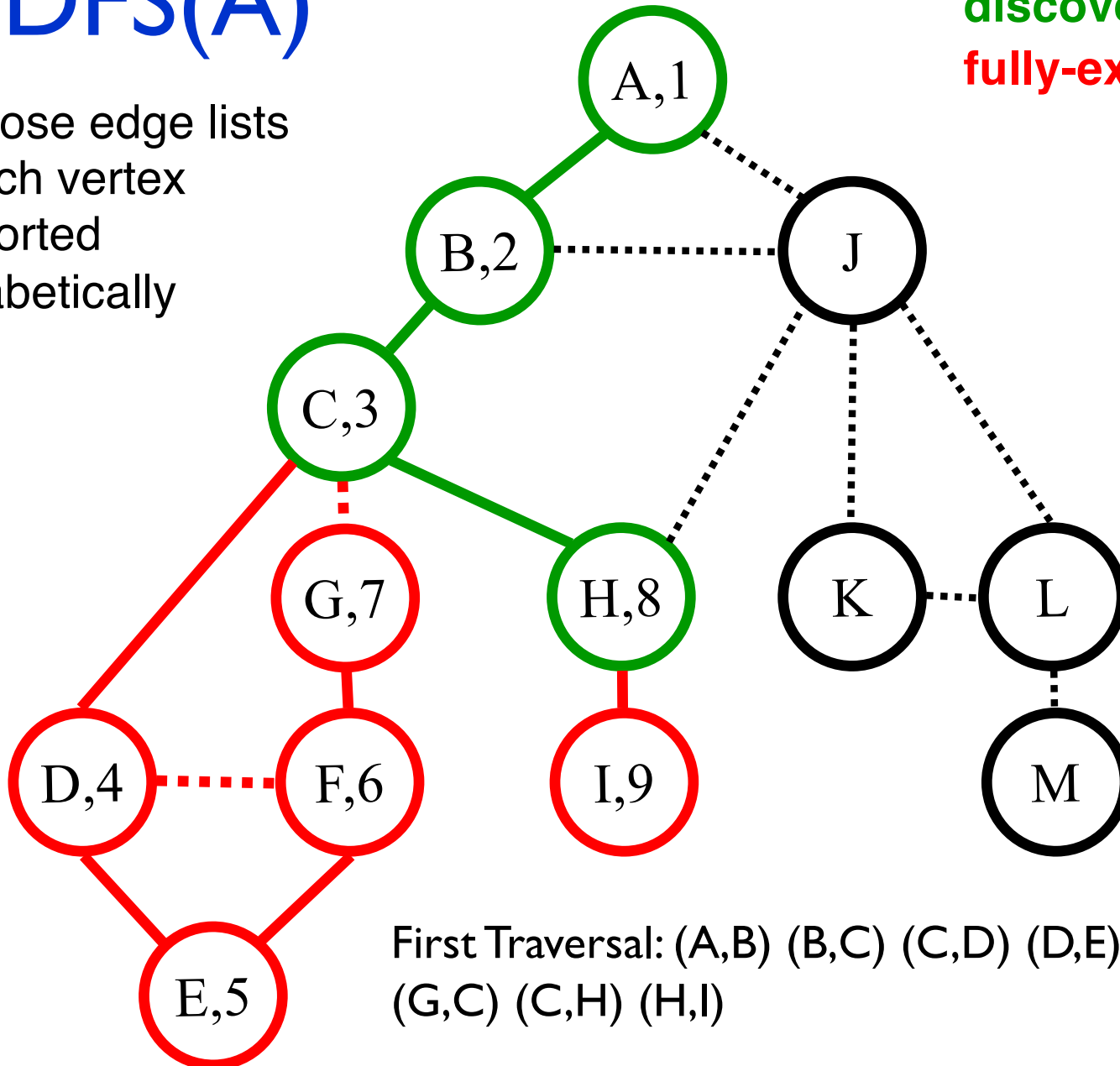

DFS(A)

Suppose edge lists at each vertex are sorted alphabetically

Color code:
 undiscovered
 discovered
 fully-explored

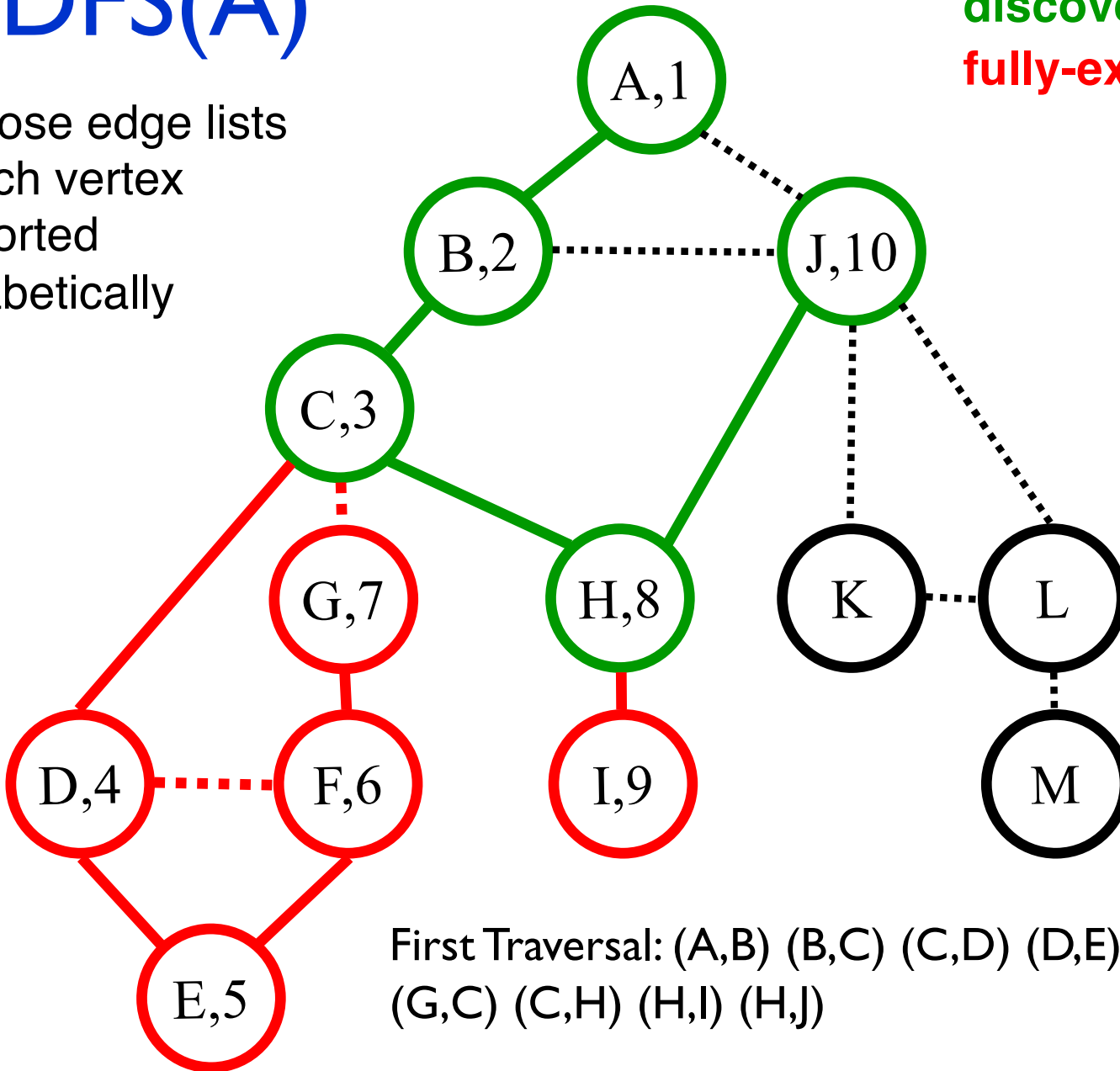

Call Stack: (Edge list)
A (B ,J)
B (A , C ,J)
C (B , D , G ,H)
H (C , I ,J)
J (A,B,H,K,L)

First Traversal: (A,B) (B,C) (C,D) (D,E) (E,F) (F,D) (F,G)
 (G,C) (C,H) (H,I) (H,J)

DFS(A)

Suppose edge lists at each vertex are sorted alphabetically

Color code:
 undiscovered
 discovered
 fully-explored

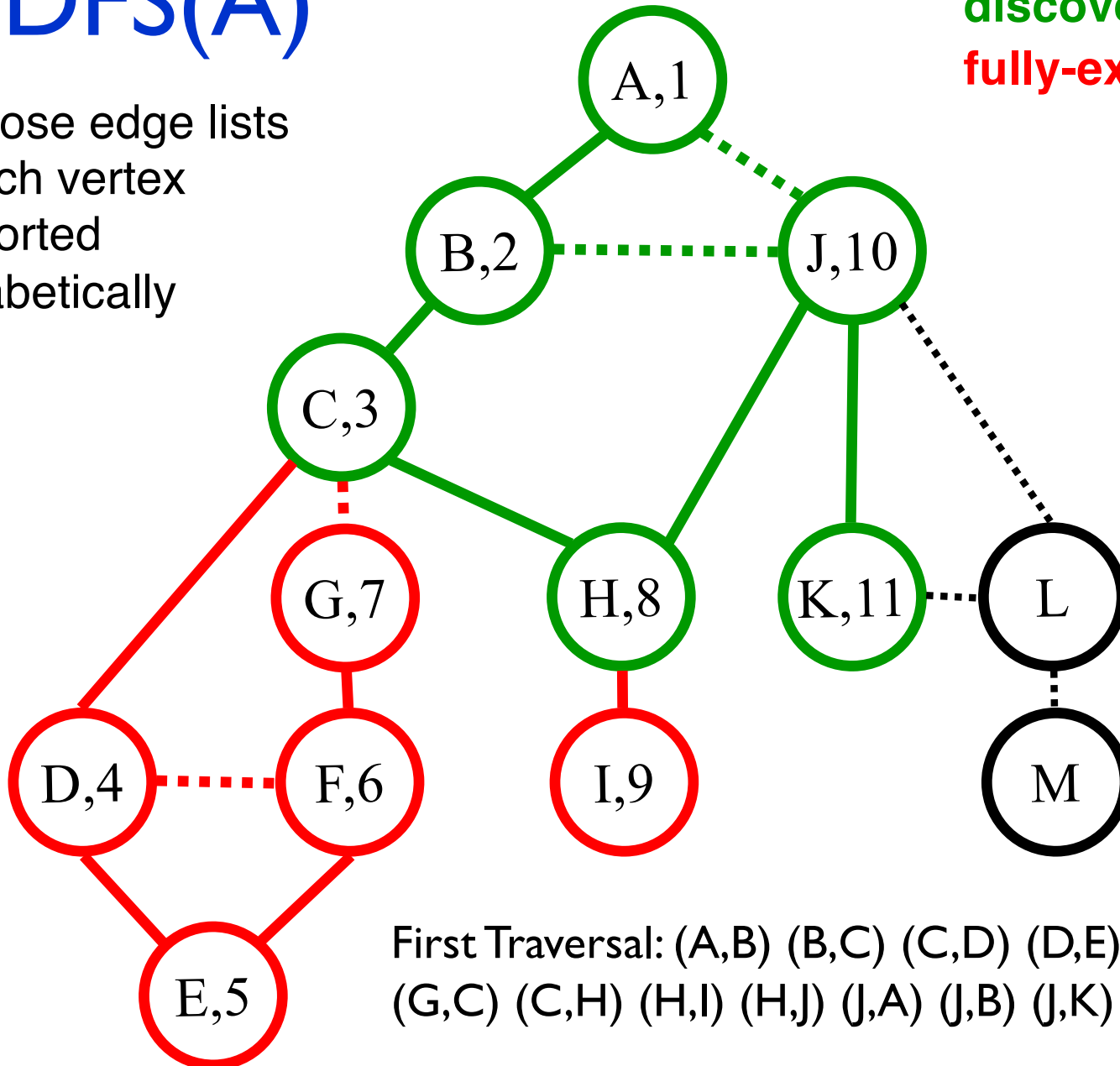

Call Stack: (Edge list)
A (B ,J)
B (A , C ,J)
C (B , D , G ,H)
H (C ,I,J)
J (A , B , H , K ,L)
K (J,L)

First Traversal: (A,B) (B,C) (C,D) (D,E) (E,F) (F,D) (F,G)
 (G,C) (C,H) (H,I) (H,J) (J,A) (J,B) (J,K)

DFS(A)

Suppose edge lists at each vertex are sorted alphabetically

Color code:
 undiscovered
 discovered
 fully-explored

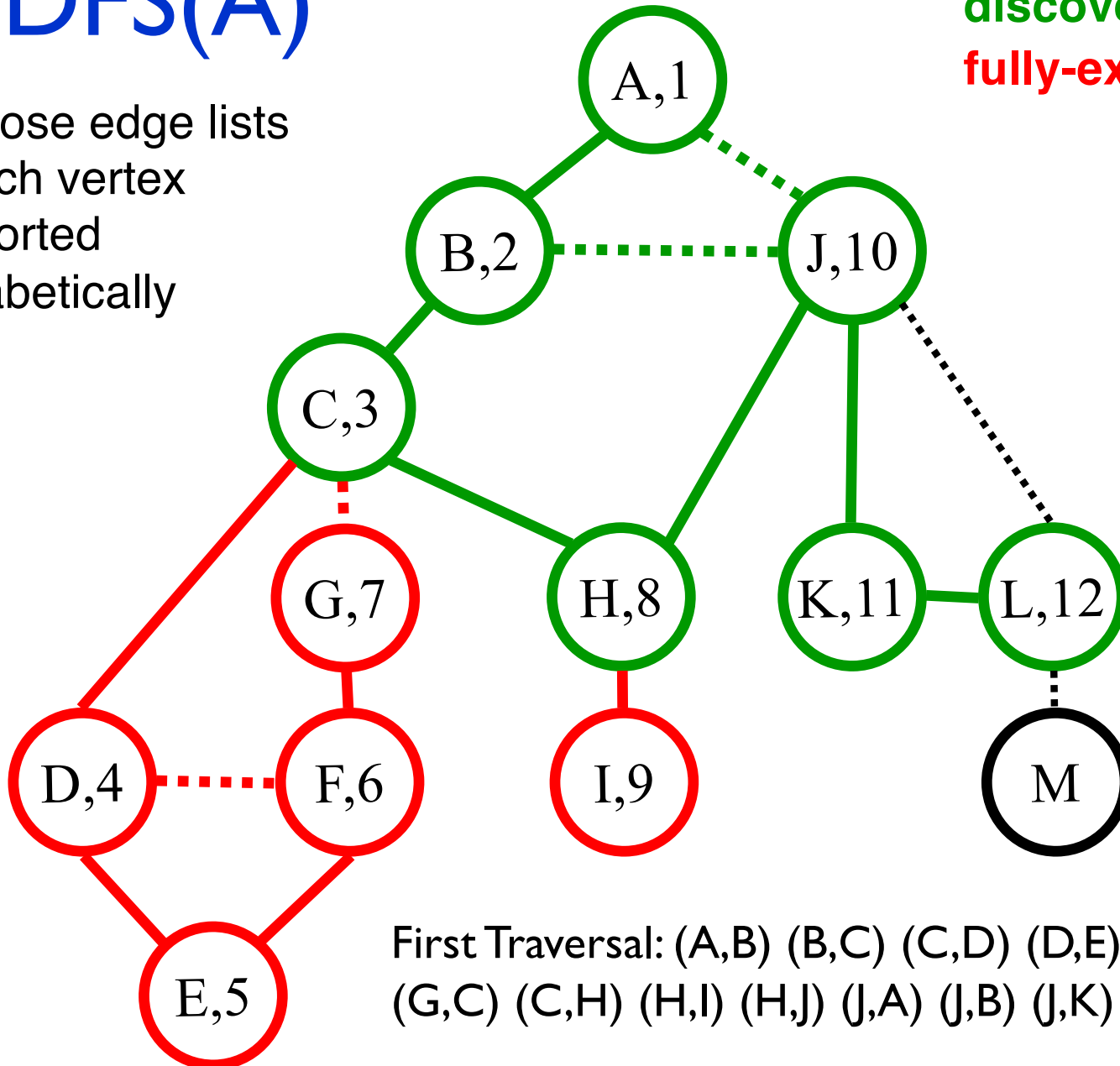

Call Stack: (Edge list)
A (B ,J)
B (A , C ,J)
C (B , D , G ,H)
H (C ,I,J)
J (A , B ,H, K ,L)
K (J , L)
L (J,K,M)

First Traversal: (A,B) (B,C) (C,D) (D,E) (E,F) (F,D) (F,G)
 (G,C) (C,H) (H,I) (H,J) (J,A) (J,B) (J,K) (K,L)

DFS(A)

Suppose edge lists at each vertex are sorted alphabetically

Color code:
 undiscovered
 discovered
 fully-explored

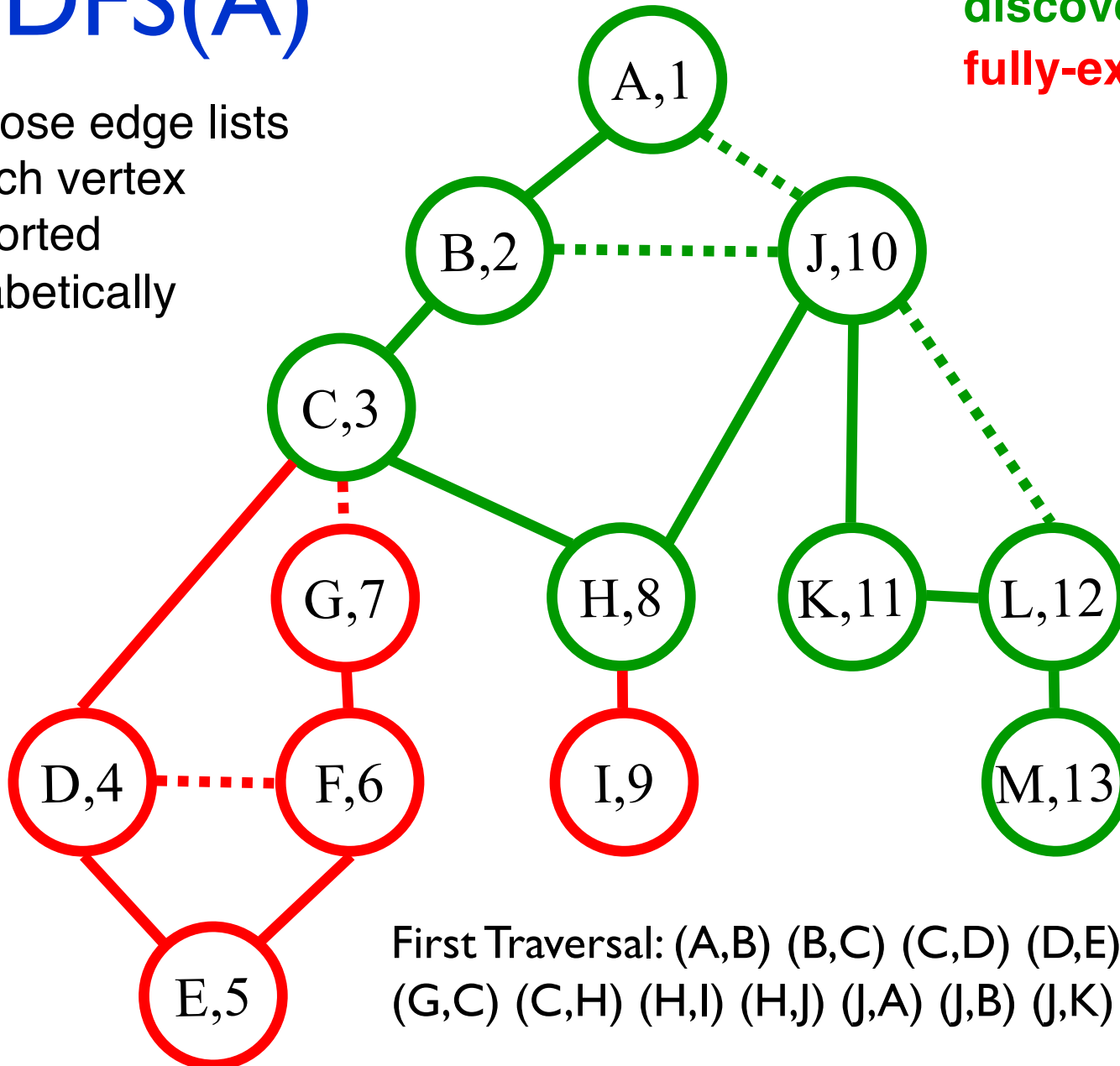

Call Stack: (Edge list)
A (B ,J)
B (A , C ,J)
C (B , D , G ,H)
H (C ,I,J)
J (A , B ,H, K ,L)
K (J ,L)
L (J , K ,M)
M(L)

First Traversal: (A,B) (B,C) (C,D) (D,E) (E,F) (F,D) (F,G)
 (G,C) (C,H) (H,I) (H,J) (J,A) (J,B) (J,K) (K,L) (L,J) (L,M)

DFS(A)

Suppose edge lists at each vertex are sorted alphabetically

Color code:
 undiscovered
 discovered
 fully-explored

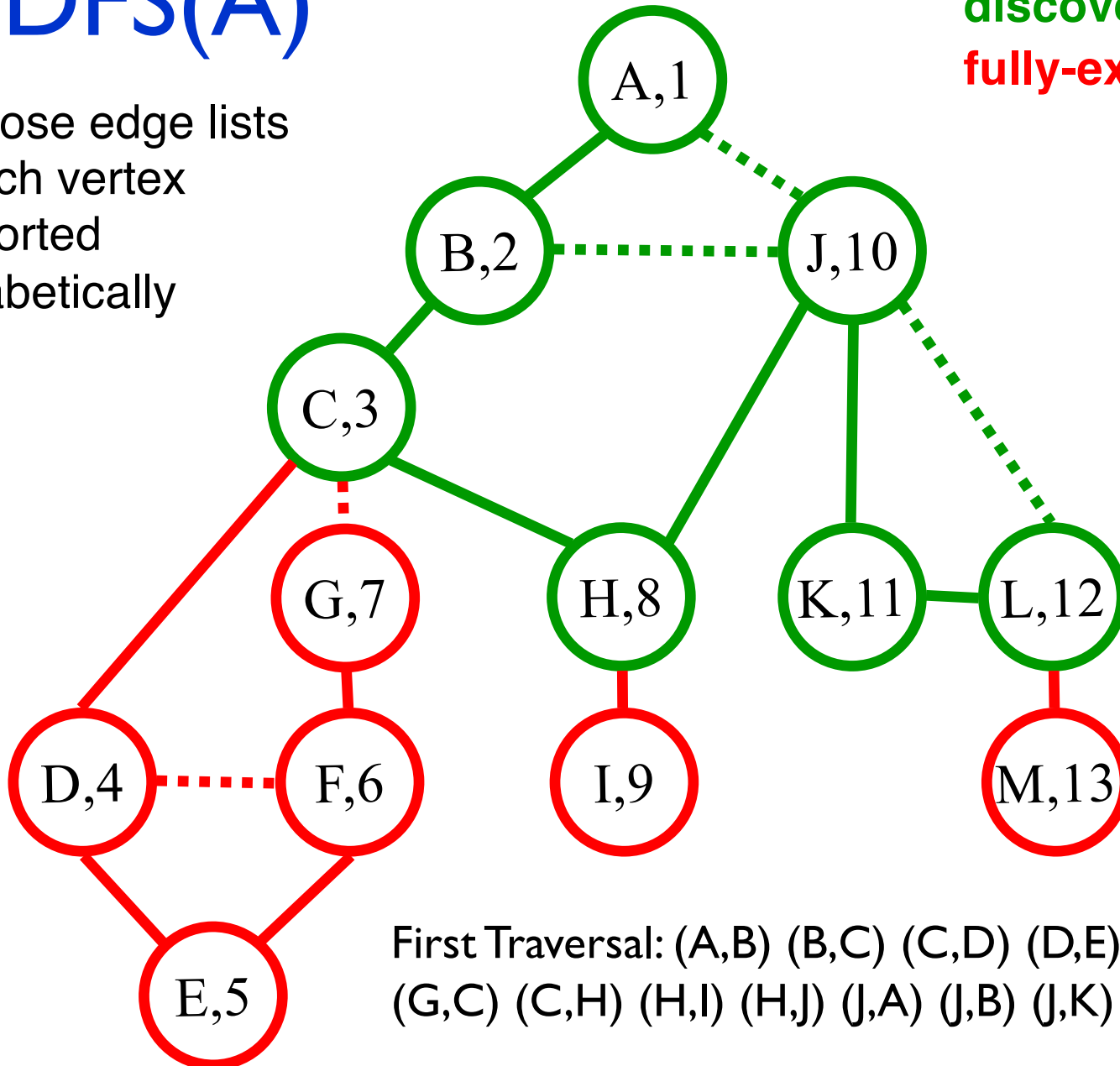

Call Stack: (Edge list)
A (B ,J)
B (A , C ,J)
C (B , D , G , H)
H (C , I ,J)
J (A , B , H , K ,L)
K (J ,L)
L (J , K , M)

First Traversal: (A,B) (B,C) (C,D) (D,E) (E,F) (F,D) (F,G)
 (G,C) (C,H) (H,I) (H,J) (J,A) (J,B) (J,K) (K,L) (L,J) (L,M)

DFS(A)

Suppose edge lists at each vertex are sorted alphabetically

Color code:
 undiscovered
 discovered
 fully-explored

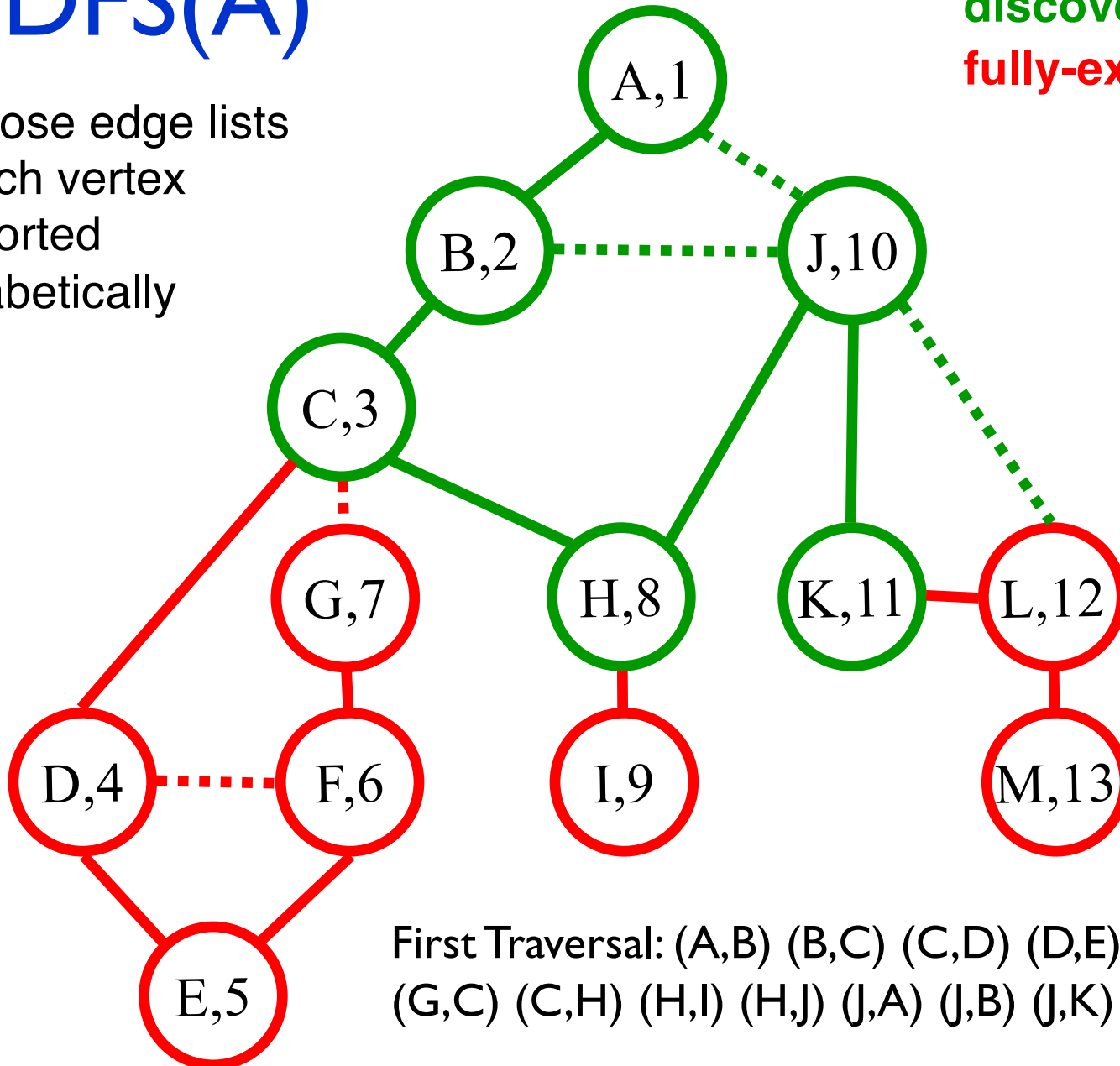

Call Stack: (Edge list)
A (B ,J)
B (A , C ,J)
C (B , D , G , H)
H (C , I ,J)
J (A , B , H , K ,L)
K (J , L)

First Traversal: (A,B) (B,C) (C,D) (D,E) (E,F) (F,D) (F,G)
 (G,C) (C,H) (H,I) (H,J) (J,A) (J,B) (J,K) (K,L) (L,J) (L,M)

DFS(A)

Suppose edge lists at each vertex are sorted alphabetically

Color code:
 undiscovered
 discovered
 fully-explored

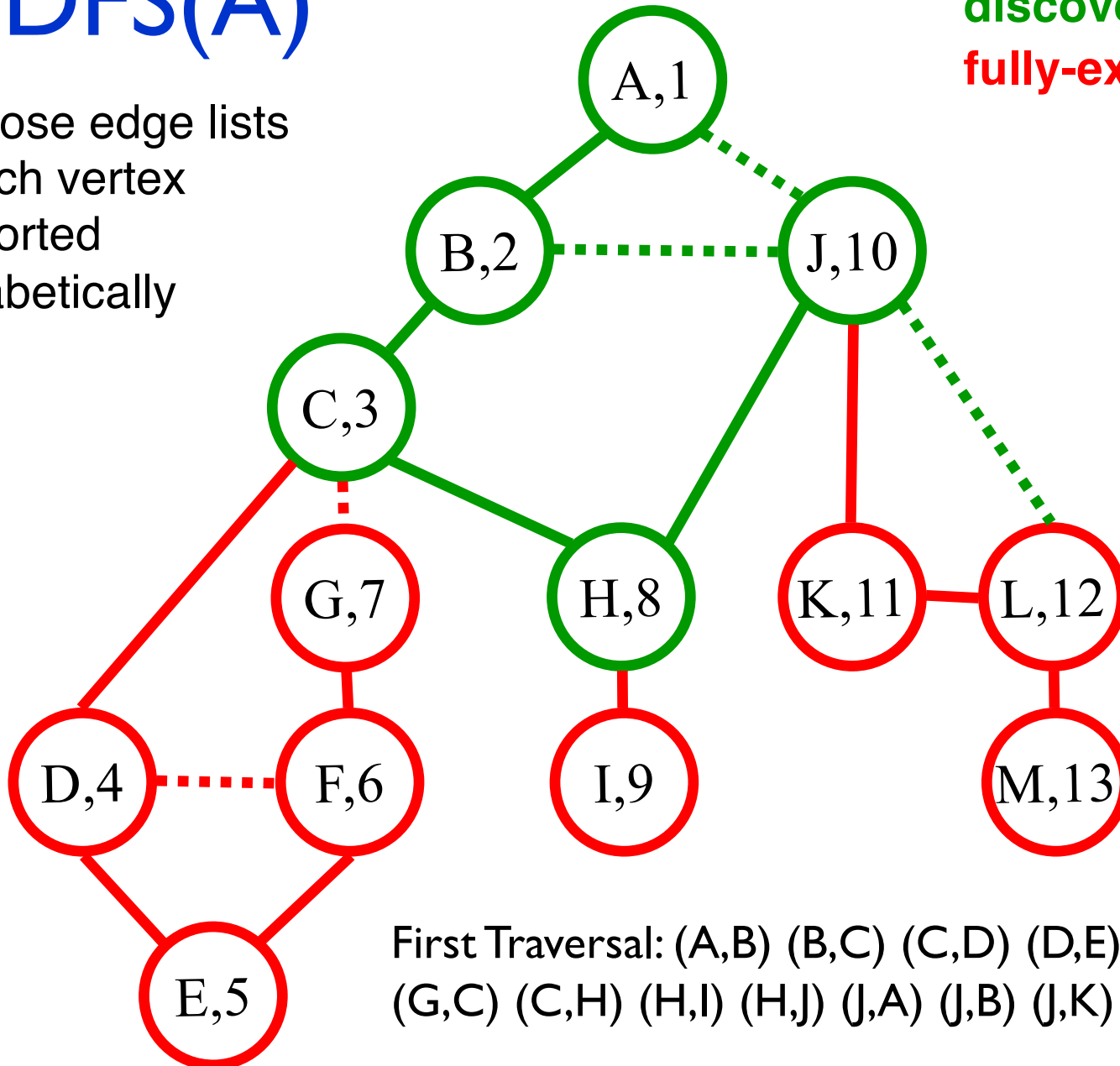

Call Stack: (Edge list)
A (B ,J)
B (A , C ,J)
C (B , D , G , H)
H (C , I ,J)
J (A , B , H , K ,L)

First Traversal: (A,B) (B,C) (C,D) (D,E) (E,F) (F,D) (F,G)
 (G,C) (C,H) (H,I) (H,J) (J,A) (J,B) (J,K) (K,L) (L,J) (L,M)

DFS(A)

Suppose edge lists at each vertex are sorted alphabetically

Color code:
 undiscovered
 discovered
 fully-explored

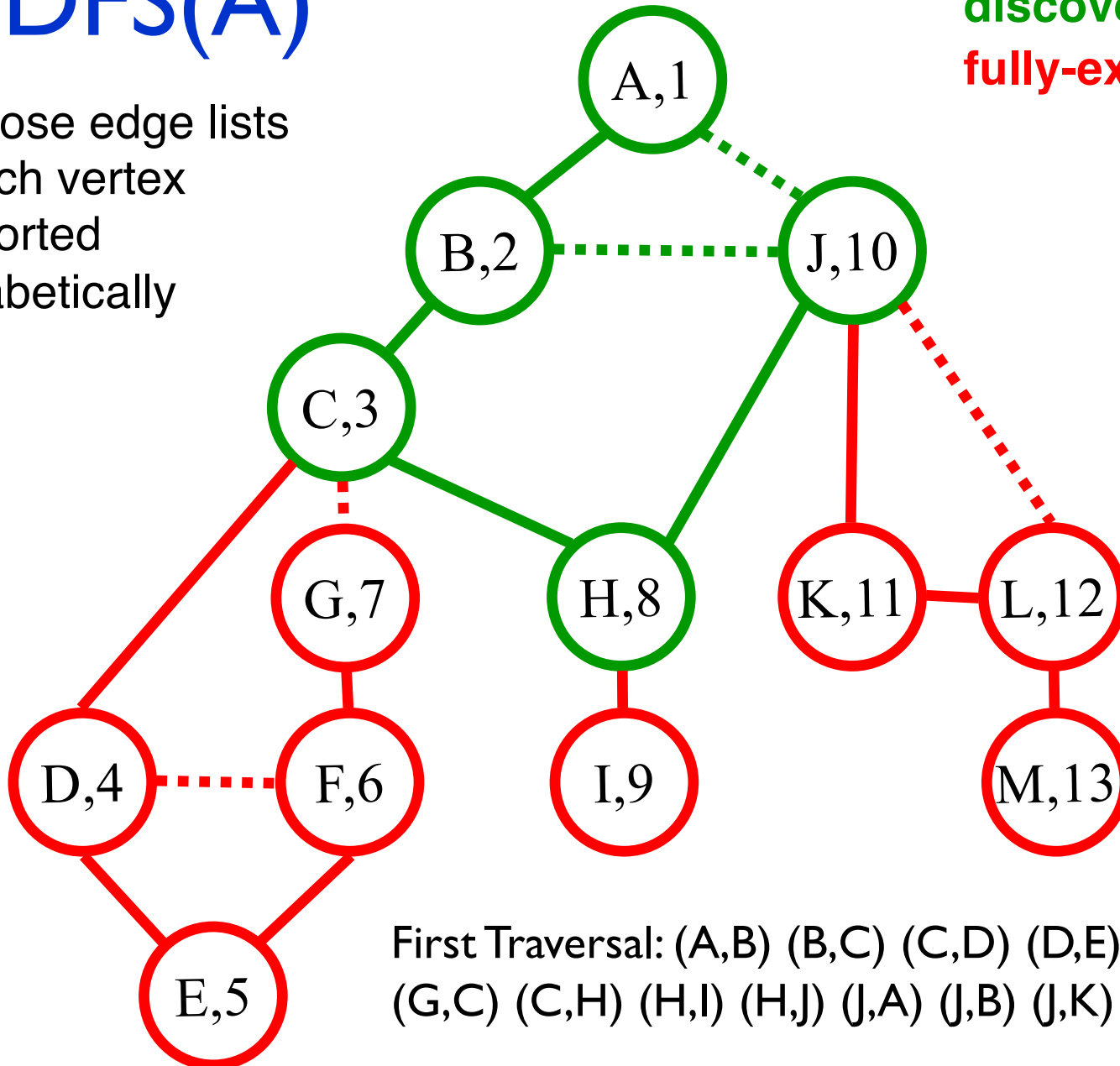

Call Stack: (Edge list)
A (B ,J)
B (A , C ,J)
C (B , D , G ,H)
H (C ,I,J)
J (A , B , H , K ,L)

First Traversal: (A,B) (B,C) (C,D) (D,E) (E,F) (F,D) (F,G)
 (G,C) (C,H) (H,I) (H,J) (J,A) (J,B) (J,K) (K,L) (L,J) (L,M)

DFS(A)

Suppose edge lists at each vertex are sorted alphabetically

Color code:
undiscovered
discovered
fully-explored

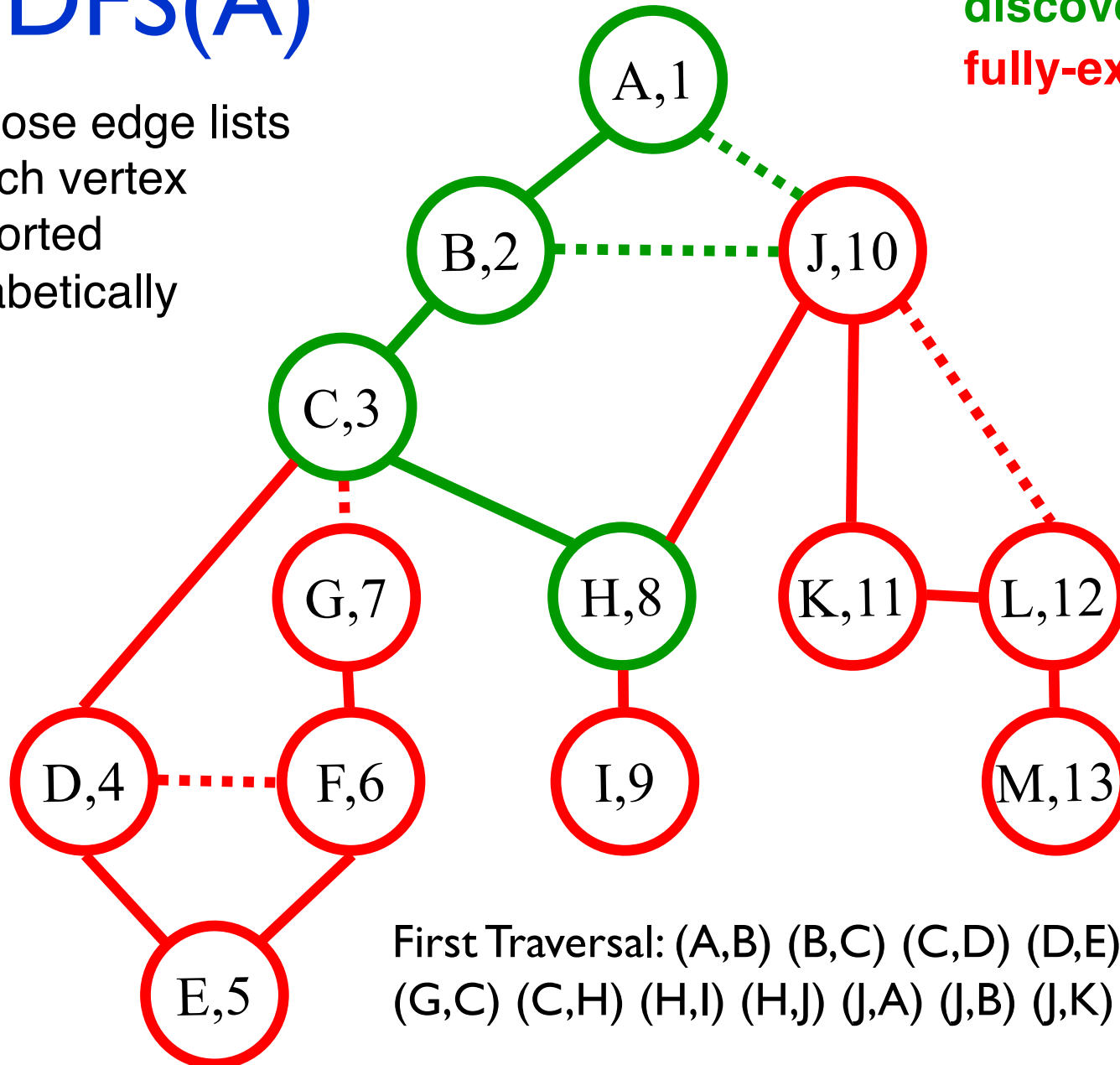

Call Stack: (Edge list)
A (B ,J)
B (A , C ,J)
C (B , D , G , H)
H (C , I ,J)

First Traversal: (A,B) (B,C) (C,D) (D,E) (E,F) (F,D) (F,G)
(G,C) (C,H) (H,I) (H,J) (J,A) (J,B) (J,K) (K,L) (L,J) (L,M)

DFS(A)

Suppose edge lists at each vertex are sorted alphabetically

Color code:
 undiscovered
 discovered
 fully-explored

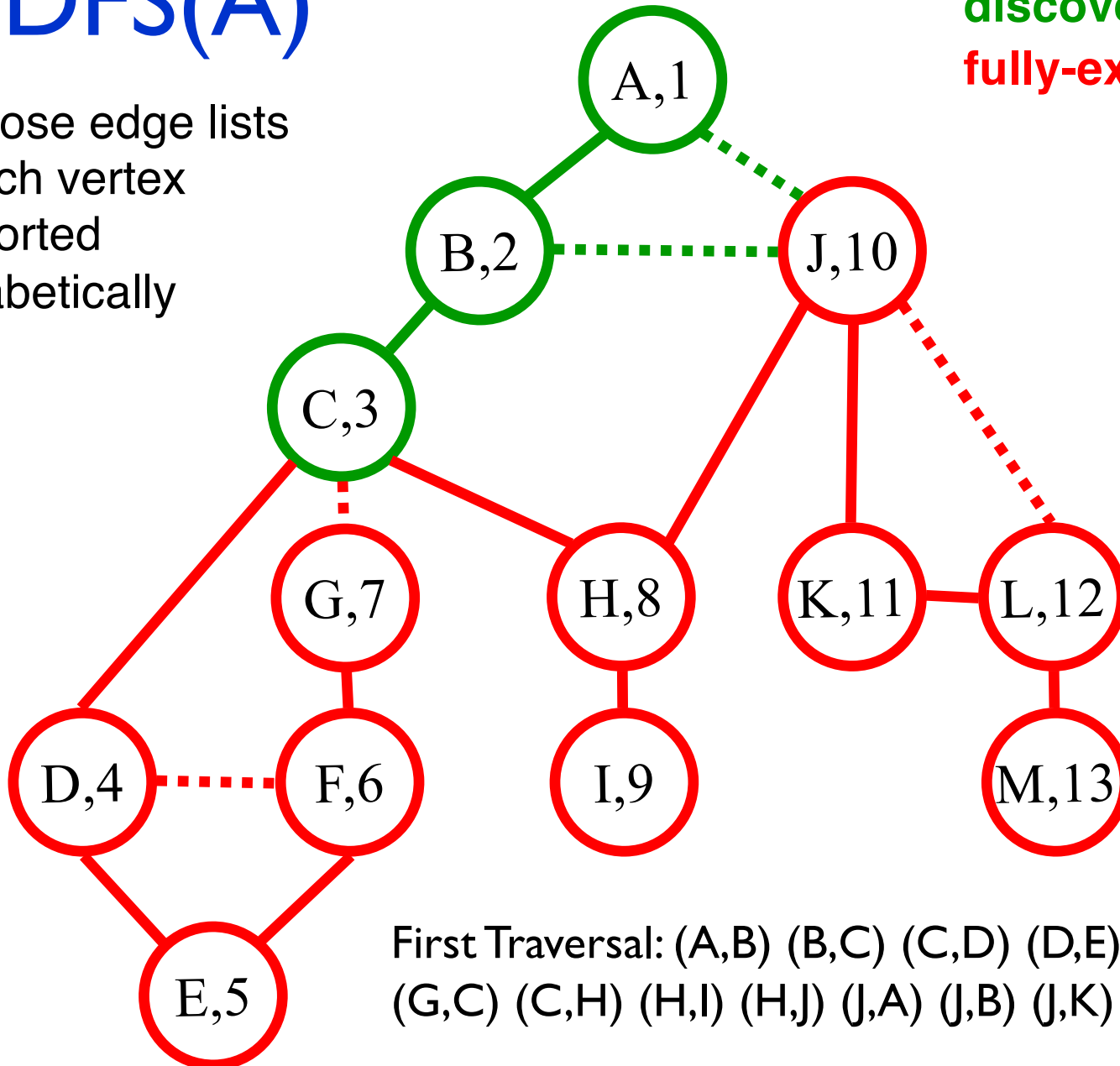

Call Stack: (Edge list)
A (B ,J)
B (A , C ,J)
C (B , D , G ,H)

First Traversal: (A,B) (B,C) (C,D) (D,E) (E,F) (F,D) (F,G)
 (G,C) (C,H) (H,I) (H,J) (J,A) (J,B) (J,K) (K,L) (L,J) (L,M)

DFS(A)

Suppose edge lists at each vertex are sorted alphabetically

Color code:
undiscovered
discovered
fully-explored

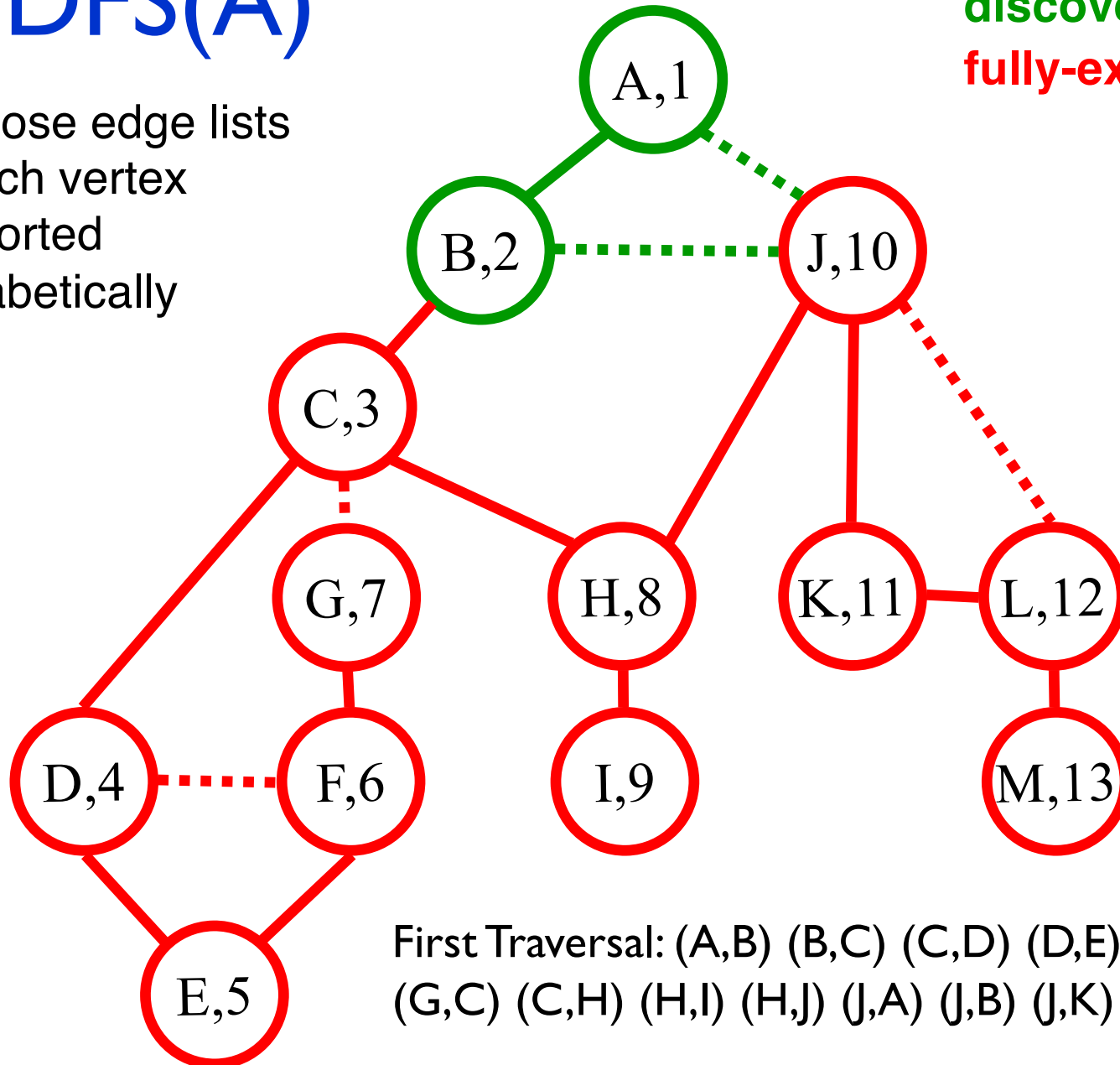

Call Stack: (Edge list)
A (B ,J)
B (A , C ,J)

First Traversal: (A,B) (B,C) (C,D) (D,E) (E,F) (F,D) (F,G)
(G,C) (C,H) (H,I) (H,J) (J,A) (J,B) (J,K) (K,L) (L,J) (L,M)

DFS(A)

Suppose edge lists at each vertex are sorted alphabetically

Color code:
 undiscovered
 discovered
 fully-explored

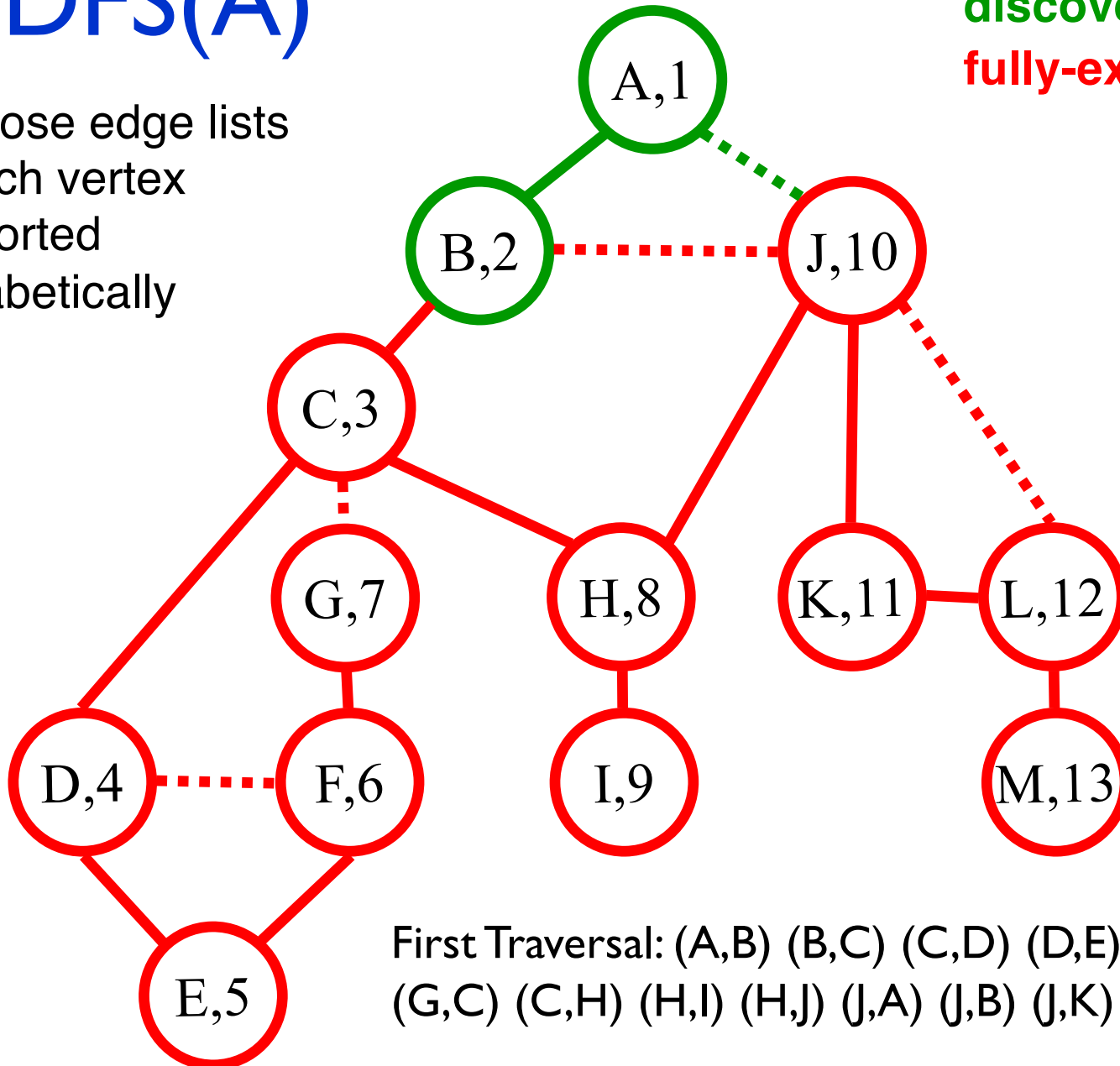

Call Stack: (Edge list)
A (B ,J)
B (A , C , J)

First Traversal: (A,B) (B,C) (C,D) (D,E) (E,F) (F,D) (F,G)
 (G,C) (C,H) (H,I) (H,J) (J,A) (J,B) (J,K) (K,L) (L,J) (L,M)

DFS(A)

Suppose edge lists at each vertex are sorted alphabetically

Color code:
undiscovered
discovered
fully-explored

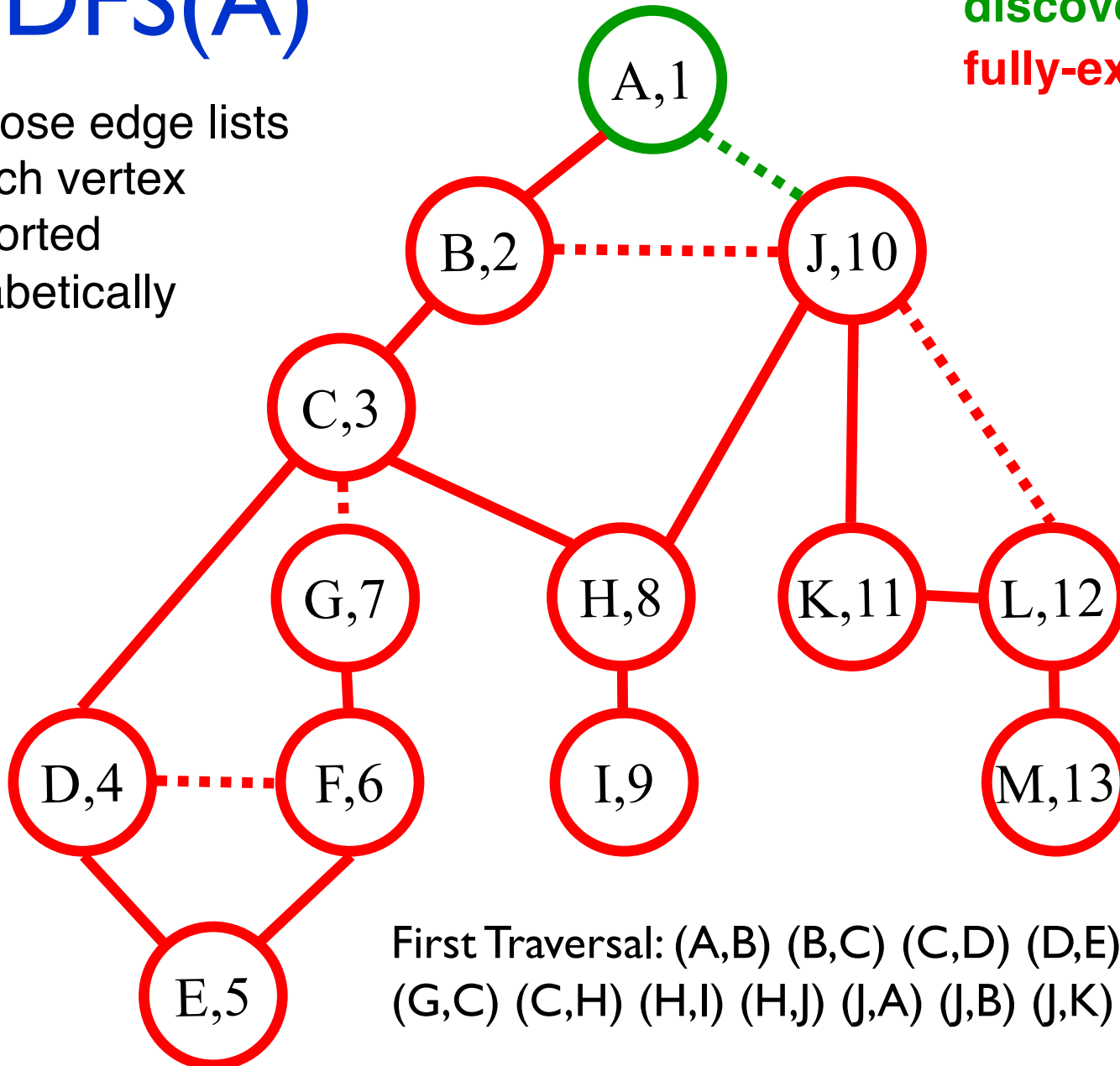

Call Stack: (Edge list)
A (B ,J)

First Traversal: (A,B) (B,C) (C,D) (D,E) (E,F) (F,D) (F,G)
(G,C) (C,H) (H,I) (H,J) (J,A) (J,B) (J,K) (K,L) (L,J) (L,M)

DFS(A)

Suppose edge lists at each vertex are sorted alphabetically

Color code:
undiscovered
discovered
fully-explored

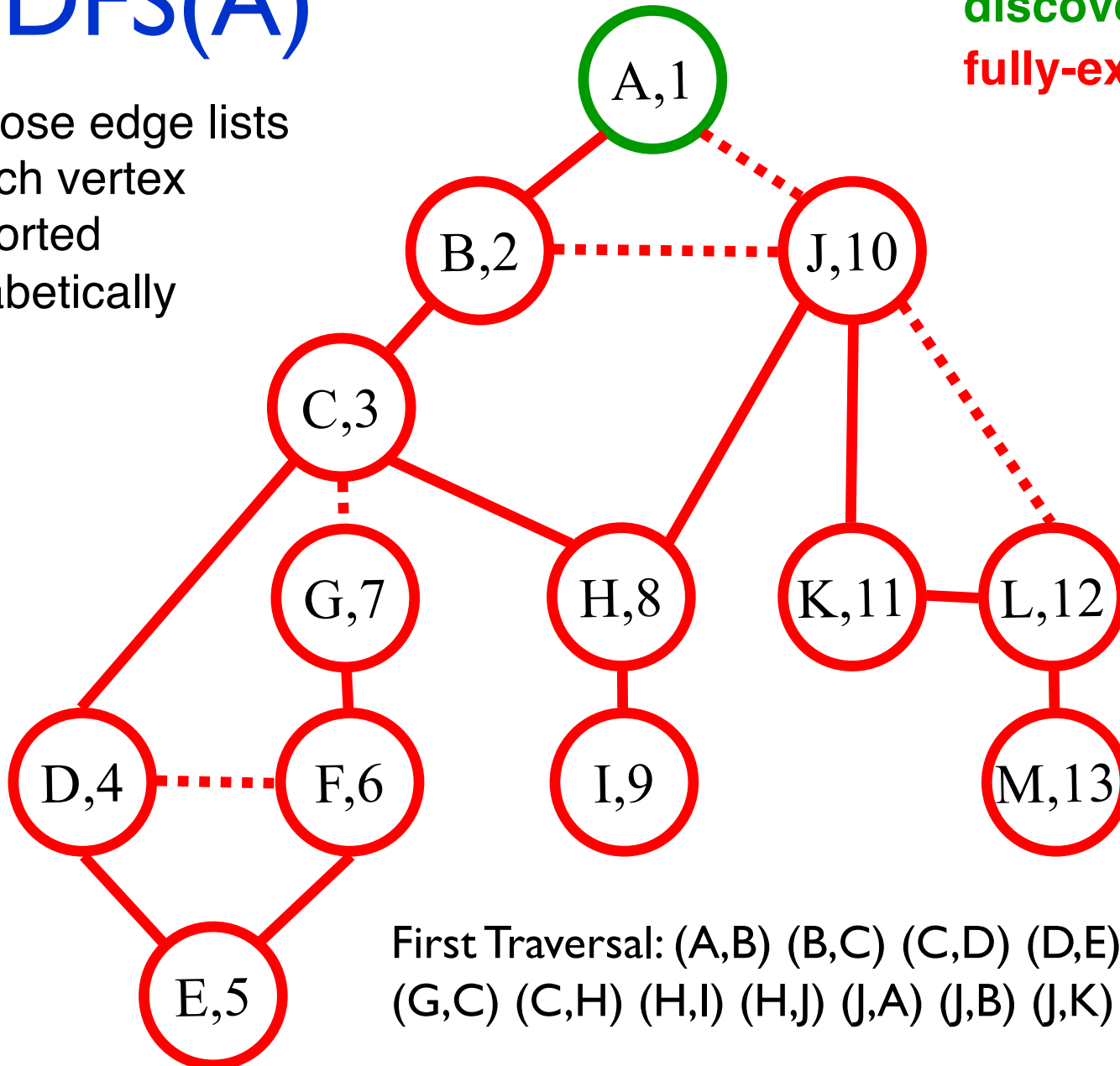

Call Stack: (Edge list)
A (B , J)

First Traversal: (A,B) (B,C) (C,D) (D,E) (E,F) (F,D) (F,G)
(G,C) (C,H) (H,I) (H,J) (J,A) (J,B) (J,K) (K,L) (L,J) (L,M)

DFS(A)

Suppose edge lists at each vertex are sorted alphabetically

Color code:
undiscovered
discovered
fully-explored

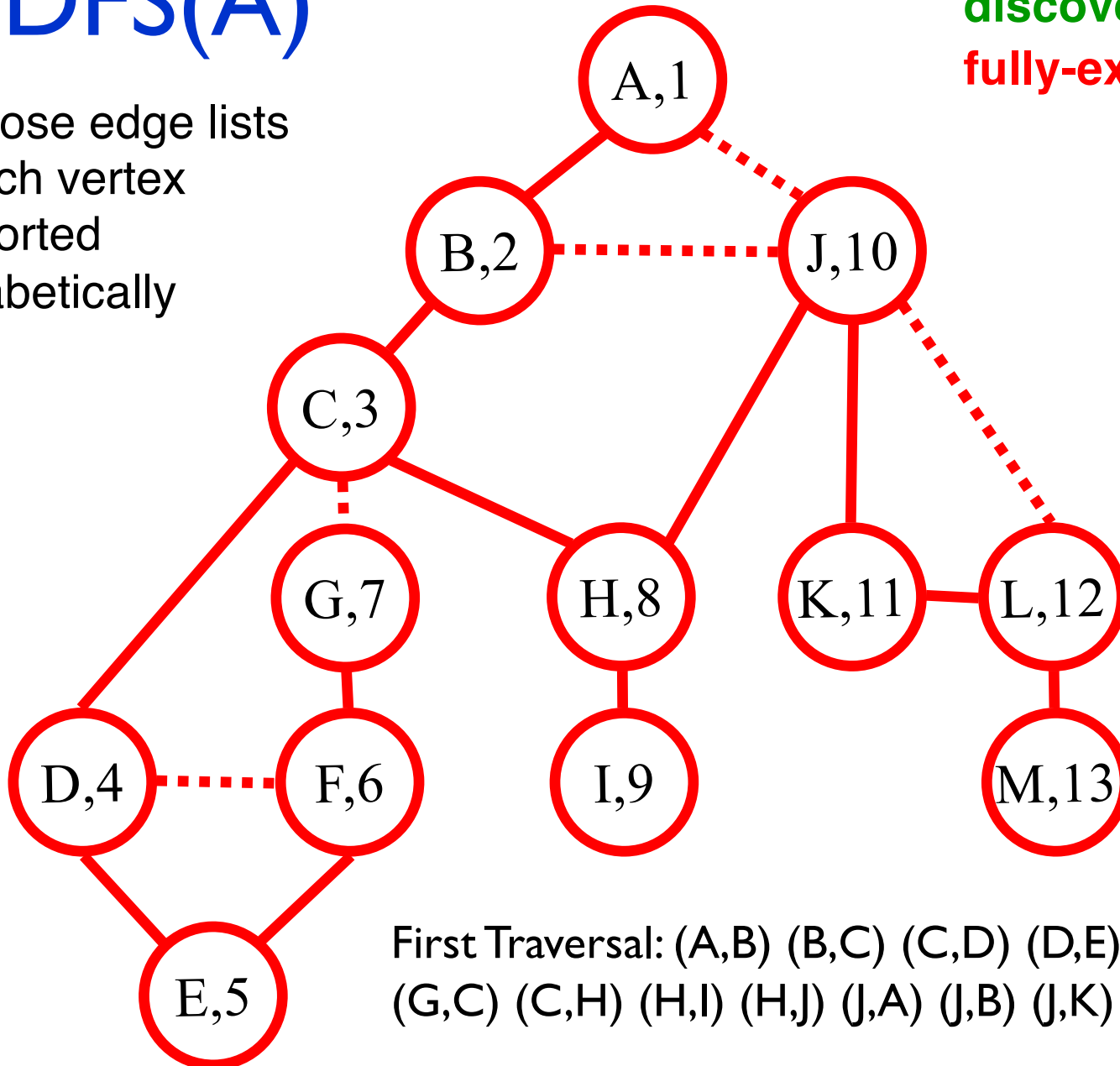

Call Stack: (Edge list)
TA-DA!!

First Traversal: (A,B) (B,C) (C,D) (D,E) (E,F) (F,D) (F,G)
(G,C) (C,H) (H,I) (H,J) (J,A) (J,B) (J,K) (K,L) (L,J) (L,M)

DFS(A)

Edge code:

Tree edge



Back edge

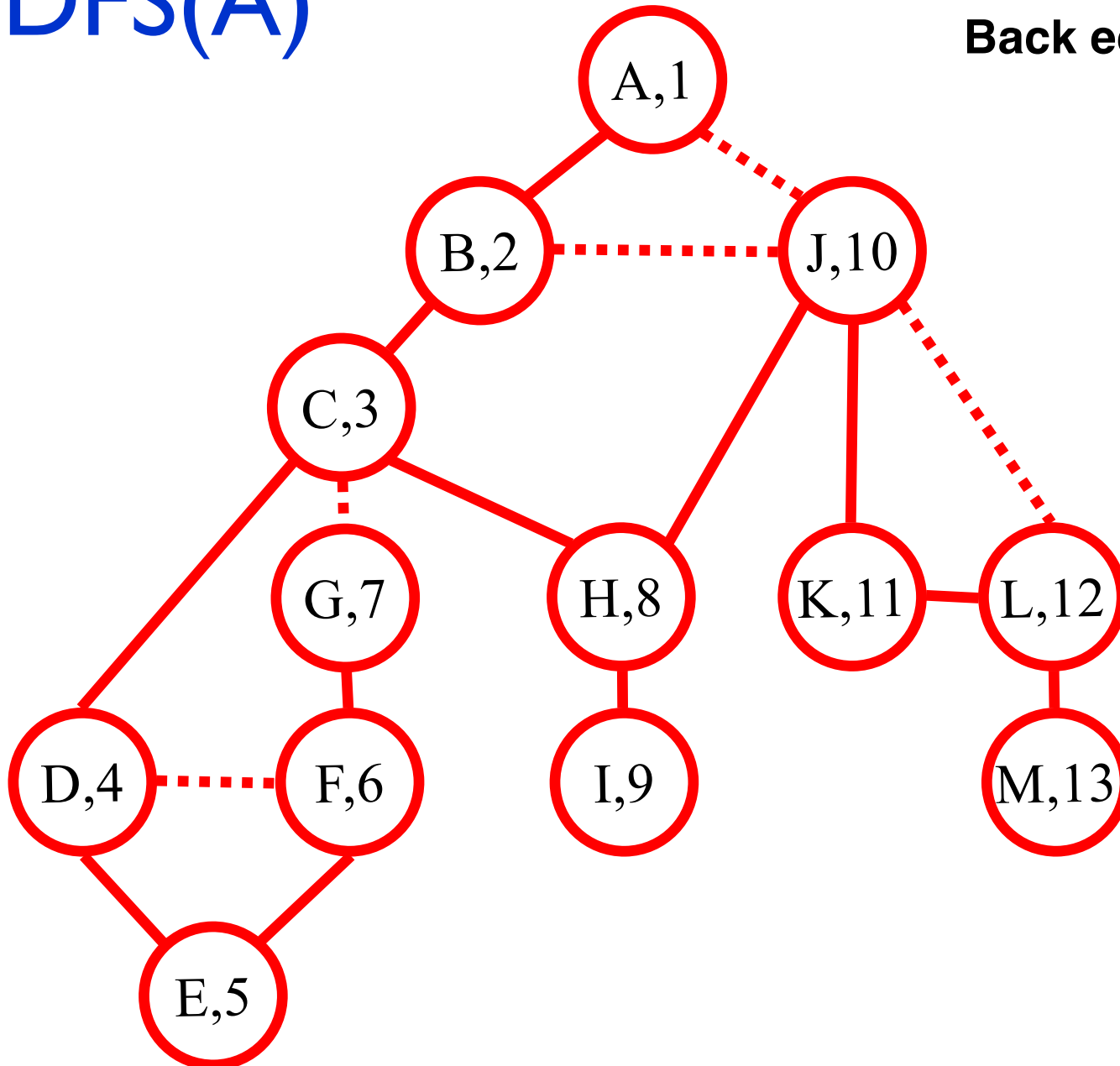

DFS(A)

Edge code:

Tree edge



Back edge

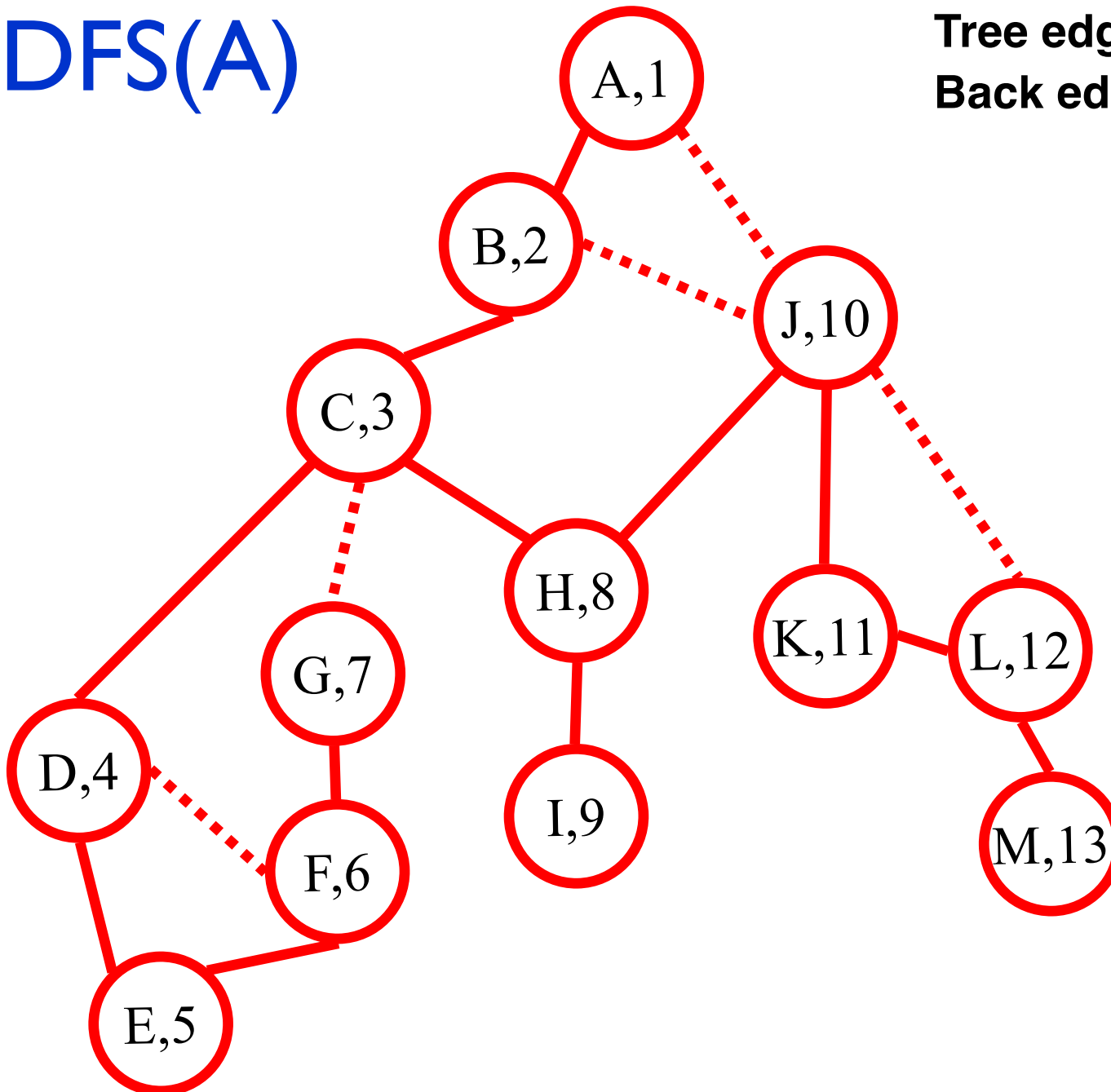

DFS(A)

Edge code:

Tree edge



Back edge

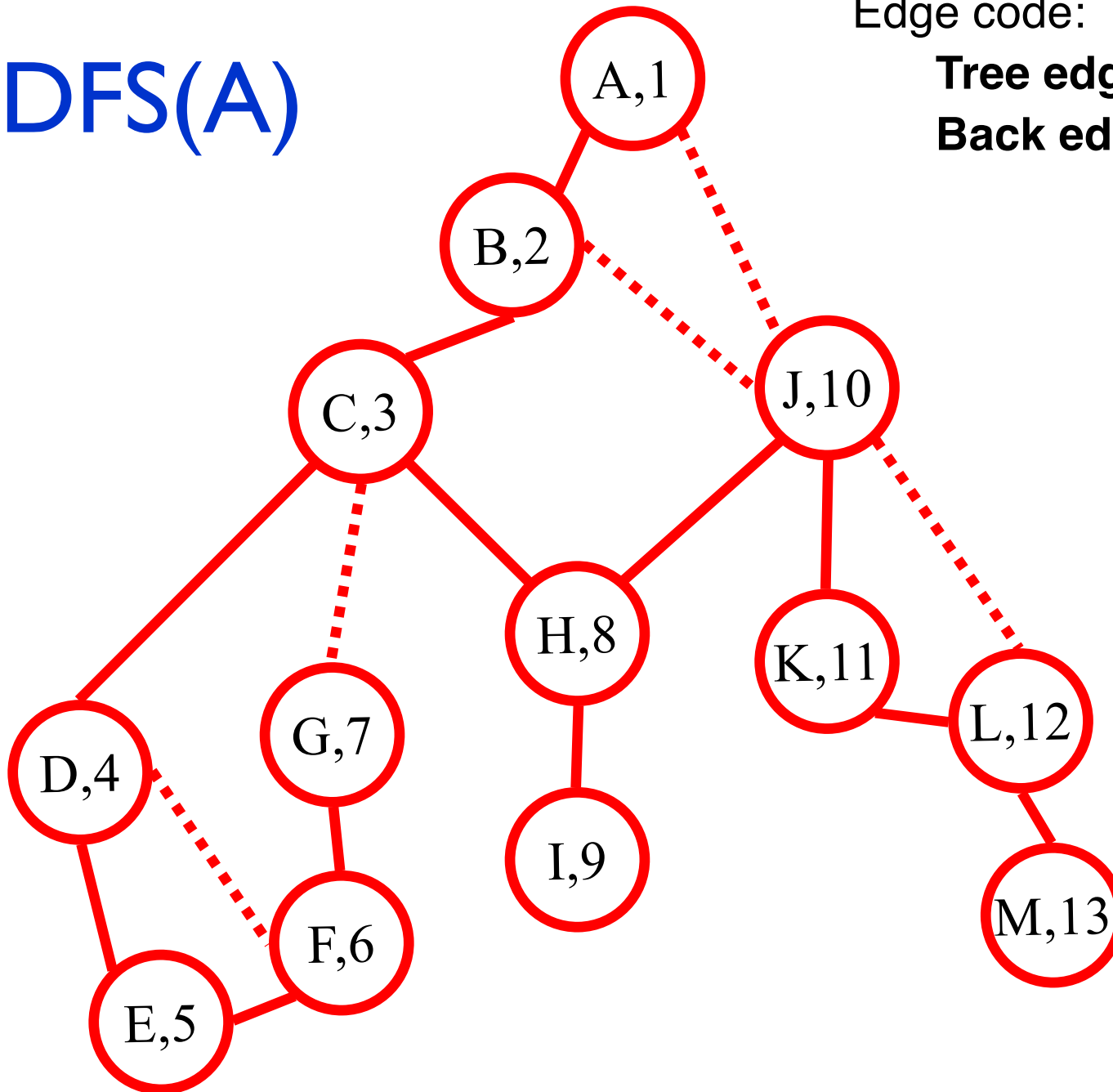

DFS(A)

Edge code:

Tree edge

Back edge

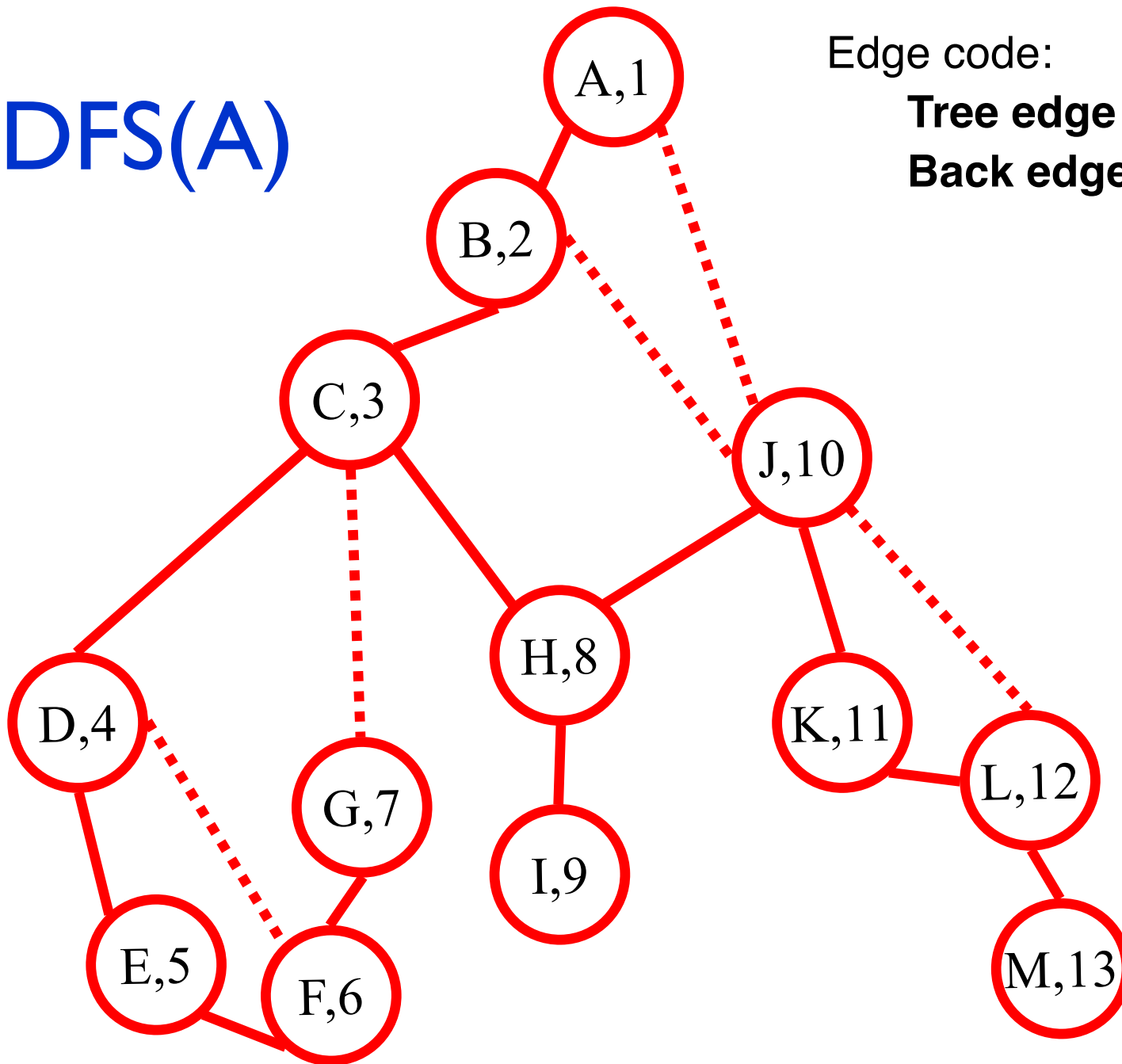

DFS(A)

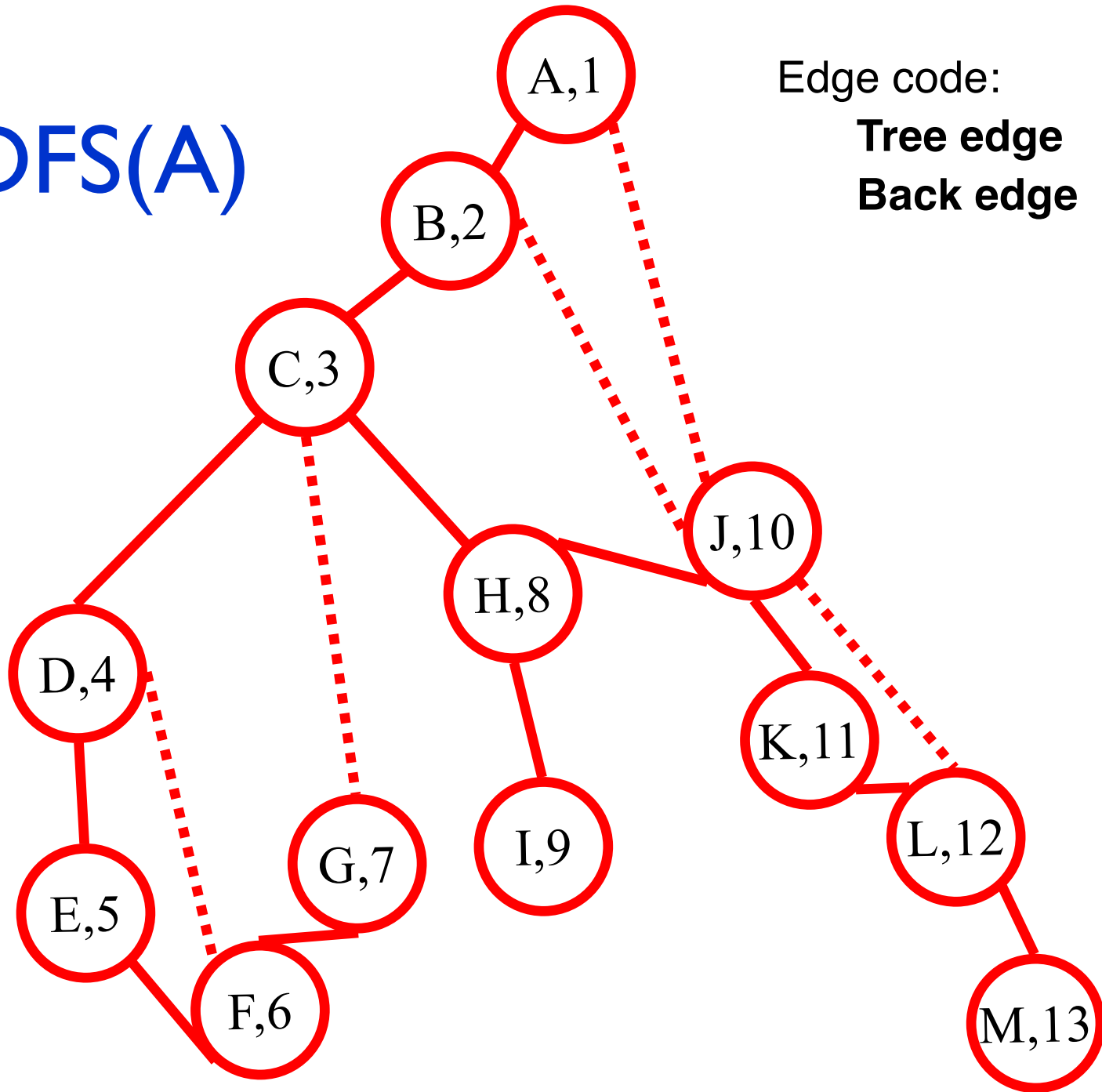

Edge code:

Tree edge



Back edge



DFS(A)

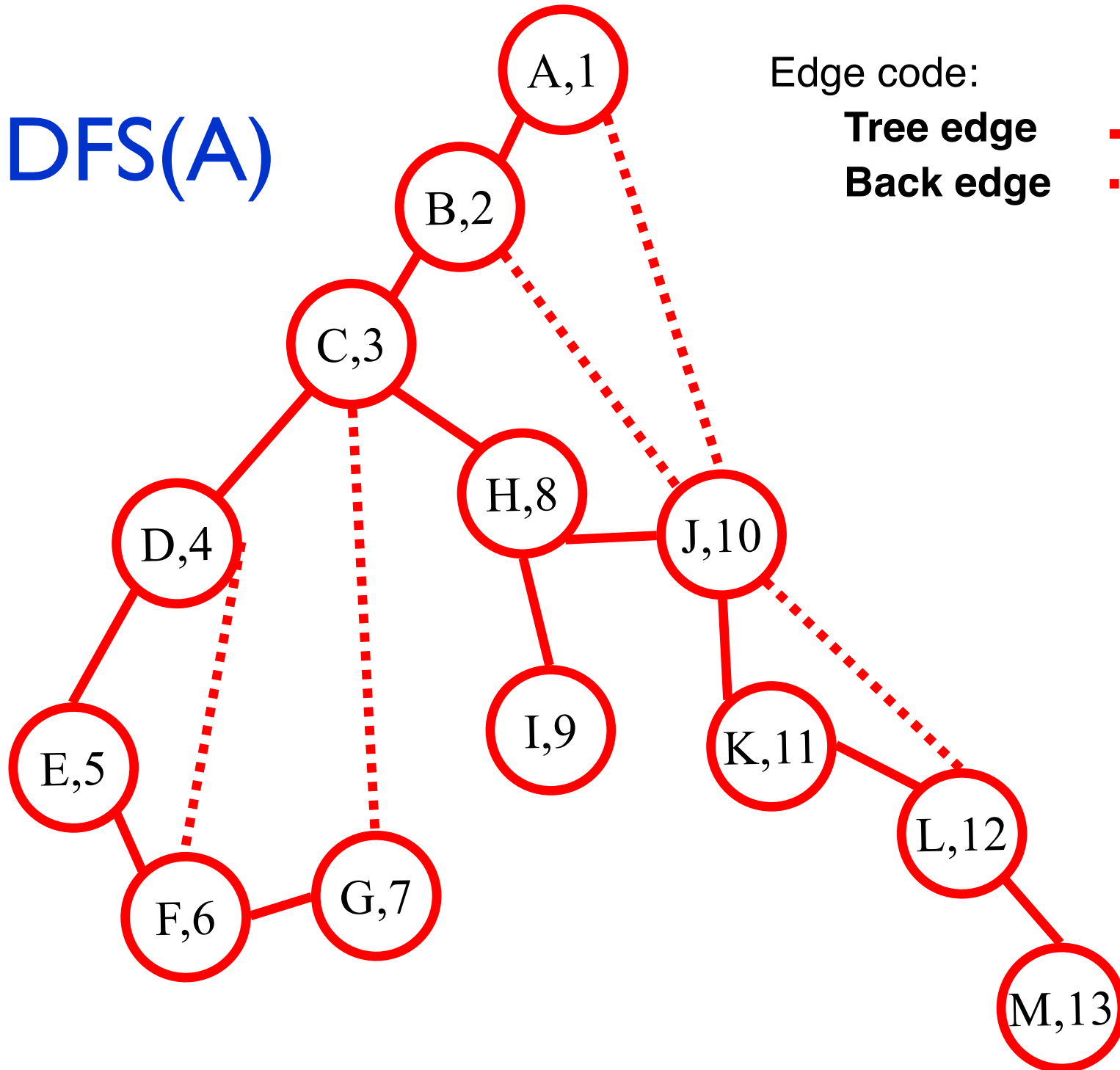

DFS(A)

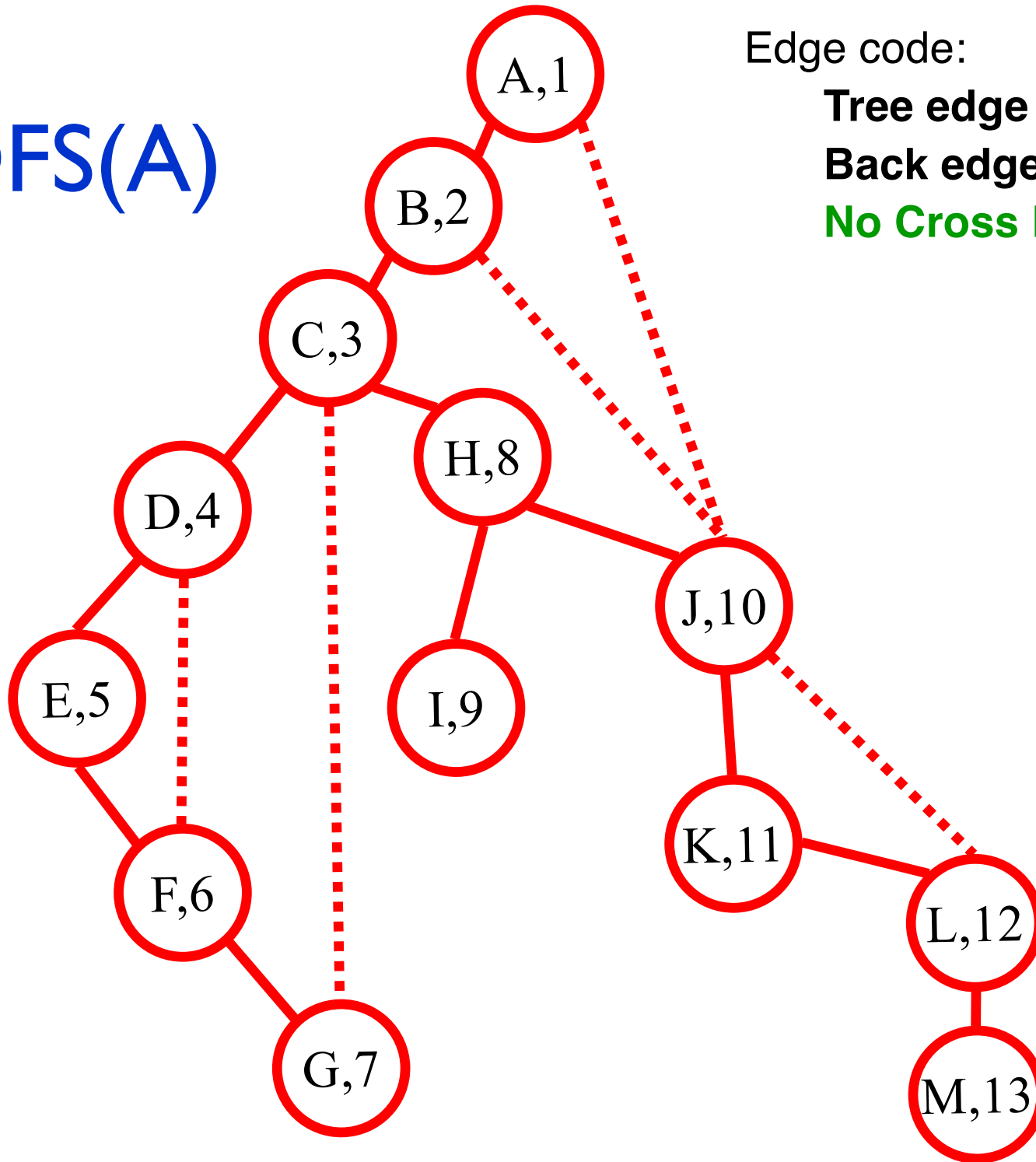

Edge code:

Tree edge 

Back edge 

No Cross Edges!

Properties of (Undirected) DFS(v)

Like BFS(v):

DFS(v) visits x if and only if there is a path in G from v to x (through previously unvisited vertices)

Edges into then-undiscovered vertices define a **tree** – the "depth first spanning tree" of G

Unlike the BFS tree:

the DF spanning tree isn't minimum depth

its levels don't reflect min distance from the root

non-tree edges *never* join vertices on the same or adjacent levels

BUT...

Non-tree edges

All non-tree edges join a vertex and one of its descendants/ancestors in the DFS tree

No cross edges!

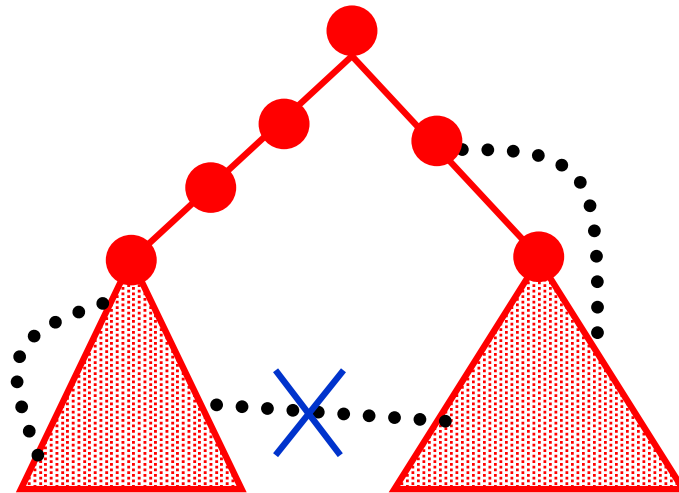

Why fuss about trees (again)?

As with BFS, DFS has found a tree in the graph s.t. non-tree edges are "simple" – only descendant/ancestor

A simple problem on trees

Given: tree T , a value $L(v)$ defined for every vertex v in T

Goal: find $M(v)$, the min value of $L(v)$ anywhere in the subtree rooted at v (including v itself).

How? Depth first search, using:

$$M(v) = \left. \begin{array}{l} L(v) \\ \min(L(v), \min_{w \text{ a child of } v} M(w)) \end{array} \right\} \begin{array}{l} \text{if } v \text{ is a leaf} \\ \text{otherwise} \end{array}$$

Application: Articulation Points

A node in an undirected graph is an *articulation point* iff removing it disconnects the graph (or, more generally, increases the number of connected components)

Articulation
(noun): the state
of being jointed

Articulation points represent, e.g.:

vulnerabilities in a network – single points whose failure would split the network into 2 or more disconnected components

bottlenecks to information flow in a network

...

Identifying key proteins on the anthrax predicted network

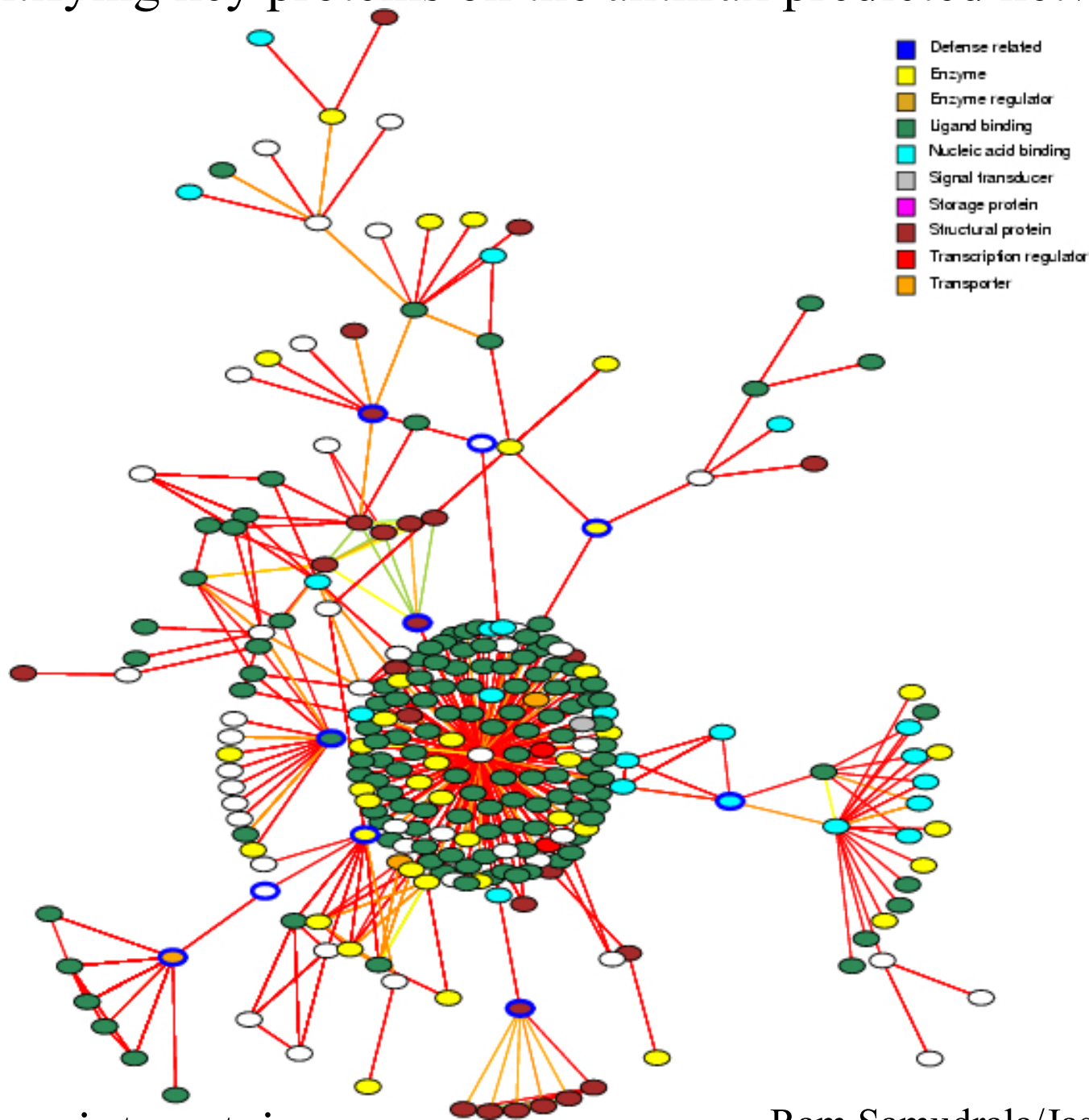

Articulation point proteins

Ram Samudrala/Jason McDermott

Articulation Points

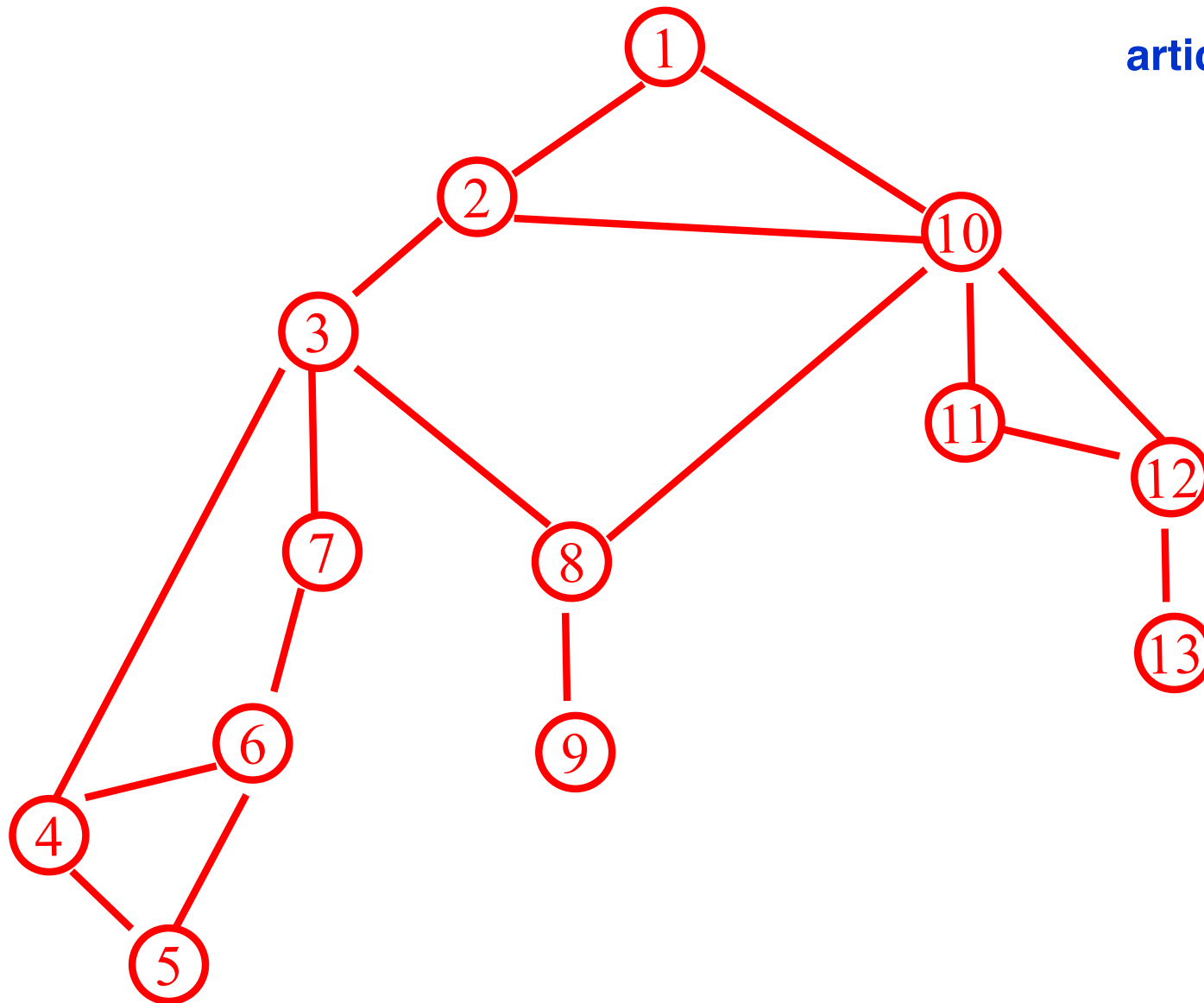

articulation point
iff its removal
disconnects
the graph

Articulation Points

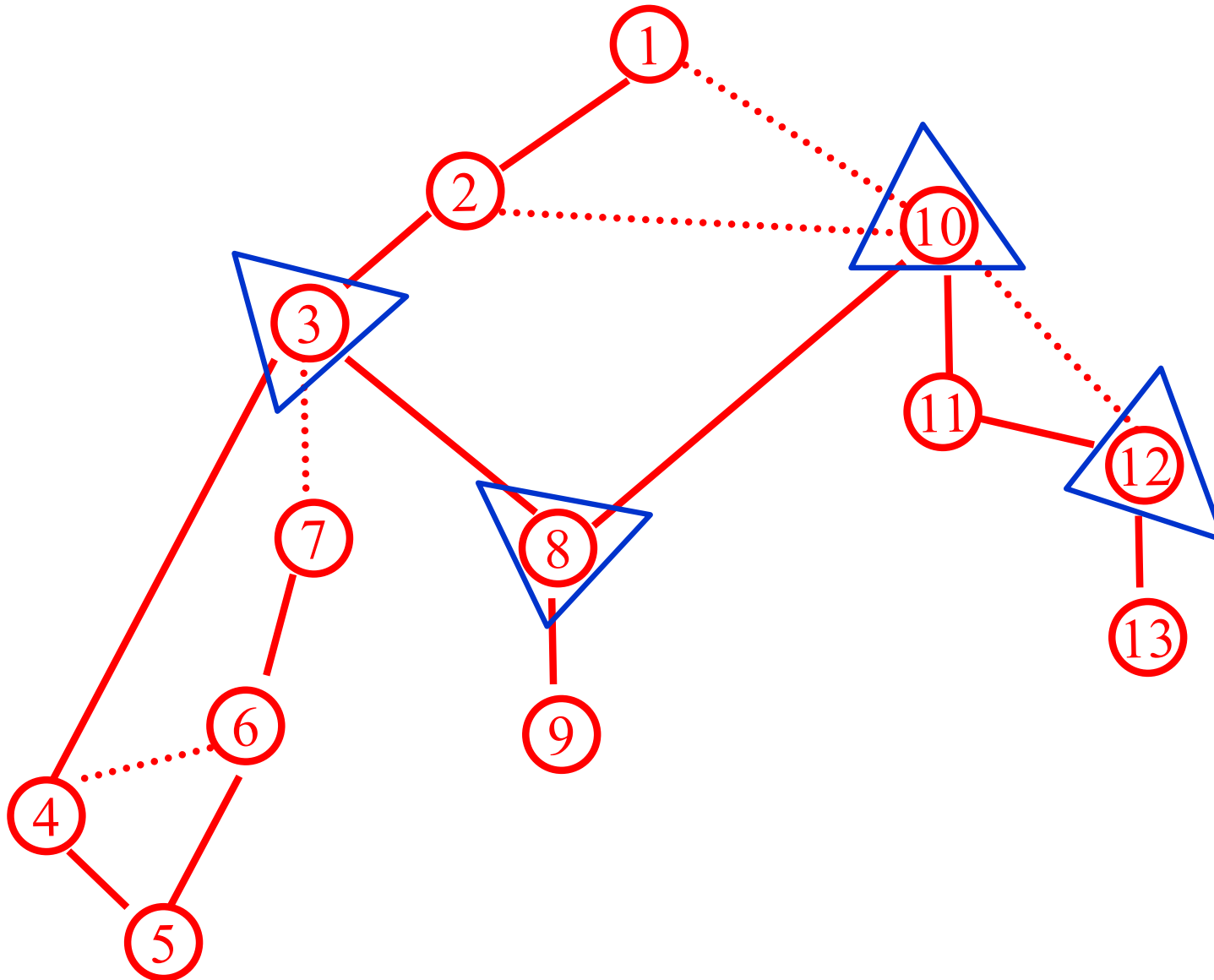

Simple Case: Artic. Pts in a tree

Leaves – never articulation points

Internal nodes – always articulation points

Root – articulation point if and only if it has two or more children

Non-tree: extra edges remove some articulation points (which ones?)

Articulation Points

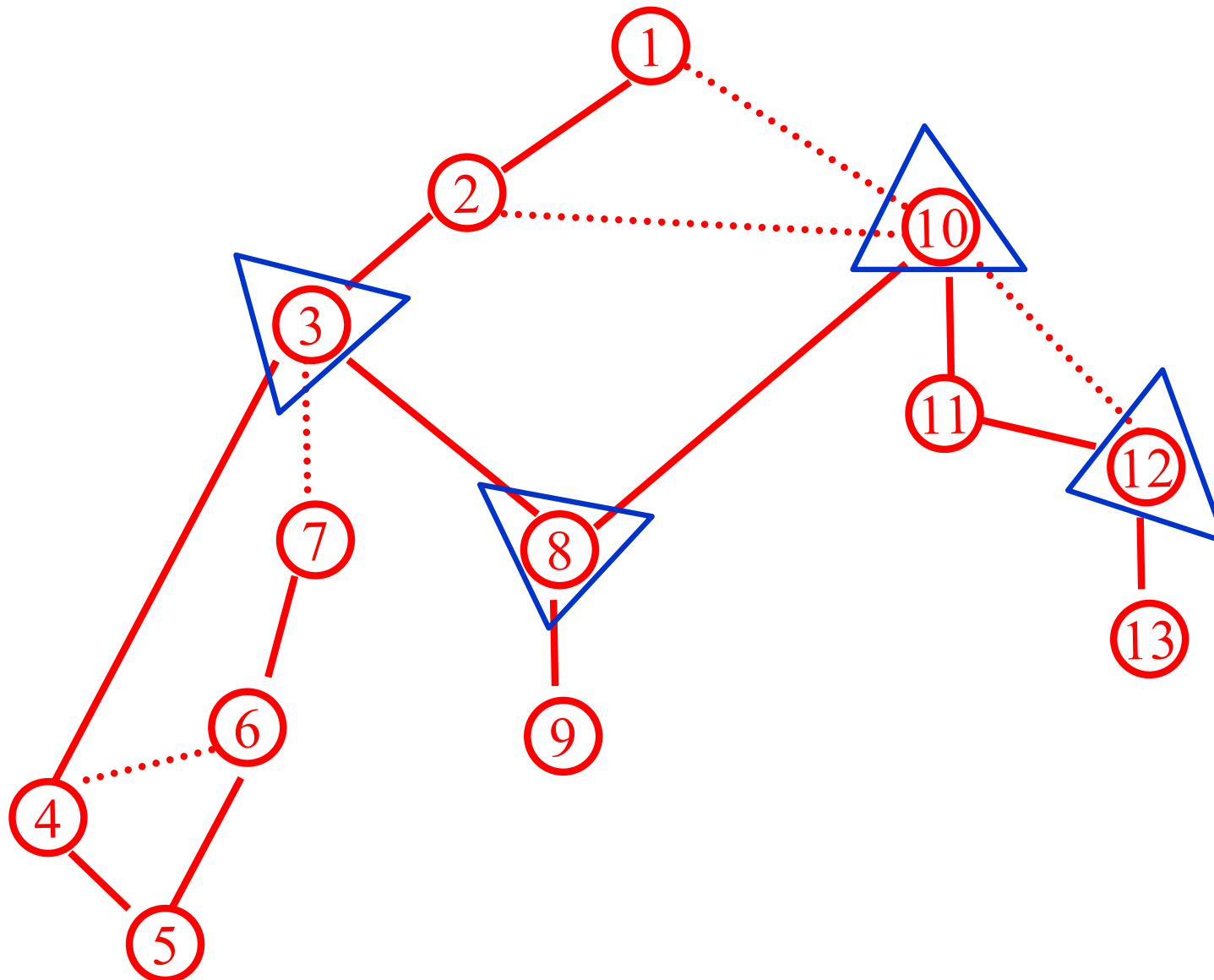

DFS(A)

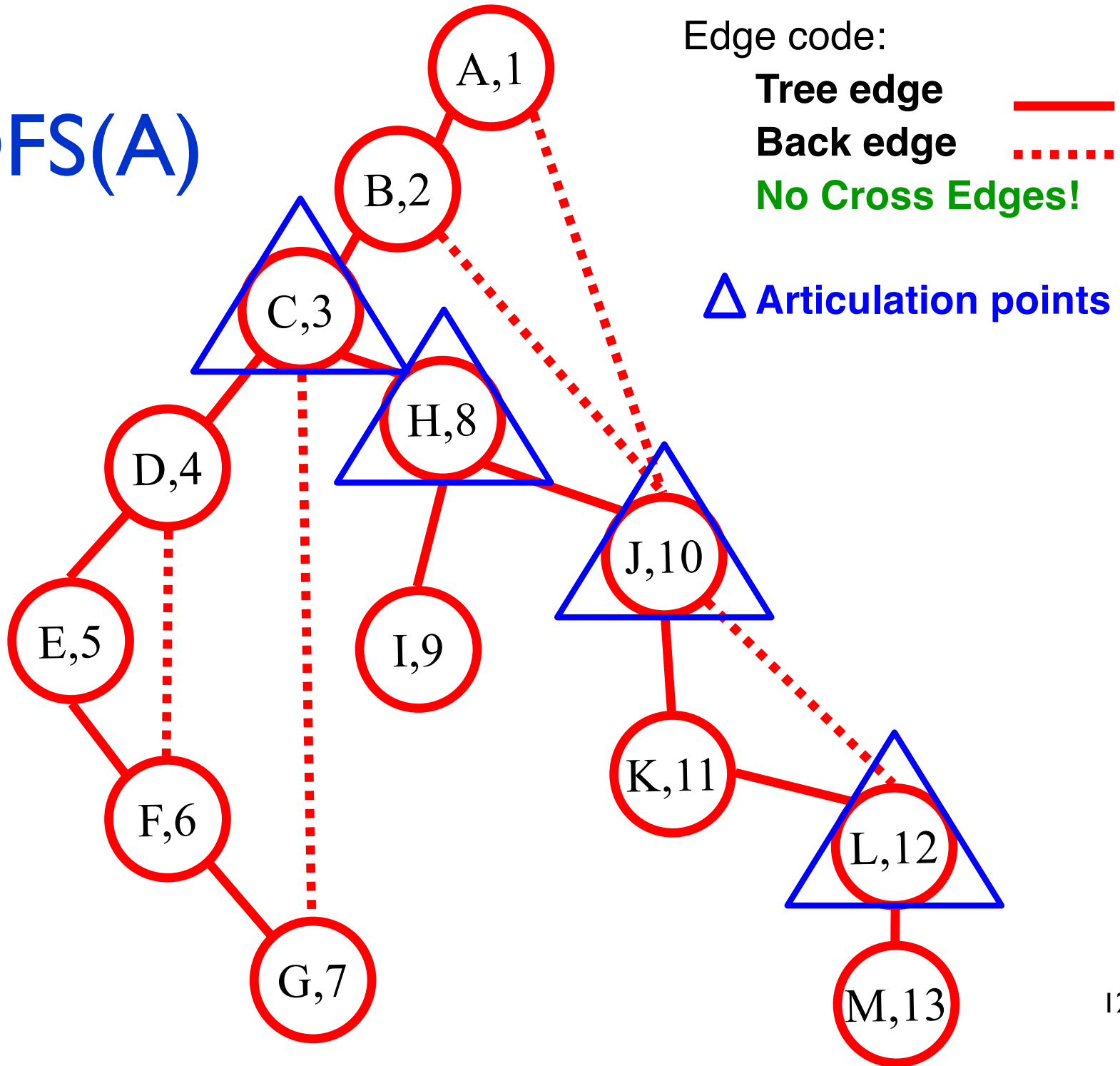

Articulation Points from DFS

Root node is an articulation point
iff it has more than one child

Leaf is never an articulation point

Non-leaf, non-root node
 u is an articulation point



\exists some child y of u s.t.
no non-tree edge goes
above u from y or below

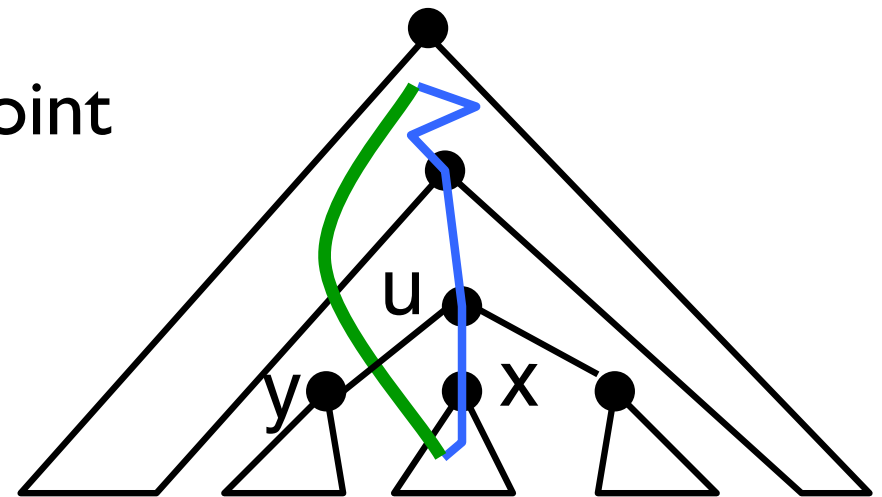

If u 's removal does NOT separate x , there must be an exit from x 's subtree. How? Via back edge.

$LOW(v)$ = highest exit from v 's subtree

Articulation Points: the "LOW" function

trivial

Definition: $LOW(v)$ is the lowest dfs# of any vertex that is either in the dfs subtree rooted at v (including v itself) or directly connected to a vertex in that subtree by one back edge.

critical

Key idea 1: if some child x of v has $LOW(x) \geq \text{dfs\#}(v)$ then v is an articulation point (excl. root)

Key idea 2: $LOW(v) = \min (\{ \text{dfs\#}(v) \} \cup \{ LOW(w) \mid w \text{ a child of } v \} \cup \{ \text{dfs\#}(x) \mid \{v,x\} \text{ is a back edge from } v \})$

DFS To Find Articulation Points

Global initialization: $\text{dfscounter} = 0$; $v.\text{dfs\#} = -1$ for all v .

DFS(v):

```
v.dfs# = dfscounter++
```

```
v.low = v.dfs# // initialization
```

```
for each edge {v,x}
```

```
  if (x.dfs# == -1) // x is undiscovered
```

```
    DFS(x)
```

```
    v.low = min(v.low, x.low)
```

```
    if (x.low >= v.dfs#)
```

```
      print "v is art. pt., separating x"
```

```
    else if (x is not v's parent)
```

```
      v.low = min(v.low, x.dfs#)
```

Except for root. Why?
What if G is not connected?

Equiv: "if({v,x}
is a back edge)"
Why?

$LOW(v)$ = highest exit from v 's subtree

Articulation Point

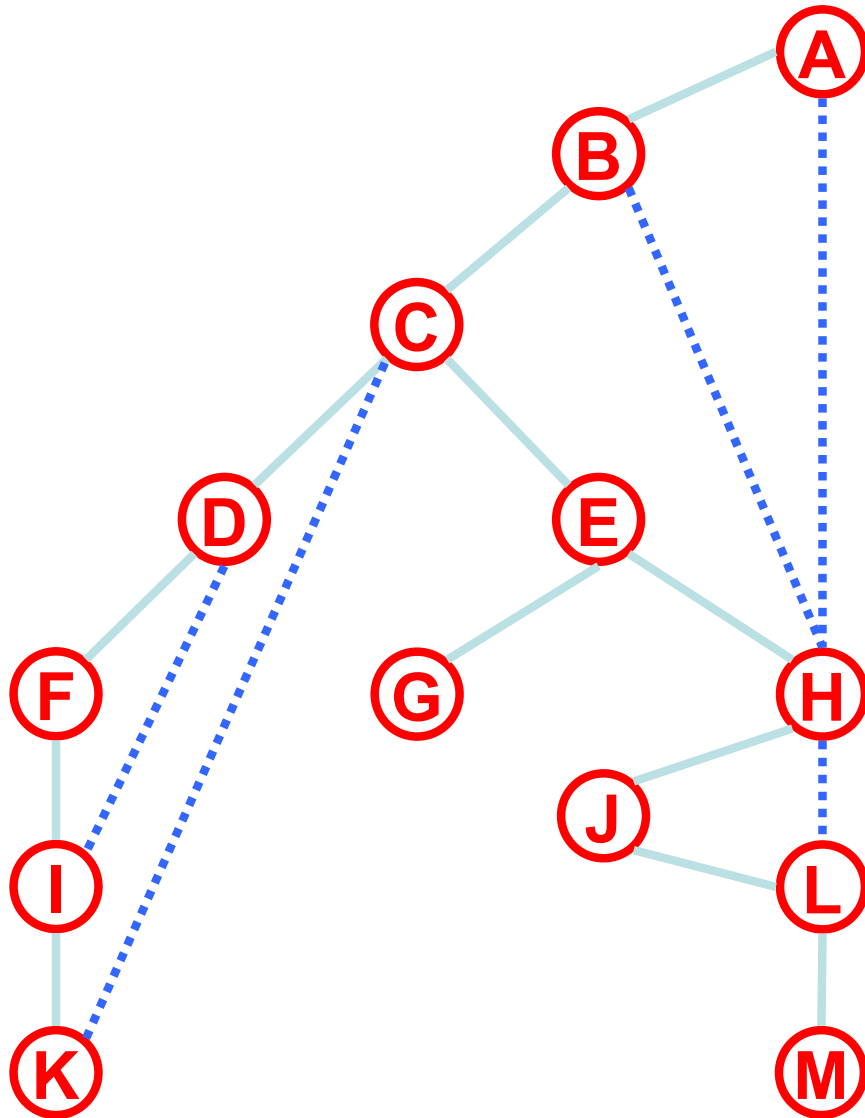
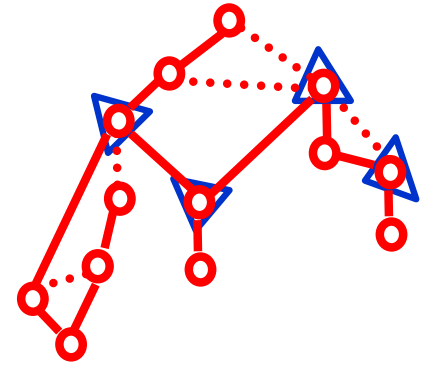

Vertex	DFS #	Low
A		
B		
C		
D		
E		
F		
G		
H		
I		
J		
K		
L		
M		

$LOW(v)$ = highest exit from v 's subtree

Articulation Points

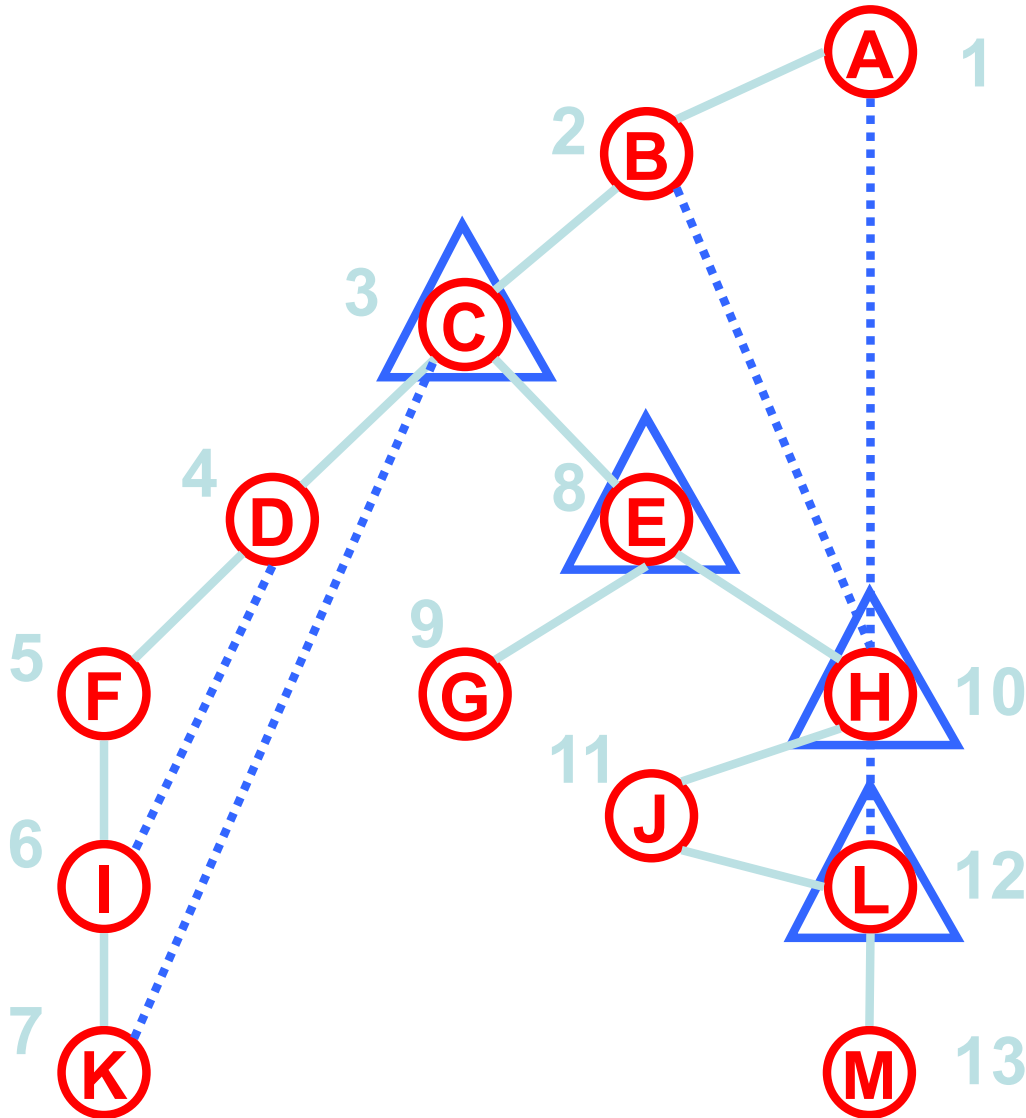

Vertex	DFS #	Low
A	1	1
B	2	1
C	3	1
D	4	3
E	8	1
F	5	3
G	9	9
H	10	1
I	6	3
J	11	10
K	7	3
L	12	10
M	13	13

Summary

Graphs – abstract relationships among pairs of objects

Terminology – node/vertex/vertices, edges, paths, multi-edges, self-loops, connected

Representation – edge list, adjacency matrix

Nodes vs Edges – $m = O(n^2)$, often less (sparse/dense)

BFS – Layers, queue, shortest paths, all edges go to same or adjacent layer, tree, global analysis of nested loops

DFS – recursion/stack; all edges ancestor/descendant

Algorithms – connected components, shortest path, bipartiteness, topological sort, articulation points