



CSE 332: Data Abstractions

Lecture 16: Shortest Paths

Ruth Anderson

Spring 2013

Announcements

- **Homework 4** – due Friday May 10th
- **Project 2** – Phase B due Tues May 14th at 11pm
- **Homework 5** – due Fri May 17th

Today

- Graphs
 - Graph Traversals
 - Shortest Paths

Shortest Path Applications

- Network routing
- Driving directions
- Cheap flight tickets
- Critical paths in project management
(see textbook)
- ...

Single source shortest paths

- Done: BFS to find the minimum path length from \mathbf{v} to \mathbf{u} in $O(|E|+|V|)$
- Actually, can find the minimum path length from \mathbf{v} to *every node*
 - Still $O(|E|+|V|)$
 - No faster way for a “distinguished” destination in the worst-case
- Now: Weighted graphs

Given a weighted graph and node \mathbf{v} ,
find the minimum-cost path from \mathbf{v} to every node

- As before, asymptotically no harder than for one destination
- Unlike before, BFS will not work

Not as easy

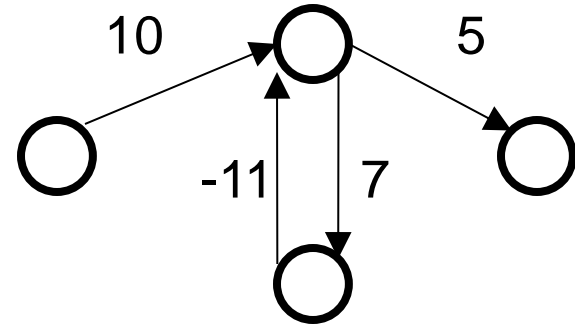
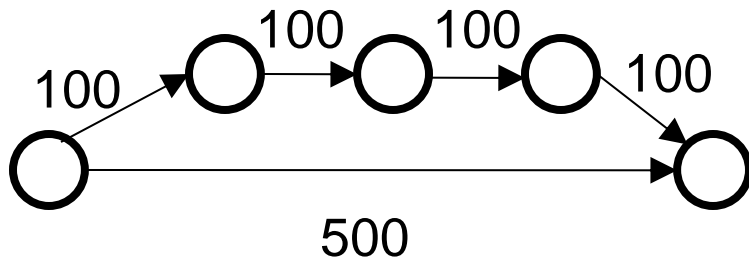

Why BFS won't work: Shortest path may not have the fewest edges

- Annoying when this happens with costs of flights

We will assume there are no negative weights

- *Problem* is *ill-defined* if there are negative-cost *cycles*
- *Today's algorithm* is *wrong* if edges can be negative
 - See homework

Dijkstra's Algorithm

- Named after its inventor Edsger Dijkstra (1930-2002)
 - Truly one of the “founders” of computer science; 1972 Turing Award; this is just one of his many contributions
 - Sample quotation: “computer science is no more about computers than astronomy is about telescopes”
- The idea: reminiscent of BFS, but adapted to handle weights
 - Grow the set of nodes whose shortest distance has been computed
 - Nodes not in the set will have a “best distance so far”
 - A priority queue will turn out to be useful for efficiency

Dijkstra's Algorithm: Idea

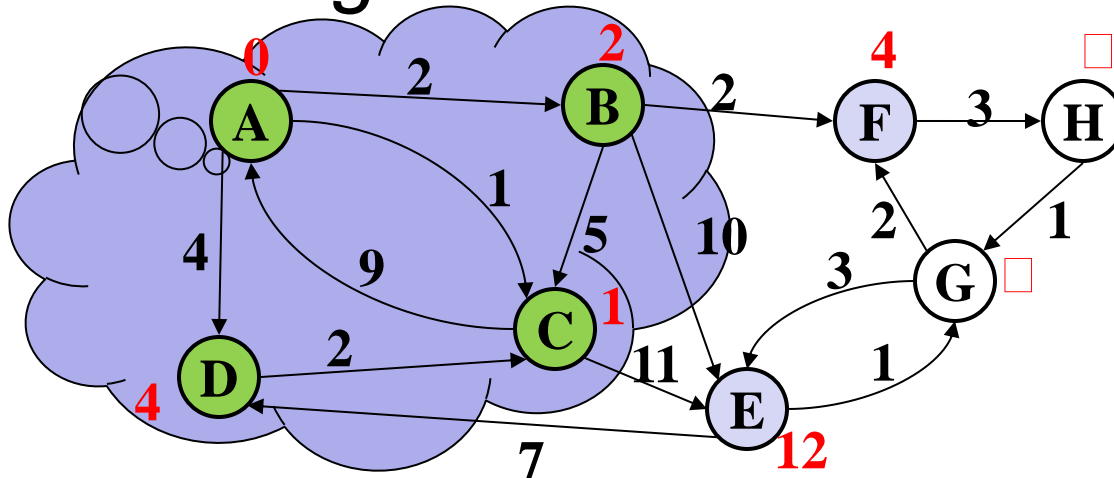

- Initially, start node has cost 0 and all other nodes have cost ∞
- At each step:
 - Pick closest unknown vertex v
 - Add it to the “cloud” of known vertices
 - Update distances for nodes with edges from v
- That's it! (Have to prove it produces correct answers)

The Algorithm

1. For each node v , set $v.cost = \infty$ and $v.known = false$
2. Set $source.cost = 0$
3. While there are unknown nodes in the graph
 - a) Select the unknown node v with lowest cost
 - b) Mark v as known
 - c) For each edge (v, u) with weight w ,

```
c1 = v.cost + w // cost of best path through v to u
c2 = u.cost // cost of best path to u previously known
if (c1 < c2) { // if the path through v is better
    u.cost = c1
    u.path = v // for computing actual paths
}
```

Important features

- Once a vertex is marked known, the cost of the shortest path to that node is known
 - The path is also known by following back-pointers
- While a vertex is still not known, another shorter path to it might still be found

Example #1

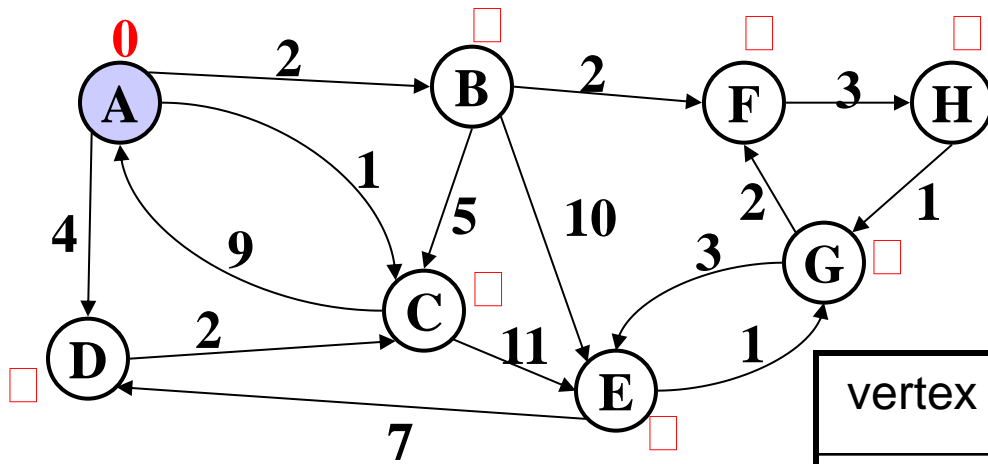

vertex	known?	cost	path
A			
B			
C			
D			
E			
F			
G			
H			

Order Added to Known Set:

Example #1

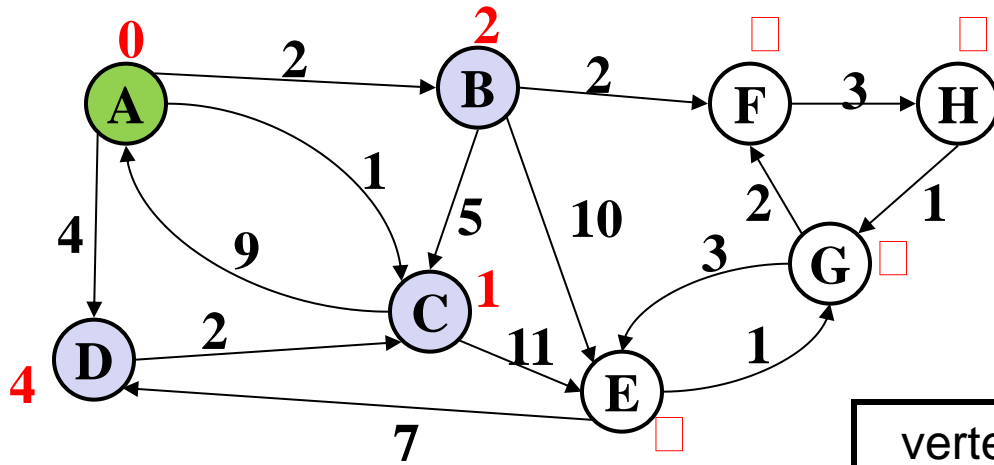

vertex	known?	cost	path
A	Y	0	
B		≤ 2	A
C		≤ 1	A
D		≤ 4	A
E		??	
F		??	
G		??	
H		??	

Order Added to Known Set:

A

Example #1

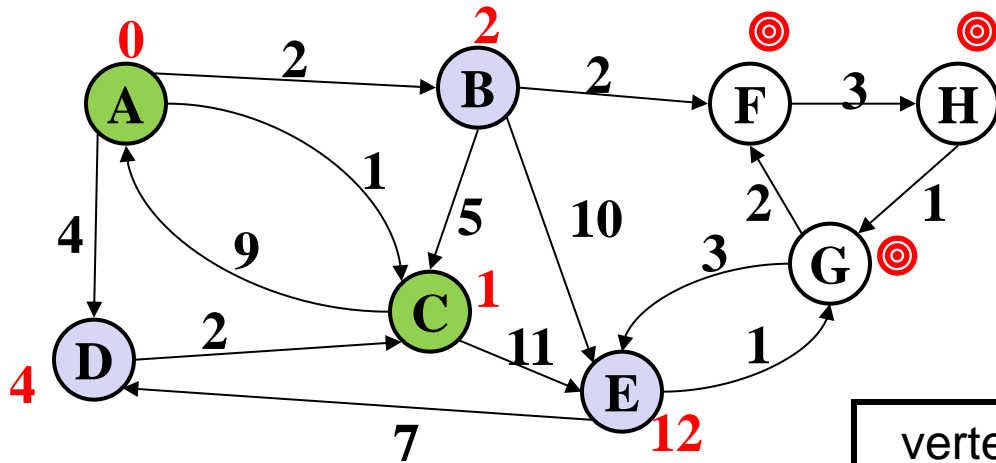

vertex	known?	cost	path
A	Y	0	
B		≤ 2	A
C	Y	1	A
D		≤ 4	A
E		≤ 12	C
F		??	
G		??	
H		??	

Order Added to Known Set:

A, C

Example #1

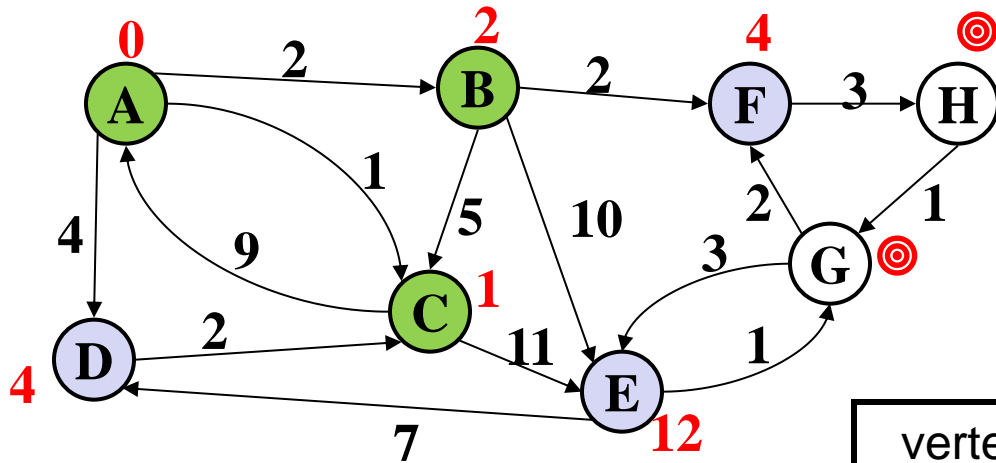

vertex	known?	cost	path
A	Y	0	
B	Y	2	A
C	Y	1	A
D		≤ 4	A
E		≤ 12	C
F		≤ 4	B
G		??	
H		??	

Order Added to Known Set:

A, C, B

Example #1

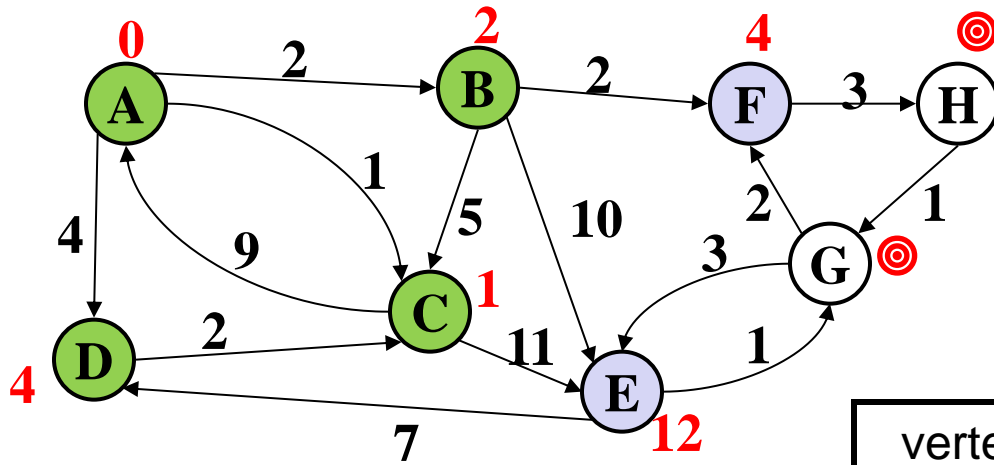

vertex	known?	cost	path
A	Y	0	
B	Y	2	A
C	Y	1	A
D	Y	4	A
E		≤ 12	C
F		≤ 4	B
G		??	
H		??	

Order Added to Known Set:

A, C, B, D

Example #1

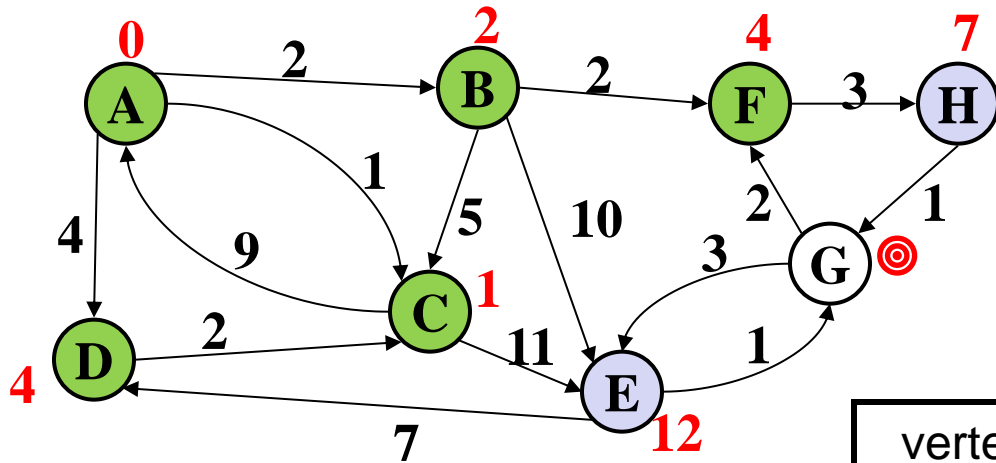

vertex	known?	cost	path
A	Y	0	
B	Y	2	A
C	Y	1	A
D	Y	4	A
E		≤ 12	C
F	Y	4	B
G		??	
H		≤ 7	F

Order Added to Known Set:

A, C, B, D, F

Example #1

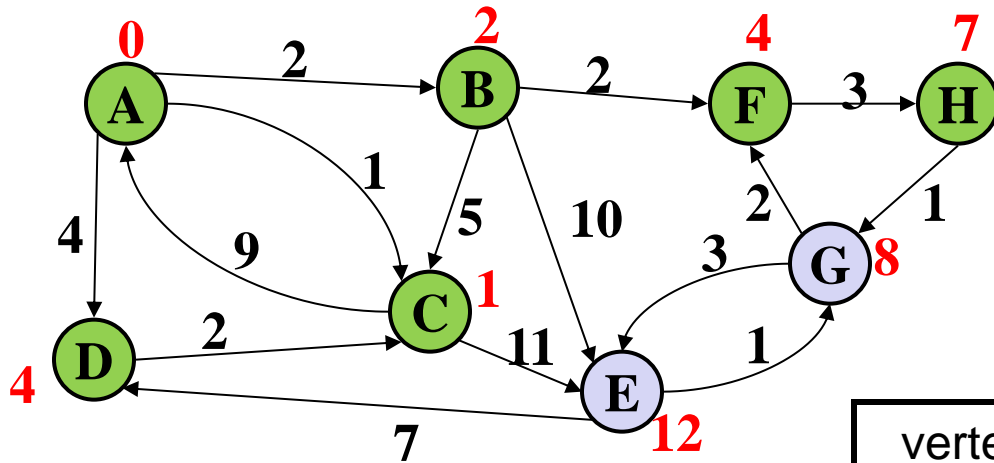

vertex	known?	cost	path
A	Y	0	
B	Y	2	A
C	Y	1	A
D	Y	4	A
E		≤ 12	C
F	Y	4	B
G		≤ 8	H
H	Y	7	F

Order Added to Known Set:

A, C, B, D, F, H

Example #1

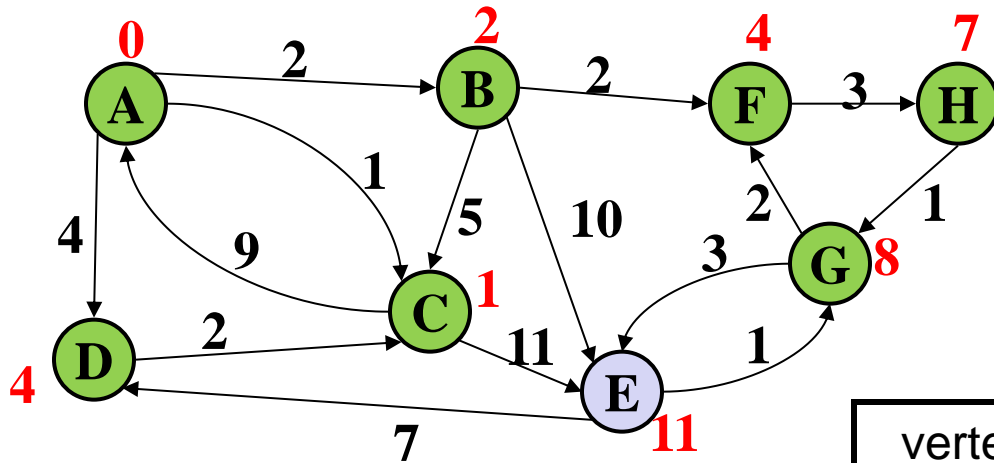

vertex	known?	cost	path
A	Y	0	
B	Y	2	A
C	Y	1	A
D	Y	4	A
E		≤ 11	G
F	Y	4	B
G	Y	8	H
H	Y	7	F

Order Added to Known Set:

A, C, B, D, F, H, G

Example #1

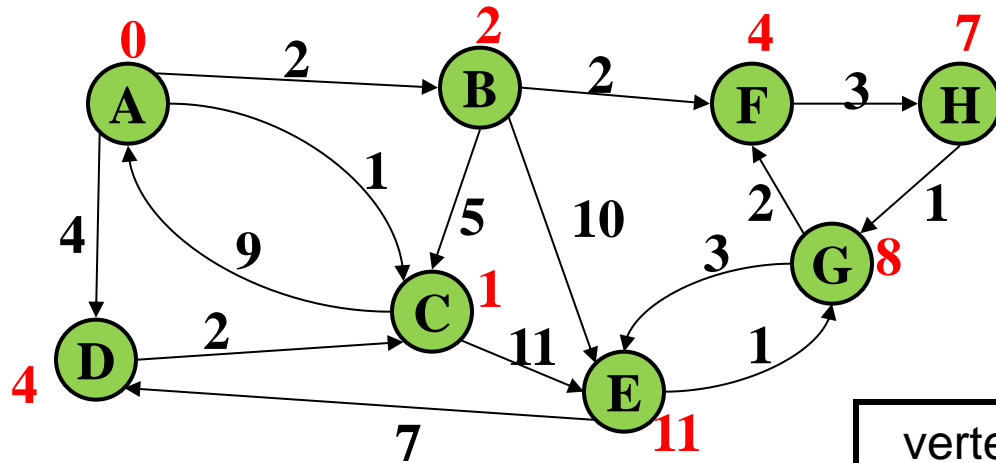

vertex	known?	cost	path
A	Y	0	
B	Y	2	A
C	Y	1	A
D	Y	4	A
E	Y	11	G
F	Y	4	B
G	Y	8	H
H	Y	7	F

Order Added to Known Set:

A, C, B, D, F, H, G, E

Features

- When a vertex is marked known, the cost of the shortest path to that node is known
 - The path is also known by following back-pointers
- While a vertex is still not known, another shorter path to it **might** still be found

Note: The “Order Added to Known Set” is not important

- A detail about how the algorithm works (client doesn't care)
- Not used by the algorithm (implementation doesn't care)
- It is sorted by path-cost, resolving ties in some way

Interpreting the Results

- Now that we're done, how do we get the path from, say, A to E?

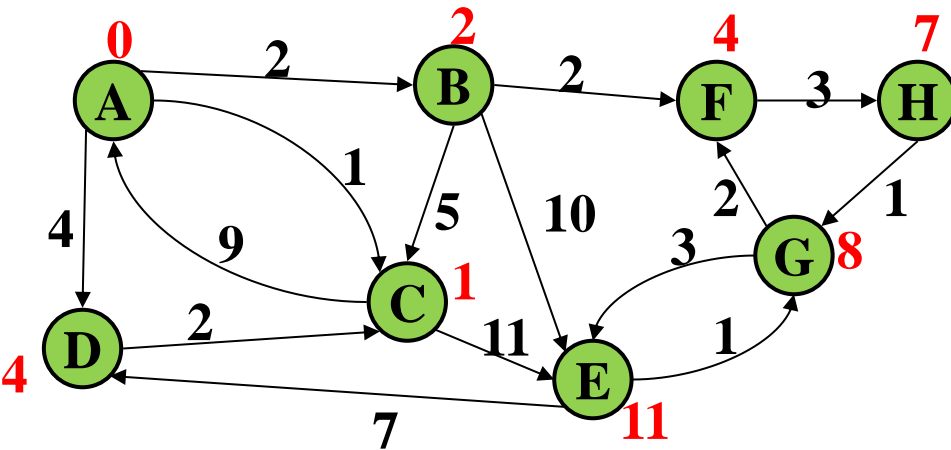

Order Added to Known Set:

A, C, B, D, F, H, G, E

vertex	known?	cost	path
A	Y	0	
B	Y	2	A
C	Y	1	A
D	Y	4	A
E	Y	11	G
F	Y	4	B
G	Y	8	H
H	Y	7	F

Stopping Short

- How would this have worked differently if we were only interested in:
 - The path from A to G?
 - The path from A to D?

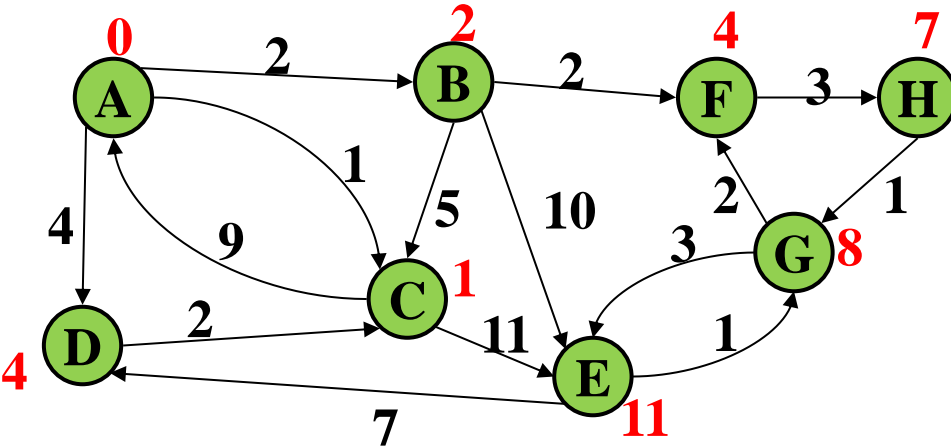

Order Added to Known Set:

A, C, B, D, F, H, G, E

vertex	known?	cost	path
A	Y	0	
B	Y	2	A
C	Y	1	A
D	Y	4	A
E	Y	11	G
F	Y	4	B
G	Y	8	H
H	Y	7	F

Example #2

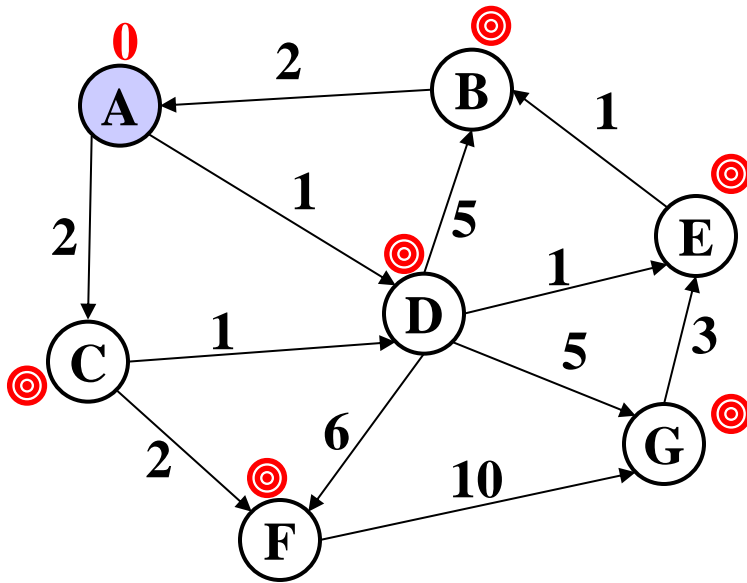

vertex	known?	cost	path
A		0	
B			
C			
D			
E			
F			
G			

Order Added to Known Set:

Example #2

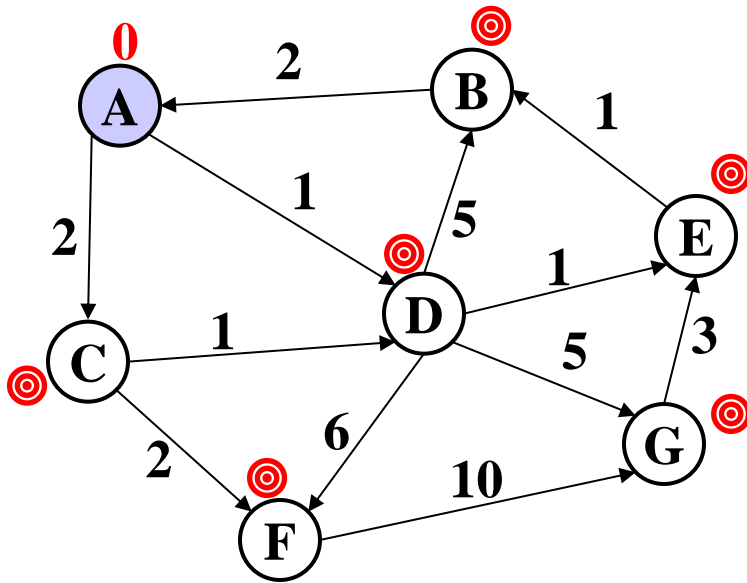

vertex	known?	cost	path
A		0	
B		??	
C		??	
D		??	
E		??	
F		??	
G		??	

Order Added to Known Set:

Example #2

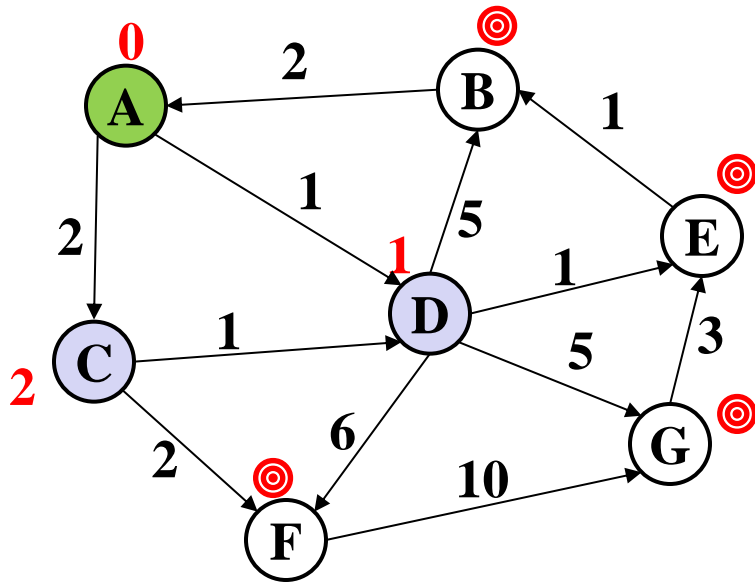

vertex	known?	cost	path
A	Y	0	
B		??	
C		≤ 2	A
D		≤ 1	A
E		??	
F		??	
G		??	

Order Added to Known Set:

A

Example #2

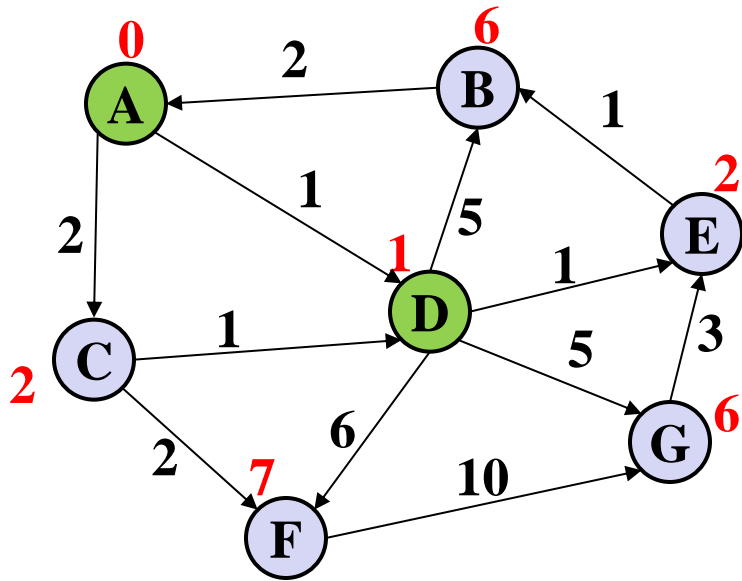

vertex	known?	cost	path
A	Y	0	
B		≤ 6	D
C		≤ 2	A
D	Y	1	A
E		≤ 2	D
F		≤ 7	D
G		≤ 6	D

Order Added to Known Set:

A, D

Example #2

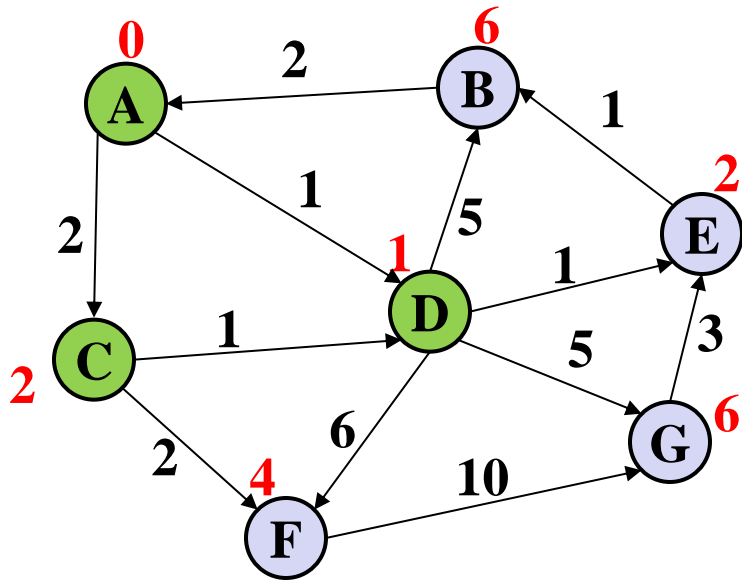

vertex	known?	cost	path
A	Y	0	
B		≤ 6	D
C	Y	2	A
D	Y	1	A
E		≤ 2	D
F		≤ 4	C
G		≤ 6	D

Order Added to Known Set:

A, D, C

Example #2

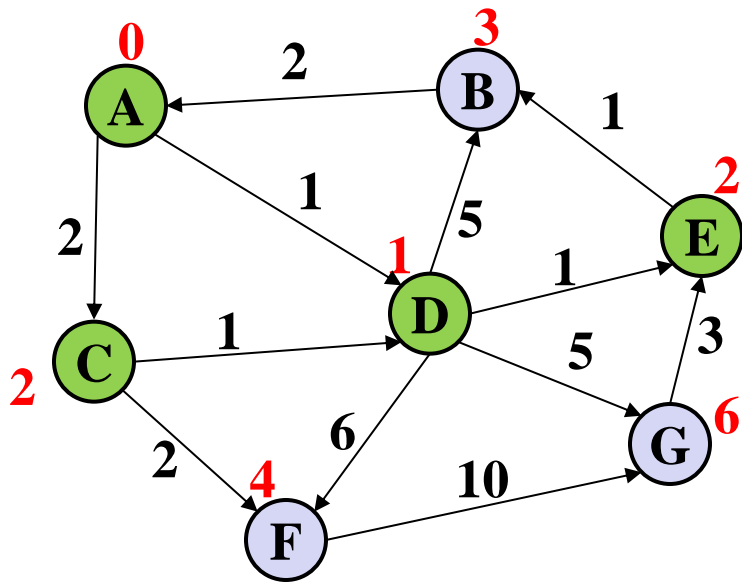

vertex	known?	cost	path
A	Y	0	
B		≤ 3	E
C	Y	2	A
D	Y	1	A
E	Y	2	D
F		≤ 4	C
G		≤ 6	D

Order Added to Known Set:

A, D, C, E

Example #2

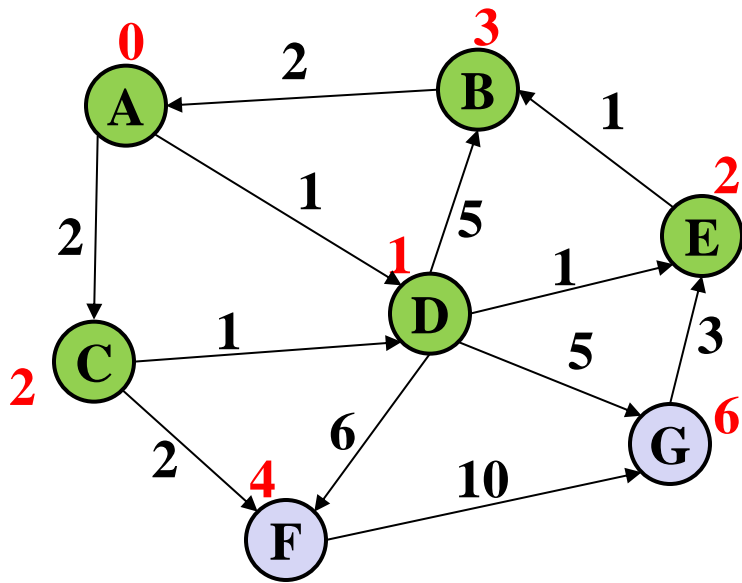

vertex	known?	cost	path
A	Y	0	
B	Y	3	E
C	Y	2	A
D	Y	1	A
E	Y	2	D
F		≤ 4	C
G		≤ 6	D

Order Added to Known Set:

A, D, C, E, B

Example #2

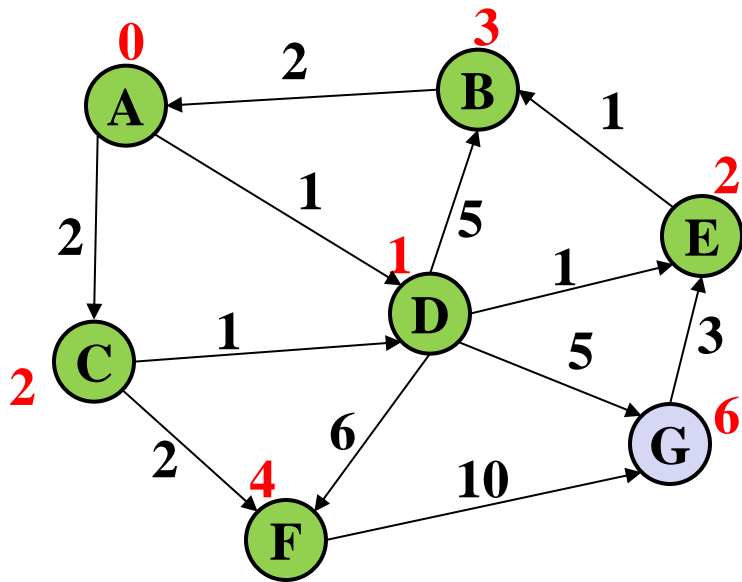

vertex	known?	cost	path
A	Y	0	
B	Y	3	E
C	Y	2	A
D	Y	1	A
E	Y	2	D
F	Y	4	C
G		≤ 6	D

Order Added to Known Set:

A, D, C, E, B, F

Example #2

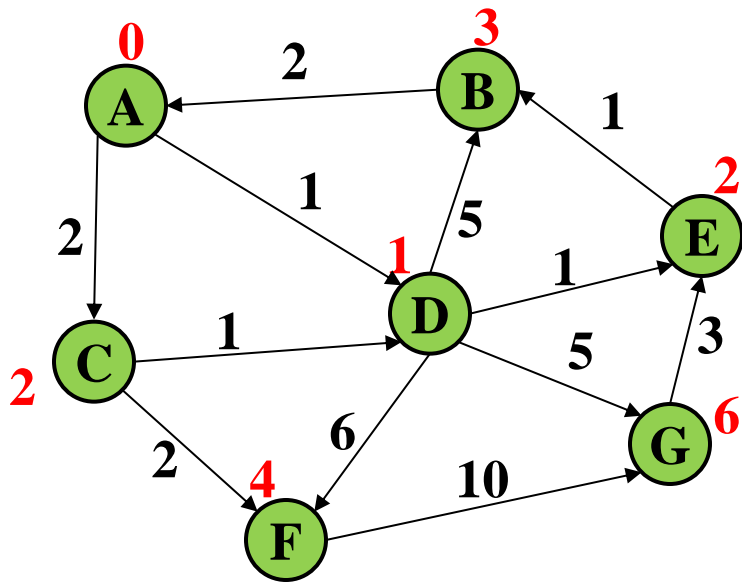

vertex	known?	cost	path
A	Y	0	
B	Y	3	E
C	Y	2	A
D	Y	1	A
E	Y	2	D
F	Y	4	C
G	Y	6	D

Order Added to Known Set:

A, D, C, E, B, F, G

Example #3

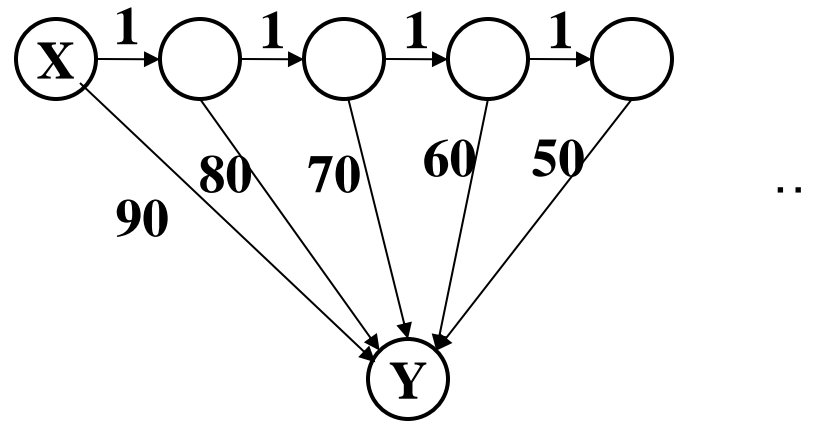

How will the best-cost-so-far for Y proceed?

Is this expensive?

Example #3

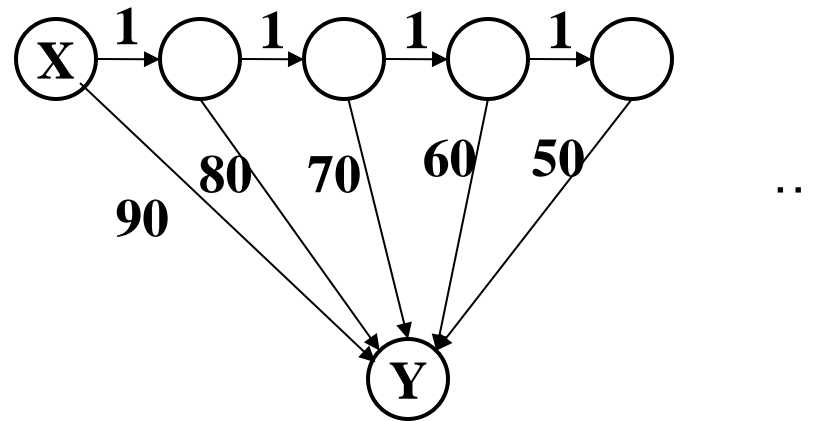

How will the best-cost-so-far for Y proceed? 90, 81, 72, 63, 54, ...

Is this expensive? No, each edge is processed only once

A Greedy Algorithm

- Dijkstra's algorithm
 - For single-source shortest paths in a weighted graph (directed or undirected) with no negative-weight edges
- An example of a *greedy algorithm*:
 - At each step, irrevocably does what seems best at that step
 - A locally optimal step, not necessarily globally optimal
 - Once a vertex is known, it is not revisited
 - Turns out to be globally optimal

Where are we?

- What should we do after learning an algorithm?
 - Prove it is correct
 - Not obvious!
 - We will sketch the key ideas
 - Analyze its efficiency
 - Will do better by using a data structure we learned earlier!

Correctness: Intuition

Rough intuition:

All the “known” vertices have the correct shortest path

- True initially: shortest path to start node has cost 0
- If it stays true every time we mark a node “known”, then by induction this holds and eventually everything is “known”

Key fact we need: When we mark a vertex “known” we won’t discover a shorter path later!

- This holds only because Dijkstra’s algorithm picks the node with the next shortest path-so-far
- The proof is by contradiction...

Correctness: The Cloud (Rough Idea)

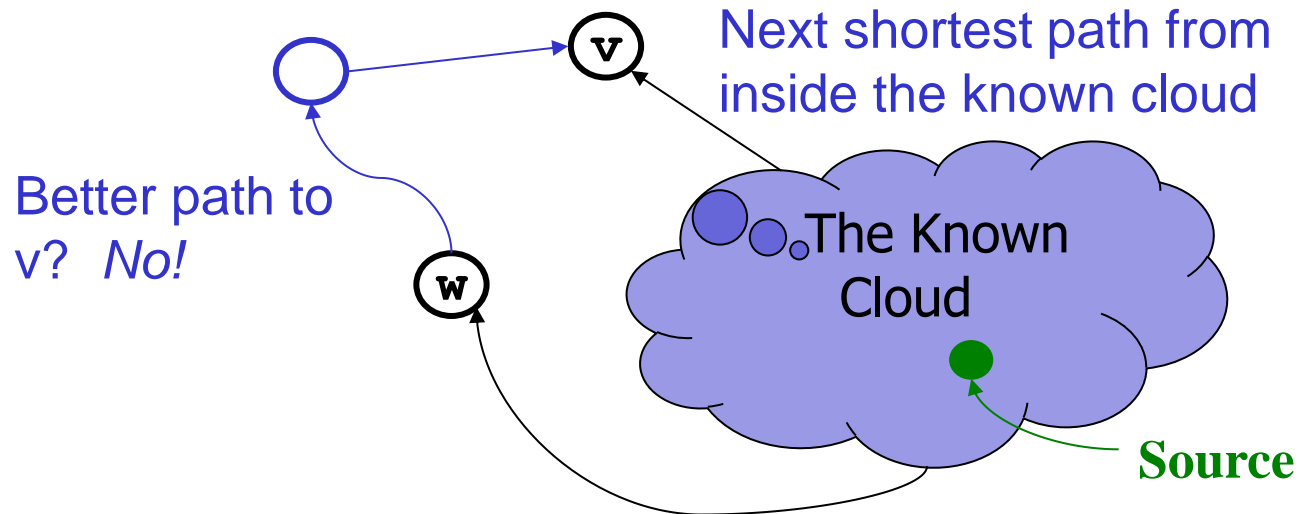

Suppose **v** is the next node to be marked known (“added to the cloud”)

- The **best-known path** to **v** must have only nodes “in the cloud”
 - Since we’ve selected it, and we only know about paths through the cloud to a node right outside the cloud
- Assume the **actual shortest path** to **v** is different
 - It won’t use only cloud nodes, (or we would know about it), so it must use non-cloud nodes
 - Let **w** be the *first* non-cloud node on this path.
 - The part of the path up to **w** is **already known** and must be shorter than the best-known path to **v**. So **v** would not have been picked.

Efficiency, first approach

Use pseudocode to determine asymptotic run-time

- Notice each edge is processed only once

```
dijkstra(Graph G, Node start) {  
  for each node: x.cost=infinity, x.known=false  
  start.cost = 0  
  while(not all nodes are known) {  
    b = find unknown node with smallest cost  
    b.known = true  
    for each edge (b,a) in G  
      if(!a.known)  
        if(b.cost + weight((b,a)) < a.cost) {  
          a.cost = b.cost + weight((b,a))  
          a.path = b  
        }  
  }  
}
```



Efficiency, first approach

Use pseudocode to determine asymptotic run-time

- Notice each edge is processed only once

```
dijkstra(Graph G, Node start) {  
  for each node: x.cost=infinity, x.known=false  
  start.cost = 0  
  while(not all nodes are known) {  
    b = find unknown node with smallest cost  
    b.known = true  
    for each edge (b,a) in G  
      if(!a.known)  
        if(b.cost + weight((b,a)) < a.cost) {  
          a.cost = b.cost + weight((b,a))  
          a.path = b  
        }  
  }  
}
```

$O(|V|)$

$O(|V|^2)$

$O(|E|)$

$O(|V|^2)$

Improving asymptotic running time

- So far: $O(|V|^2)$
- We had a similar “problem” with topological sort being $O(|V|^2)$ due to each iteration looking for the node to process next
 - We solved it with a queue of zero-degree nodes
 - But here we need the lowest-cost node and costs can change as we process edges
- Solution?

Improving (?) asymptotic running time

- So far: $O(|V|^2)$
- We had a similar “problem” with topological sort being $O(|V|^2)$ due to each iteration looking for the node to process next
 - We solved it with a queue of zero-degree nodes
 - But here we need the lowest-cost node and costs can change as we process edges
- Solution?
 - A priority queue holding all unknown nodes, sorted by cost
 - But must support **decreaseKey** operation
 - Must maintain a reference from each node to its position in the priority queue
 - Conceptually simple, but can be a pain to code up

Efficiency, second approach

Use pseudocode to determine asymptotic run-time

```
dijkstra(Graph G, Node start) {  
  for each node: x.cost=infinity, x.known=false  
  start.cost = 0  
  build-heap with all nodes  
  while(heap is not empty) {  
    b = deleteMin()  
    b.known = true  
    for each edge (b,a) in G  
      if(!a.known)  
        if(b.cost + weight((b,a)) < a.cost) {  
          decreaseKey(a, "new cost - old cost")  
          a.path = b  
        }  
  }  
}
```

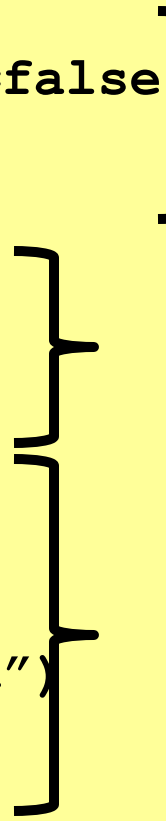

Efficiency, second approach

Use pseudocode to determine asymptotic run-time

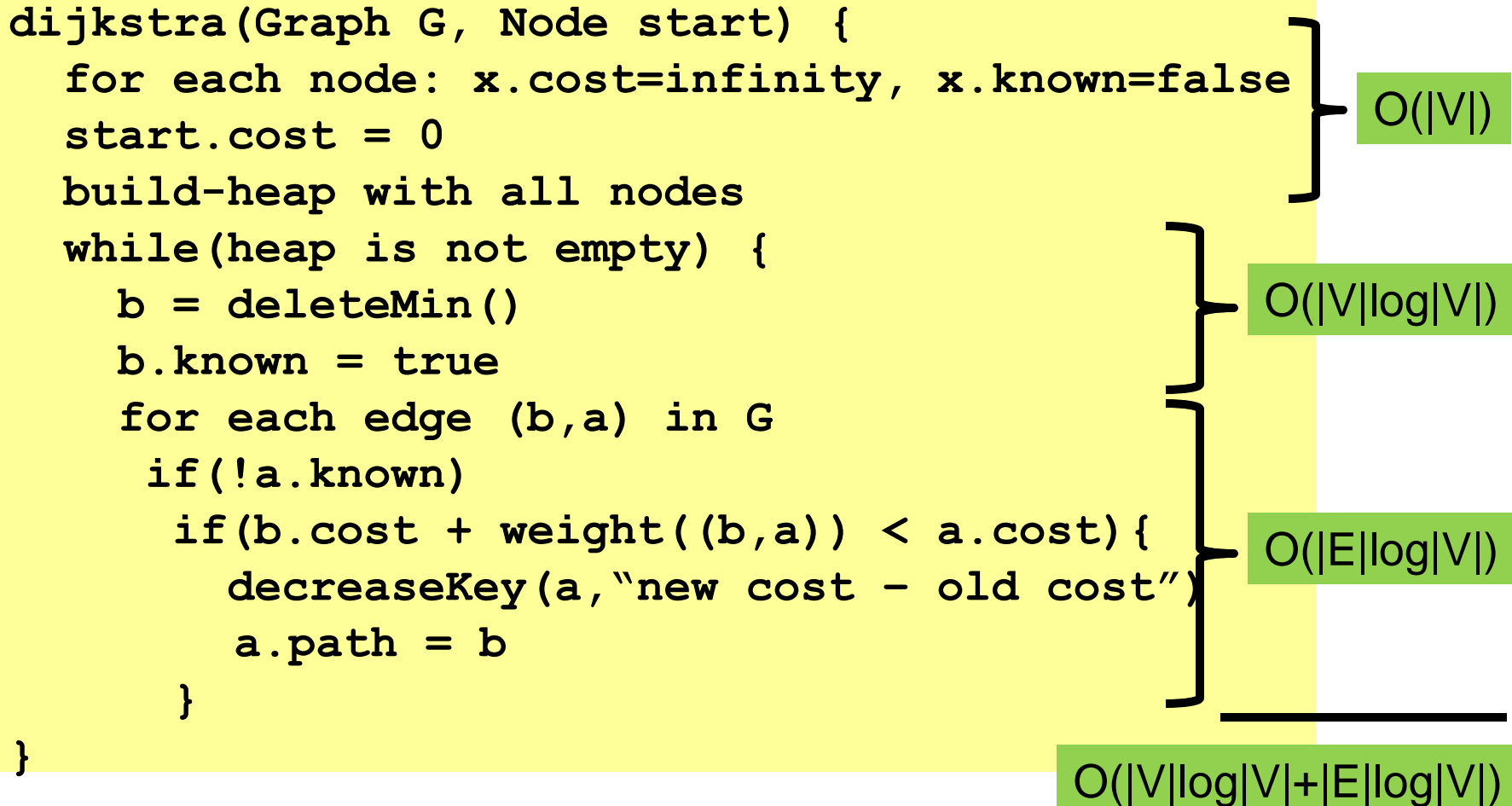

Dense vs. sparse again

- First approach: $O(|V|^2)$
- Second approach: $O(|V|\log|V|+|E|\log|V|)$
- So which is better?
 - Sparse: $O(|V|\log|V|+|E|\log|V|)$ (if $|E| > |V|$, then $O(|E|\log|V|)$)
 - Dense: $O(|V|^2)$
- But, remember these are worst-case and asymptotic
 - Priority queue might have slightly worse constant factors
 - On the other hand, for “normal graphs”, we might call **decreaseKey** rarely (or not percolate far), making $|E|\log|V|$ more like $|E|$

What comes next?

In the logical course progression, we would next study

1. All-pairs-shortest paths
2. Minimum spanning trees

But to align lectures with projects and homeworks, instead we will

- Start parallelism and concurrency
- Come back to graphs at the end of the course
 - We might skip (1) except to point out where to learn more

Note toward the future:

- We can't do all of graphs last because of the CSE312 co-requisite (needed for study of NP)