

Warm up:

Draw a DFA for the language "binary strings that start with a 1 or end with a 1"

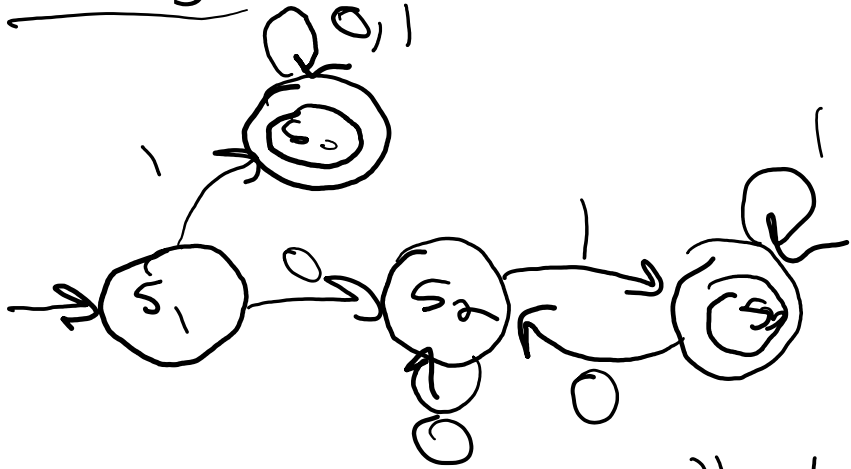

s_2 : didn't start with 1, most recent character was 0



Nondeterministic Finite Automata

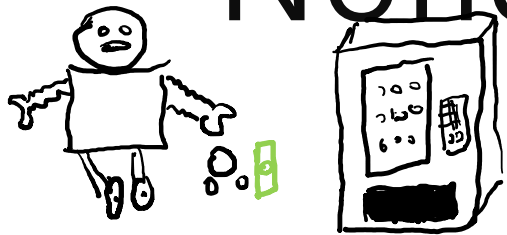

CSE 311 Fall 2020
Lecture 25

The set of binary strings with a 1 in the 3rd position from the start

001 → accept
00 reject
0001 reject

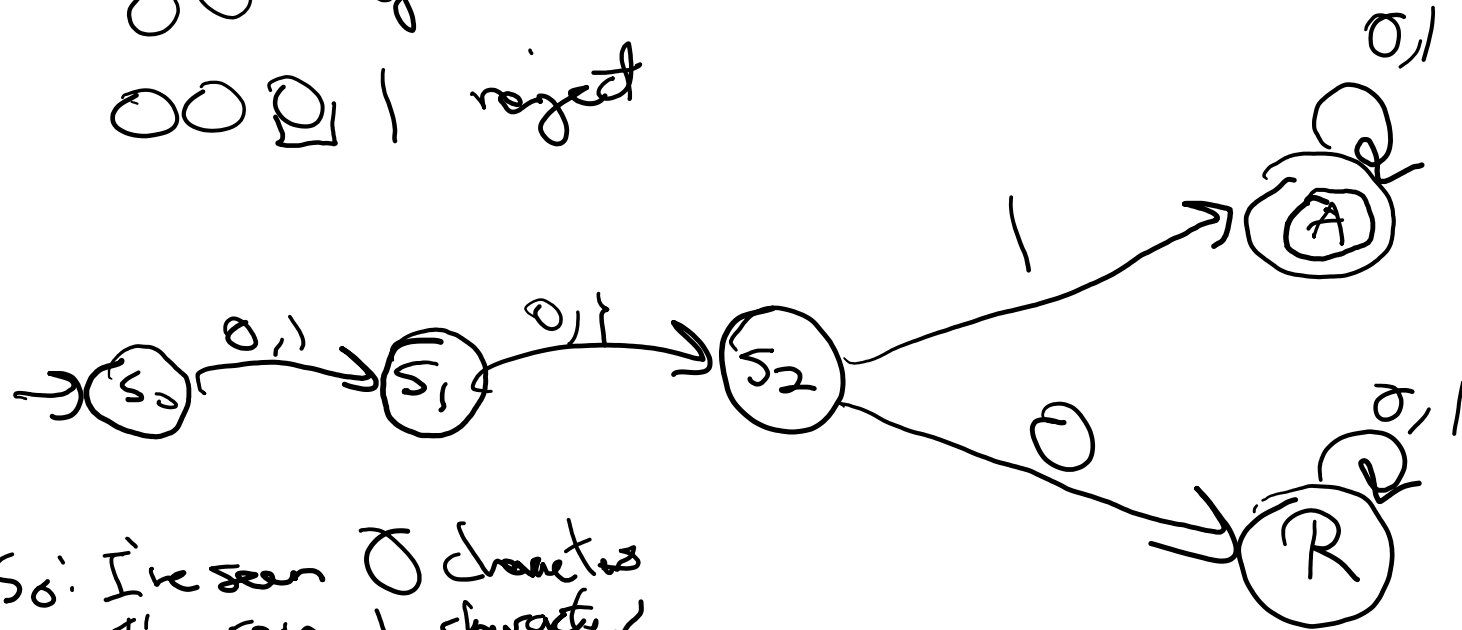

S₀: I've seen 0 characters
S₁: I've seen 1 character

The set of binary strings with a 1 in the 3rd position from the start

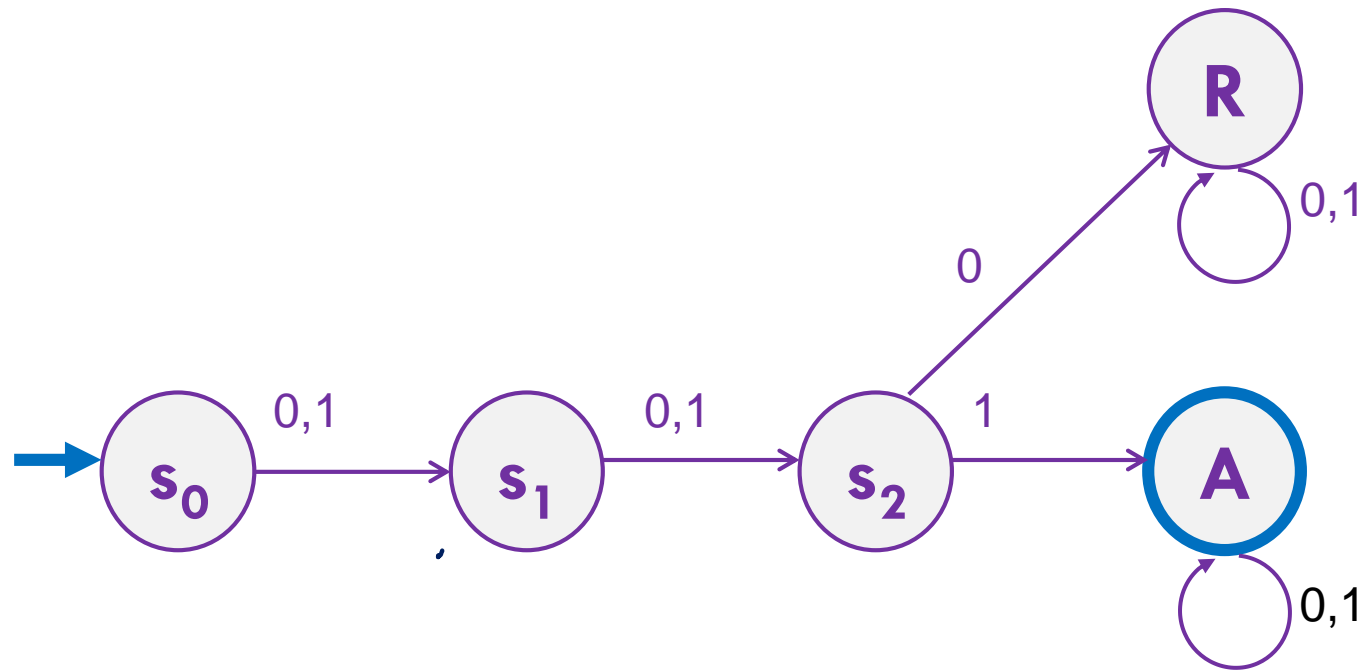

The set of binary strings with a 1 in the 3rd position from the end

What do we need to remember?

↓ 000 ~ accept
001 ↓ 0 ~ accept
00 ~ reject
001 ~ reject

We can't know what string was third from the end until we have read the last character.

So we'll need to keep track of "the character that was 3 ago" in case this was the end of the string.

But if it's not...we'll need the character 2 ago, to update what the character 3 ago becomes. Same with the last character.

3 bit shift register

"Remember the last three bits"

"except binary strings with 1 in third to last position?"

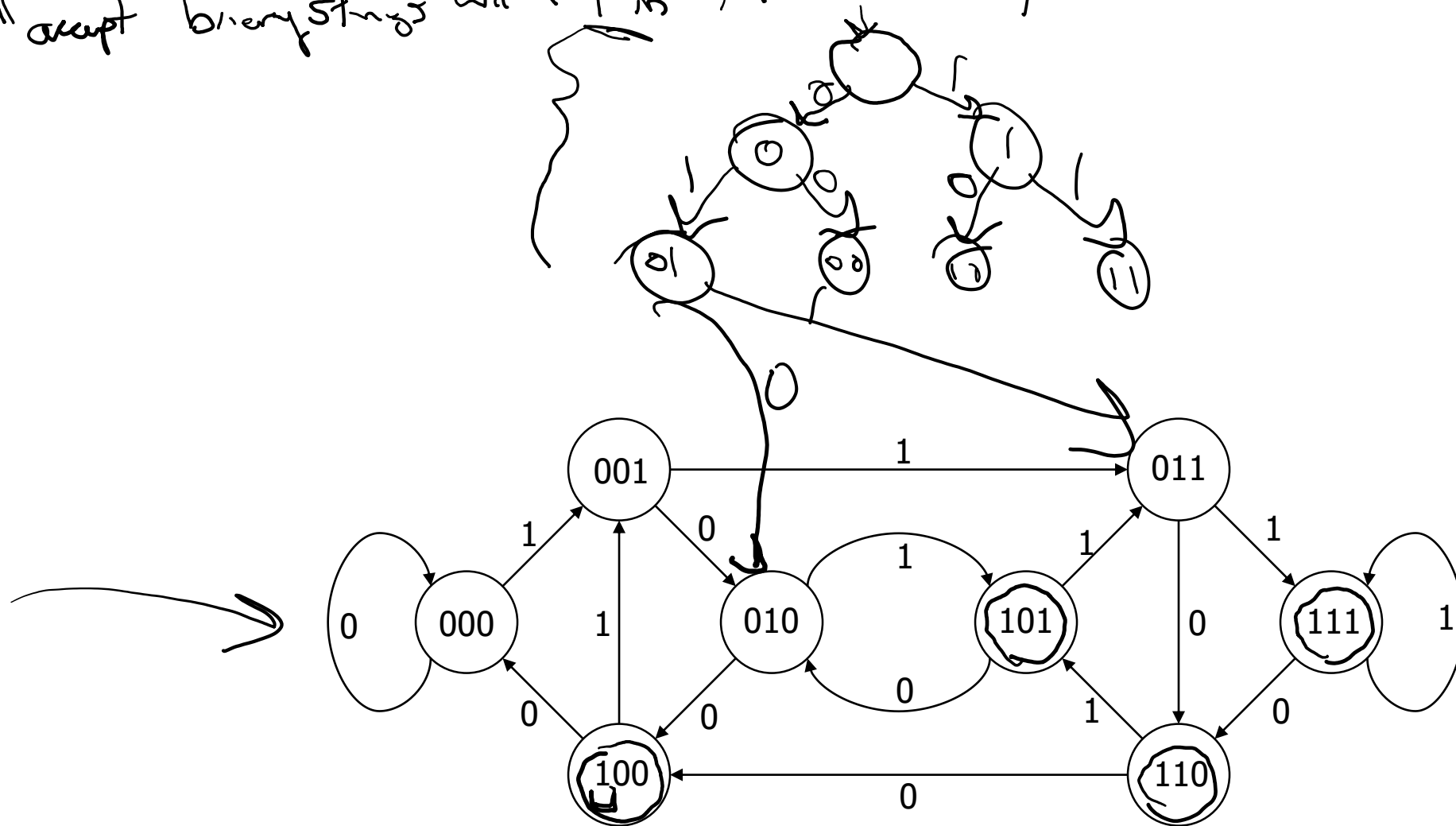

The set of binary strings with a 1 in the 3rd position from the end

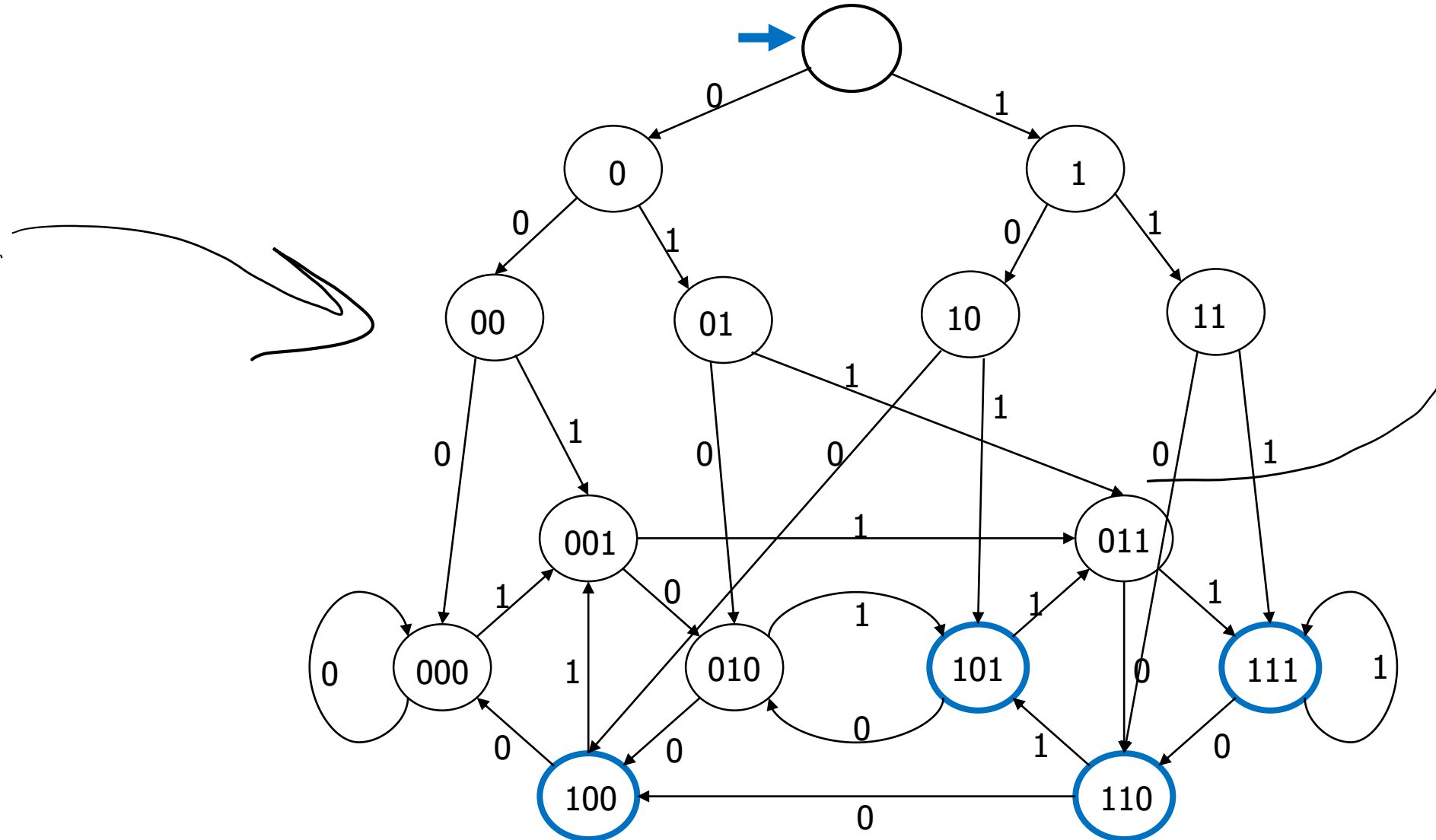

The set of binary strings with a 1 in the 3rd position from the end

$x \in L \iff 000x \in L$

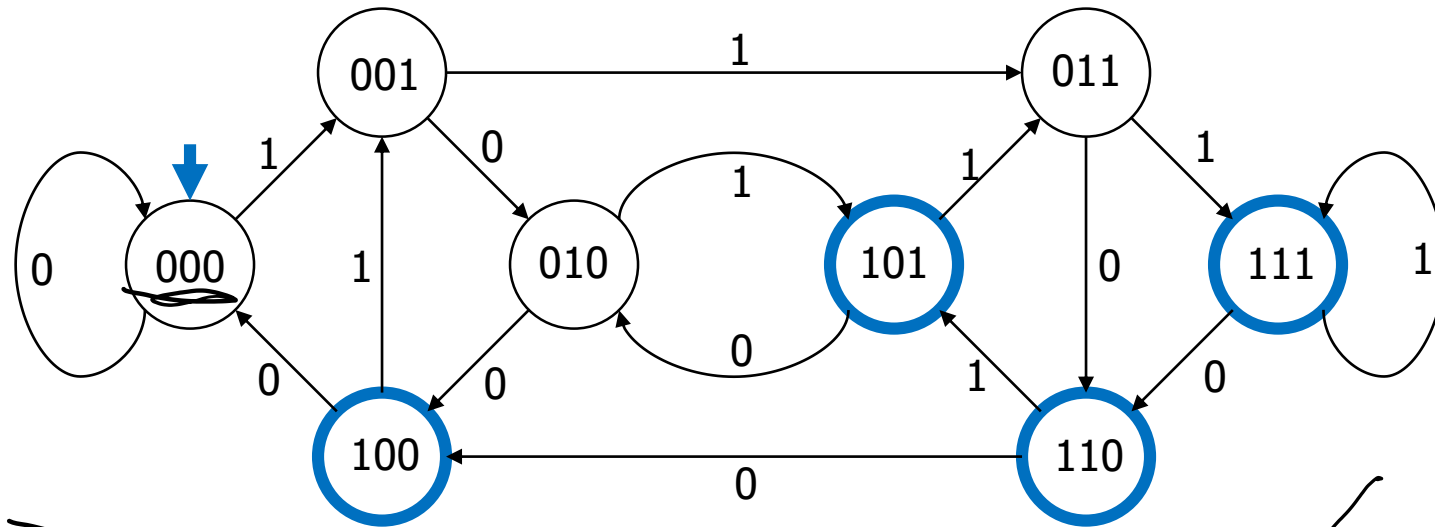

The beginning versus the end

k characters
from the start

k + 2 state DFA

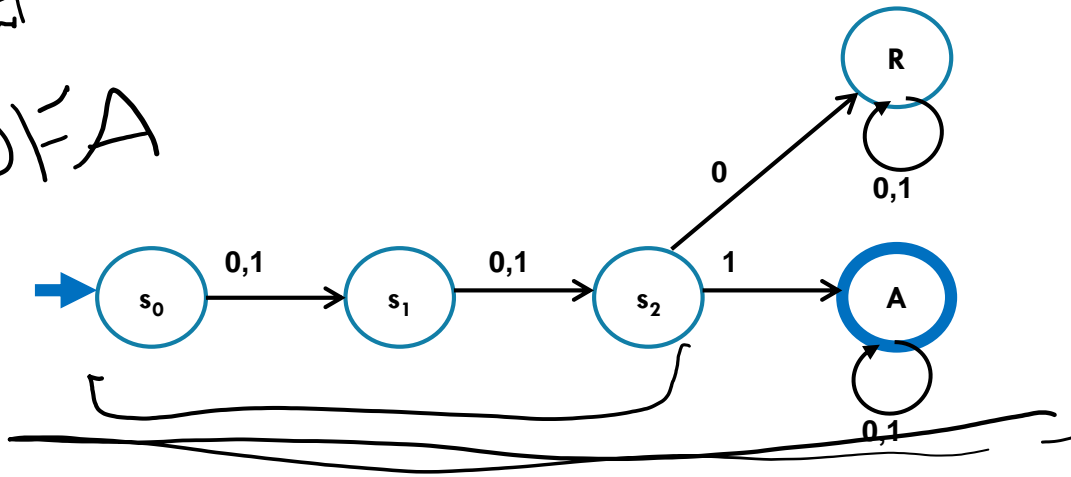

$\sim 2^k$ states
DFA

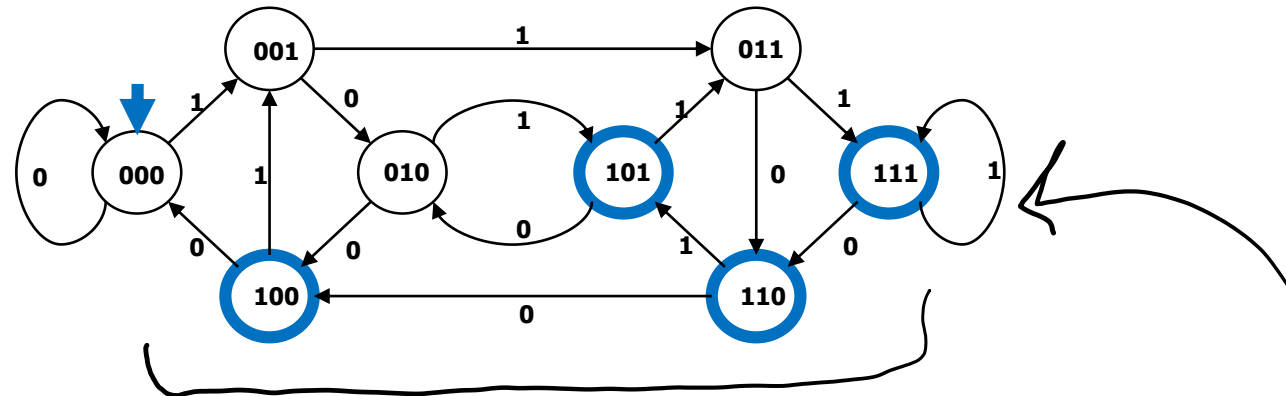

From the beginning was “easier” than “from the end”

At least in the sense that we needed fewer states.

That might be surprising since a java program wouldn't be much different for those two.

Not being able to access the full input at once limits your abilities somewhat and makes some jobs harder than others.

What language does this machine recognize?

Hint: we used the cross product construction

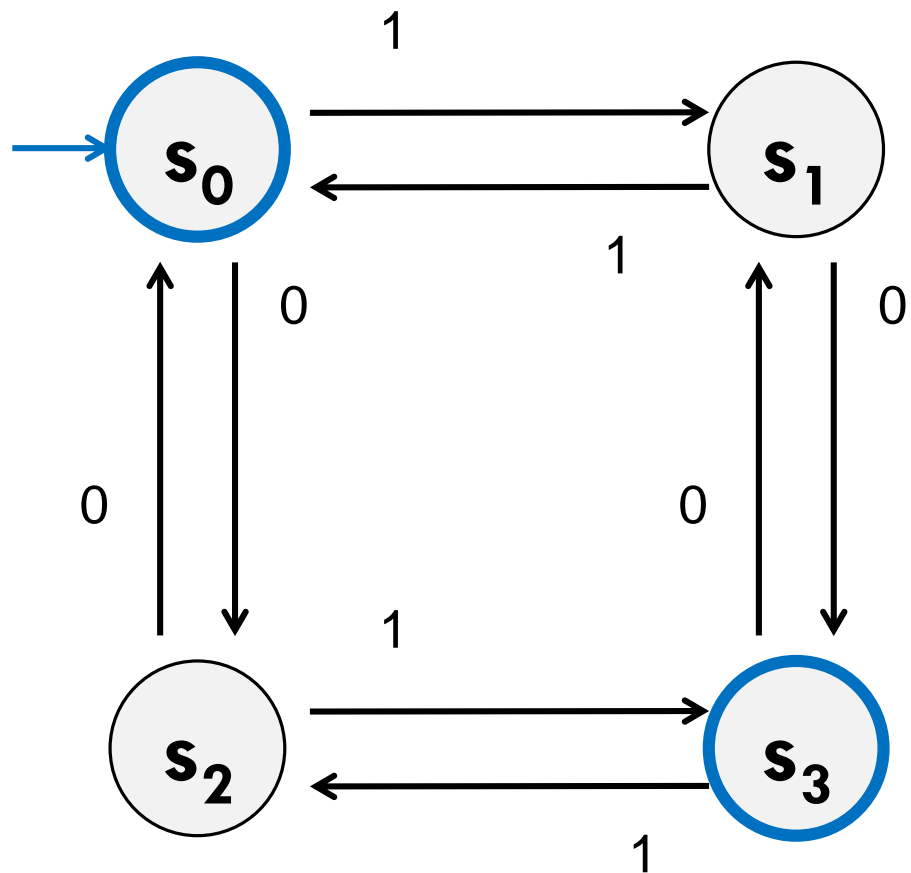

What language does this machine recognize?

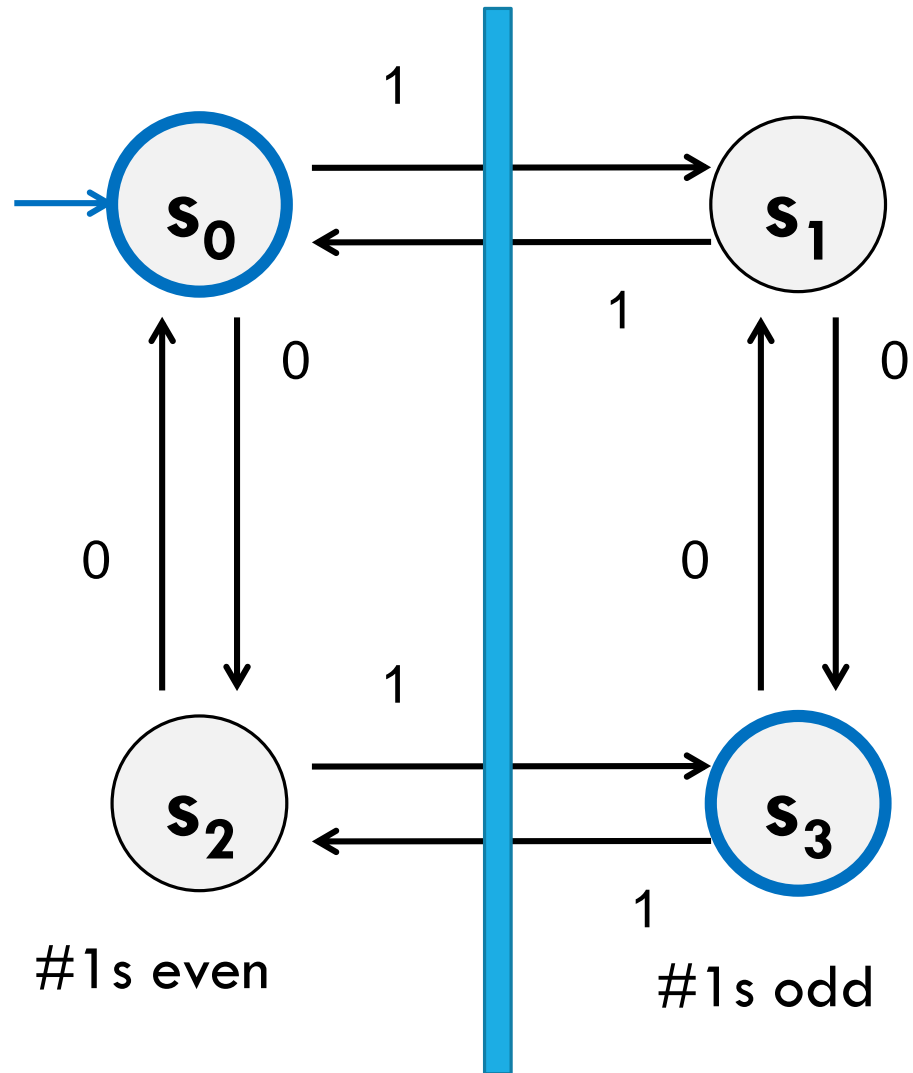

What language does this machine recognize?

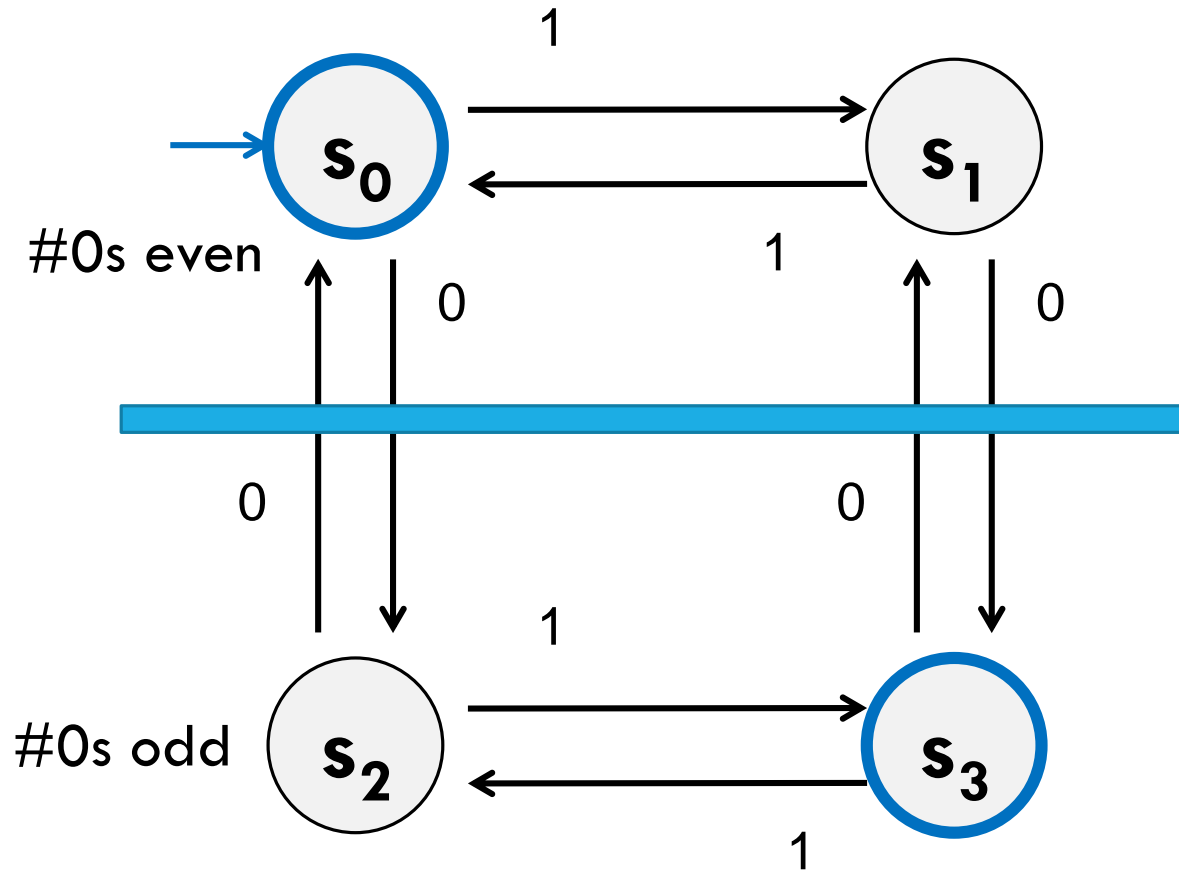

What language does this machine recognize?

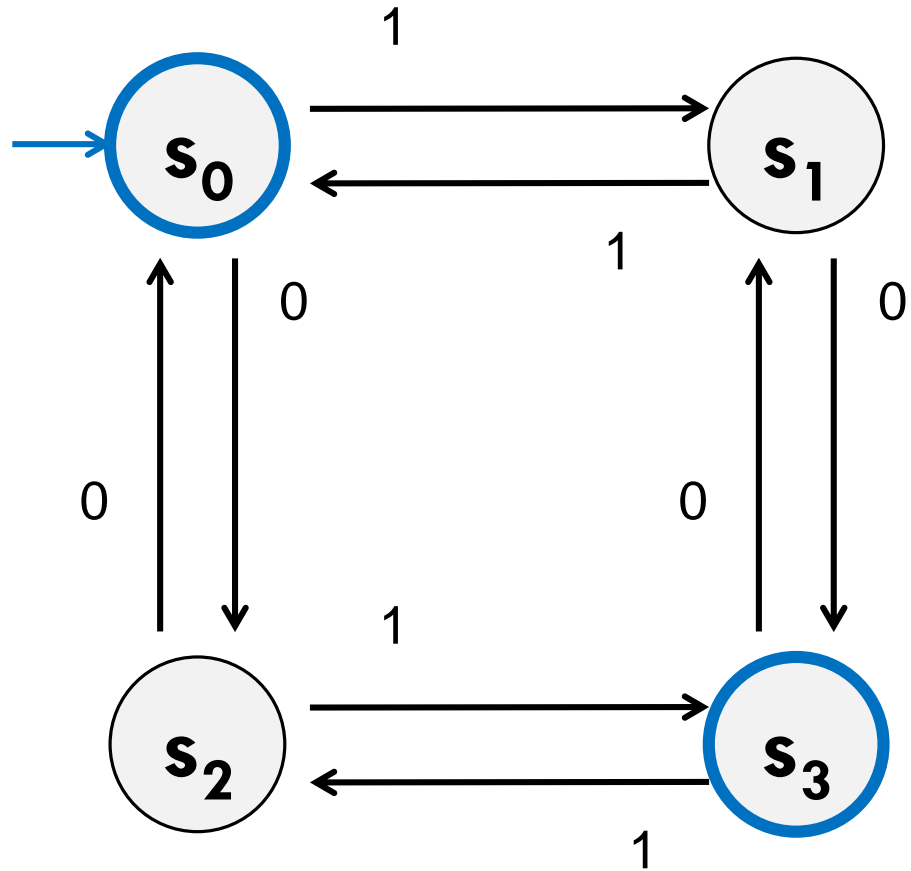

#0s is congruent to #1s (mod 2)

{ Wait...there's an easier way to describe that....

What language does this machine recognize?

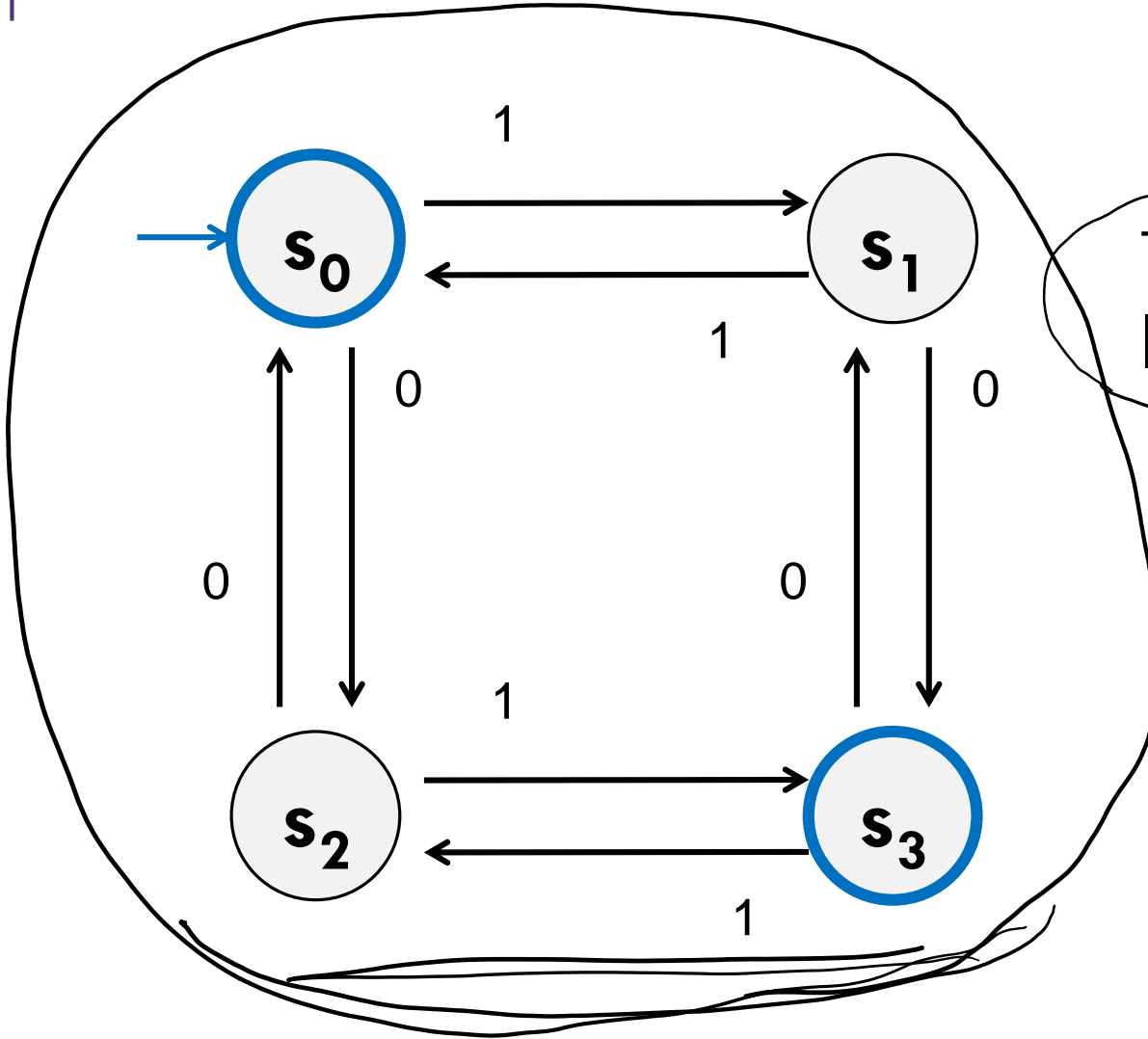

That's all binary strings of even length.

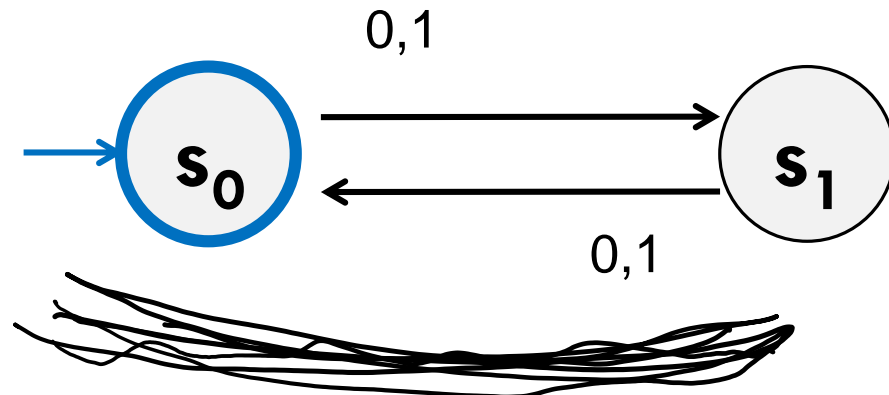

Takeaways

The first DFA might not be the simplest.

Try to think of other descriptions – you might realize you can keep track of fewer things than you thought.

Boy...it'd be nice if we could know that we have the smallest possible DFA for a given language...

DFA Minimization

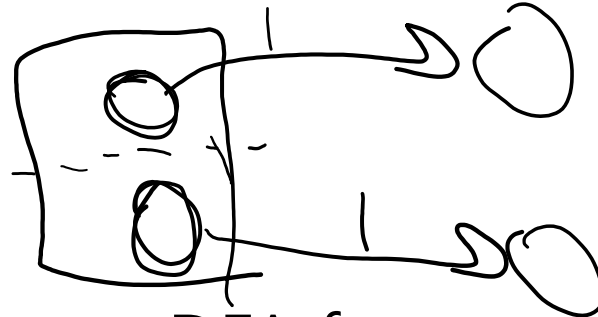

We can know!

Fun fact: there is a unique minimum DFA for every language (up to renaming the states)

High level idea – final states and non-final states must be different.

Otherwise, hope that states can be the same, and iteratively separate when they have to go to different spots.

Some quarters this covered in detail. But...we ran out of time.

Optional slides – won't be required in HW or final but you might find it useful/interesting for your own learning.

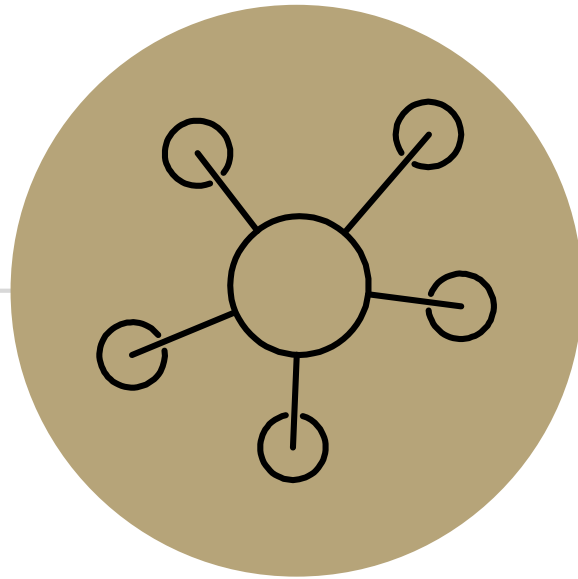

Machines With Output

Adding Output to Finite State Machines

So far we have considered finite state machines that just accept/reject strings

called "Deterministic Finite Automata" or DFAs

{ Now we consider finite state machines that with output
{ These are often used as controllers



Vending Machine



Enter 15 cents in dimes or nickels
Press S or B for a candy bar



Vending Machine v0.1

Vending Machine, v0.1

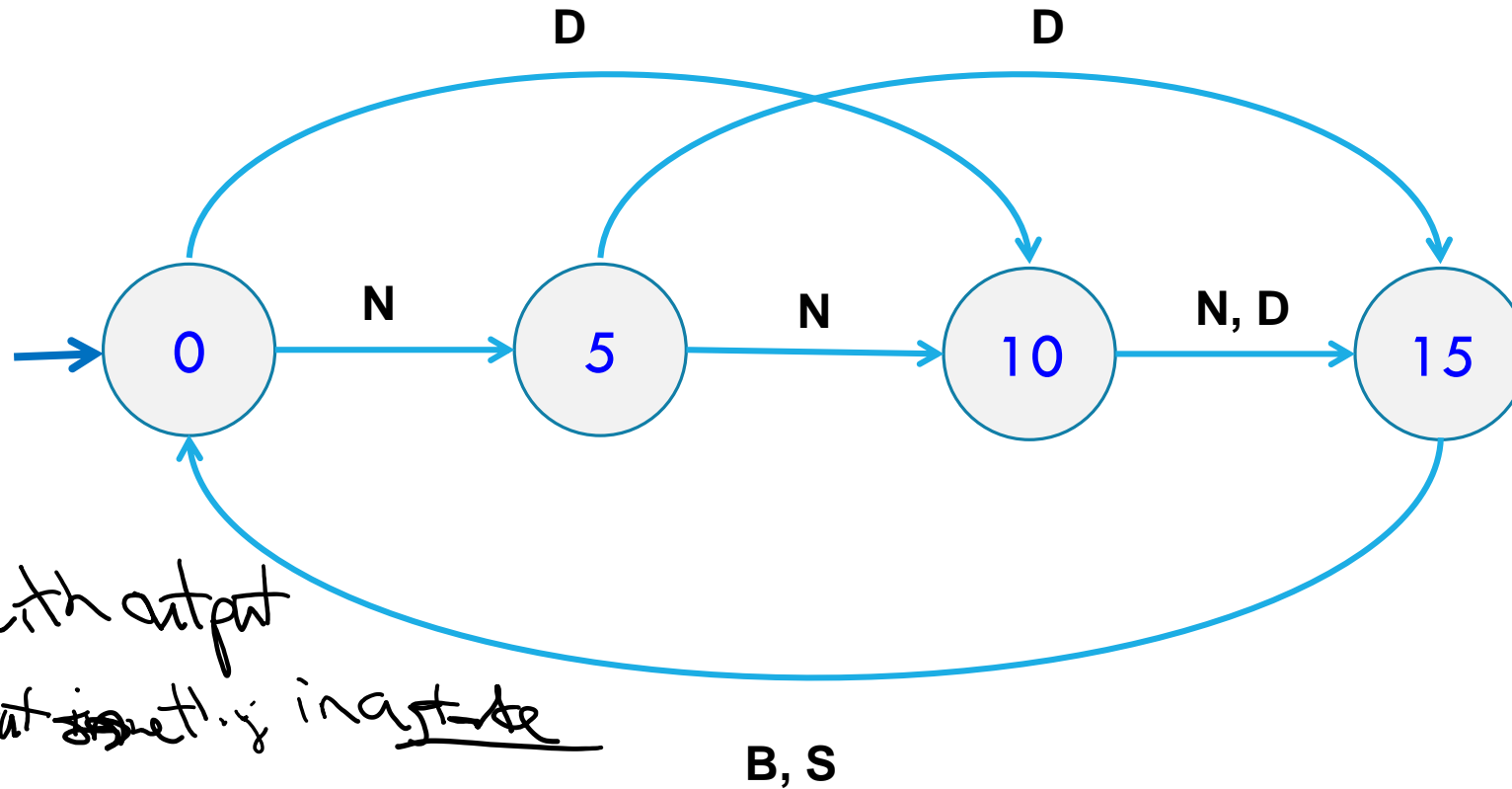

*machines with output
add output ~~isn't~~ in state*

[B]

Basic transitions on **N** (nickel), **D** (dime), **B** (butterfinger), **S** (snickers)

Vending Machine v0.2

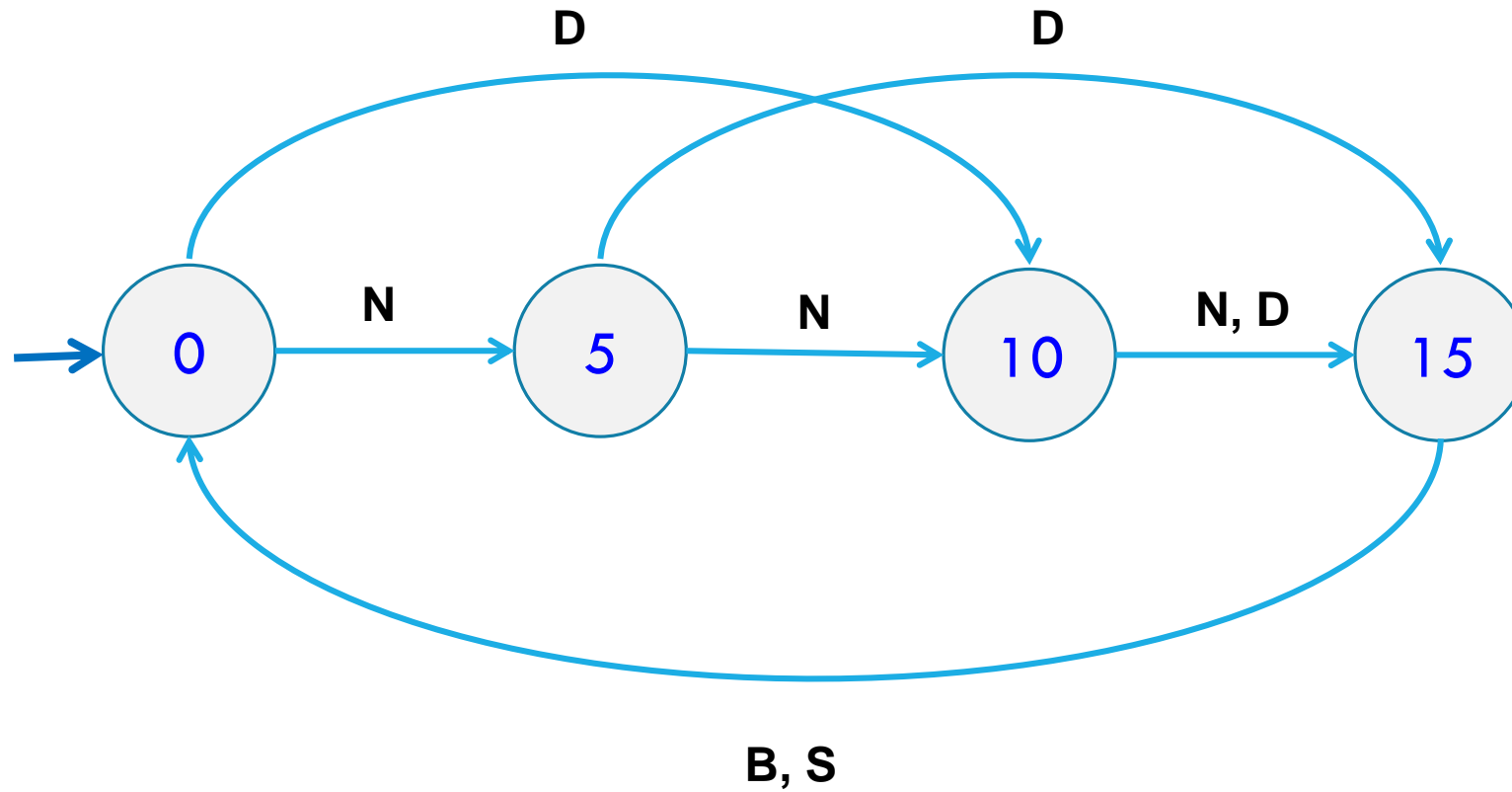

Vending Machine, v0.2

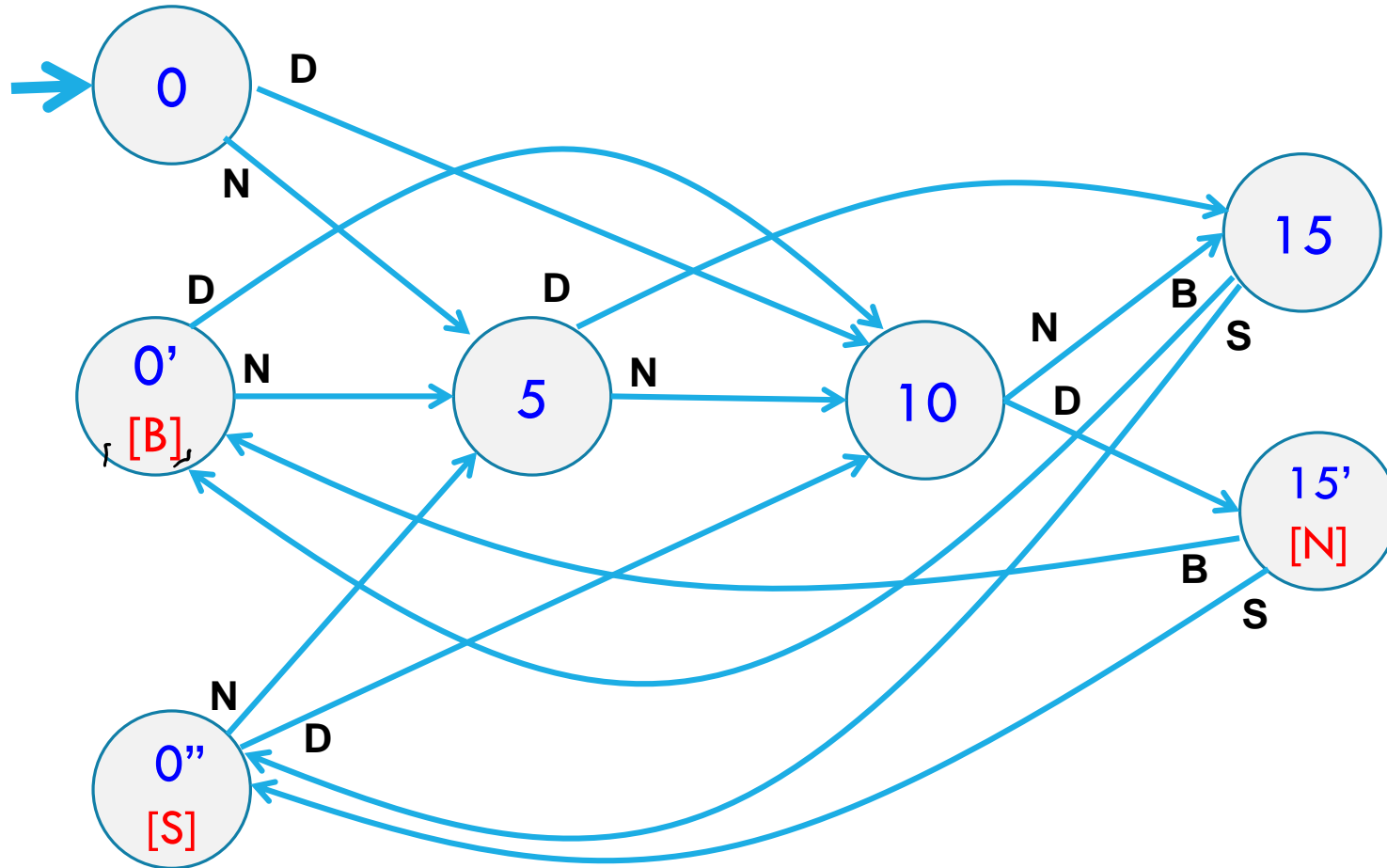

Adding output to states: **N** – Nickel, **S** – Snickers, **B** – Butterfinger

Vending Machine, v1.0

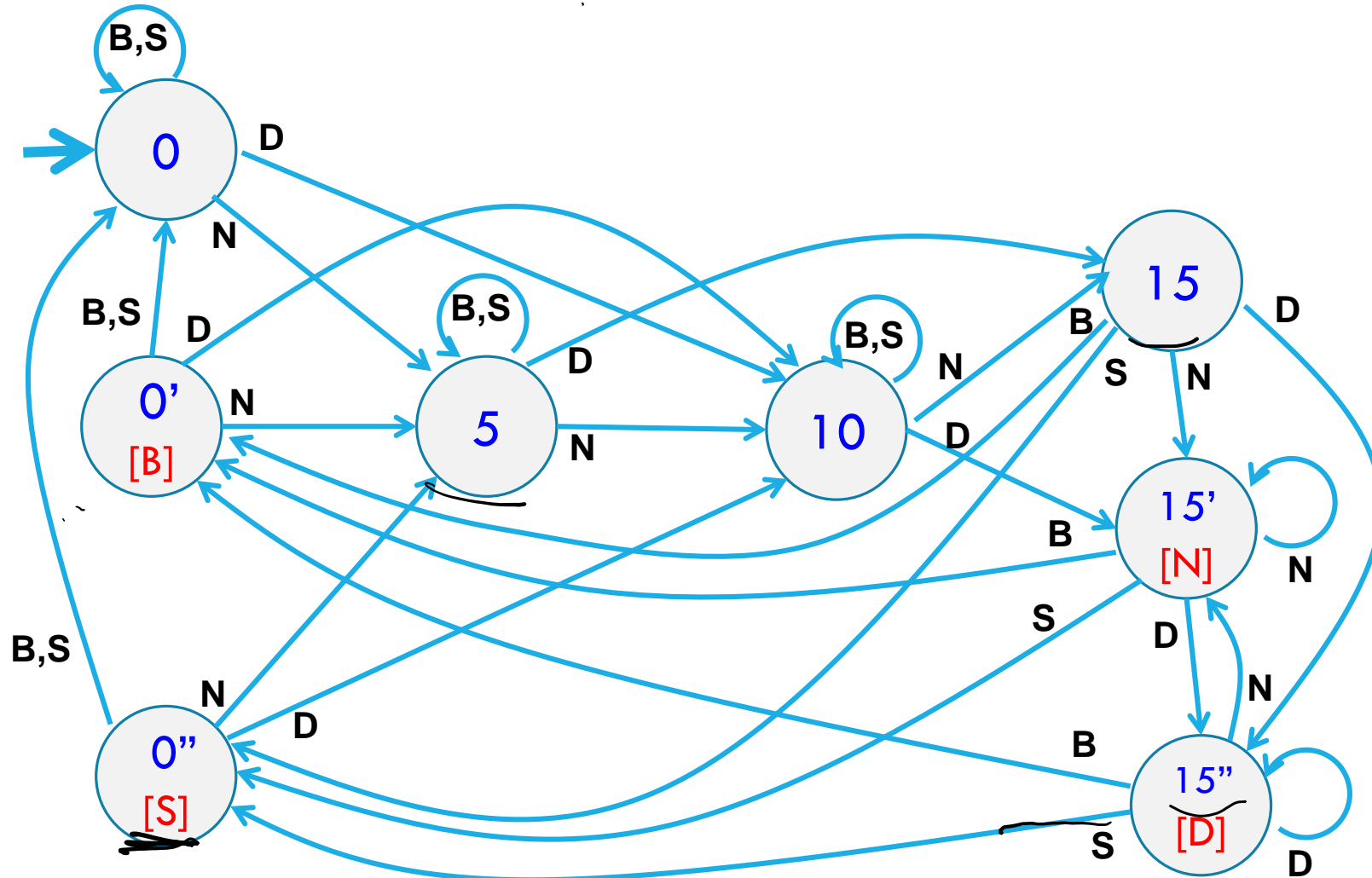

Adding additional “unexpected” transitions to cover all symbols for each state

What are FSMs used for?

“Classic” hardware applications:

Anything where you only need to remember a very small amount of information, and have very simple update rules.

Vending machines

Elevators: need to know whether you’re going up or down, where people want to go, where people are waiting, and whether you’re going up or down. Simple rules to transition.

These days...general hardware is cheap, less likely to use custom hardware. BUT the programmer was probably still thinking about FSMs when writing the code.

What are FSMs used for?

Theoretically – still lots of applications.

`grep` uses FSMs to analyze regular expressions (more on this later).

Useful for modeling situations where you have minimal memory.

Good model for simple AI (say simple NPCs in games).

Technically all of our computers are finite state machines...
But they're not usually how we think about them...more on this next week.

Let's try to make our more powerful automata

We're going to get rid of some of the restrictions on DFAs, to see if we can get more powerful machines (i.e. can recognize more languages).

From a given state, we'll allow any number of outgoing edges labeled with a given character. The machine can follow any of them.

We'll have edges labeled with " ϵ " – the machine (optionally) can follow one of those without reading another character from the input.

If we "get stuck" i.e. the next character is a and there's no transition leaving our state labeled a , the computation dies.

Nondeterministic Finite Automata

An NFA:

Still has exactly one start state and any number of final states.

The NFA accepts x if there is some path from a start state to a final state labeled with x .



"all binary strings containing 111"

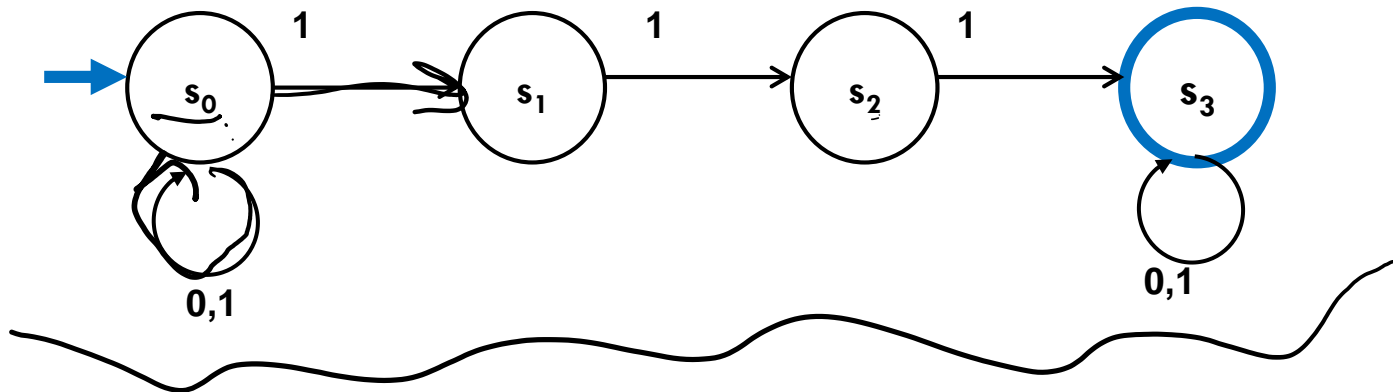

Wait a second...

But...how does it know?

Is this realistic?

Three ways to think about NFAs

“Outside Observer”: is there a path labeled by x from the start state, to the final state (if we know the input in advance can we tell the NFA which decisions to make)

“Perfect Guesser”: The NFA has input x , and whenever there is a choice of what to do, it **magically** guesses a transition that will eventually lead to acceptance (if one exists)

“Parallel exploration”: The NFA computation runs all possible computations on x in parallel (updating each possible one at every step)

So...magic guessing doesn't exist

I know.

The parallel computation view is realistic.

Lets us give simpler descriptions of complicated objects.

This notion of "nondeterminism" is also really useful in more advanced CS theory (you'll see it again in 421 or 431 if not sooner).

Source of the P vs. NP problem.

NFA practice

What is the language of this NFA?

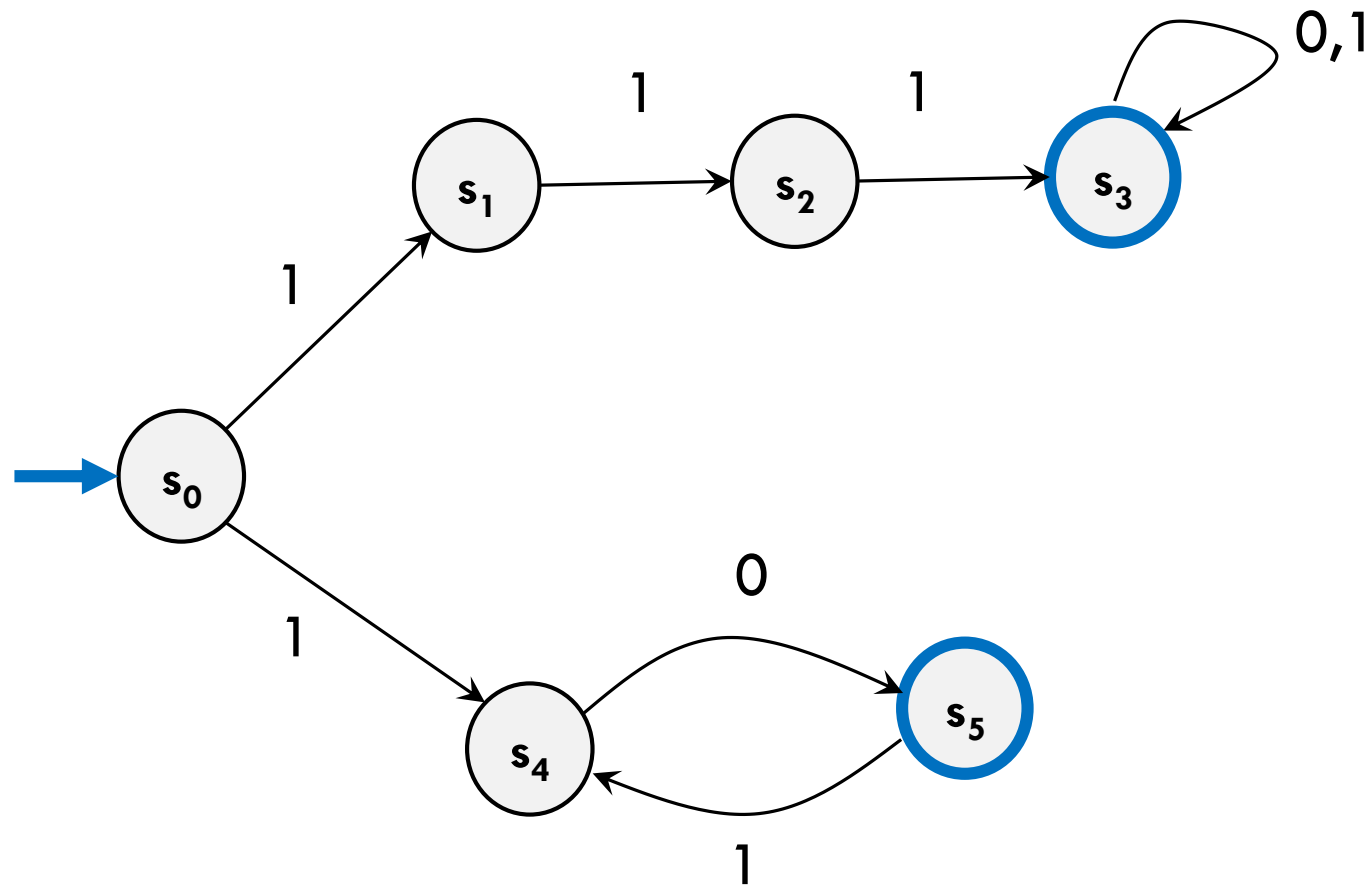

NFA practice

What is the language of this NFA?

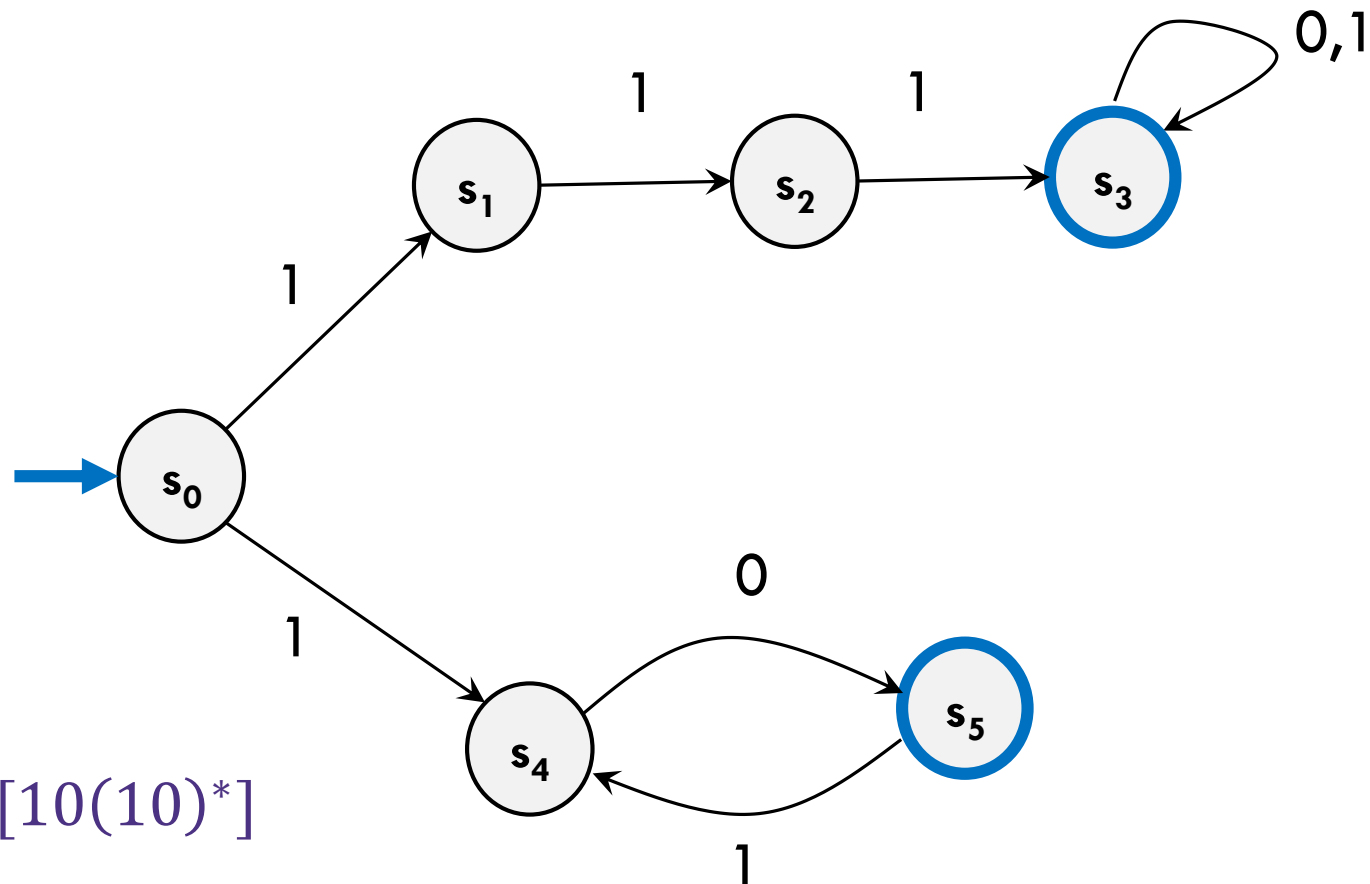

$111(0 \cup 1)^*$

$10(10)^*$

Overall
 $[111(0 \cup 1)^*] \cup [10(10)^*]$

What about those ε -transitions?

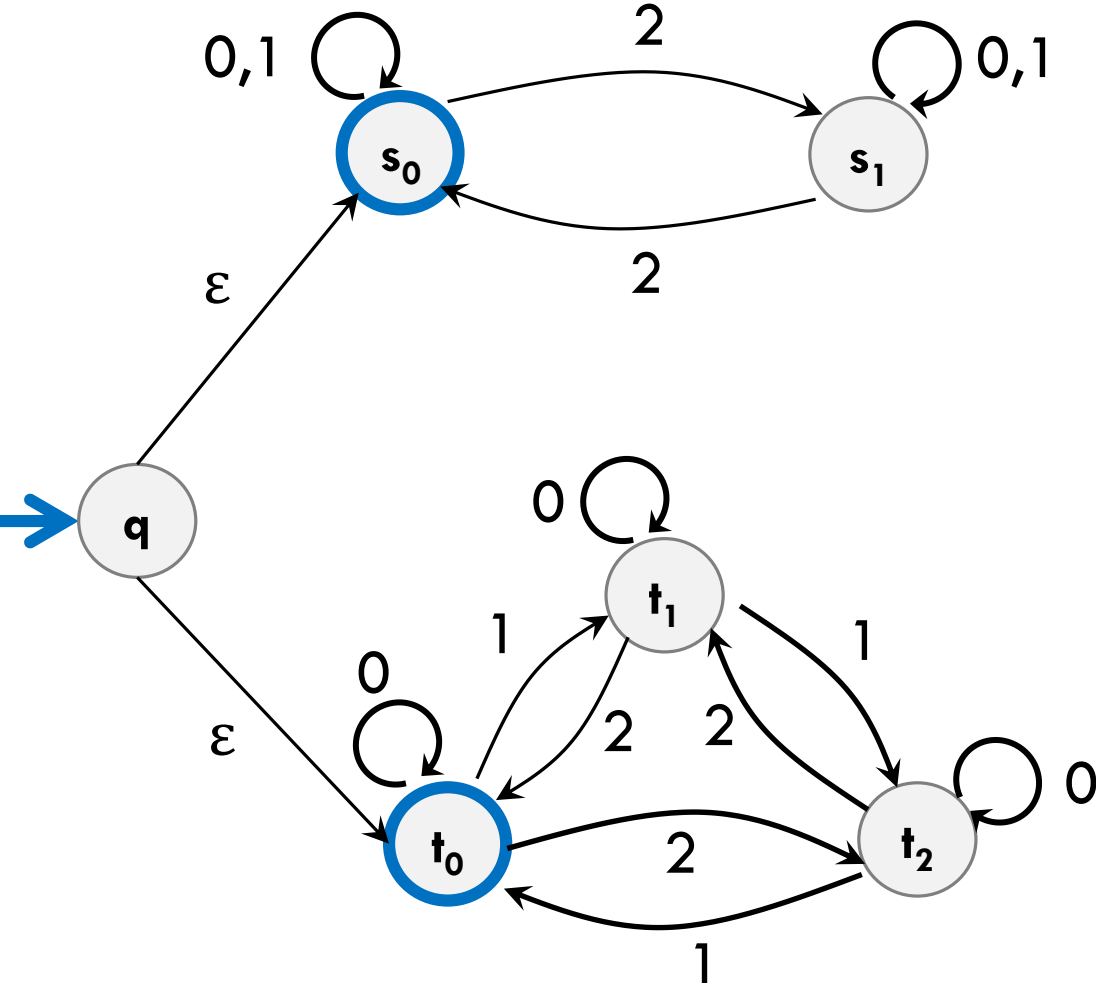

What about those ε -transitions?

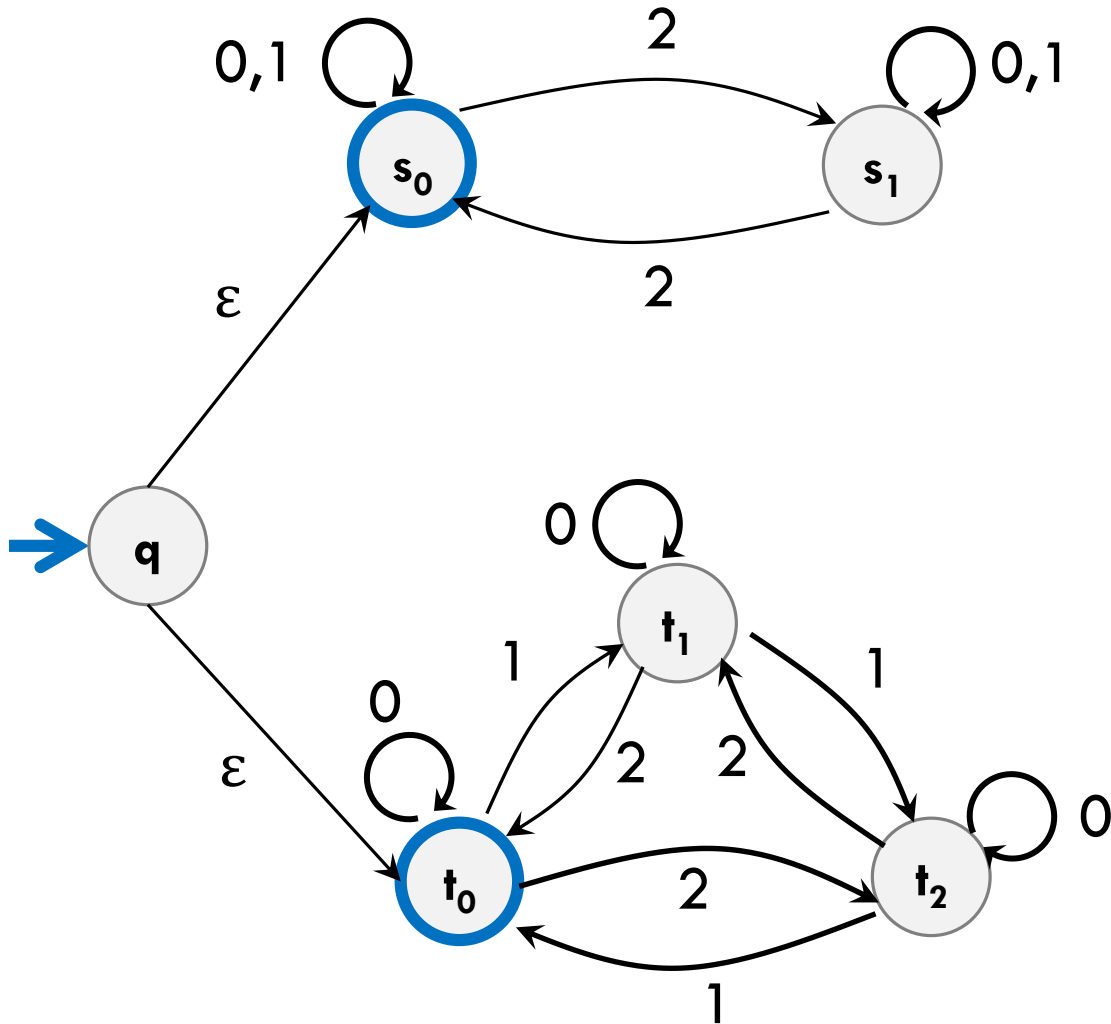

The set of strings over $\{0,1,2\}$ with an even number of 2's or the sum $\%3 = 0$.

NFA that recognizes "binary strings with a 1 in the third position from the end"

"Perfect Guesser": The NFA has input x , and whenever there is a choice of what to do, it **magically** guesses a transition that will eventually lead to acceptance (if one exists)

Perfect guesser view makes this easier.

Design an NFA for the language in the title.

Fill out the poll everywhere for
Activity Credit!

Go to pollev.com/cse311 and login
with your UW identity

Or text cse311 to 22333

NFA that recognizes "binary strings with a 1 in the third position from the end"

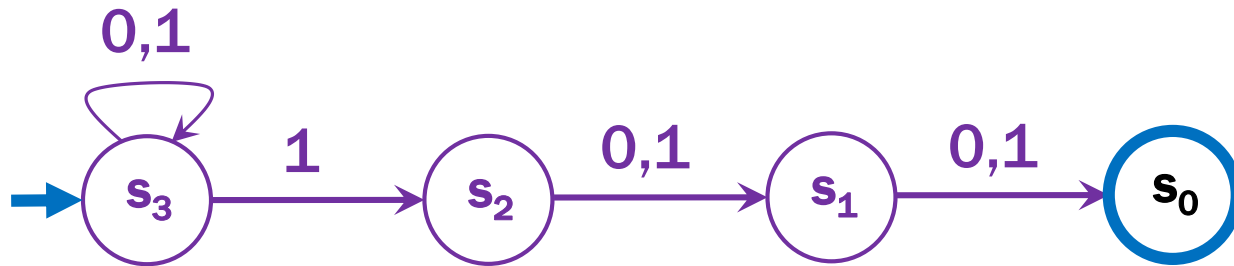

That's WAY easier than the DFA...

Parallel Exploration view of an NFA

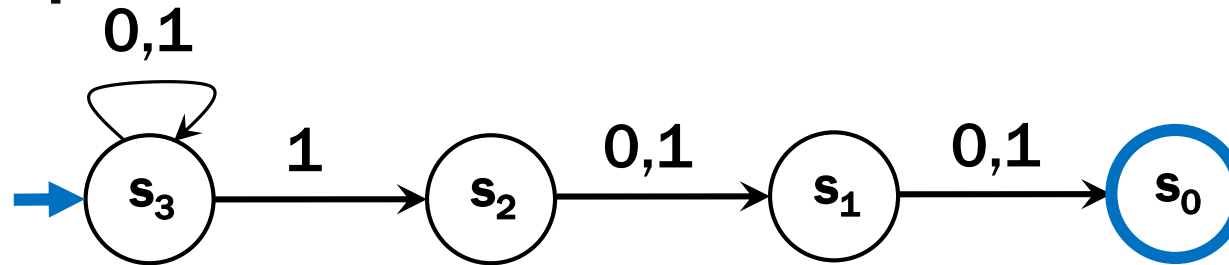

Input string 0101100

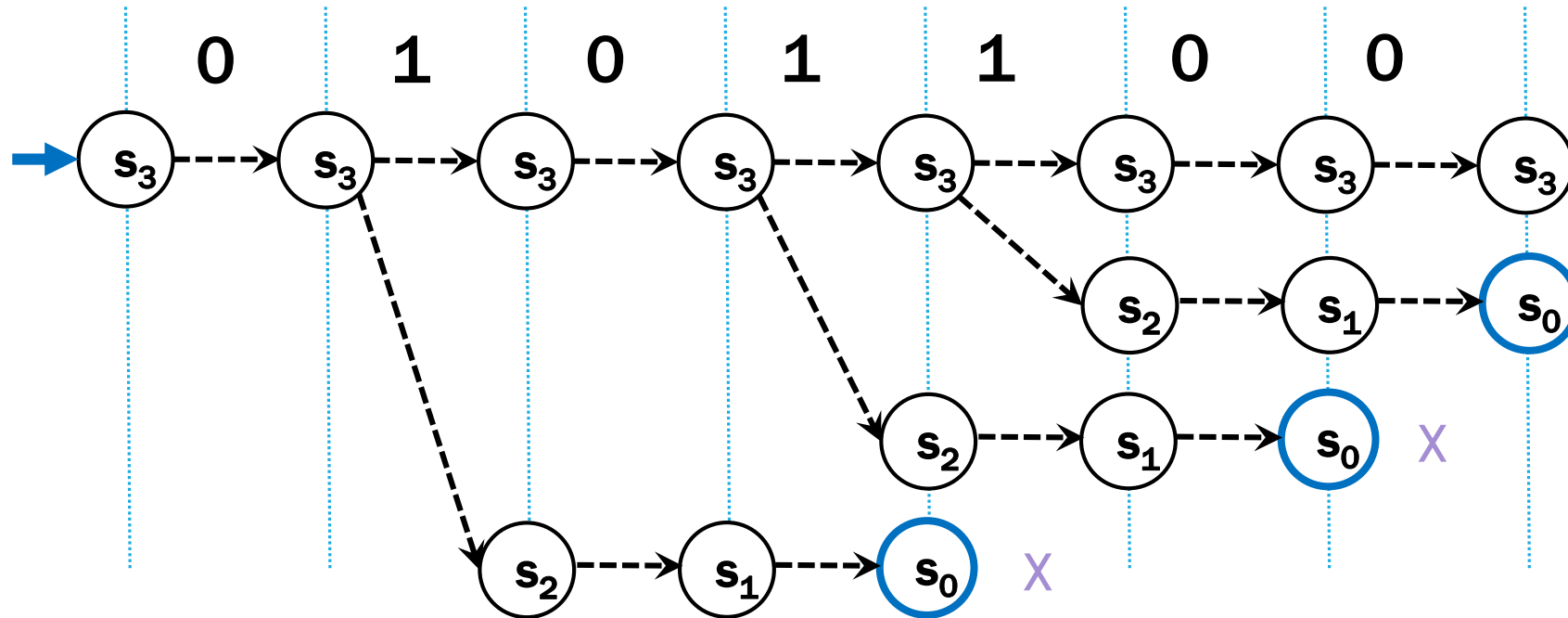

More NFA practice

Write an NFA for:

Strings over $\{0,1,2\}$ that contain at least three 0's.

Strings over $\{0,1,2\}$ where the number of 2's is even **and** the sum of the digits $\%3=0$.