

## 16. Projections and Z-buffers

1

## Reading

Required:

- ♦ Watt, Section 5.2.2 – 5.2.4, 6.3, 6.6 (esp. intro and subsections 1, 4, and 8–10),

Further reading:

- ♦ Foley, et al, Chapter 5.6 and Chapter 6
- ♦ David F. Rogers and J. Alan Adams, *Mathematical Elements for Computer Graphics*, 2<sup>nd</sup> Ed., McGraw-Hill, New York, 1990, Chapter 2.
- ♦ I. E. Sutherland, R. F. Sproull, and R. A. Schumacker, A characterization of ten hidden surface algorithms, *ACM Computing Surveys* 6(1): 1-55, March 1974.

2

## 3D Geometry Pipeline

Before being turned into pixels by graphics hardware, a piece of geometry goes through a number of transformations...

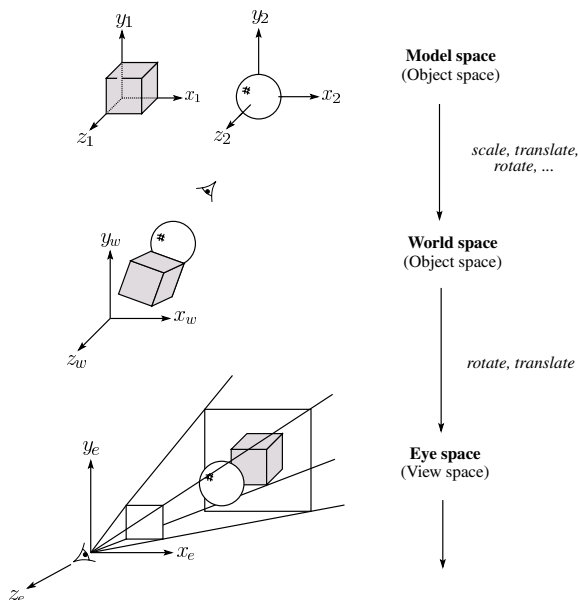

3

## 3D Geometry Pipeline (cont'd)

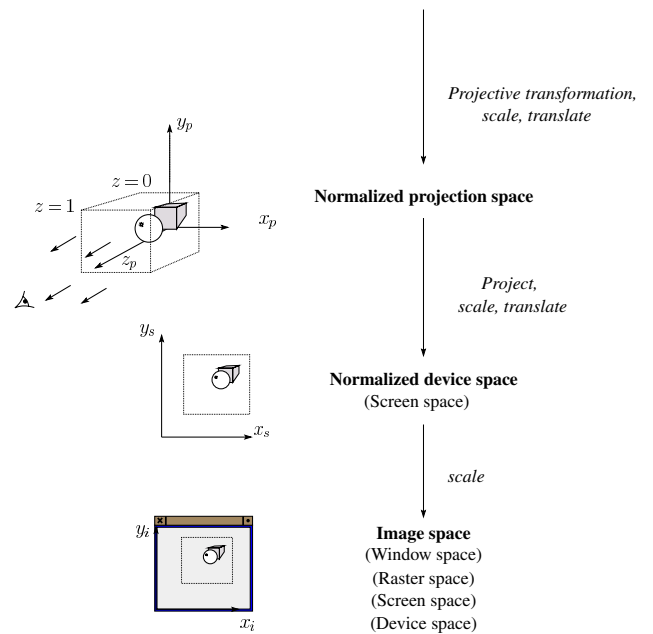

4

# Projections

**Projections** transform points in  $n$ -space to  $m$ -space, where  $m < n$ .

In 3-D, we map points from 3-space to the **projection plane** (PP) along **projectors** emanating from the **center of projection** (COP):

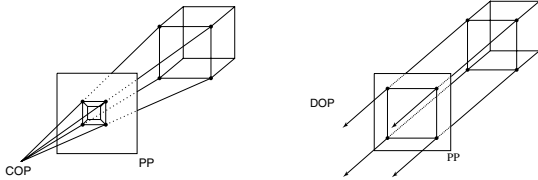

The center of projection is exactly the same as the pinhole in a pinhole camera.

There are two basic types of projections:

- ◆ Perspective – distance from COP to PP finite
- ◆ Parallel – distance from COP to PP infinite

# Parallel projections

For parallel projections, we specify a **direction of projection** (DOP) instead of a COP.

There are two types of parallel projections:

- ◆ **Orthographic projection** – DOP perpendicular to PP
- ◆ **Oblique projection** – DOP not perpendicular to PP

We can write orthographic projection onto the  $z=0$  plane with a simple matrix.

$$\begin{bmatrix} x' \\ y' \\ 1 \end{bmatrix} = \begin{bmatrix} 1 & 0 & 0 & 0 \\ 0 & 1 & 0 & 0 \\ 0 & 0 & 0 & 1 \end{bmatrix} \begin{bmatrix} x \\ y \\ z \\ 1 \end{bmatrix}$$

Normally, we do not drop the  $z$  value right away. Why not?

# Properties of parallel projection

Properties of parallel projection:

- ◆ Not realistic looking
- ◆ Good for exact measurements
- ◆ Are actually a kind of affine transformation
  - Parallel lines remain parallel
  - Angles not (in general) preserved
- ◆ Most often used in CAD, architectural drawings, etc., where taking exact measurement is important

# Derivation of perspective projection

Consider the projection of a point onto the projection plane:

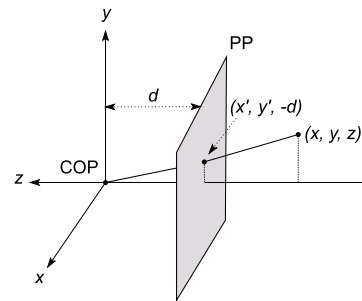

By similar triangles, we can compute how much the  $x$  and  $y$  coordinates are scaled:

[Note: Watt uses a left-handed coordinate system, and he looks down the  $+z$  axis, so his PP is at  $+d$ .]

## Homogeneous coordinates revisited

Remember how we said that affine transformations work with the last coordinate always set to one.

What happens if the coordinate is not one?

We divide all the coordinates by  $w$ :

$$\begin{bmatrix} x \\ y \\ z \\ w \end{bmatrix} \rightarrow \begin{bmatrix} x/w \\ y/w \\ z/w \\ 1 \end{bmatrix}$$

If  $w = 1$ , then nothing changes.

Sometimes we call this division step the "perspective divide."

9

## Homogeneous coordinates and perspective projection

Now we can re-write the perspective projection as a matrix equation:

$$\begin{bmatrix} x' \\ y' \\ w' \end{bmatrix} = \begin{bmatrix} 1 & 0 & 0 & 0 \\ 0 & 1 & 0 & 0 \\ 0 & 0 & -1/d & 0 \end{bmatrix} \begin{bmatrix} x \\ y \\ z \\ w \end{bmatrix} = \begin{bmatrix} x \\ y \\ -z/d \end{bmatrix}$$

After division by  $w$ , we get:

$$\begin{bmatrix} x' \\ y' \\ 1 \end{bmatrix} = \begin{bmatrix} -x/d \\ -y/d \\ z \end{bmatrix}$$

Again, projection implies dropping the  $z$  coordinate to give a 2D image, but we usually keep it around a little while longer.

10

## Projective normalization

After applying the perspective transformation and dividing by  $w$ , we are free to do a simple parallel projection to get the 2D image.

What does this imply about the shape of things after the perspective transformation + divide?

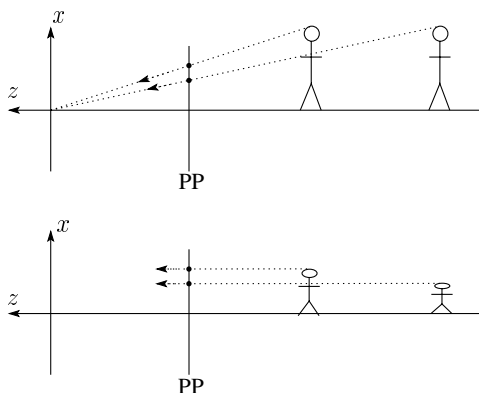

11

## Vanishing points

What happens to two parallel lines that are not parallel to the projection plane?

Think of train tracks receding into the horizon...

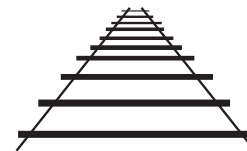

The equation for a line is:

$$\mathbf{l} = \mathbf{p} + t\mathbf{v} = \begin{bmatrix} p_x \\ p_y \\ p_z \\ 1 \end{bmatrix} + t \begin{bmatrix} v_x \\ v_y \\ v_z \\ 0 \end{bmatrix}$$

After perspective transformation we get:

$$\begin{bmatrix} x' \\ y' \\ w' \end{bmatrix} = \begin{bmatrix} p_x + tv_x \\ p_y + tv_y \\ -(p_z + tv_z)/d \end{bmatrix}$$

12

## Vanishing points (cont'd)

Dividing by  $w$ :

$$\begin{bmatrix} x' \\ y' \\ w' \end{bmatrix} = \begin{bmatrix} -\frac{p_x + tv_x}{p_z + tv_z} d \\ -\frac{p_y + tv_y}{p_z + tv_z} d \\ 1 \end{bmatrix}$$

Letting  $t$  go to infinity:

We get a point!

What happens to the line  $\mathbf{l} = \mathbf{q} + t\mathbf{v}$ ?

Each set of parallel lines intersect at a **vanishing point** on the PP.

**Q:** How many vanishing points are there?

13

## Properties of perspective projections

The perspective projection is an example of a **projective transformation**.

Here are some properties of projective transformations:

- ◆ Lines map to lines
- ◆ Parallel lines do not necessarily remain parallel
- ◆ Ratios are not preserved

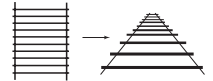

One of the advantages of perspective projection is that size varies inversely with distance – looks realistic.

A disadvantage is that we can't judge distances as exactly as we can with parallel projections.

**Q:** Why did nature give us eyes that perform perspective projections?

**Q:** Do our eyes “see in 3D”?

14

## Z-buffer

We can use projections for **hidden surface elimination**.

The **Z-buffer'** or **depth buffer** algorithm [Catmull, 1974] is probably the simplest and most widely used of these techniques.

Here is pseudocode for the Z-buffer hidden surface algorithm:

```
for each pixel  $(i,j)$  do
  Z-buffer  $[i,j] \leftarrow FAR$ 
  Framebuffer  $[i,j] \leftarrow \langle \text{background color} \rangle$ 
end for
for each polygon  $A$  do
  for each pixel in  $A$  do
    Compute depth  $z$  and shade  $s$  of  $A$  at  $(i,j)$ 
    if  $z > Z\text{-buffer}[i,j]$  then
      Z-buffer  $[i,j] \leftarrow z$ 
      Framebuffer  $[i,j] \leftarrow s$ 
    end if
  end for
end for
```

15

## Gouraud vs. Phong interpolation

Does graphics hardware do a full shading calculation at every point? Not commonly, but this is changing...

Smooth surfaces are often approximated by polygonal facets, because:

- ◆ Graphics hardware generally wants polygons (esp. triangles).
- ◆ Sometimes it easier to write ray-surface intersection algorithms for polygonal models.

How do we compute the shading for such a surface?

16

## Faceted shading

Assume each face has a constant normal:

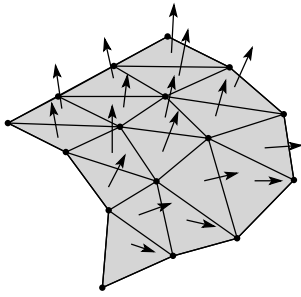

For a distant viewer and a distant light source, how will the color of each triangle vary?

Result: faceted, not smooth, appearance.

17

## Gouraud interpolation

To get a smoother result that is easily performed in hardware, we can do **Gouraud interpolation**.

Here's how it works:

1. Compute normals at the vertices.
2. Shade only the vertices.
3. Interpolate the resulting vertex colors.

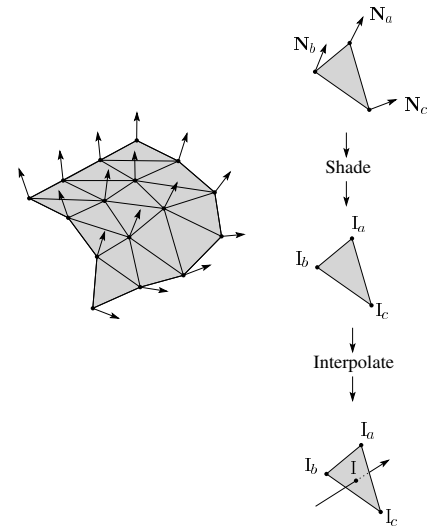

18

## Gouraud interpolation, cont'd

Gouraud interpolation has significant limitations.

1. If the polygonal approximation is too coarse, we can miss specular highlights.

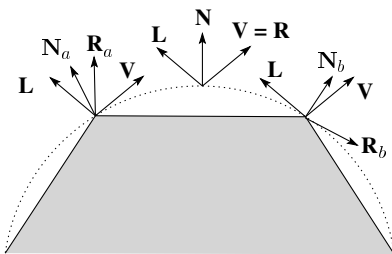

2. We will encounter **Mach banding** (derivative discontinuity enhanced by human eye).

Alas, this is usually what graphics hardware supports.

Maybe someday soon all graphics hardware will do...

19

## Phong interpolation

To get an even smoother result with fewer artifacts, we can perform **Phong interpolation**.

Here's how it works:

1. Compute normals at the vertices.
2. Interpolate normals and normalize.
3. Shade using the interpolated normals.

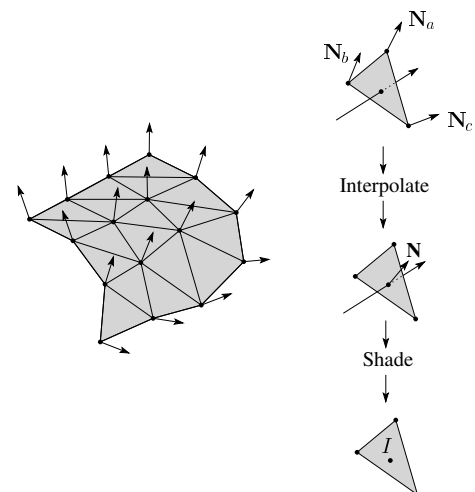

20

## Z-buffer, cont'd

The process of filling in the pixels inside of a polygon is called **rasterization**.

During rasterization, the z value and shade  $s$  can be computed incrementally (fast!).

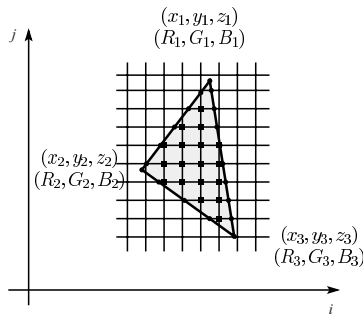

### Curious fact:

- Described as the “brute-force image space algorithm” by [SSS]
- Mentioned only in Appendix B of [SSS] as a point of comparison for huge memories, but written off as totally impractical.

Today, Z-buffers are commonly implemented in hardware.

21

## Texture mapping and the z-buffer

Texture-mapping can also be handled in z-buffer algorithms.

### Method:

- Scan conversion is done in screen space, as usual
- Each pixel is colored according to the texture
- Texture coordinates are found by Gouraud-style interpolation

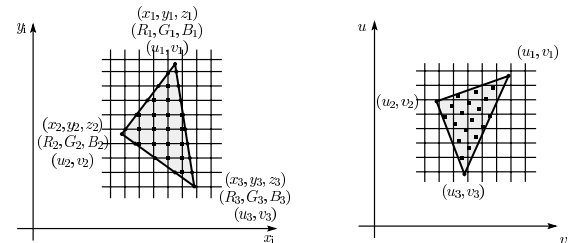

**Note:** Mapping is more complicated if you want to do perspective right!

22

## Visibility tricks for Z-buffers

Z-buffering is **the** algorithm of choice for hardware rendering, so let's think about how to make it run as fast as possible...

What is the cost of the Z-buffer algorithm?

What can we do to decrease the constants?

23