

Lecture 16: Reinforcement Learning

Administrative

Grades:

A3 due tonight!

So far... Supervised Learning

Data: (x, y)

x is data, y is label

Goal: Learn a *function* to map $x \rightarrow y$

Examples: Classification,
regression, object detection,
semantic segmentation, image
captioning, etc.



→ Cat

Classification

[This image is CC0 public domain](#)

So far... Self-supervised Learning

Data: x

Just data, no labels!

Goal: Define proxy tasks to uncover useful representations from the data

Examples: SimCLR, MoCo, Dino, etc.

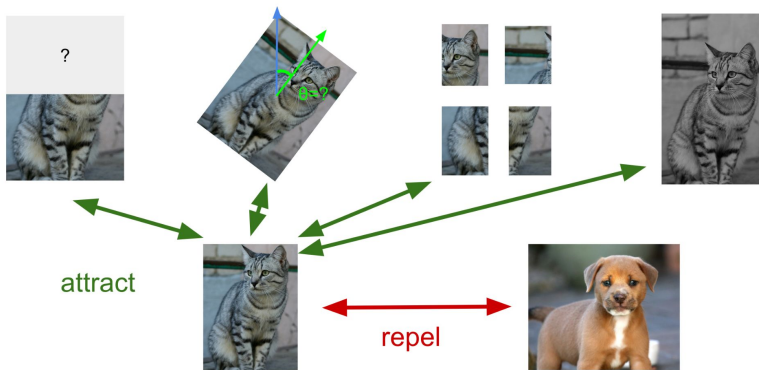

2-d density images [left](#) and [right](#) are [CC0 public domain](#)

From passive images of active observations: Embodied AI



Overhead view of photo-realistic
synthetic environments

What an agent sees

Deitke et al. "ProcTHOR: Large-Scale Embodied AI Using Procedural Generation" NeurIPS 2022

From object recognition to object manipulation: Embodied AI

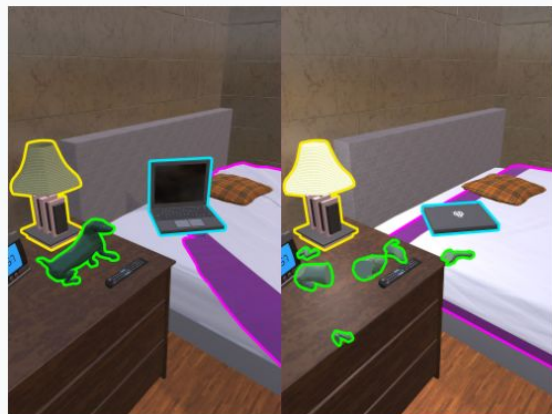

Objects in 3D spaces



Manipulating objects



Multi-agent collaboration

Deitke et al. "ProcrTHOR: Large-Scale Embodied AI Using Procedural Generation" NeurIPS 2022

Today: Reinforcement Learning

Problems involving an **agent** interacting with an **environment**, which provides numeric **reward** signals

Goal: Learn how to take actions in order to maximize reward



Atari games figure copyright Volodymyr Mnih et al., 2013. Reproduced with permission.

Overview

- What is Reinforcement Learning?
- Markov Decision Processes
- Q-Learning
- Policy Gradients

Reinforcement Learning

Agent

Environment

Reinforcement Learning

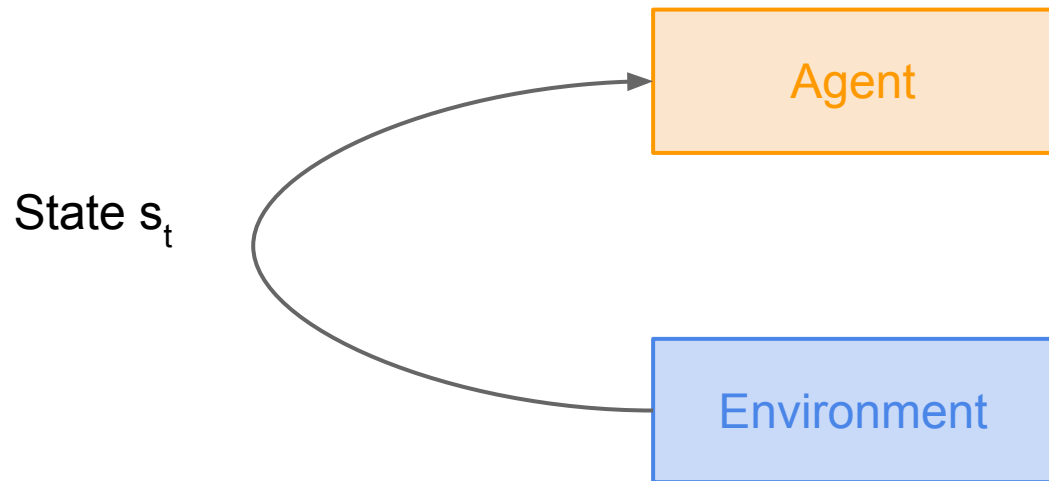

Reinforcement Learning

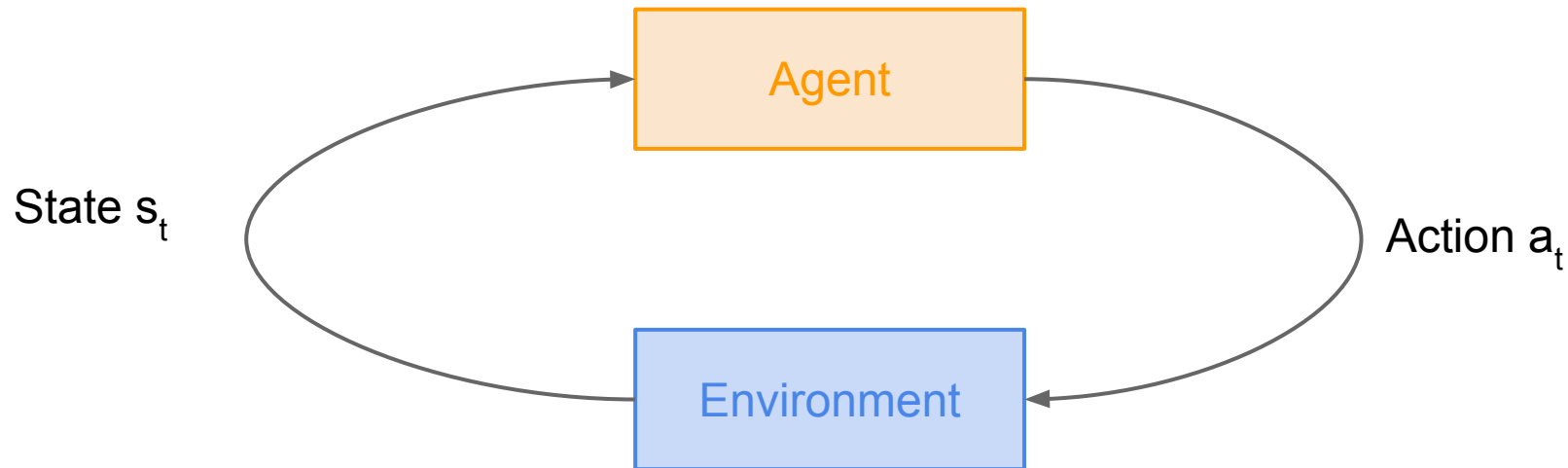

Reinforcement Learning

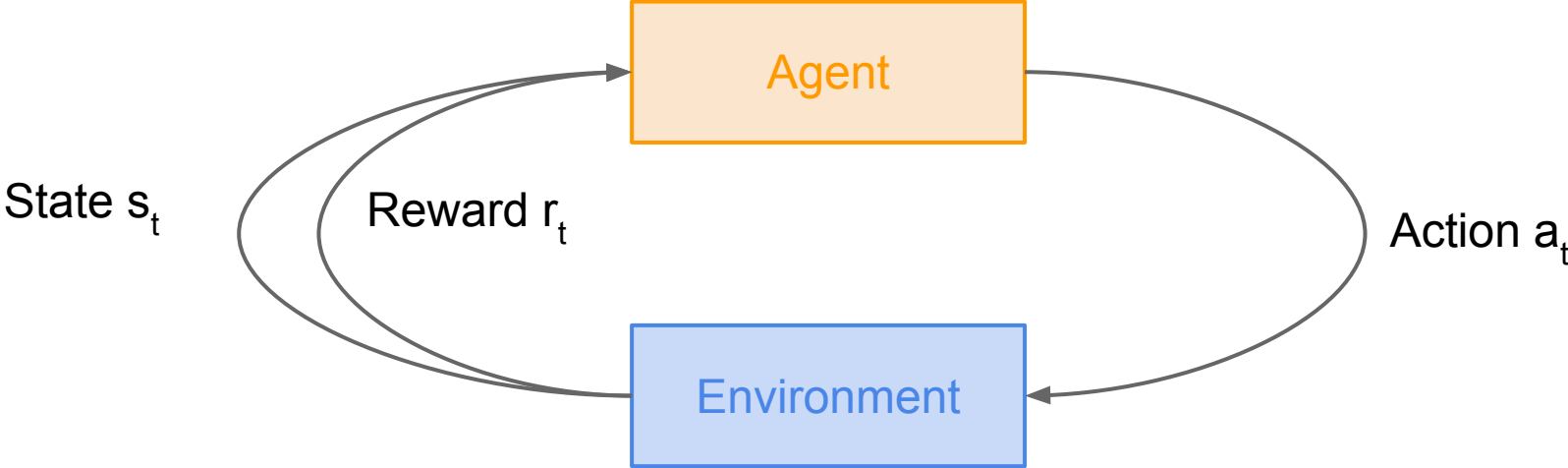

Reinforcement Learning

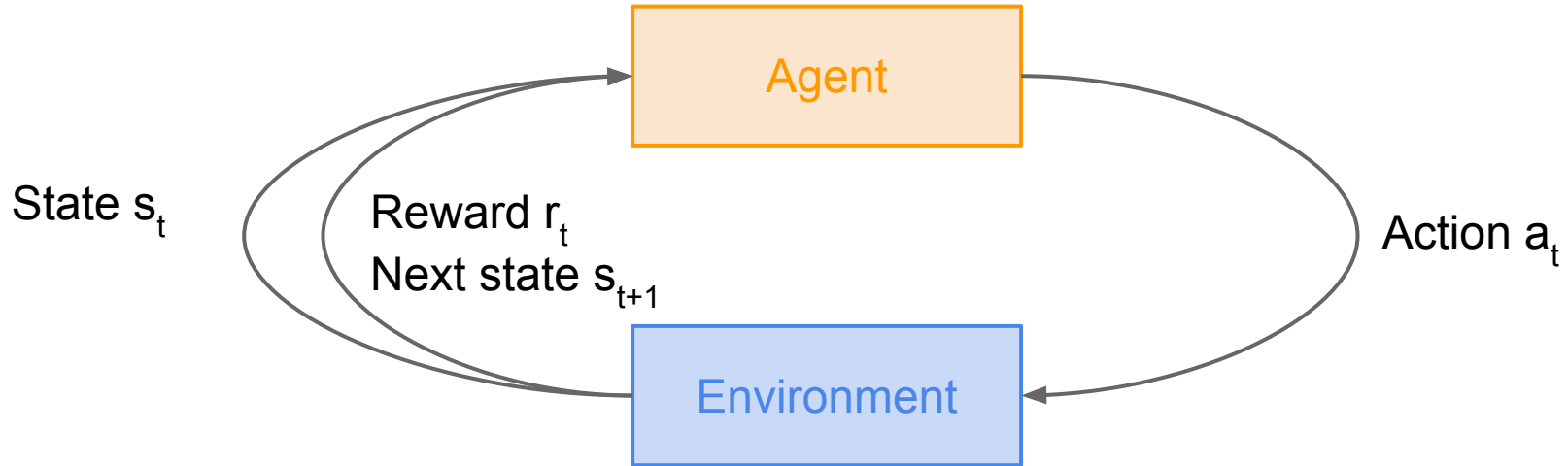

Cart-Pole Problem

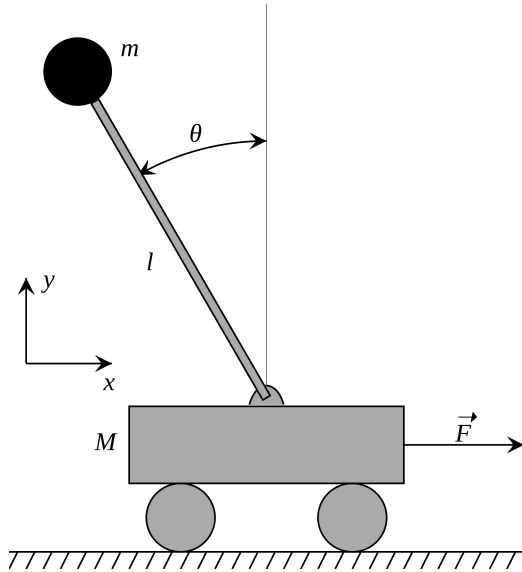

Objective: Balance a pole on top of a movable cart

State: angle, angular speed, position, horizontal velocity

Action: horizontal force applied on the cart

Reward: 1 at each time step if the pole is upright

[This image is CC0 public domain](#)

Robot Locomotion

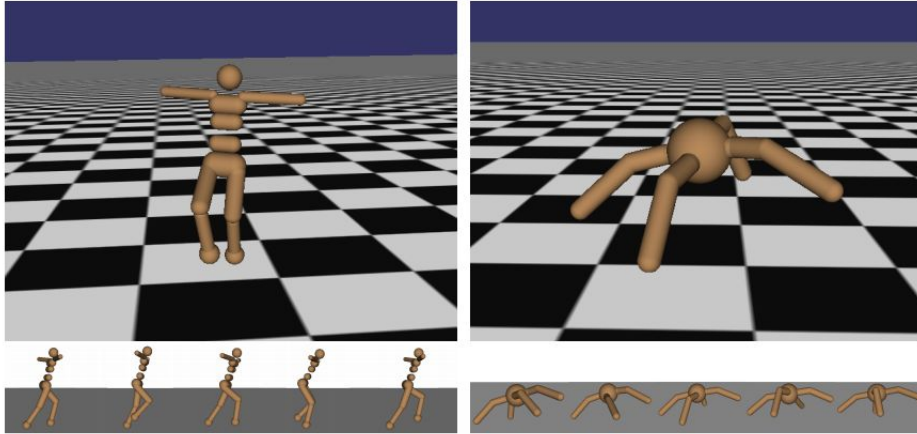

Objective: Make the robot move forward

State: Angle and position of the joints

Action: Torques applied on joints

Reward: 1 at each time step upright + forward movement

Figures copyright John Schulman et al., 2016. Reproduced with permission.

Atari Games



Objective: Complete the game with the highest score

State: Raw pixel inputs of the game state

Action: Game controls e.g. Left, Right, Up, Down

Reward: Score increase/decrease at each time step

Figures copyright Volodymyr Mnih et al., 2013. Reproduced with permission.

Go

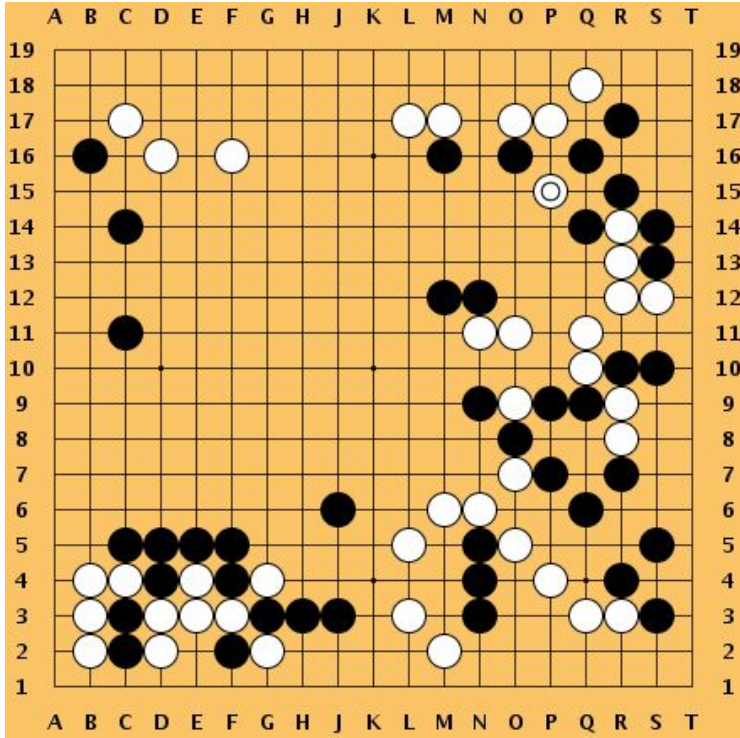

Objective: Win the game!

State: Position of all pieces

Action: Where to put the next piece down

Reward: 1 if win at the end of the game, 0 otherwise

[This image is CC0 public domain](#)

Reinforcement Learning vs Supervised Learning

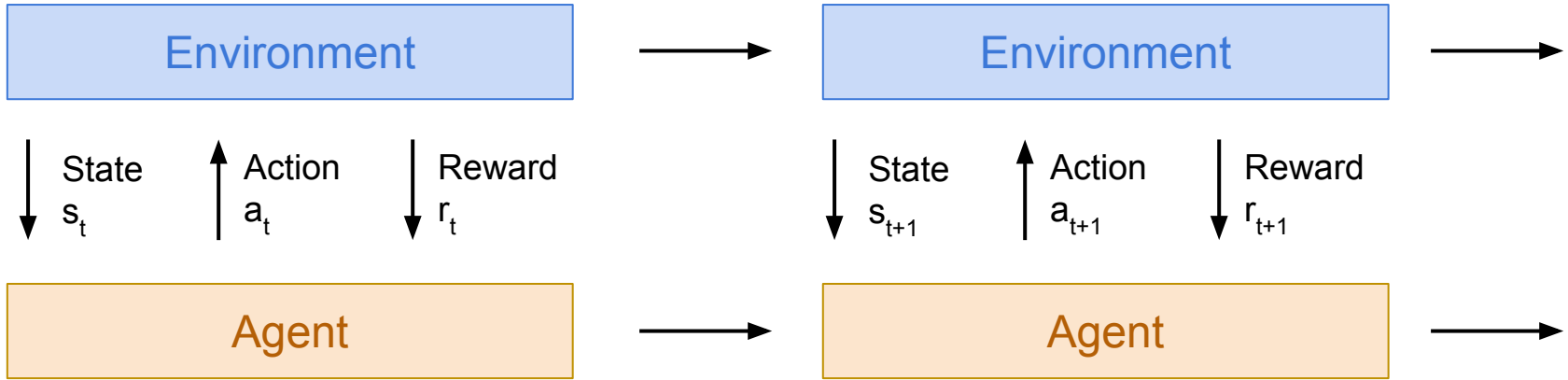

Reinforcement Learning vs Supervised Learning

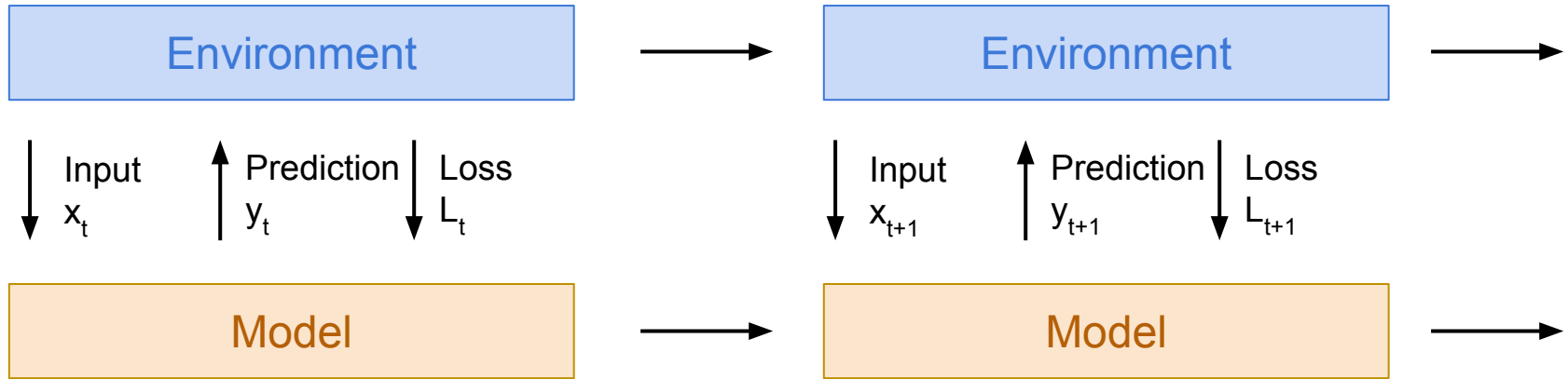

Why is supervised learning different from reinforcement learning?

Reinforcement Learning vs Supervised Learning

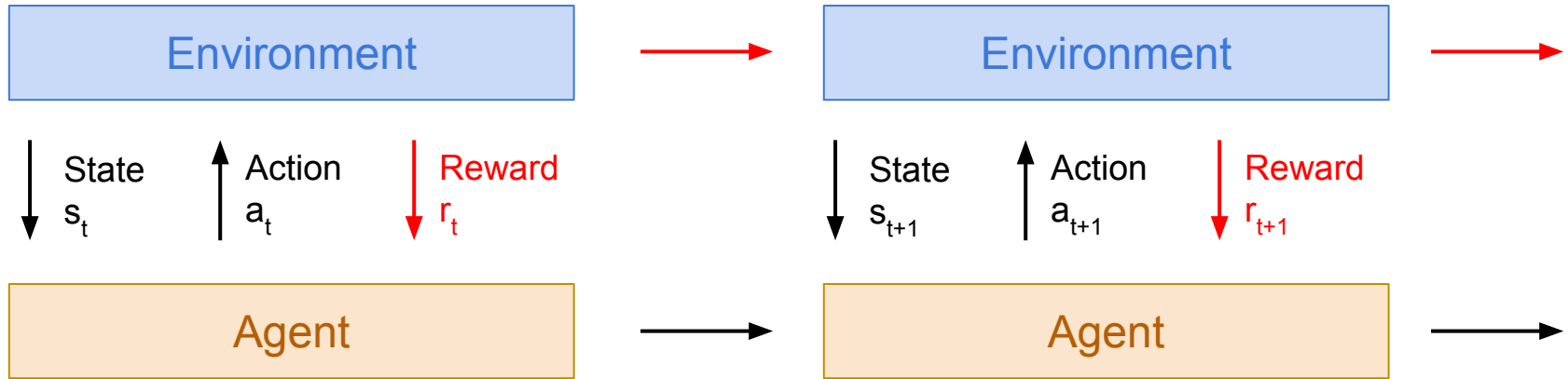

Stochasticity: Rewards and state transitions may be random

Reinforcement Learning vs Supervised Learning

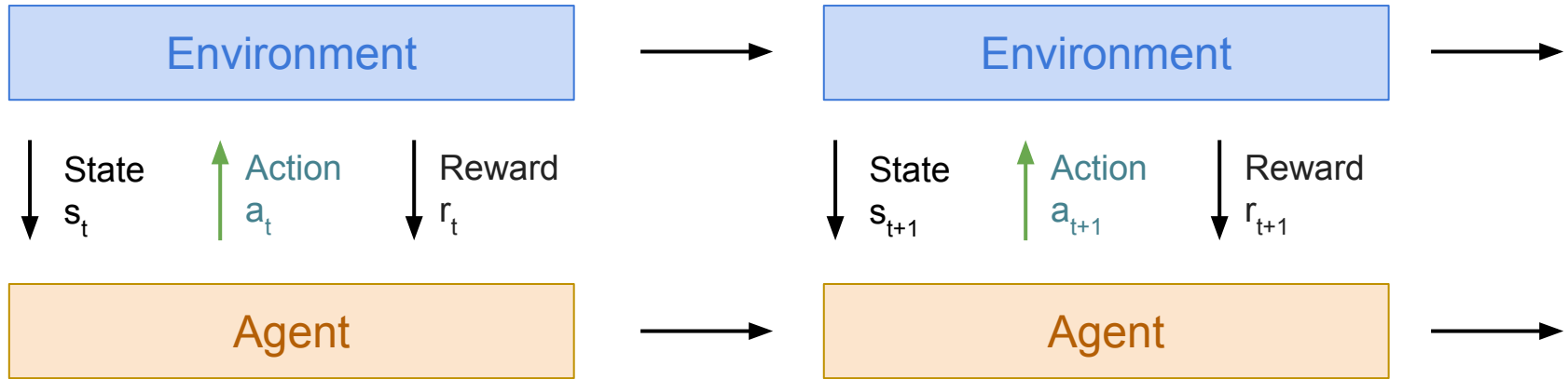

Credit assignment: Reward r_t may not directly depend on action a_t

Reinforcement Learning vs Supervised Learning

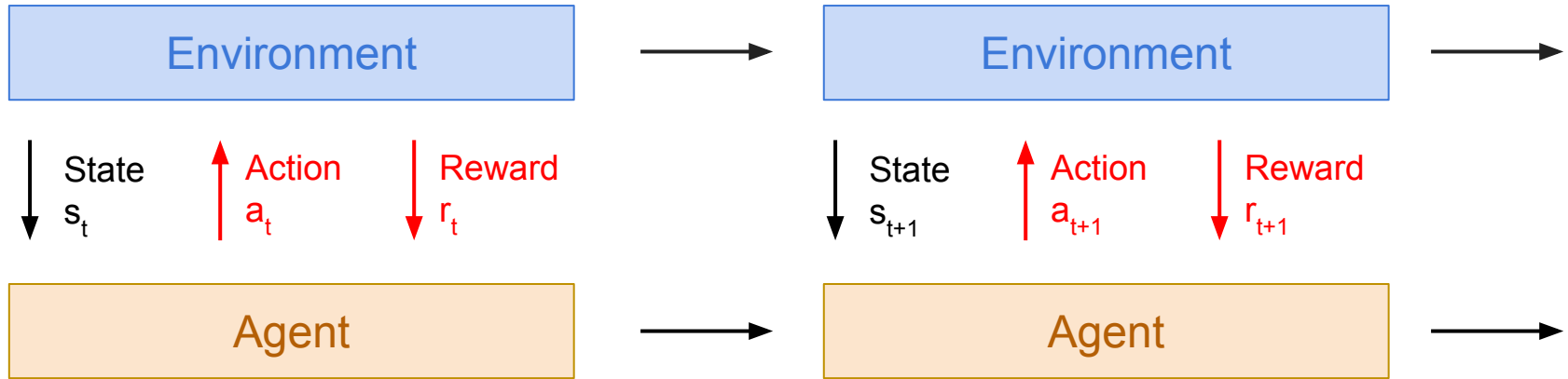

Nondifferentiable: Can't backprop through world; can't compute dr_t/da_t

Reinforcement Learning vs Supervised Learning

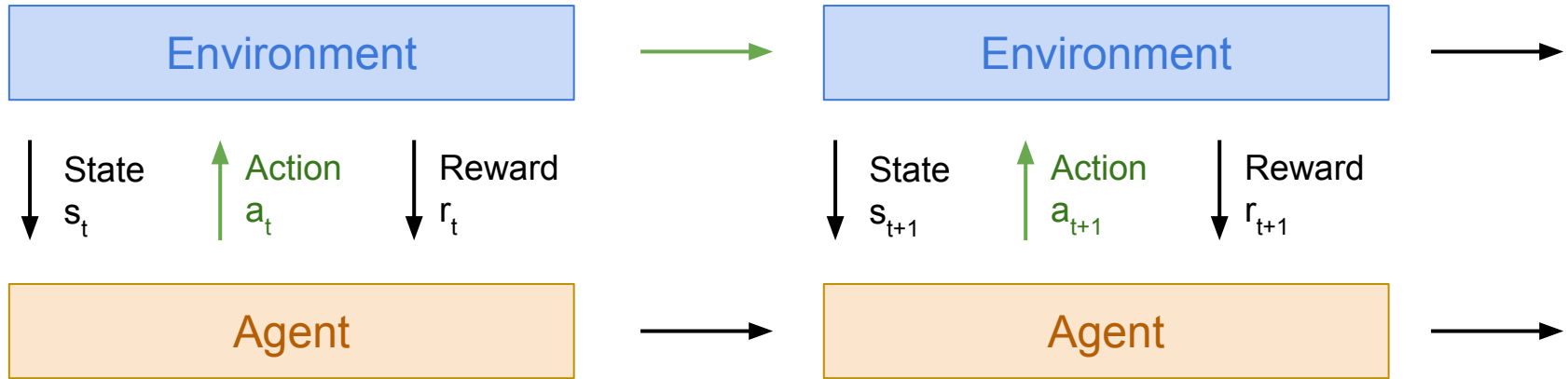

Nonstationary: What the agent experiences depends on how it acts

How can we mathematically formalize the RL problem?

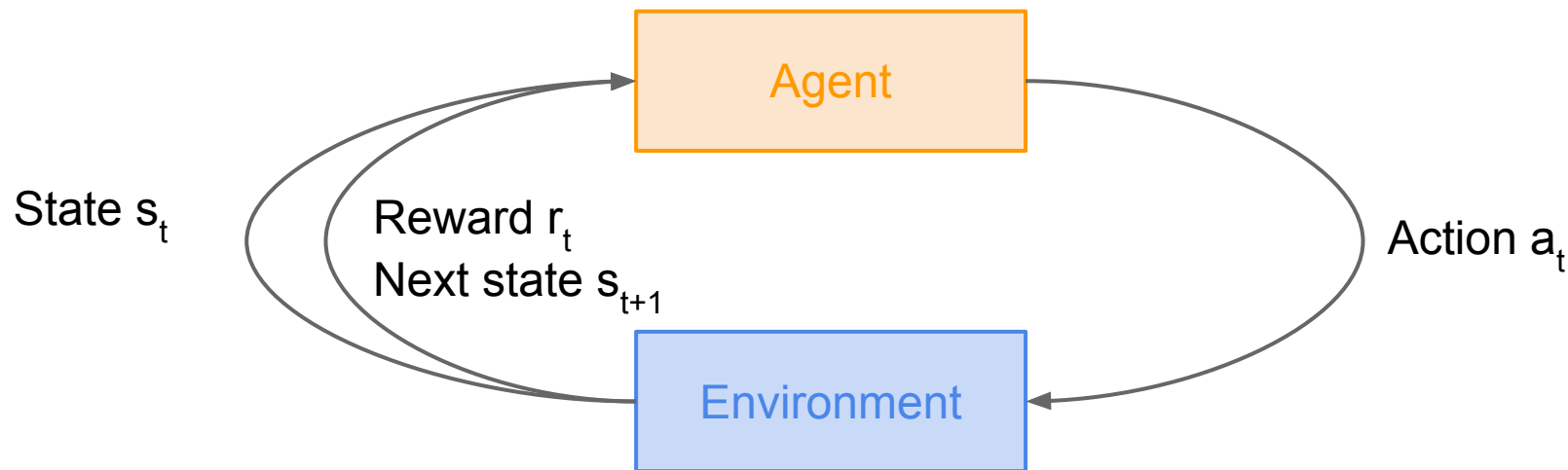

Markov Decision Process

- Mathematical formulation of the RL problem
- **Markov property**: Current state completely characterises the state of the world

Defined by: $(\mathcal{S}, \mathcal{A}, \mathcal{R}, \mathbb{P}, \gamma)$

\mathcal{S} : set of possible states

\mathcal{A} : set of possible actions

\mathcal{R} : distribution of reward given (state, action) pair

\mathbb{P} : transition probability i.e. distribution over next state given (state, action) pair

γ : discount factor

Markov Decision Process

- At time step $t=0$, environment samples initial state $s_0 \sim p(s_0)$
- Then, for $t=0$ until done:
 - Agent selects action a_t
 - Environment samples reward $r_t \sim R(\cdot | s_t, a_t)$
 - Environment samples next state $s_{t+1} \sim P(\cdot | s_t, a_t)$
 - Agent receives reward r_t and next state s_{t+1}
- A policy π is a function from S to A that specifies what action to take in each state
- **Objective:** find policy π^* that maximizes cumulative discounted reward: $\sum_{t \geq 0} \gamma^t r_t$

A simple MDP: Grid World

actions = {

1. right 

2. left 

3. up 

4. down 

}

states

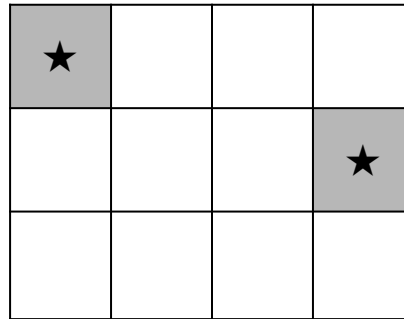

Set a negative “reward”
for each transition
(e.g. $r = -1$)

Objective: reach one of terminal states (greyed out) in
least number of actions

A simple MDP: Grid World

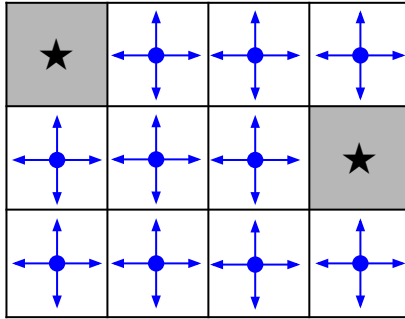

Random Policy

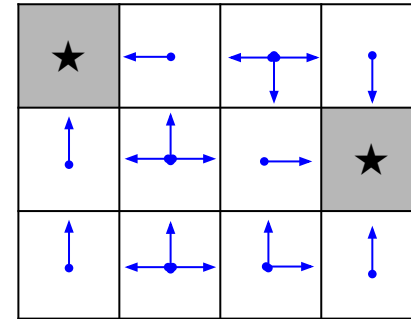

Optimal Policy

The optimal policy π^*

We want to find optimal policy π^* that maximizes the sum of rewards.

How do we handle the randomness (initial state, transition probability...)?

The optimal policy π^*

We want to find optimal policy π^* that maximizes the sum of rewards.

How do we handle the randomness (initial state, transition probability...)?

Maximize the **expected sum of rewards!**

$$\text{Formally: } \pi^* = \arg \max_{\pi} \mathbb{E} \left[\sum_{t \geq 0} \gamma^t r_t | \pi \right] \quad \text{with } s_0 \sim p(s_0), a_t \sim \pi(\cdot | s_t), s_{t+1} \sim p(\cdot | s_t, a_t)$$

Definitions: Value function and Q-value function

Following a policy produces sample trajectories (or paths) $s_0, a_0, r_0, s_1, a_1, r_1, \dots$

Definitions: Value function and Q-value function

Following a policy produces sample trajectories (or paths) $s_0, a_0, r_0, s_1, a_1, r_1, \dots$

How good is a state?

The **value function** at state s , is the expected cumulative reward from following the policy from state s :

$$V^\pi(s) = \mathbb{E} \left[\sum_{t \geq 0} \gamma^t r_t \mid s_0 = s, \pi \right]$$

Definitions: Value function and Q-value function

Following a policy produces sample trajectories (or paths) $s_0, a_0, r_0, s_1, a_1, r_1, \dots$

How good is a state?

The **value function** at state s , is the expected cumulative reward from following the policy from state s :

$$V^\pi(s) = \mathbb{E} \left[\sum_{t \geq 0} \gamma^t r_t \mid s_0 = s, \pi \right]$$

How good is a state-action pair?

The **Q-value function** at state s and action a , is the expected cumulative reward from taking action a in state s and then following the policy:

$$Q^\pi(s, a) = \mathbb{E} \left[\sum_{t \geq 0} \gamma^t r_t \mid s_0 = s, a_0 = a, \pi \right]$$

Bellman equation

The optimal Q-value function Q^* is the maximum expected cumulative reward achievable from a given (state, action) pair:

$$Q^*(s, a) = \max_{\pi} \mathbb{E} \left[\sum_{t \geq 0} \gamma^t r_t \mid s_0 = s, a_0 = a, \pi \right]$$

Bellman equation

The optimal Q-value function Q^* is the maximum expected cumulative reward achievable from a given (state, action) pair:

$$Q^*(s, a) = \max_{\pi} \mathbb{E} \left[\sum_{t \geq 0} \gamma^t r_t \mid s_0 = s, a_0 = a, \pi \right]$$

Q^* satisfies the following **Bellman equation**:

$$Q^*(s, a) = \mathbb{E}_{s' \sim \mathcal{E}} \left[r + \gamma \max_{a'} Q^*(s', a') \mid s, a \right]$$

Intuition: if the optimal state-action values for the next time-step $Q^*(s', a')$ are known, then the optimal strategy is to take the action that maximizes the expected value of $r + \gamma Q^*(s', a')$

Bellman equation

The optimal Q-value function Q^* is the maximum expected cumulative reward achievable from a given (state, action) pair:

$$Q^*(s, a) = \max_{\pi} \mathbb{E} \left[\sum_{t \geq 0} \gamma^t r_t \mid s_0 = s, a_0 = a, \pi \right]$$

Q^* satisfies the following **Bellman equation**:

$$Q^*(s, a) = \mathbb{E}_{s' \sim \mathcal{E}} \left[r + \gamma \max_{a'} Q^*(s', a') \mid s, a \right]$$

Intuition: if the optimal state-action values for the next time-step $Q^*(s', a')$ are known, then the optimal strategy is to take the action that maximizes the expected value of $r + \gamma Q^*(s', a')$

The optimal policy π^* corresponds to taking the best action in any state as specified by Q^*

Solving for the optimal policy

Value iteration algorithm: Use Bellman equation as an iterative update

$$Q_{i+1}(s, a) = \mathbb{E} \left[r + \gamma \max_{a'} Q_i(s', a') \mid s, a \right]$$

Q_i will converge to Q^* as $i \rightarrow \text{infinity}$

Solving for the optimal policy

Value iteration algorithm: Use Bellman equation as an iterative update

$$Q_{i+1}(s, a) = \mathbb{E} \left[r + \gamma \max_{a'} Q_i(s', a') \mid s, a \right]$$

Q_i will converge to Q^* as $i \rightarrow \text{infinity}$

What's the problem with this?

Solving for the optimal policy

Value iteration algorithm: Use Bellman equation as an iterative update

$$Q_{i+1}(s, a) = \mathbb{E} \left[r + \gamma \max_{a'} Q_i(s', a') | s, a \right]$$

Q_i will converge to Q^* as $i \rightarrow \text{infinity}$

What's the problem with this?

Not scalable. Must compute $Q(s, a)$ for every state-action pair. If state is e.g. current game state pixels, computationally infeasible to compute for entire state space!

Solving for the optimal policy

Value iteration algorithm: Use Bellman equation as an iterative update

$$Q_{i+1}(s, a) = \mathbb{E} \left[r + \gamma \max_{a'} Q_i(s', a') | s, a \right]$$

Q_i will converge to Q^* as $i \rightarrow \text{infinity}$

What's the problem with this?

Not scalable. Must compute $Q(s,a)$ for every state-action pair. If state is e.g. current game state pixels, computationally infeasible to compute for entire state space!

Solution: use a function approximator to estimate $Q(s,a)$. E.g. a neural network!

Solving for the optimal policy: Q-learning

Q-learning: Use a function approximator to estimate the action-value function

$$Q(s, a; \theta) \approx Q^*(s, a)$$

Solving for the optimal policy: Q-learning

Q-learning: Use a function approximator to estimate the action-value function

$$Q(s, a; \theta) \approx Q^*(s, a)$$

If the function approximator is a deep neural network => **deep q-learning!**

Solving for the optimal policy: Q-learning

Q-learning: Use a function approximator to estimate the action-value function

$$Q(s, a; \theta) \approx Q^*(s, a)$$

 function parameters (weights)

If the function approximator is a deep neural network => **deep q-learning!**

Solving for the optimal policy: Q-learning

Remember: want to find a Q-function that satisfies the Bellman Equation:

$$Q^*(s, a) = \mathbb{E}_{s' \sim \mathcal{E}} \left[r + \gamma \max_{a'} Q^*(s', a') | s, a \right]$$

Solving for the optimal policy: Q-learning

Remember: want to find a Q-function that satisfies the Bellman Equation:

$$Q^*(s, a) = \mathbb{E}_{s' \sim \mathcal{E}} \left[r + \gamma \max_{a'} Q^*(s', a') | s, a \right]$$

Forward Pass

Loss function: $L_i(\theta_i) = \mathbb{E}_{s, a \sim \rho(\cdot)} [(y_i - Q(s, a; \theta_i))^2]$

where $y_i = \mathbb{E}_{s' \sim \mathcal{E}} \left[r + \gamma \max_{a'} Q(s', a'; \theta_{i-1}) | s, a \right]$

Solving for the optimal policy: Q-learning

Remember: want to find a Q-function that satisfies the Bellman Equation:

$$Q^*(s, a) = \mathbb{E}_{s' \sim \mathcal{E}} \left[r + \gamma \max_{a'} Q^*(s', a') | s, a \right]$$

Forward Pass

Loss function: $L_i(\theta_i) = \mathbb{E}_{s, a \sim \rho(\cdot)} [(y_i - Q(s, a; \theta_i))^2]$

where $y_i = \mathbb{E}_{s' \sim \mathcal{E}} \left[r + \gamma \max_{a'} Q(s', a'; \theta_{i-1}) | s, a \right]$

Backward Pass

Gradient update (with respect to Q-function parameters θ):

$$\nabla_{\theta_i} L_i(\theta_i) = \mathbb{E}_{s, a \sim \rho(\cdot); s' \sim \mathcal{E}} \left[r + \gamma \max_{a'} Q(s', a'; \theta_{i-1}) - Q(s, a; \theta_i) \right] \nabla_{\theta_i} Q(s, a; \theta_i)$$

Solving for the optimal policy: Q-learning

Remember: want to find a Q-function that satisfies the Bellman Equation:

$$Q^*(s, a) = \mathbb{E}_{s' \sim \mathcal{E}} \left[r + \gamma \max_{a'} Q^*(s', a') | s, a \right]$$

Forward Pass

Loss function: $L_i(\theta_i) = \mathbb{E}_{s, a \sim \rho(\cdot)} \left[(y_i - Q(s, a; \theta_i))^2 \right]$

where $y_i = \mathbb{E}_{s' \sim \mathcal{E}} \left[r + \gamma \max_{a'} Q(s', a'; \theta_{i-1}) | s, a \right]$

Iteratively try to make the Q-value close to the target value (y_i) it should have, if Q-function corresponds to optimal Q^* (and optimal policy π^*)

Backward Pass

Gradient update (with respect to Q-function parameters θ):

$$\nabla_{\theta_i} L_i(\theta_i) = \mathbb{E}_{s, a \sim \rho(\cdot); s' \sim \mathcal{E}} \left[r + \gamma \max_{a'} Q(s', a'; \theta_{i-1}) - Q(s, a; \theta_i) \right] \nabla_{\theta_i} Q(s, a; \theta_i)$$

Case Study: Playing Atari Games



Objective: Complete the game with the highest score

State: Raw pixel inputs of the game state

Action: Game controls e.g. Left, Right, Up, Down

Reward: Score increase/decrease at each time step

Figures copyright Volodymyr Mnih et al., 2013. Reproduced with permission.

Q-network Architecture

$Q(s, a; \theta)$:
neural network
with weights θ

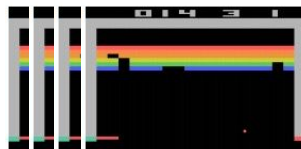
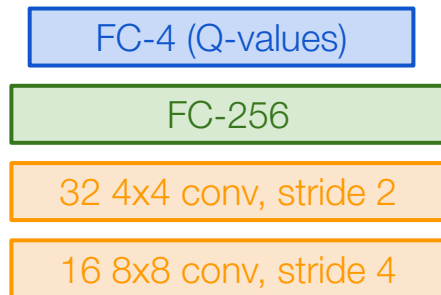

Current state s_t : 84x84x4 stack of last 4 frames
(after RGB->grayscale conversion, downsampling, and cropping)

Q-network Architecture

$Q(s, a; \theta)$:
neural network
with weights θ

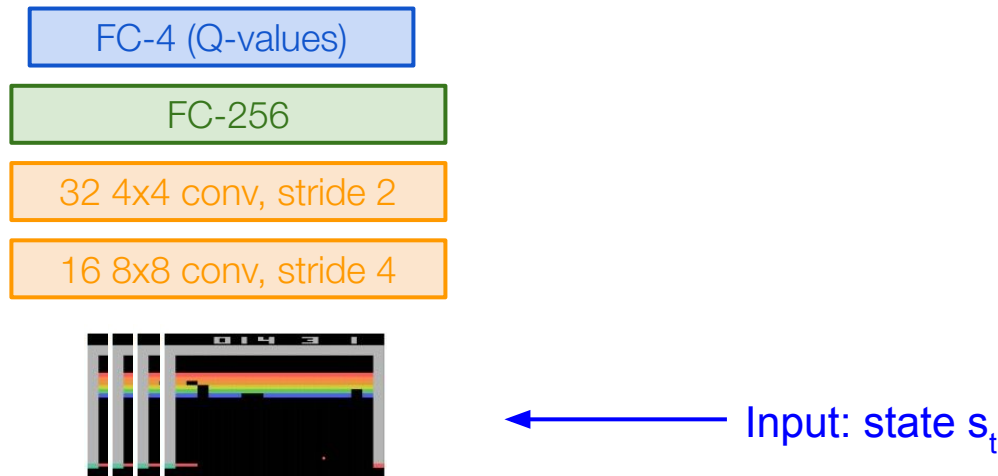

Current state s_t : 84x84x4 stack of last 4 frames
(after RGB->grayscale conversion, downsampling, and cropping)

Q-network Architecture

$Q(s, a; \theta)$:
neural network
with weights θ

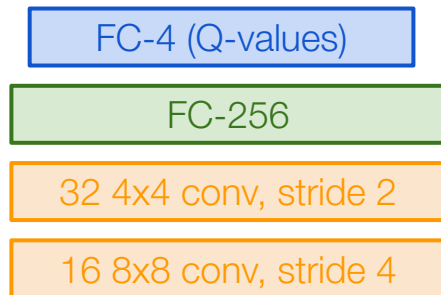

← Familiar conv layers,
FC layer

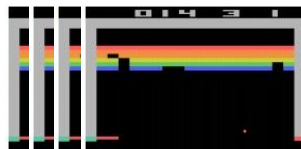

Current state s_t : 84x84x4 stack of last 4 frames
(after RGB->grayscale conversion, downsampling, and cropping)

Q-network Architecture

$Q(s, a; \theta)$:
neural network
with weights θ

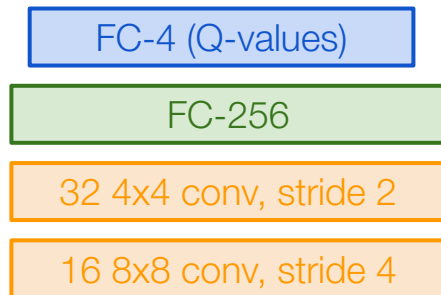

← Last FC layer has 4-d output (if 4 actions), corresponding to $Q(s_t, a_1)$, $Q(s_t, a_2)$, $Q(s_t, a_3)$, $Q(s_t, a_4)$

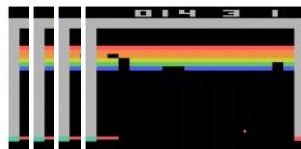

Current state s_t : 84x84x4 stack of last 4 frames
(after RGB->grayscale conversion, downsampling, and cropping)

Q-network Architecture

$Q(s, a; \theta)$:
neural network
with weights θ

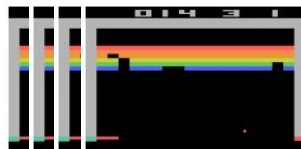
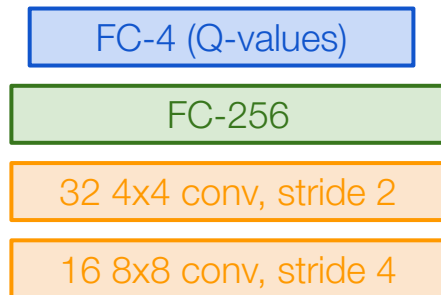

Current state s_t : 84x84x4 stack of last 4 frames
(after RGB->grayscale conversion, downsampling, and cropping)

← Last FC layer has 4-d output (if 4 actions), corresponding to $Q(s_t, a_1)$, $Q(s_t, a_2)$, $Q(s_t, a_3)$, $Q(s_t, a_4)$

Number of actions between 4-18 depending on Atari game

Q-network Architecture

$Q(s, a; \theta)$:
neural network
with weights θ

A single feedforward pass
to compute Q-values for all
actions from the current
state => efficient!

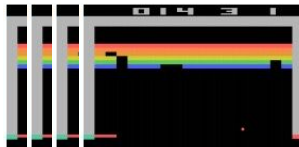
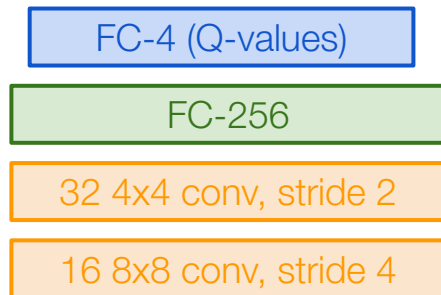

Current state s_t : 84x84x4 stack of last 4 frames
(after RGB->grayscale conversion, downsampling, and cropping)

← Last FC layer has 4-d
output (if 4 actions),
corresponding to $Q(s_t, a_1)$, $Q(s_t, a_2)$, $Q(s_t, a_3)$,
 $Q(s_t, a_4)$

Number of actions between 4-18
depending on Atari game

Training the Q-network: Loss function (from before)

Remember: want to find a Q-function that satisfies the Bellman Equation:

$$Q^*(s, a) = \mathbb{E}_{s' \sim \mathcal{E}} \left[r + \gamma \max_{a'} Q^*(s', a') | s, a \right]$$

Forward Pass

Loss function: $L_i(\theta_i) = \mathbb{E}_{s, a \sim \rho(\cdot)} \left[(y_i - Q(s, a; \theta_i))^2 \right]$

where $y_i = \mathbb{E}_{s' \sim \mathcal{E}} \left[r + \gamma \max_{a'} Q(s', a'; \theta_{i-1}) | s, a \right]$

Iteratively try to make the Q-value close to the target value (y_i) it should have, if Q-function corresponds to optimal Q^* (and optimal policy π^*)

Backward Pass

Gradient update (with respect to Q-function parameters θ):

$$\nabla_{\theta_i} L_i(\theta_i) = \mathbb{E}_{s, a \sim \rho(\cdot); s' \sim \mathcal{E}} \left[r + \gamma \max_{a'} Q(s', a'; \theta_{i-1}) - Q(s, a; \theta_i) \right] \nabla_{\theta_i} Q(s, a; \theta_i)$$

Training the Q-network: Experience Replay

Learning from batches of consecutive samples is problematic:

- Samples are correlated => inefficient learning
- Current Q-network parameters determines next training samples (e.g. if maximizing action is to move left, training samples will be dominated by samples from left-hand size) => can lead to bad feedback loops

Training the Q-network: Experience Replay

Learning from batches of consecutive samples is problematic:

- Samples are correlated => inefficient learning
- Current Q-network parameters determines next training samples (e.g. if maximizing action is to move left, training samples will be dominated by samples from left-hand size) => can lead to bad feedback loops

Address these problems using **experience replay**

- Continually update a **replay memory** table of transitions (s_t, a_t, r_t, s_{t+1}) as game (experience) episodes are played
- Train Q-network on random minibatches of transitions from the replay memory, instead of consecutive samples

Training the Q-network: Experience Replay

Learning from batches of consecutive samples is problematic:

- Samples are correlated => inefficient learning
- Current Q-network parameters determines next training samples (e.g. if maximizing action is to move left, training samples will be dominated by samples from left-hand size) => can lead to bad feedback loops

Address these problems using **experience replay**

- Continually update a **replay memory** table of transitions (s_t, a_t, r_t, s_{t+1}) as game (experience) episodes are played
- Train Q-network on random minibatches of transitions from the replay memory, instead of consecutive samples

Each transition can also contribute to multiple weight updates
=> greater data efficiency

Putting it together: Deep Q-Learning with Experience Replay

Algorithm 1 Deep Q-learning with Experience Replay

Initialize replay memory \mathcal{D} to capacity N

Initialize action-value function Q with random weights

for episode = 1, M **do**

 Initialize sequence $s_1 = \{x_1\}$ and preprocessed sequenced $\phi_1 = \phi(s_1)$

for $t = 1, T$ **do**

 With probability ϵ select a random action a_t

 otherwise select $a_t = \max_a Q^*(\phi(s_t), a; \theta)$

 Execute action a_t in emulator and observe reward r_t and image x_{t+1}

 Set $s_{t+1} = s_t, a_t, x_{t+1}$ and preprocess $\phi_{t+1} = \phi(s_{t+1})$

 Store transition $(\phi_t, a_t, r_t, \phi_{t+1})$ in \mathcal{D}

 Sample random minibatch of transitions $(\phi_j, a_j, r_j, \phi_{j+1})$ from \mathcal{D}

 Set $y_j = \begin{cases} r_j & \text{for terminal } \phi_{j+1} \\ r_j + \gamma \max_{a'} Q(\phi_{j+1}, a'; \theta) & \text{for non-terminal } \phi_{j+1} \end{cases}$

 Perform a gradient descent step on $(y_j - Q(\phi_j, a_j; \theta))^2$ according to equation 3

end for

end for

Putting it together: Deep Q-Learning with Experience Replay

Algorithm 1 Deep Q-learning with Experience Replay

Initialize replay memory \mathcal{D} to capacity N

Initialize action-value function Q with random weights

← Initialize replay memory, Q-network

for episode = 1, M **do**

 Initialize sequence $s_1 = \{x_1\}$ and preprocessed sequenced $\phi_1 = \phi(s_1)$

for $t = 1, T$ **do**

 With probability ϵ select a random action a_t

 otherwise select $a_t = \max_a Q^*(\phi(s_t), a; \theta)$

 Execute action a_t in emulator and observe reward r_t and image x_{t+1}

 Set $s_{t+1} = s_t, a_t, x_{t+1}$ and preprocess $\phi_{t+1} = \phi(s_{t+1})$

 Store transition $(\phi_t, a_t, r_t, \phi_{t+1})$ in \mathcal{D}

 Sample random minibatch of transitions $(\phi_j, a_j, r_j, \phi_{j+1})$ from \mathcal{D}

 Set $y_j = \begin{cases} r_j & \text{for terminal } \phi_{j+1} \\ r_j + \gamma \max_{a'} Q(\phi_{j+1}, a'; \theta) & \text{for non-terminal } \phi_{j+1} \end{cases}$

 Perform a gradient descent step on $(y_j - Q(\phi_j, a_j; \theta))^2$ according to equation 3

end for

end for

Putting it together: Deep Q-Learning with Experience Replay

Algorithm 1 Deep Q-learning with Experience Replay

Initialize replay memory \mathcal{D} to capacity N

Initialize action-value function Q with random weights

for episode = 1, M **do**

← Play M episodes (full games)

 Initialize sequence $s_1 = \{x_1\}$ and preprocessed sequenced $\phi_1 = \phi(s_1)$

for $t = 1, T$ **do**

 With probability ϵ select a random action a_t

 otherwise select $a_t = \max_a Q^*(\phi(s_t), a; \theta)$

 Execute action a_t in emulator and observe reward r_t and image x_{t+1}

 Set $s_{t+1} = s_t, a_t, x_{t+1}$ and preprocess $\phi_{t+1} = \phi(s_{t+1})$

 Store transition $(\phi_t, a_t, r_t, \phi_{t+1})$ in \mathcal{D}

 Sample random minibatch of transitions $(\phi_j, a_j, r_j, \phi_{j+1})$ from \mathcal{D}

 Set $y_j = \begin{cases} r_j & \text{for terminal } \phi_{j+1} \\ r_j + \gamma \max_{a'} Q(\phi_{j+1}, a'; \theta) & \text{for non-terminal } \phi_{j+1} \end{cases}$

 Perform a gradient descent step on $(y_j - Q(\phi_j, a_j; \theta))^2$ according to equation 3

end for

end for

Putting it together: Deep Q-Learning with Experience Replay

Algorithm 1 Deep Q-learning with Experience Replay

Initialize replay memory \mathcal{D} to capacity N

Initialize action-value function Q with random weights

for episode = 1, M **do**

 Initialize sequence $s_1 = \{x_1\}$ and preprocessed sequenced $\phi_1 = \phi(s_1)$ ←

for $t = 1, T$ **do**

 With probability ϵ select a random action a_t

 otherwise select $a_t = \max_a Q^*(\phi(s_t), a; \theta)$

 Execute action a_t in emulator and observe reward r_t and image x_{t+1}

 Set $s_{t+1} = s_t, a_t, x_{t+1}$ and preprocess $\phi_{t+1} = \phi(s_{t+1})$

 Store transition $(\phi_t, a_t, r_t, \phi_{t+1})$ in \mathcal{D}

 Sample random minibatch of transitions $(\phi_j, a_j, r_j, \phi_{j+1})$ from \mathcal{D}

 Set $y_j = \begin{cases} r_j & \text{for terminal } \phi_{j+1} \\ r_j + \gamma \max_{a'} Q(\phi_{j+1}, a'; \theta) & \text{for non-terminal } \phi_{j+1} \end{cases}$

 Perform a gradient descent step on $(y_j - Q(\phi_j, a_j; \theta))^2$ according to equation 3

end for

end for

Initialize state
(starting game
screen pixels) at the
beginning of each
episode

Putting it together: Deep Q-Learning with Experience Replay

Algorithm 1 Deep Q-learning with Experience Replay

Initialize replay memory \mathcal{D} to capacity N

Initialize action-value function Q with random weights

for episode = 1, M **do**

 Initialize sequence $s_1 = \{x_1\}$ and preprocessed sequenced $\phi_1 = \phi(s_1)$

for $t = 1, T$ **do**

 With probability ϵ select a random action a_t

 otherwise select $a_t = \max_a Q^*(\phi(s_t), a; \theta)$

 Execute action a_t in emulator and observe reward r_t and image x_{t+1}

 Set $s_{t+1} = s_t, a_t, x_{t+1}$ and preprocess $\phi_{t+1} = \phi(s_{t+1})$

 Store transition $(\phi_t, a_t, r_t, \phi_{t+1})$ in \mathcal{D}

 Sample random minibatch of transitions $(\phi_j, a_j, r_j, \phi_{j+1})$ from \mathcal{D}

 Set $y_j = \begin{cases} r_j & \text{for terminal } \phi_{j+1} \\ r_j + \gamma \max_{a'} Q(\phi_{j+1}, a'; \theta) & \text{for non-terminal } \phi_{j+1} \end{cases}$

 Perform a gradient descent step on $(y_j - Q(\phi_j, a_j; \theta))^2$ according to equation 3

end for

end for



For each timestep t
of the game

Putting it together: Deep Q-Learning with Experience Replay

Algorithm 1 Deep Q-learning with Experience Replay

Initialize replay memory \mathcal{D} to capacity N

Initialize action-value function Q with random weights

for episode = 1, M **do**

 Initialize sequence $s_1 = \{x_1\}$ and preprocessed sequenced $\phi_1 = \phi(s_1)$

for $t = 1, T$ **do**

 With probability ϵ select a random action a_t

 otherwise select $a_t = \max_a Q^*(\phi(s_t), a; \theta)$

 Execute action a_t in emulator and observe reward r_t and image x_{t+1}

 Set $s_{t+1} = s_t, a_t, x_{t+1}$ and preprocess $\phi_{t+1} = \phi(s_{t+1})$

 Store transition $(\phi_t, a_t, r_t, \phi_{t+1})$ in \mathcal{D}

 Sample random minibatch of transitions $(\phi_j, a_j, r_j, \phi_{j+1})$ from \mathcal{D}

 Set $y_j = \begin{cases} r_j & \text{for terminal } \phi_{j+1} \\ r_j + \gamma \max_{a'} Q(\phi_{j+1}, a'; \theta) & \text{for non-terminal } \phi_{j+1} \end{cases}$

 Perform a gradient descent step on $(y_j - Q(\phi_j, a_j; \theta))^2$ according to equation 3

end for

end for

← With small probability, select a random action (explore), otherwise select greedy action from current policy

Putting it together: Deep Q-Learning with Experience Replay

Algorithm 1 Deep Q-learning with Experience Replay

Initialize replay memory \mathcal{D} to capacity N

Initialize action-value function Q with random weights

for episode = 1, M **do**

 Initialize sequence $s_1 = \{x_1\}$ and preprocessed sequenced $\phi_1 = \phi(s_1)$

for $t = 1, T$ **do**

 With probability ϵ select a random action a_t

 otherwise select $a_t = \max_a Q^*(\phi(s_t), a; \theta)$

 Execute action a_t in emulator and observe reward r_t and image x_{t+1}

 Set $s_{t+1} = s_t, a_t, x_{t+1}$ and preprocess $\phi_{t+1} = \phi(s_{t+1})$

 Store transition $(\phi_t, a_t, r_t, \phi_{t+1})$ in \mathcal{D}

 Sample random minibatch of transitions $(\phi_j, a_j, r_j, \phi_{j+1})$ from \mathcal{D}

 Set $y_j = \begin{cases} r_j & \text{for terminal } \phi_{j+1} \\ r_j + \gamma \max_{a'} Q(\phi_{j+1}, a'; \theta) & \text{for non-terminal } \phi_{j+1} \end{cases}$

 Perform a gradient descent step on $(y_j - Q(\phi_j, a_j; \theta))^2$ according to equation 3

end for

end for

← Take the action (a_t), and observe the reward r_t and next state s_{t+1}

Putting it together: Deep Q-Learning with Experience Replay

Algorithm 1 Deep Q-learning with Experience Replay

Initialize replay memory \mathcal{D} to capacity N

Initialize action-value function Q with random weights

for episode = 1, M **do**

 Initialize sequence $s_1 = \{x_1\}$ and preprocessed sequenced $\phi_1 = \phi(s_1)$

for $t = 1, T$ **do**

 With probability ϵ select a random action a_t

 otherwise select $a_t = \max_a Q^*(\phi(s_t), a; \theta)$

 Execute action a_t in emulator and observe reward r_t and image x_{t+1}

 Set $s_{t+1} = s_t, a_t, x_{t+1}$ and preprocess $\phi_{t+1} = \phi(s_{t+1})$

 Store transition $(\phi_t, a_t, r_t, \phi_{t+1})$ in \mathcal{D}

 Sample random minibatch of transitions $(\phi_j, a_j, r_j, \phi_{j+1})$ from \mathcal{D}

 Set $y_j = \begin{cases} r_j & \text{for terminal } \phi_{j+1} \\ r_j + \gamma \max_{a'} Q(\phi_{j+1}, a'; \theta) & \text{for non-terminal } \phi_{j+1} \end{cases}$

 Perform a gradient descent step on $(y_j - Q(\phi_j, a_j; \theta))^2$ according to equation 3

end for

end for

← Store transition in
replay memory

Putting it together: Deep Q-Learning with Experience Replay

Algorithm 1 Deep Q-learning with Experience Replay

Initialize replay memory \mathcal{D} to capacity N

Initialize action-value function Q with random weights

for episode = 1, M **do**

 Initialize sequence $s_1 = \{x_1\}$ and preprocessed sequenced $\phi_1 = \phi(s_1)$

for $t = 1, T$ **do**

 With probability ϵ select a random action a_t

 otherwise select $a_t = \max_a Q^*(\phi(s_t), a; \theta)$

 Execute action a_t in emulator and observe reward r_t and image x_{t+1}

 Set $s_{t+1} = s_t, a_t, x_{t+1}$ and preprocess $\phi_{t+1} = \phi(s_{t+1})$

 Store transition $(\phi_t, a_t, r_t, \phi_{t+1})$ in \mathcal{D}

 Sample random minibatch of transitions $(\phi_j, a_j, r_j, \phi_{j+1})$ from \mathcal{D}

 Set $y_j = \begin{cases} r_j & \text{for terminal } \phi_{j+1} \\ r_j + \gamma \max_{a'} Q(\phi_{j+1}, a'; \theta) & \text{for non-terminal } \phi_{j+1} \end{cases}$

 Perform a gradient descent step on $(y_j - Q(\phi_j, a_j; \theta))^2$ according to equation 3

end for

end for

← Experience Replay:
Sample a random minibatch of transitions from replay memory and perform a gradient descent step



<https://www.youtube.com/watch?v=V1eYniJ0Rnk>

Video by Károly Zsolnai-Fehér. Reproduced with permission.

Policy Gradients

What is a problem with Q-learning?

The Q-function can be very complicated!

Example: a robot grasping an object has a very high-dimensional state => hard to learn exact value of every (state, action) pair

Policy Gradients

What is a problem with Q-learning?

The Q-function can be very complicated!

Example: a robot grasping an object has a very high-dimensional state => hard to learn exact value of every (state, action) pair

But the policy can be much simpler: just close your hand

Can we learn a policy directly, e.g. finding the best policy from a collection of policies?

Policy Gradients

Formally, let's define a class of parameterized policies: $\Pi = \{\pi_\theta, \theta \in \mathbb{R}^m\}$

For each policy, define its value:

$$J(\theta) = \mathbb{E} \left[\sum_{t \geq 0} \gamma^t r_t | \pi_\theta \right]$$

Policy Gradients

Formally, let's define a class of parameterized policies: $\Pi = \{\pi_\theta, \theta \in \mathbb{R}^m\}$

For each policy, define its value:

$$J(\theta) = \mathbb{E} \left[\sum_{t \geq 0} \gamma^t r_t | \pi_\theta \right]$$

We want to find the optimal policy $\theta^* = \arg \max_{\theta} J(\theta)$

How can we do this?

Policy Gradients

Formally, let's define a class of parameterized policies: $\Pi = \{\pi_\theta, \theta \in \mathbb{R}^m\}$

For each policy, define its value:

$$J(\theta) = \mathbb{E} \left[\sum_{t \geq 0} \gamma^t r_t | \pi_\theta \right]$$

We want to find the optimal policy $\theta^* = \arg \max_{\theta} J(\theta)$

How can we do this?

Gradient ascent on policy parameters!

REINFORCE algorithm

Mathematically, we can write:

$$\begin{aligned} J(\theta) &= \mathbb{E}_{\tau \sim p(\tau; \theta)} [r(\tau)] \\ &= \int_{\tau} r(\tau) p(\tau; \theta) d\tau \end{aligned}$$

Where $r(\tau)$ is the reward of a trajectory $\tau = (s_0, a_0, r_0, s_1, \dots)$

REINFORCE algorithm

Expected reward:

$$J(\theta) = \mathbb{E}_{\tau \sim p(\tau; \theta)} [r(\tau)]$$
$$= \int_{\tau} r(\tau) p(\tau; \theta) d\tau$$

REINFORCE algorithm

Expected reward: $J(\theta) = \mathbb{E}_{\tau \sim p(\tau; \theta)} [r(\tau)]$

$$= \int_{\tau} r(\tau) p(\tau; \theta) d\tau$$

Now let's differentiate this: $\nabla_{\theta} J(\theta) = \int_{\tau} r(\tau) \nabla_{\theta} p(\tau; \theta) d\tau$

REINFORCE algorithm

Expected reward: $J(\theta) = \mathbb{E}_{\tau \sim p(\tau; \theta)} [r(\tau)]$

$$= \int_{\tau} r(\tau) p(\tau; \theta) d\tau$$

Now let's differentiate this: $\nabla_{\theta} J(\theta) = \int_{\tau} r(\tau) \nabla_{\theta} p(\tau; \theta) d\tau$

Intractable! Gradient of an expectation is problematic when p depends on θ

REINFORCE algorithm

Expected reward: $J(\theta) = \mathbb{E}_{\tau \sim p(\tau; \theta)} [r(\tau)]$

$$= \int_{\tau} r(\tau) p(\tau; \theta) d\tau$$

Now let's differentiate this: $\nabla_{\theta} J(\theta) = \int_{\tau} r(\tau) \nabla_{\theta} p(\tau; \theta) d\tau$

Intractable! Gradient of an expectation is problematic when p depends on θ

However, we can use a nice trick: $\nabla_{\theta} p(\tau; \theta) = p(\tau; \theta) \frac{\nabla_{\theta} p(\tau; \theta)}{p(\tau; \theta)} = p(\tau; \theta) \nabla_{\theta} \log p(\tau; \theta)$

REINFORCE algorithm

Expected reward: $J(\theta) = \mathbb{E}_{\tau \sim p(\tau; \theta)} [r(\tau)]$

$$= \int_{\tau} r(\tau) p(\tau; \theta) d\tau$$

Now let's differentiate this: $\nabla_{\theta} J(\theta) = \int_{\tau} r(\tau) \nabla_{\theta} p(\tau; \theta) d\tau$

Intractable! Gradient of an expectation is problematic when p depends on θ

However, we can use a nice trick: $\nabla_{\theta} p(\tau; \theta) = p(\tau; \theta) \frac{\nabla_{\theta} p(\tau; \theta)}{p(\tau; \theta)} = p(\tau; \theta) \nabla_{\theta} \log p(\tau; \theta)$

If we inject this back:

$$\begin{aligned} \nabla_{\theta} J(\theta) &= \int_{\tau} (r(\tau) \nabla_{\theta} \log p(\tau; \theta)) p(\tau; \theta) d\tau \\ &= \mathbb{E}_{\tau \sim p(\tau; \theta)} [r(\tau) \nabla_{\theta} \log p(\tau; \theta)] \end{aligned}$$

Can estimate with
Monte Carlo sampling

REINFORCE algorithm

Can we compute those quantities without knowing the transition probabilities?

We have: $p(\tau; \theta) = \prod_{t \geq 0} p(s_{t+1} | s_t, a_t) \pi_{\theta}(a_t | s_t)$

REINFORCE algorithm

Can we compute those quantities without knowing the transition probabilities?

We have: $p(\tau; \theta) = \prod_{t \geq 0} p(s_{t+1} | s_t, a_t) \pi_{\theta}(a_t | s_t)$

Thus: $\log p(\tau; \theta) = \sum_{t \geq 0} \log p(s_{t+1} | s_t, a_t) + \log \pi_{\theta}(a_t | s_t)$

REINFORCE algorithm

Can we compute those quantities without knowing the transition probabilities?

We have: $p(\tau; \theta) = \prod_{t \geq 0} p(s_{t+1} | s_t, a_t) \pi_{\theta}(a_t | s_t)$

Thus: $\log p(\tau; \theta) = \sum_{t \geq 0} \log p(s_{t+1} | s_t, a_t) + \log \pi_{\theta}(a_t | s_t)$

And when differentiating: $\nabla_{\theta} \log p(\tau; \theta) = \sum_{t \geq 0} \nabla_{\theta} \log \pi_{\theta}(a_t | s_t)$

Doesn't depend on
transition probabilities!

REINFORCE algorithm

$$\begin{aligned}\nabla_{\theta} J(\theta) &= \int_{\tau} (r(\tau) \nabla_{\theta} \log p(\tau; \theta)) p(\tau; \theta) d\tau \\ &= \mathbb{E}_{\tau \sim p(\tau; \theta)} [r(\tau) \nabla_{\theta} \log p(\tau; \theta)]\end{aligned}$$

Can we compute those quantities without knowing the transition probabilities?

We have: $p(\tau; \theta) = \prod_{t \geq 0} p(s_{t+1} | s_t, a_t) \pi_{\theta}(a_t | s_t)$

Thus: $\log p(\tau; \theta) = \sum_{t \geq 0} \log p(s_{t+1} | s_t, a_t) + \log \pi_{\theta}(a_t | s_t)$

And when differentiating: $\nabla_{\theta} \log p(\tau; \theta) = \sum_{t \geq 0} \nabla_{\theta} \log \pi_{\theta}(a_t | s_t)$

Doesn't depend on
transition probabilities!

Therefore when sampling a trajectory τ , we can estimate $J(\theta)$ with

$$\nabla_{\theta} J(\theta) \approx \sum_{t \geq 0} r(\tau) \nabla_{\theta} \log \pi_{\theta}(a_t | s_t)$$

Intuition

Gradient estimator:
$$\nabla_{\theta} J(\theta) \approx \sum_{t \geq 0} r(\tau) \nabla_{\theta} \log \pi_{\theta}(a_t | s_t)$$

Interpretation:

- If $r(\tau)$ is high, push up the probabilities of the actions seen
- If $r(\tau)$ is low, push down the probabilities of the actions seen

Intuition

Gradient estimator:
$$\nabla_{\theta} J(\theta) \approx \sum_{t \geq 0} r(\tau) \nabla_{\theta} \log \pi_{\theta}(a_t | s_t)$$

Interpretation:

- If $r(\tau)$ is high, push up the probabilities of the actions seen
- If $r(\tau)$ is low, push down the probabilities of the actions seen

Might seem simplistic to say that if a trajectory is good then all its actions were good. **But in expectation, it averages out!**

Intuition

Gradient estimator:
$$\nabla_{\theta} J(\theta) \approx \sum_{t \geq 0} r(\tau) \nabla_{\theta} \log \pi_{\theta}(a_t | s_t)$$

Interpretation:

- If $r(\tau)$ is high, push up the probabilities of the actions seen
- If $r(\tau)$ is low, push down the probabilities of the actions seen

Might seem simplistic to say that if a trajectory is good then all its actions were good. **But in expectation, it averages out!**

However, this also suffers from high variance because credit assignment is really hard. Can we help the estimator?

Variance reduction

Gradient estimator: $\nabla_{\theta} J(\theta) \approx \sum_{t \geq 0} r(\tau) \nabla_{\theta} \log \pi_{\theta}(a_t | s_t)$

Variance reduction

Gradient estimator: $\nabla_{\theta} J(\theta) \approx \sum_{t \geq 0} r(\tau) \nabla_{\theta} \log \pi_{\theta}(a_t | s_t)$

First idea: Push up probabilities of an action seen, only by the cumulative future reward from that state

$$\nabla_{\theta} J(\theta) \approx \sum_{t \geq 0} \left(\sum_{t' \geq t} r_{t'} \right) \nabla_{\theta} \log \pi_{\theta}(a_t | s_t)$$

Variance reduction

Gradient estimator:
$$\nabla_{\theta} J(\theta) \approx \sum_{t \geq 0} r(\tau) \nabla_{\theta} \log \pi_{\theta}(a_t | s_t)$$

First idea: Push up probabilities of an action seen, only by the cumulative future reward from that state

$$\nabla_{\theta} J(\theta) \approx \sum_{t \geq 0} \left(\sum_{t' \geq t} r_{t'} \right) \nabla_{\theta} \log \pi_{\theta}(a_t | s_t)$$

Second idea: Use discount factor γ to ignore delayed effects

$$\nabla_{\theta} J(\theta) \approx \sum_{t \geq 0} \left(\sum_{t' \geq t} \gamma^{t'-t} r_{t'} \right) \nabla_{\theta} \log \pi_{\theta}(a_t | s_t)$$

Variance reduction: Baseline

Problem: The raw value of a trajectory isn't necessarily meaningful. For example, if rewards are all positive, you keep pushing up probabilities of actions.

What is important then? Whether a reward is better or worse than what you expect to get

Idea: Introduce a baseline function dependent on the state.
Concretely, estimator is now:

$$\nabla_{\theta} J(\theta) \approx \sum_{t \geq 0} \left(\sum_{t' \geq t} \gamma^{t'-t} r_{t'} - b(s_t) \right) \nabla_{\theta} \log \pi_{\theta}(a_t | s_t)$$

How to choose the baseline?

$$\nabla_{\theta} J(\theta) \approx \sum_{t \geq 0} \left(\sum_{t' \geq t} \gamma^{t'-t} r_{t'} - b(s_t) \right) \nabla_{\theta} \log \pi_{\theta}(a_t | s_t)$$

A simple baseline: constant moving average of rewards experienced so far from all trajectories

How to choose the baseline?

$$\nabla_{\theta} J(\theta) \approx \sum_{t \geq 0} \left(\sum_{t' \geq t} \gamma^{t'-t} r_{t'} - b(s_t) \right) \nabla_{\theta} \log \pi_{\theta}(a_t | s_t)$$

A simple baseline: constant moving average of rewards experienced so far from all trajectories

Variance reduction techniques seen so far are typically used in “Vanilla REINFORCE”

How to choose the baseline?

A better baseline: Want to push up the probability of an action from a state, if this action was better than the **expected value of what we should get from that state**.

Q: What does this remind you of?

How to choose the baseline?

A better baseline: Want to push up the probability of an action from a state, if this action was better than the **expected value of what we should get from that state**.

Q: What does this remind you of?

A: Q-function and value function!

How to choose the baseline?

A better baseline: Want to push up the probability of an action from a state, if this action was better than the **expected value of what we should get from that state**.

Q: What does this remind you of?

A: Q-function and value function!

Intuitively, we are happy with an action a_t in a state s_t if $Q^\pi(s_t, a_t) - V^\pi(s_t)$ is large. On the contrary, we are unhappy with an action if it's small.

How to choose the baseline?

A better baseline: Want to push up the probability of an action from a state, if this action was better than the **expected value of what we should get from that state**.

Q: What does this remind you of?

A: Q-function and value function!

Intuitively, we are happy with an action a_t in a state s_t if $Q^\pi(s_t, a_t) - V^\pi(s_t)$ is large. On the contrary, we are unhappy with an action if it's small.

Using this, we get the estimator:
$$\nabla_\theta J(\theta) \approx \sum_{t \geq 0} (Q^{\pi_\theta}(s_t, a_t) - V^{\pi_\theta}(s_t)) \nabla_\theta \log \pi_\theta(a_t | s_t)$$

Actor-Critic Algorithm

Problem: we don't know Q and V. Can we learn them?

Yes, using Q-learning! We can combine Policy Gradients and Q-learning by training both an **actor** (the policy) and a **critic** (the Q-function).

- The actor decides which action to take, and the critic tells the actor how good its action was and how it should adjust
- Also alleviates the task of the critic as it only has to learn the values of (state, action) pairs generated by the policy
- Can also incorporate Q-learning tricks e.g. experience replay
- **Remark:** we can define by the **advantage function** how much an action was better than expected

$$A^\pi(s, a) = Q^\pi(s, a) - V^\pi(s)$$

Actor-Critic Algorithm

Initialize policy parameters θ , critic parameters ϕ

For iteration=1, 2 ... **do**

 Sample m trajectories under the current policy

$\Delta\theta \leftarrow 0$

For $i=1, \dots, m$ **do**

For $t=1, \dots, T$ **do**

$$A_t = \sum_{t' \geq t} \gamma^{t'-t} r_{t'}^i - V_\phi(s_t^i)$$

$$\Delta\theta \leftarrow \Delta\theta + A_t \nabla_\theta \log(a_t^i | s_t^i)$$

$$\Delta\phi \leftarrow \sum_i \sum_t \nabla_\phi \|A_t^i\|^2$$

$$\theta \leftarrow \alpha \Delta\theta$$

$$\phi \leftarrow \beta \Delta\phi$$

End for

REINFORCE in action: Recurrent Attention Model (RAM)

Objective: Image Classification

Take a sequence of “glimpses” selectively focusing on regions of the image, to predict class

- Inspiration from human perception and eye movements
- Saves computational resources => scalability
- Able to ignore clutter / irrelevant parts of image

State: Glimpses seen so far

Action: (x,y) coordinates (center of glimpse) of where to look next in image

Reward: 1 at the final timestep if image correctly classified, 0 otherwise

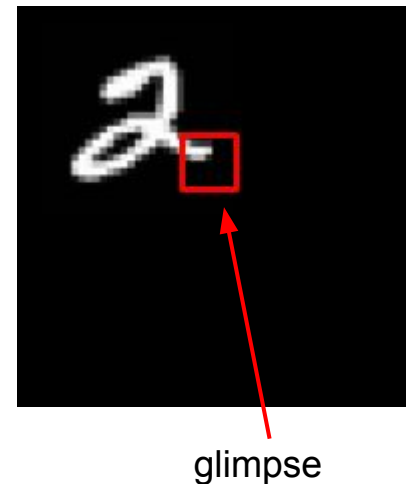

[Mnih et al. 2014]

REINFORCE in action: Recurrent Attention Model (RAM)

Objective: Image Classification

Take a sequence of “glimpses” selectively focusing on regions of the image, to predict class

- Inspiration from human perception and eye movements
- Saves computational resources => scalability
- Able to ignore clutter / irrelevant parts of image

State: Glimpses seen so far

Action: (x,y) coordinates (center of glimpse) of where to look next in image

Reward: 1 at the final timestep if image correctly classified, 0 otherwise

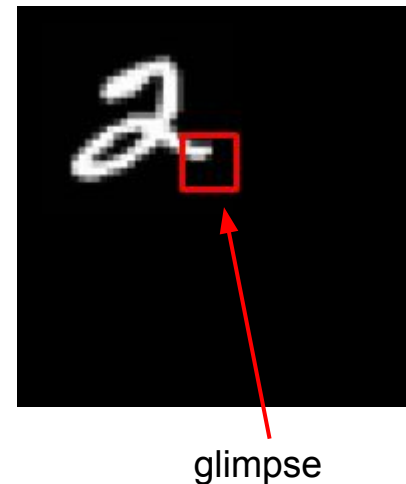

Glimpsing is a non-differentiable operation => learn policy for how to take glimpse actions using REINFORCE
Given state of glimpses seen so far, use RNN to model the state and output next action

[Mnih et al. 2014]

REINFORCE in action: Recurrent Attention Model (RAM)

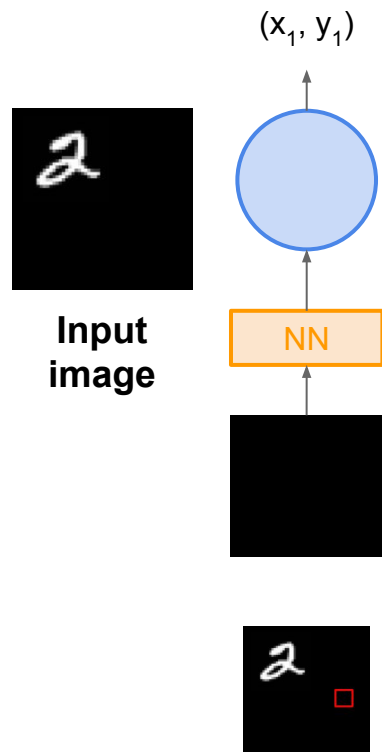

[Mnih et al. 2014]

REINFORCE in action: Recurrent Attention Model (RAM)

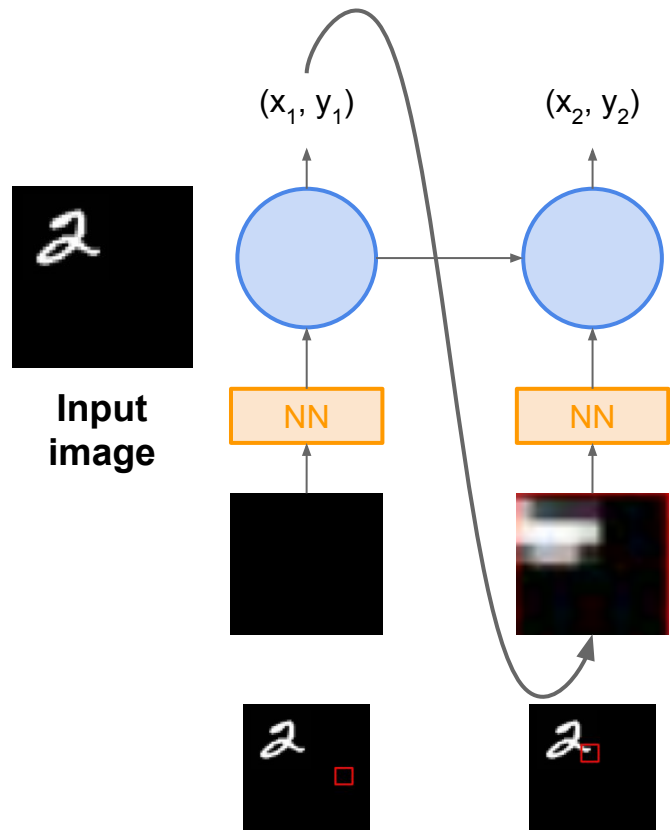

[Mnih et al. 2014]

REINFORCE in action: Recurrent Attention Model (RAM)

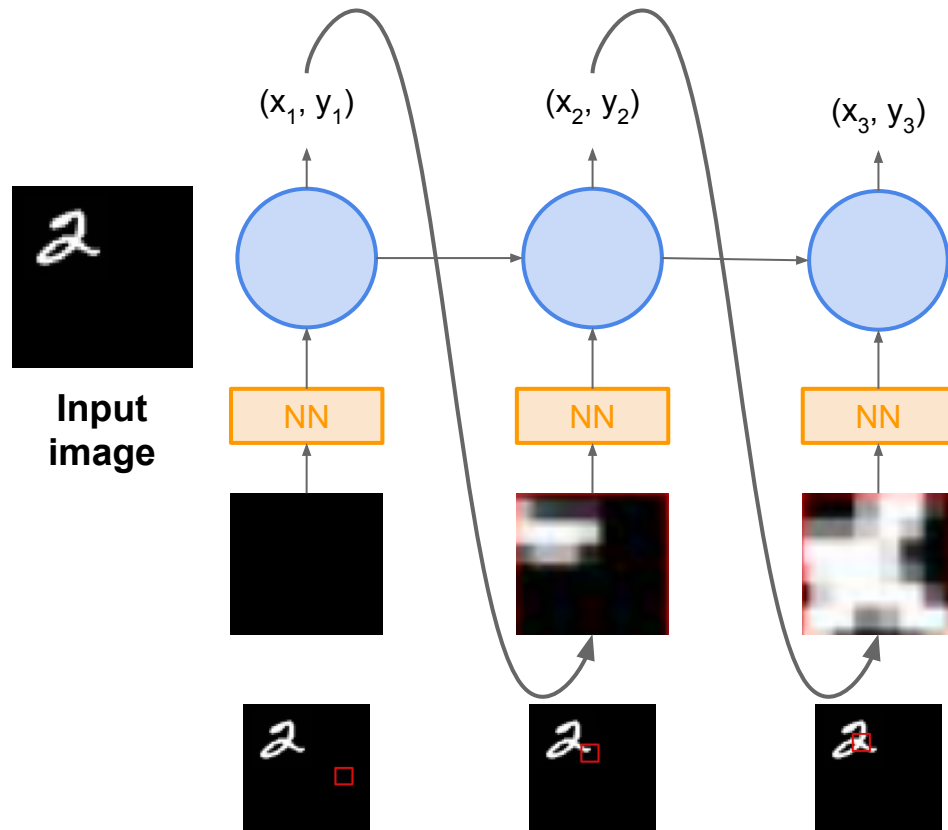

[Mnih et al. 2014]

REINFORCE in action: Recurrent Attention Model (RAM)

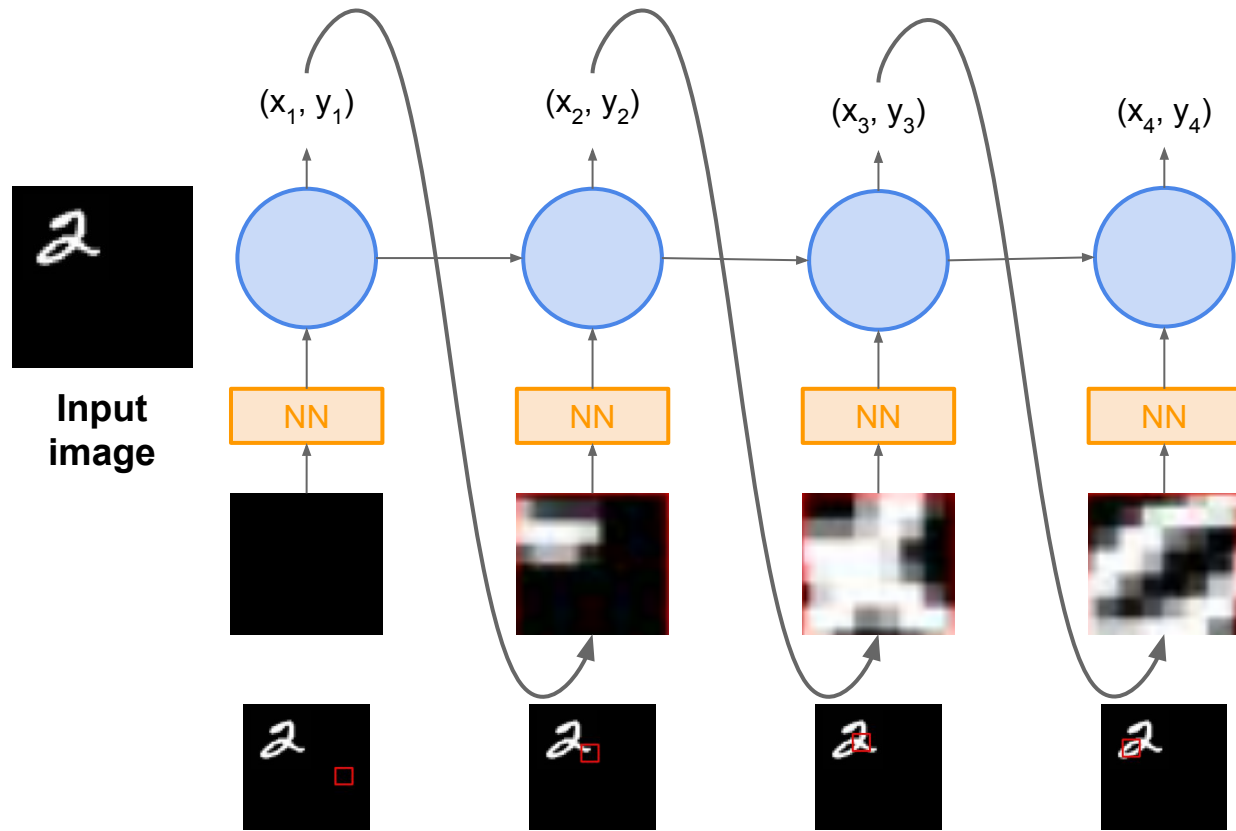

[Mnih et al. 2014]

REINFORCE in action: Recurrent Attention Model (RAM)

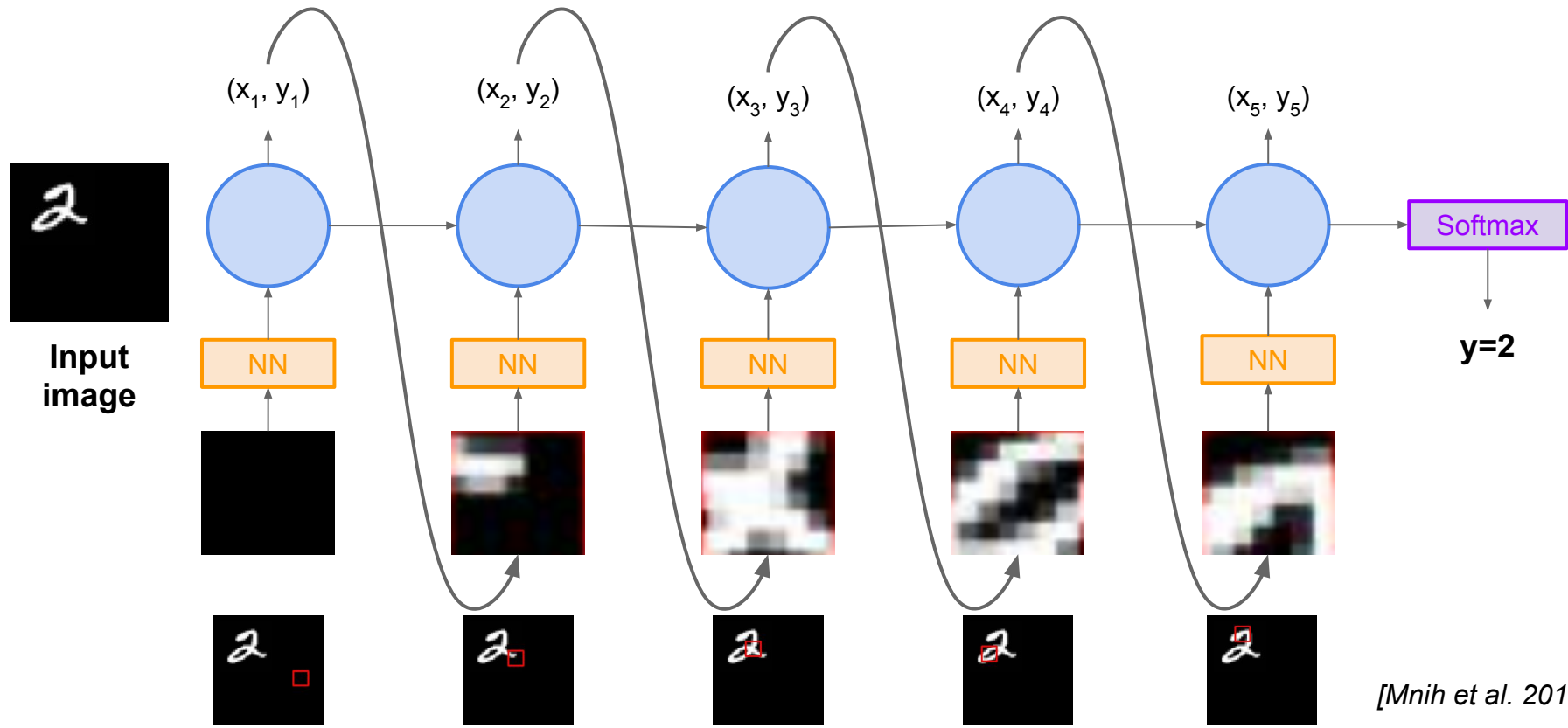

REINFORCE in action: Recurrent Attention Model (RAM)

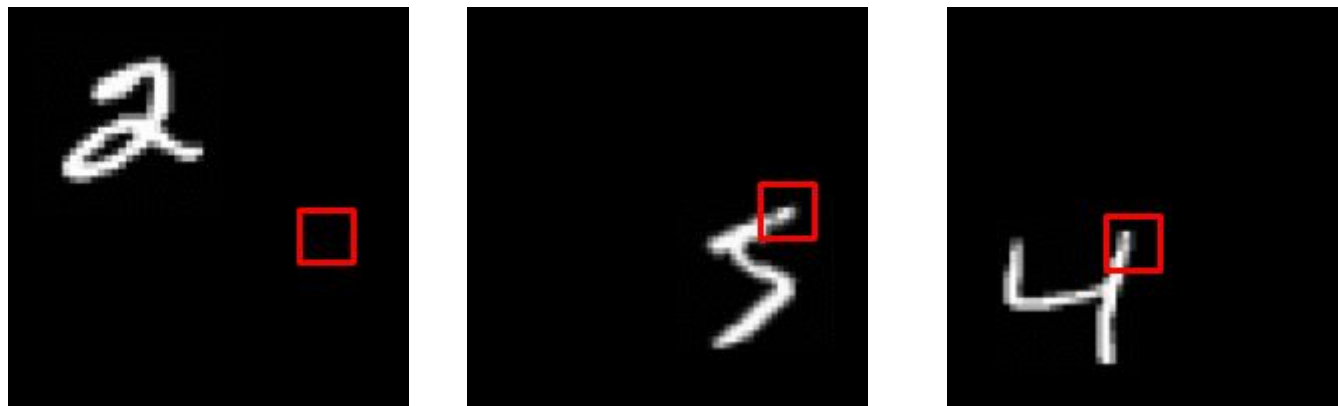

Has also been used in many other tasks including fine-grained image recognition, image captioning, and visual question-answering!

Figures copyright Daniel Levy, 2017. Reproduced with permission.

[Mnih et al. 2014]

More policy gradients: AlphaGo

Overview:

- Mix of supervised learning and reinforcement learning
- Mix of old methods (Monte Carlo Tree Search) and recent ones (deep RL)

How to beat the Go world champion:

- Featurize the board (stone color, move legality, bias, ...)
- Initialize policy network with supervised training from professional go games, then continue training using policy gradient (play against itself from random previous iterations, +1 / -1 reward for winning / losing)
- Also learn value network (critic)
- Finally, combine combine policy and value networks in a Monte Carlo Tree Search algorithm to select actions by lookahead search

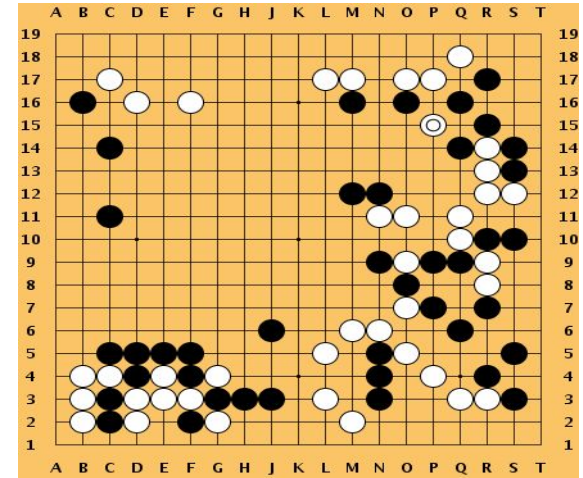

*[Silver et al.,
Nature 2016]*

This image is [CC0 public domain](#)

Summary

- **Policy gradients**: very general but suffer from high variance so requires a lot of samples. **Challenge**: sample-efficiency
- **Q-learning**: does not always work but when it works, usually more sample-efficient. **Challenge**: exploration
- Guarantees:
 - **Policy Gradients**: Converges to a local minima of $J(\theta)$, often good enough!
 - **Q-learning**: Zero guarantees since you are approximating Bellman equation with a complicated function approximator

Next Time



Segment Anything(05/25)

Ross Girshick

Research Scientist at Meta
Fundamental AI Research
(FAIR)