

# Network Components

# Parts of a Network

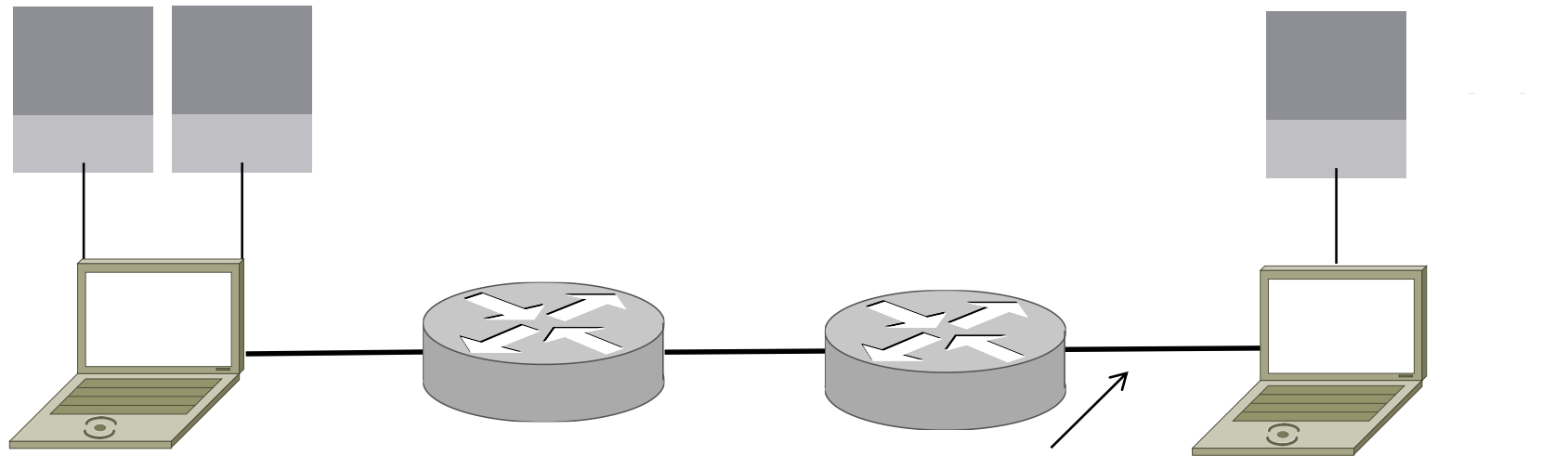

# Parts of a Network

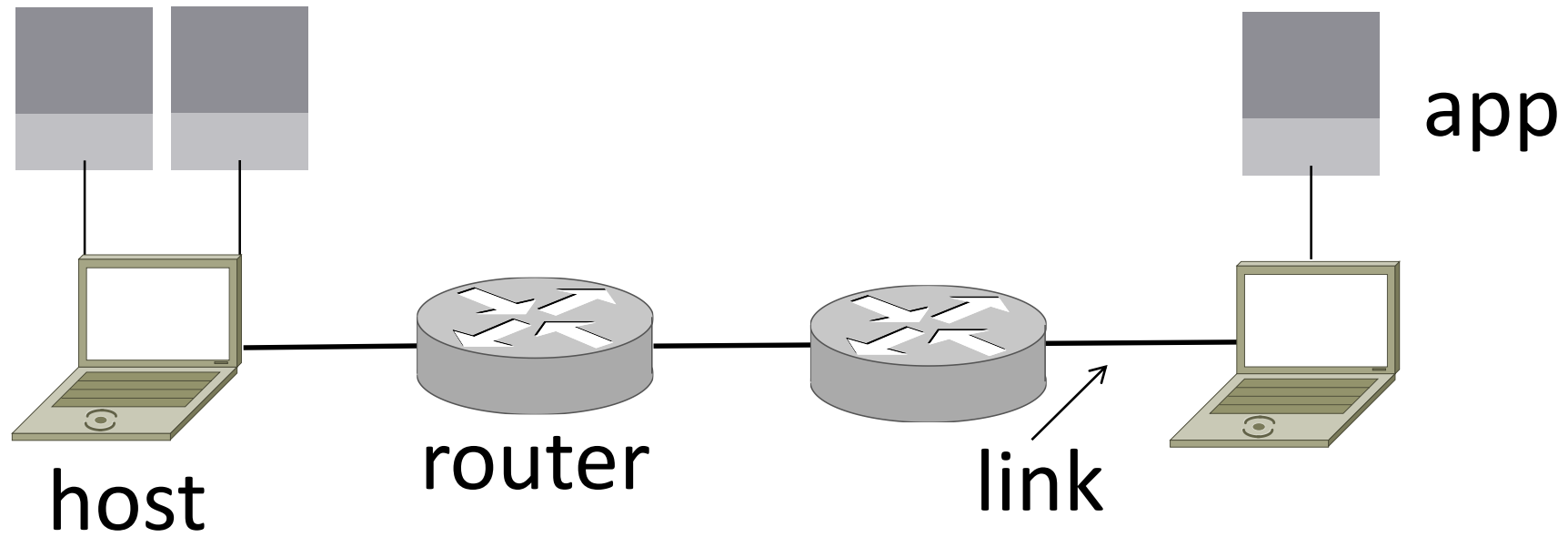

# Component Names

<b>Component</b>	<b>Function</b>	<b>Example</b>
<u>Application</u> , or app, user	Uses the network	Skype, iTunes, Amazon
<u>Host</u> , or end-system, edge device, node, source, sink	Supports apps	Laptop, mobile, desktop
<u>Router</u> , or switch, node, hub, intermediate system	Relays messages between links	Access point, cable/DSL modem
<u>Link</u> , or channel	Connects nodes	Wires, wireless

# Parts of a Network

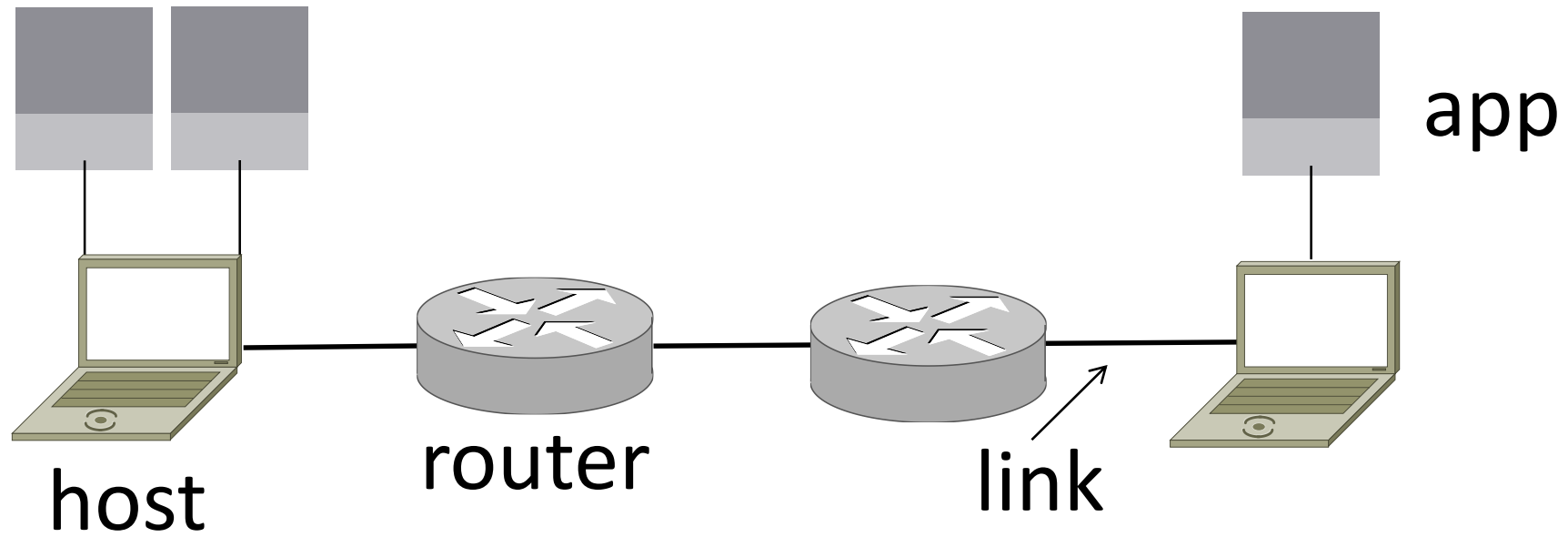

# Parts of a Network

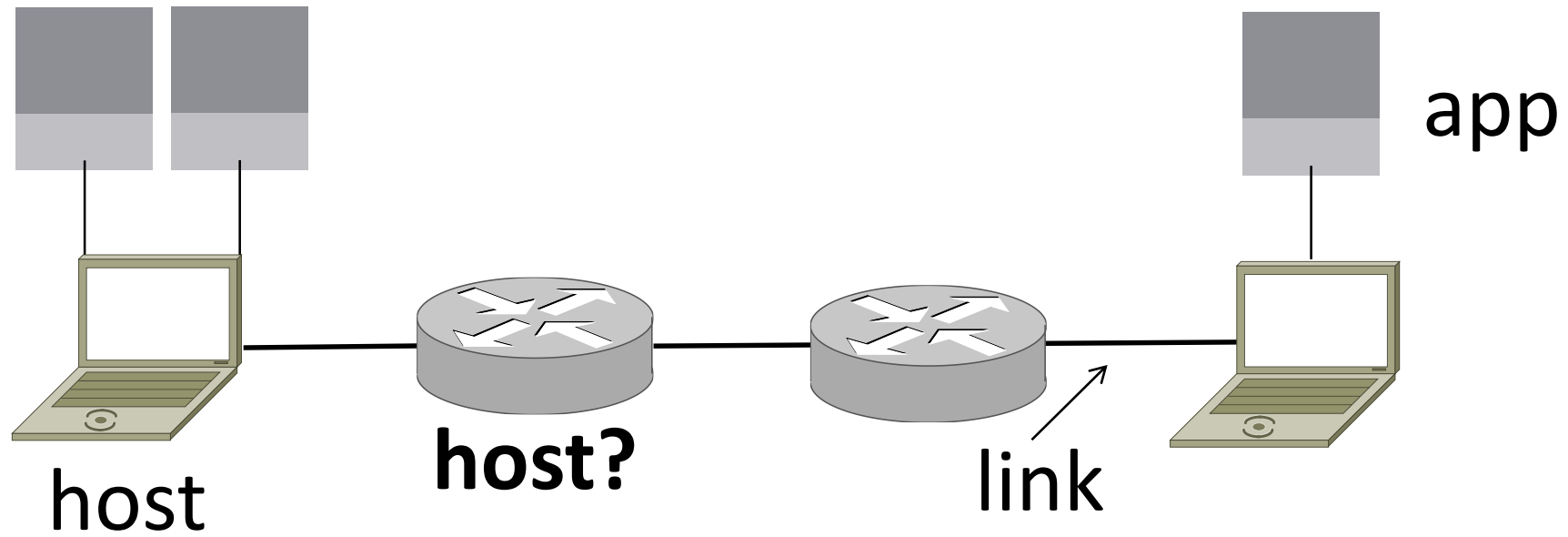

# Types of Links

- Full-duplex
  - Bidirectional
- Half-duplex
  - Bidirectional
- Simplex
  - unidirectional

# Wireless Links

- Message is broadcast
  - Received by all nodes in range
  - Not a good fit with our model

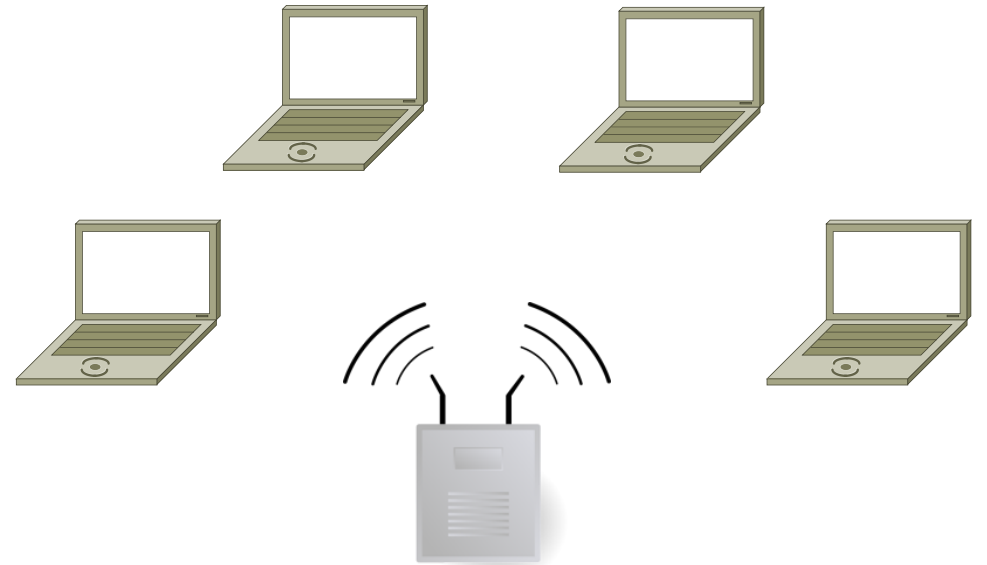



# Wireless Links (2)

- Often show logical links
  - Not all possible connectivity

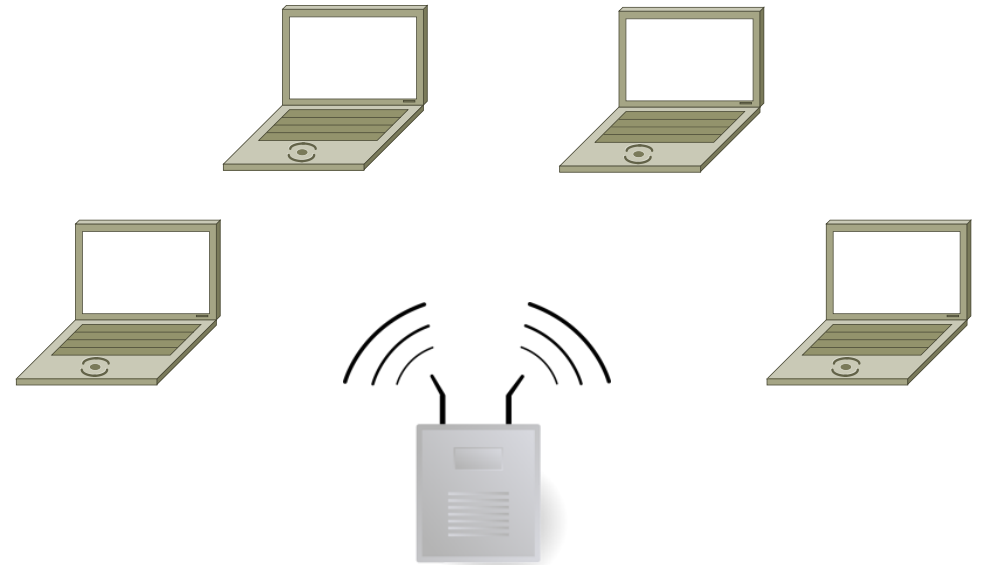

# A Small Network

- Connect a couple of computers

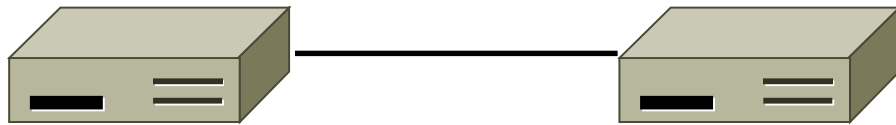

- Next, a large network ...

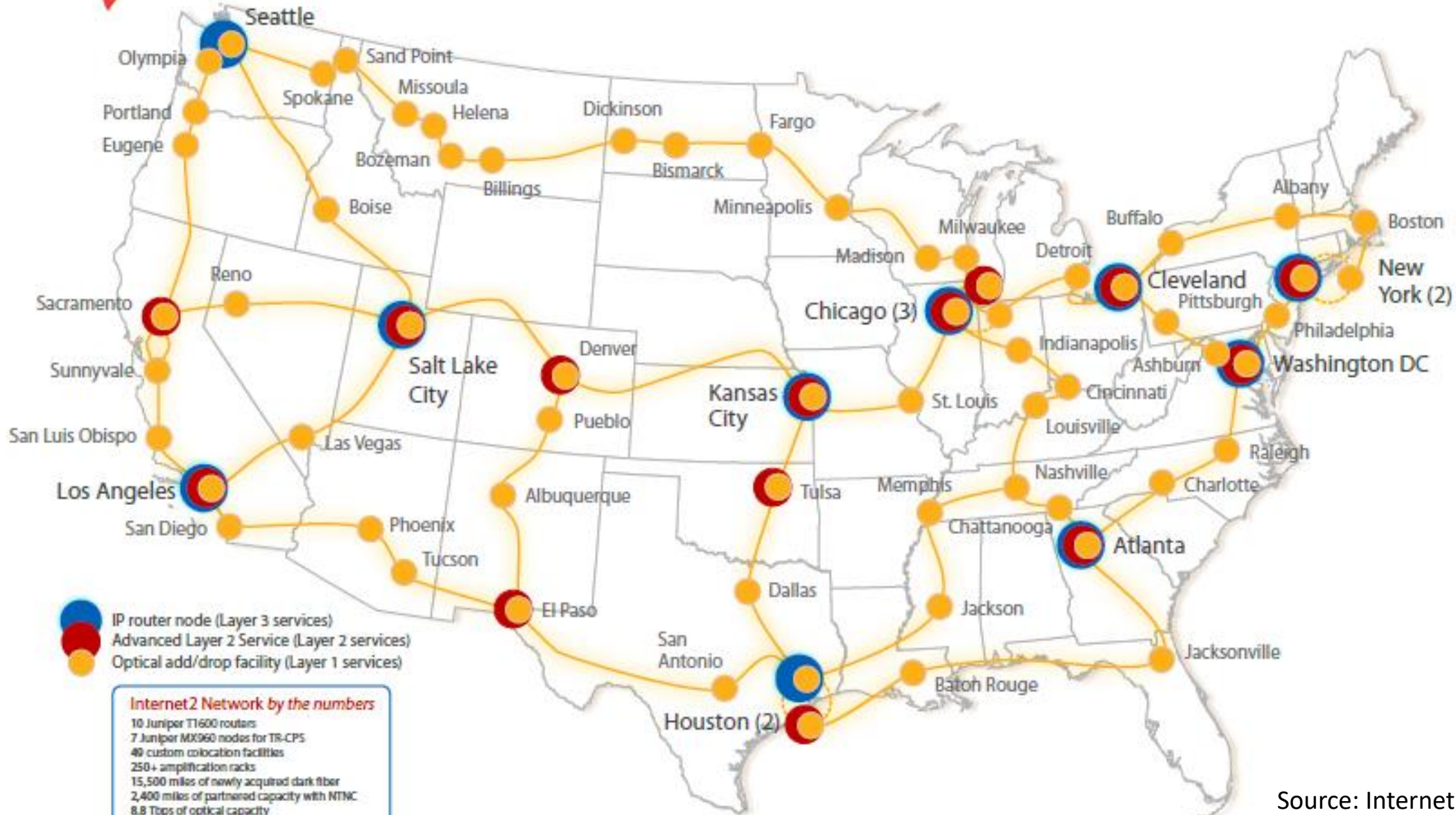

- IP router node (Layer 3 services)
- Advanced Layer 2 Service (Layer 2 services)
- Optical add/drop facility (Layer 1 services)

**Internet2 Network by the numbers**

- 10 Juniper T1600 routers
- 7 Juniper MX960 nodes for TR-CPS
- 40 custom colocation facilities
- 250+ amplification racks
- 15,500 miles of newly acquired dark fiber
- 2,400 miles of partnered capacity with NTNC
- 8.8 Tbps of optical capacity
- 100 Gbps of IP capacity
- 300+ Ciena ActiveFlex 6500 network elements

IN SUPPORT OF  
**U.S.UCAN**

NETWORK PARTNERS

**ciena**

**CISCO**

**INDIANA UNIVERSITY**

**Infinera**

**JUNIPER NETWORKS**

Source: Internet2

# Example Networks

- WiFi (802.11)
- Enterprise / Ethernet
- ISP (Internet Service Provider)
- Cable / DSL
- Mobile phone / cellular (2G, 3G, 4G)
- Bluetooth
- Telephone
- Satellite ...

# Network names by scale

<b>Scale</b>	<b>Type</b>	<b>Example</b>
Vicinity	<u>PAN</u> (Personal Area Network)	Bluetooth (e.g., headset)
Building	<u>LAN</u> (Local Area Network)	WiFi, Ethernet
City	<u>MAN</u> (Metropolitan Area Network)	Cable, DSL
Country	<u>WAN</u> (Wide Area Network)	Large ISP
Planet	The Internet (network of all networks)	The Internet!

# Internetworks

- An internetwork, or internet, is what you get when you join networks together
  - Just another network
- The Internet (capital “I”) is the internet we all use

# Network Boundaries

- What part is the “network”?

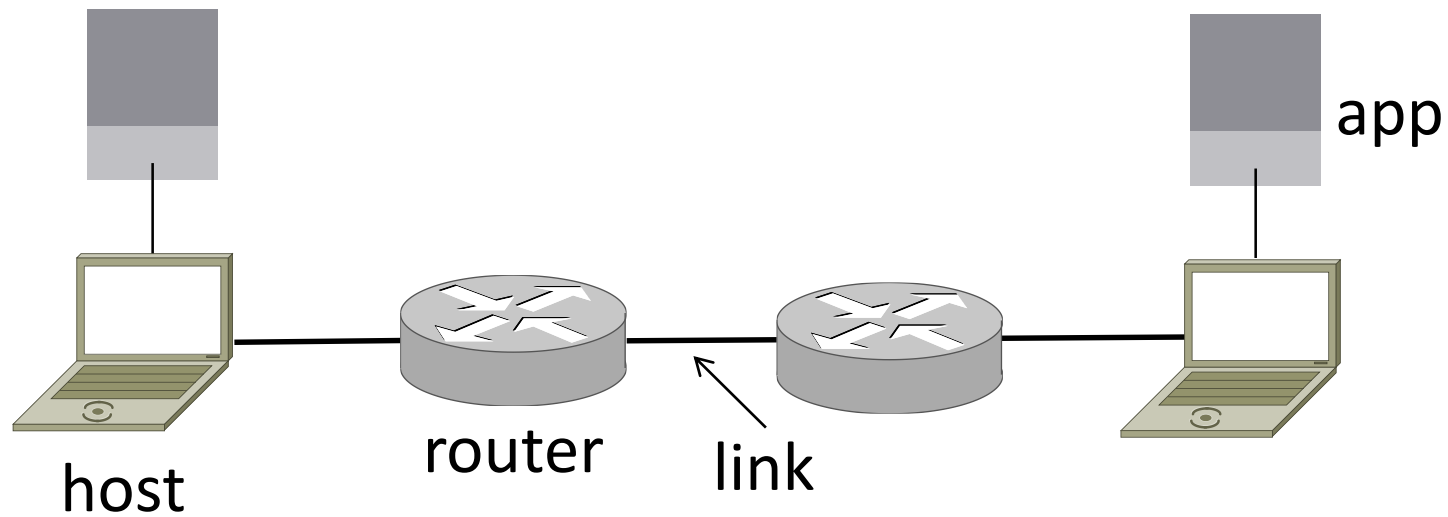

# Network Boundaries (2)

- What part represents an “ISP”?

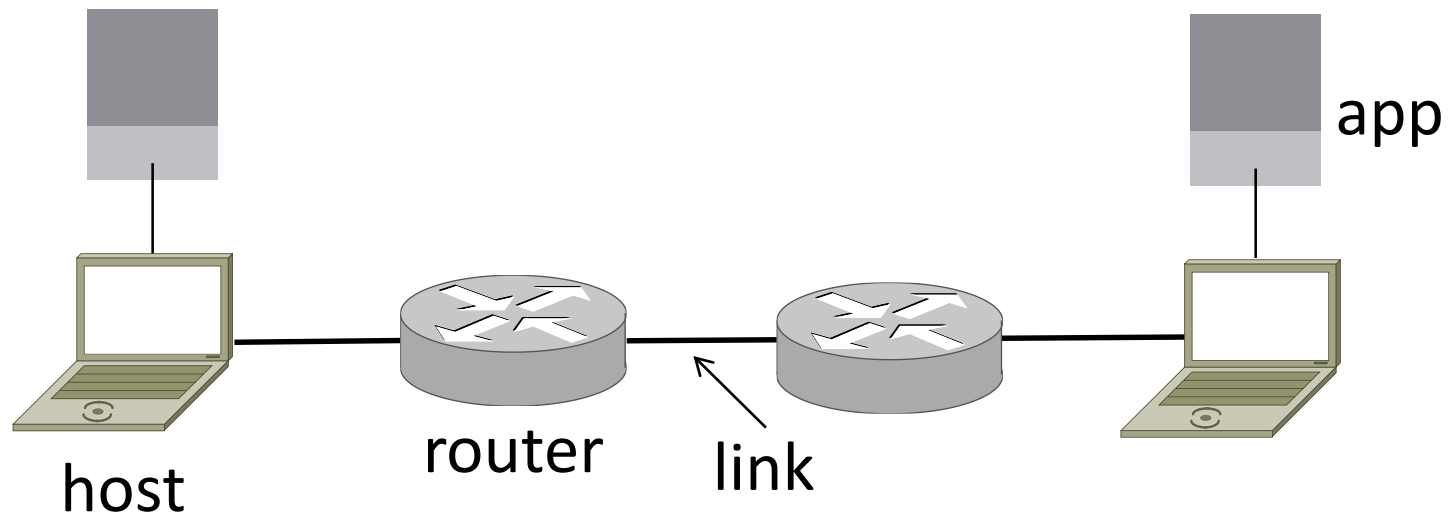



# Network Boundaries (3)

- Cloud as a generic network



# Key Interfaces

- Between (1) apps and network, and (2) network components

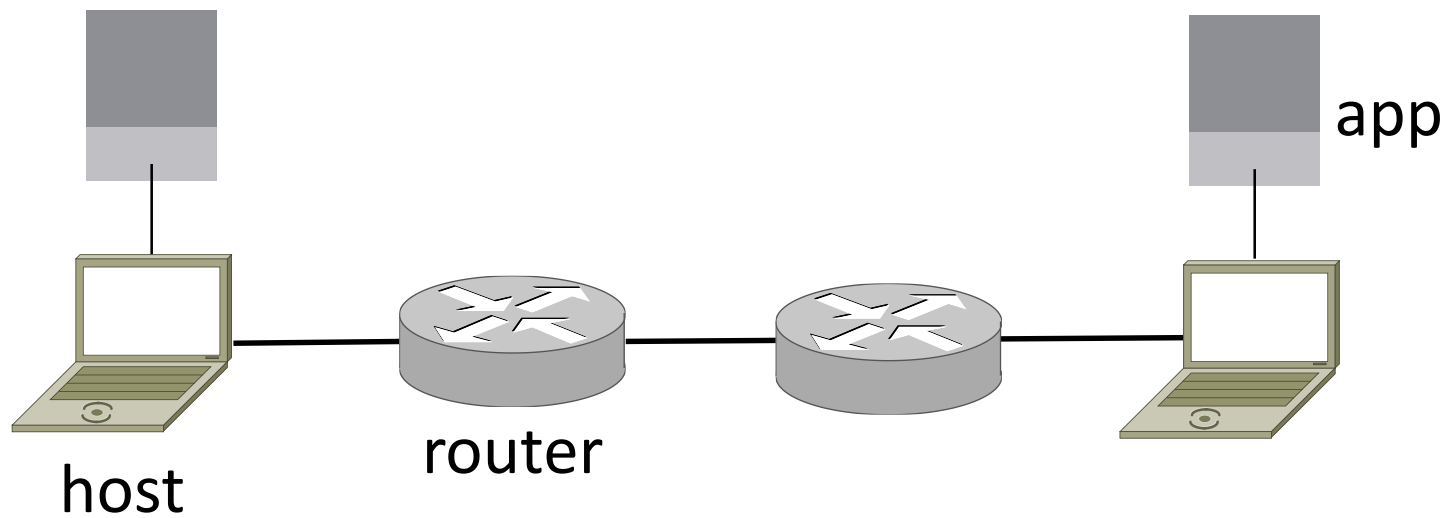

# Networks Need Modularity

- The network does much for apps:
  - Make and break connections
  - Find a path through the network
  - Transfers information reliably
  - Transfers arbitrary length information
  - Send as fast as the network allows
  - Shares bandwidth among users
  - Secures information in transit
  - Lets many new hosts be added
  - ...

# Networks Need Modularity

- The network does much for apps:

**We need a form of modularity, to help manage complexity and support reuse**

- Secures information in transit
- Lets many new hosts be added
- ...

# Protocols and Layers

- Protocols and layering is the main structuring method used to divide up network functionality
  - Each instance of a protocol talks virtually to its peer using the protocol
  - Each instance of a protocol uses only the services of the lower layer

# Protocols and Layers (2)

- Protocols are horizontal, layers are vertical

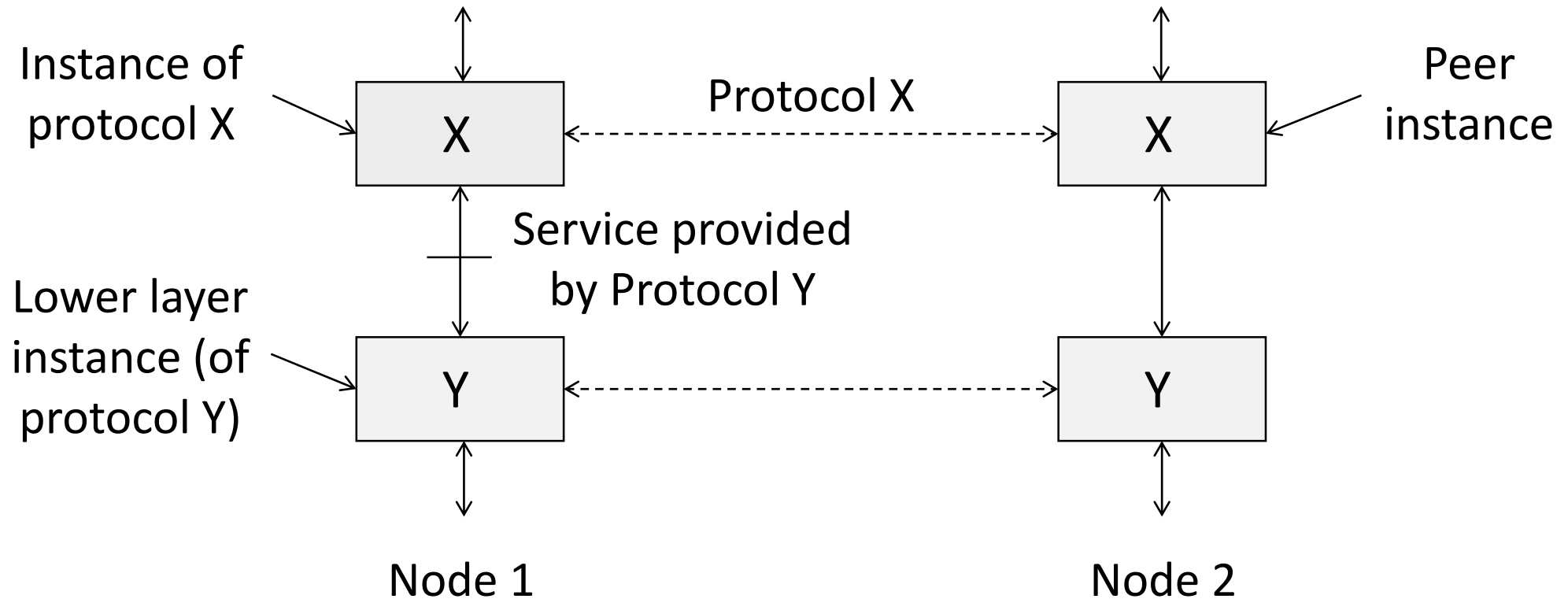

# Protocols and Layers (3)

- Set of protocols in use is called a protocol stack

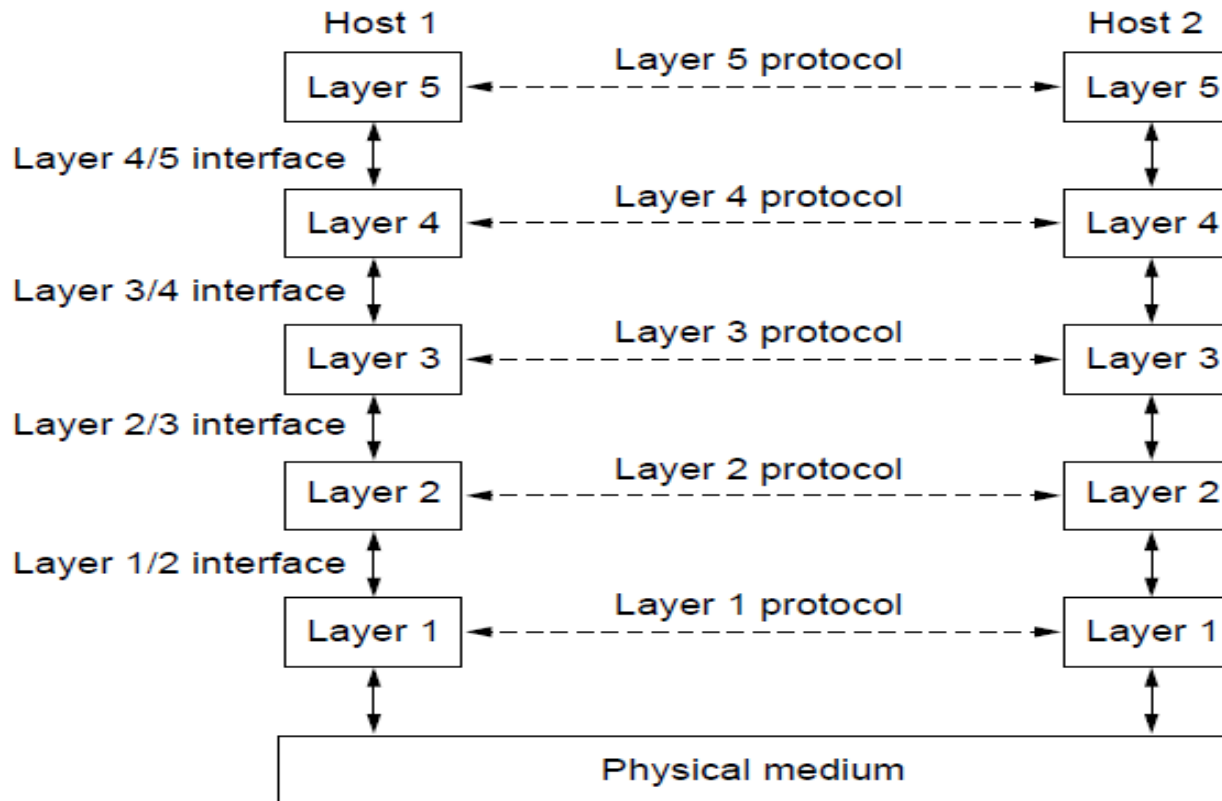

# Protocols and Layers (4)

- Protocols you've probably heard of:
  - TCP, IP, 802.11, Ethernet, HTTP, SSL, DNS, ... and many more



# Protocols and Layers (5)

- Protocols you've probably heard of:
  - TCP, IP, 802.11, Ethernet, HTTP, SSL, DNS, ... and many more
- An example protocol stack
  - Used by a web browser on a host that is wirelessly connected to the Internet

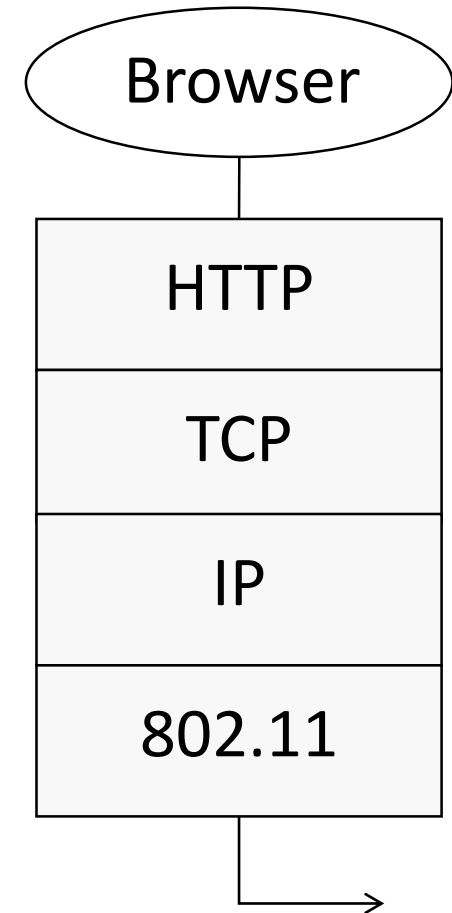

# Encapsulation

- Encapsulation is the mechanism used to effect protocol layering
  - Lower layer wraps higher layer content, adding its own information to make a new message for delivery
  - Like sending a letter in an envelope; postal service doesn't look inside

# Encapsulation (2)

- Message “on the wire” begins to look like an onion
  - Lower layers are outermost

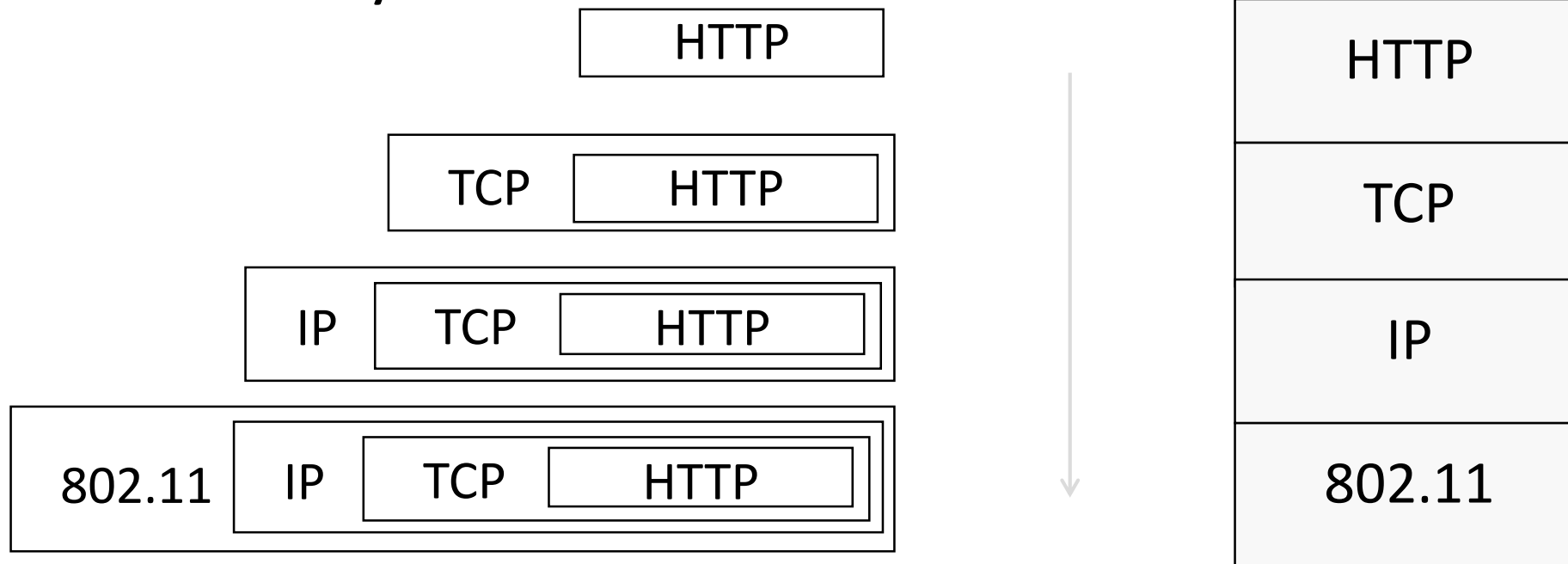

# Encapsulation (3)

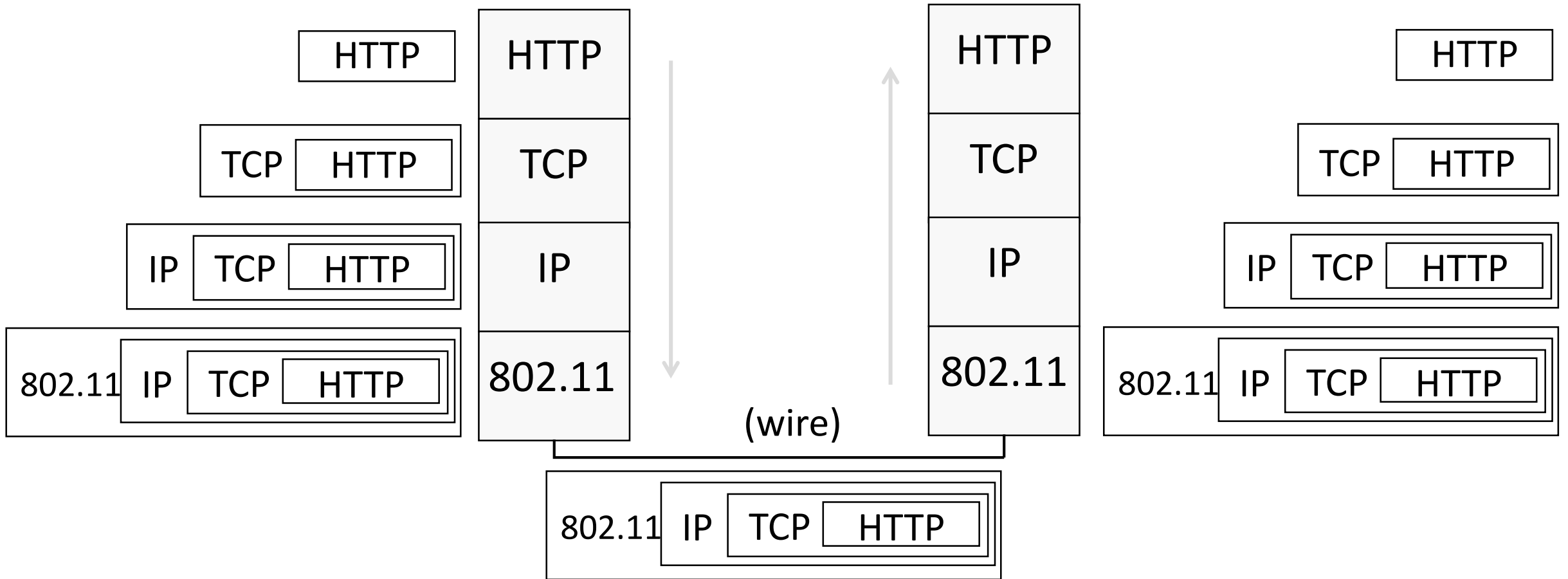

# Encapsulation (4)

- Normally draw message like this:
  - Each layer adds its own header

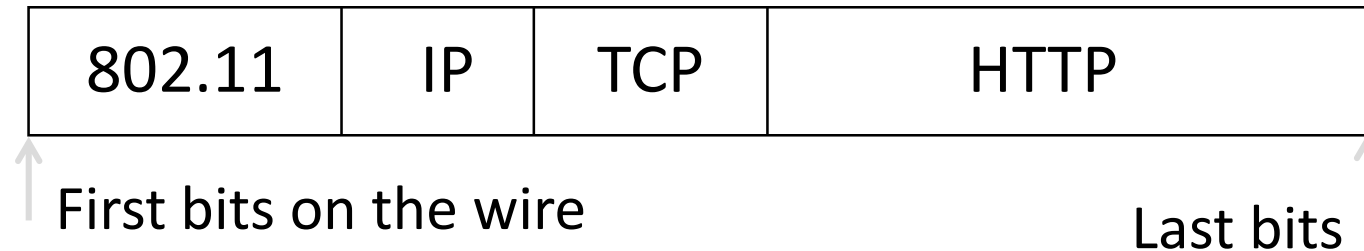

- More involved in practice
  - Trailers as well as headers, encrypt/compress contents
  - Segmentation (divide long message) and reassembly

# Demultiplexing

- Incoming message must be passed to the protocols that it uses

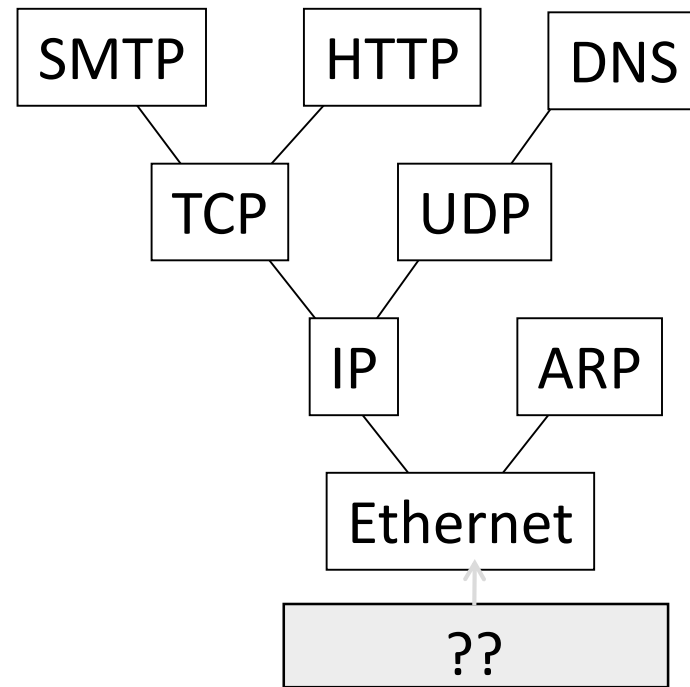

# Demultiplexing (2)

- Done with demultiplexing keys in the headers

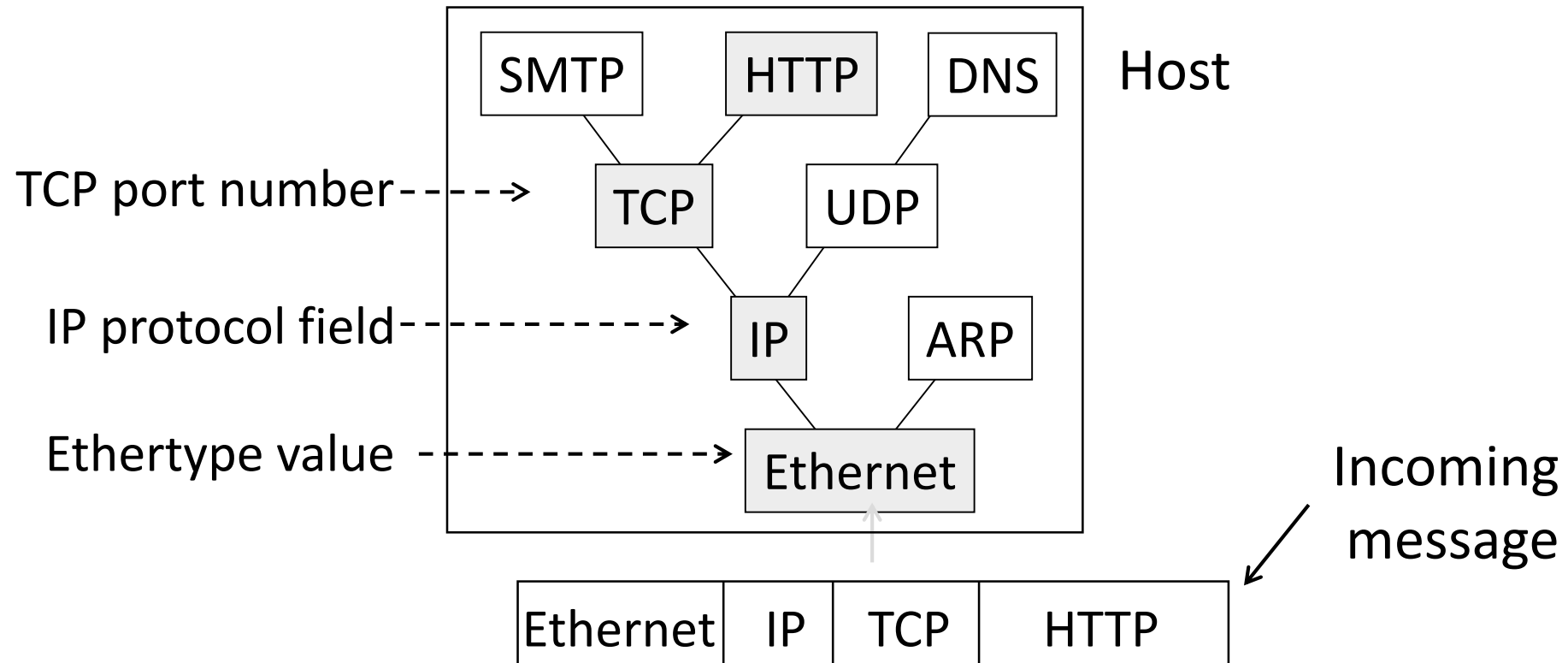

# Advantage of Layering

- Information hiding and reuse

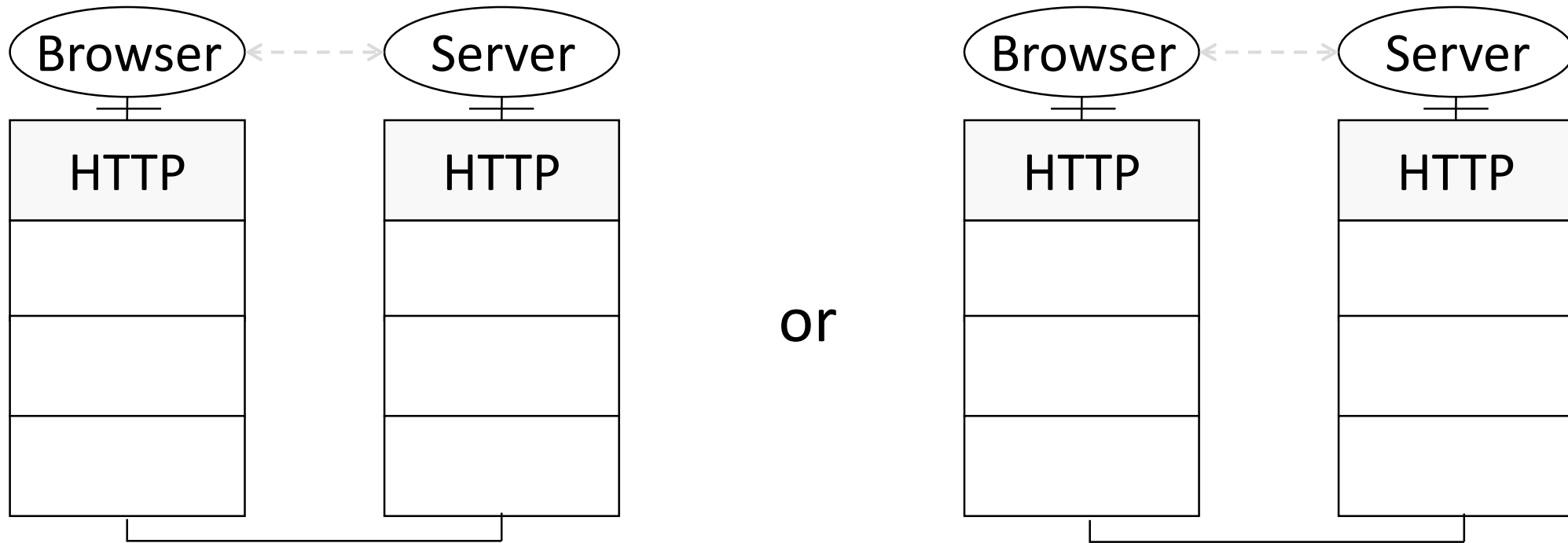



# Advantage of Layering (2)

- Information hiding and reuse

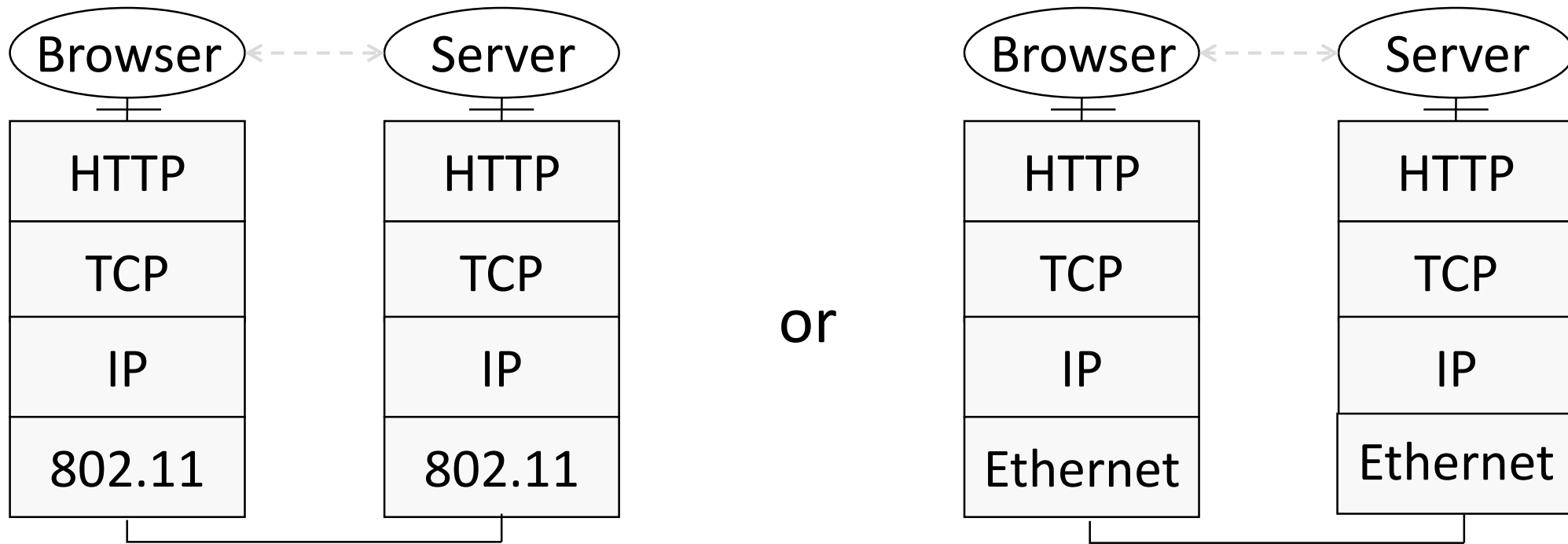

# Advantage of Layering (3)

- Using information hiding to connect different systems



# Advantage of Layering (4)

- Information hiding to connect different systems

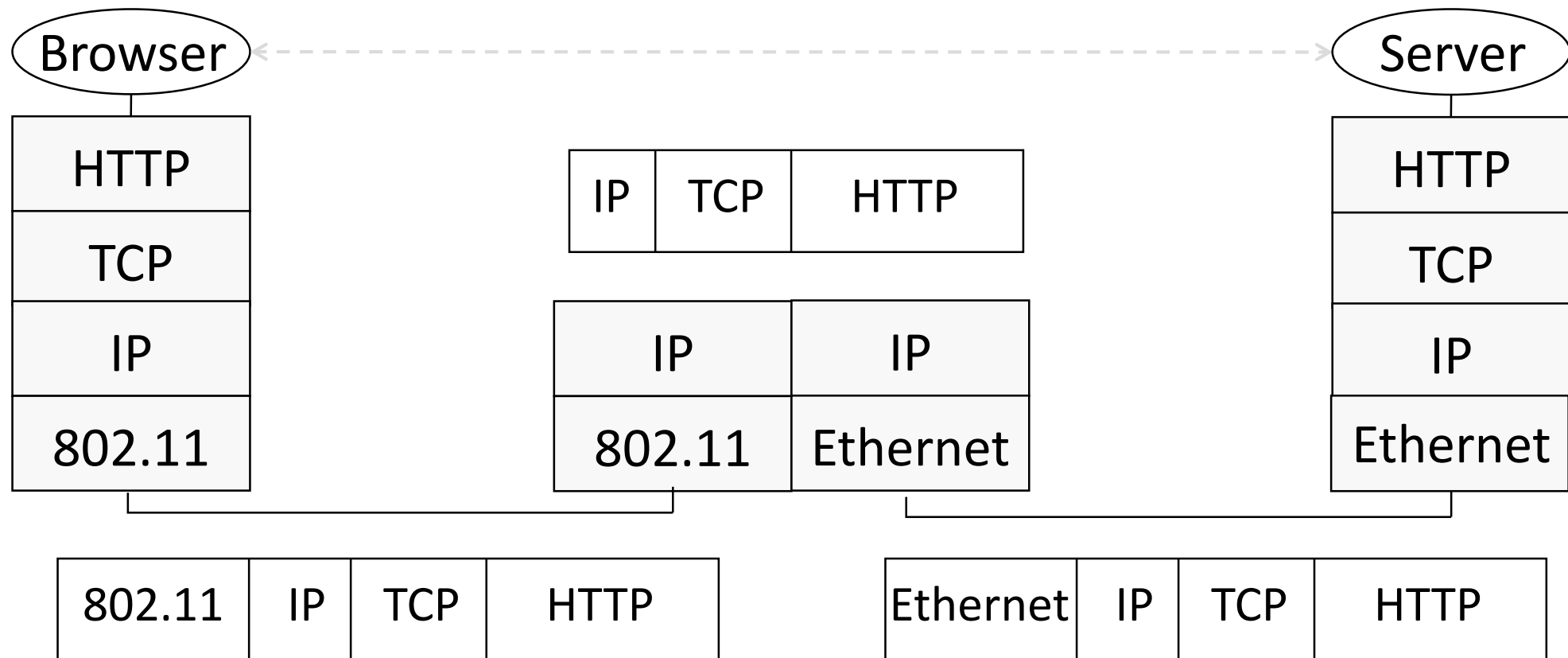

# Advantage of Layering (5)

- Information hiding to connect different systems

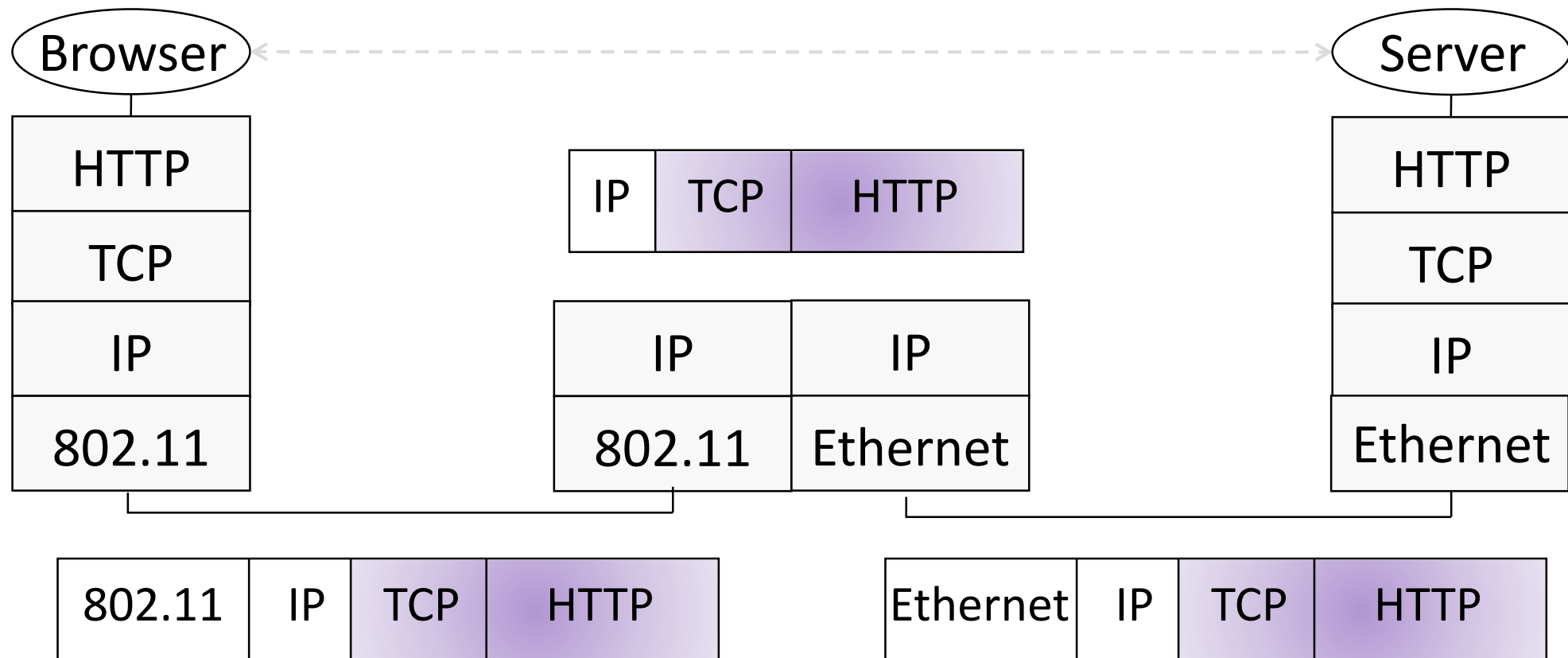

# Disadvantages of Layering

- ?

# Disadvantage of Layering

- Adds overhead
  - More problematic with short messages
- Hides information
  - App might care about network properties (e.g., latency, bandwidth, etc)
  - Network may need to know about app priorities (e.g., QoS)

# OSI Layers

Layer	Function	Example
<b>Application (7)</b>	Services that are used with end user applications	SMTP,
<b>Presentation (6)</b>	Formats the data so that it can be viewed by the user  Encrypt and decrypt	JPG, GIF, HTTPS, SSL, TLS
<b>Session (5)</b>	Establishes/ends connections between two hosts	NetBIOS, PPTP
<b>Transport (4)</b>	Responsible for the transport protocol and error handling	TCP, UDP
<b>Network (3)</b>	Reads the IP address from the packet.	Routers, Layer 3 Switches
<b>Data Link (2)</b>	Reads the MAC address from the data packet	Switches
<b>Physical (1)</b>	Send data on to the physical wire.	Hubs, NICs, Cable

# Protocols and Layering

- The real internet protocol stacks:

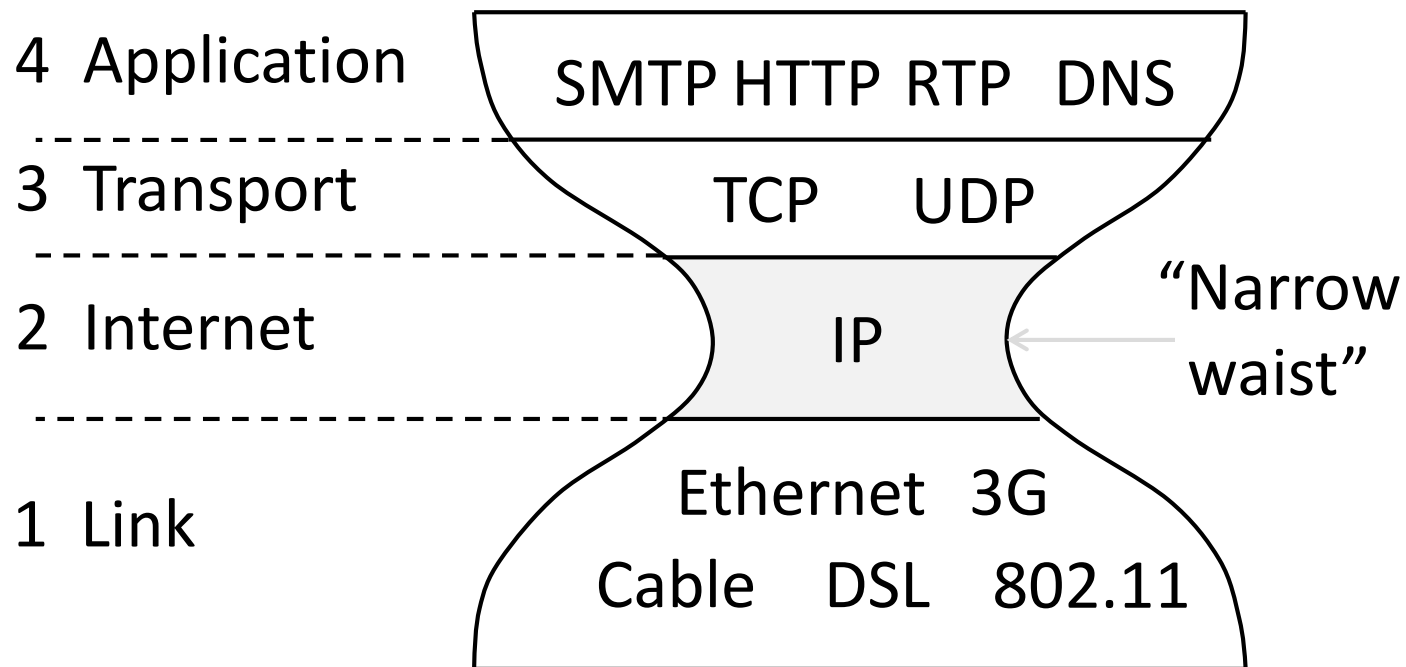



# Course Reference Model

- We mostly follow the Internet
  - A little more about the Physical layer, and alternatives

5	Application	– Programs that use network service
4	Transport	– Provides end-to-end data delivery
3	Network	– Send packets over multiple networks
2	Link	– Send frames over one or more links
1	Physical	– Send bits using signals

# Lecture Progression

- Bottom-up through the layers:

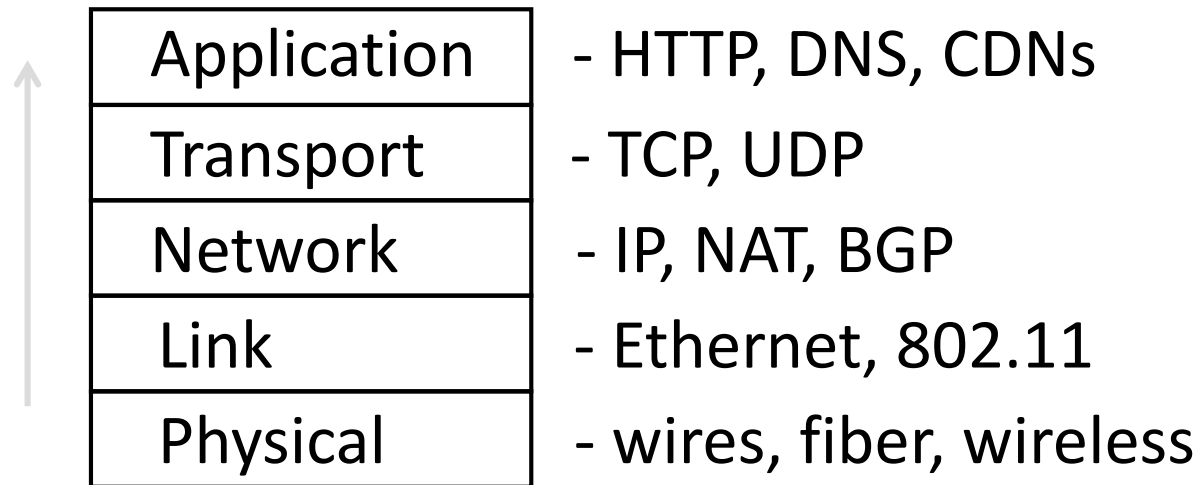

- Followed by more detail on:
  - Quality of service, Security (VPN, SSL)