

Texture Mapping

**Adriana Schulz
CSE 457
Fall 2020**

Reading

Optional

- ◆ Angel and Shreiner: 7.4-7.10
- ◆ Marschner and Shirley: 11.1-11.2.3, 11.2.5, 11.4-11.5

Further reading

- ◆ Paul S. Heckbert. Survey of texture mapping. **IEEE Computer Graphics and Applications** 6(11): 56--67, November 1986.
- ◆ Woo, Neider, & Davis, Chapter 9
- ◆ James F. Blinn and Martin E. Newell. Texture and reflection in computer generated images. **Communications of the ACM** 19(10): 542--547, October 1976.

Texture mapping



Texture mapping (Woo et al., fig. 9-1)

Texture mapping allows you to take a simple polygon and give it the appearance of something much more complex.

- ◆ Due to Ed Catmull, PhD thesis, 1974
- ◆ Refined by Blinn & Newell, 1976

A texture can modulate just about any parameter – diffuse color, specular color, specular exponent,

...

Implementing texture mapping

A texture lives in its own abstract image coordinates parameterized by (u, v) in the range $([0..1], [0..1])$:

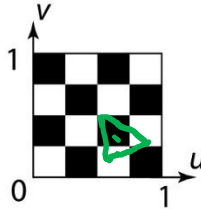

It can be wrapped around many different surfaces:

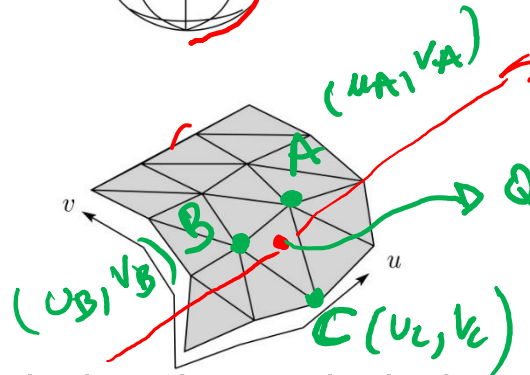
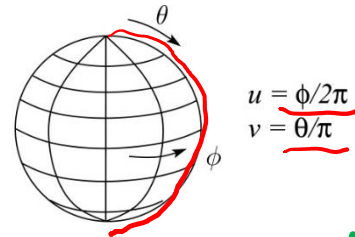
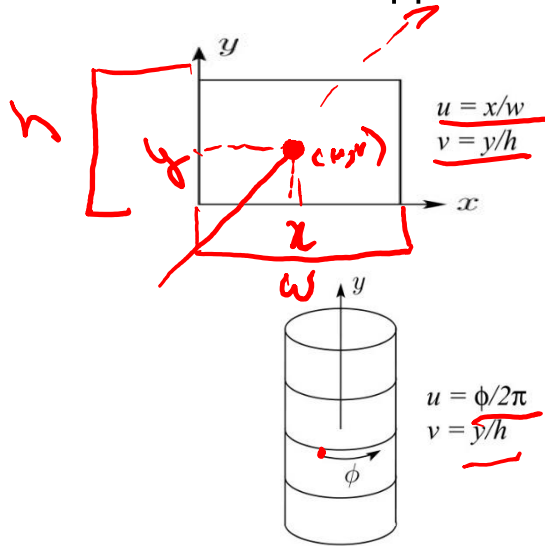

$$Q = \alpha A + \beta B + \gamma C$$

$$Q(u, v) = \alpha(u_1, v_1) + \beta(u_2, v_2) + \gamma(u_3, v_3)$$

With a ray caster, we can do the sphere and cylinder mappings directly (as we will see later). For graphics hardware, everything gets converted to a triangle mesh with associated (u, v) coordinates.

Note: if the surface moves/deforms, the texture goes with it.

Texture coordinates on a surface of revolution

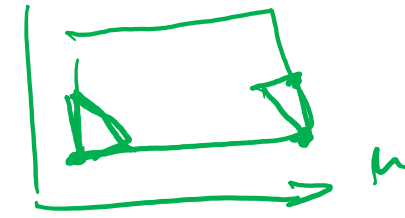
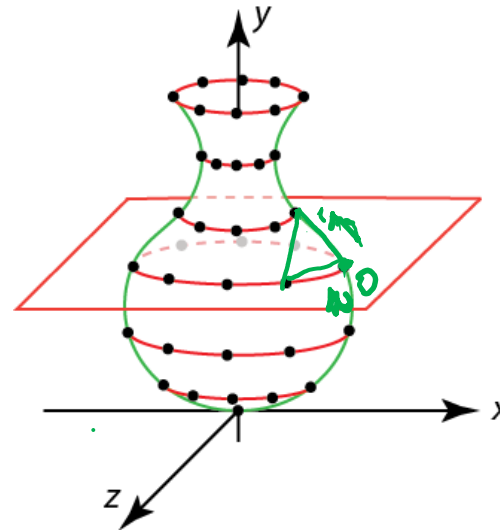
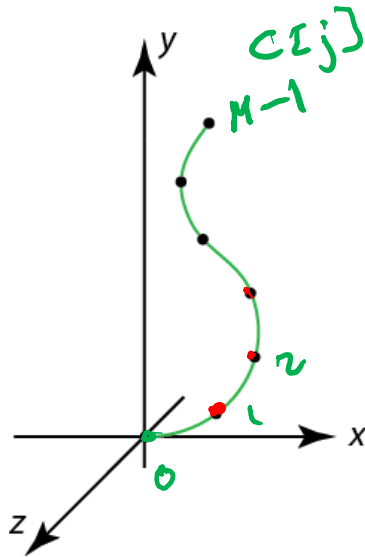

Recall that for a surface of revolution, we have:

Profile curve: $C[j]$ where $j \in [0..M-1]$

Rotation angles: $\theta[i] = 2\pi i / N$ where $i \in [0..N]$

The simplest assignment of texture coordinates would be:

$$u = \frac{i}{N}$$

~~$$v = \frac{j}{M-1}$$~~

Note that you should include the rotation angles for $i = 0$ and $i = N$, even though they produce the same points (after rotating by 0 and 2π). Why do this??



Texture coordinates on a surface of revolution

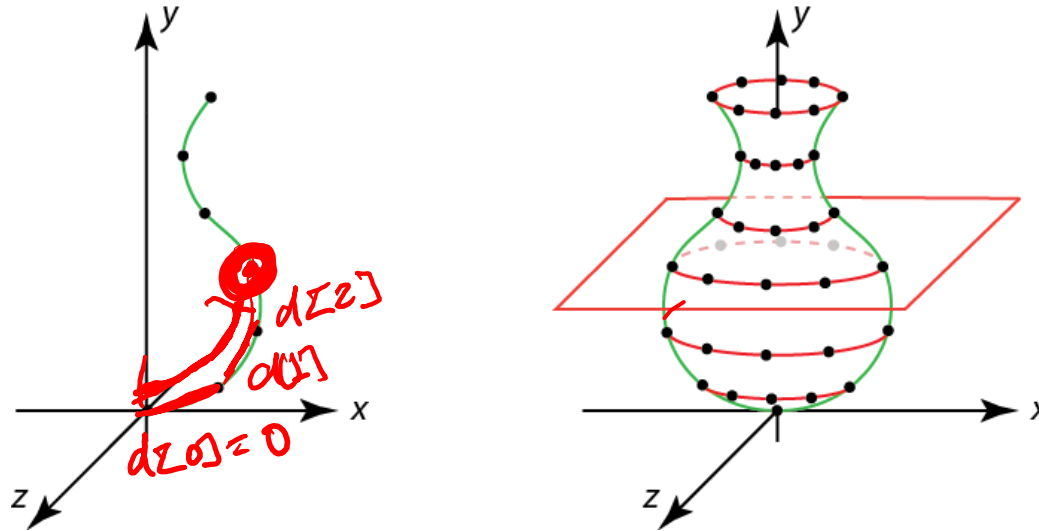

If we wrap an image around this surface of revolution, what artifacts would we expect to see?

We can reduce distortion in v . Define:

$$d[j] = \begin{cases} \|C[j] - C[j-1]\|, & \text{if } j \neq 0 \\ 0, & \text{if } j = 0 \end{cases}$$

and set v to fractional distance along the curve:

$$v = \frac{\sum_{k=0}^j d[k]}{\sum_{k=0}^{n-1} d[k]}$$

DO THIS!

You must do this for v for the programming assignment!

Mapping to texture image coords

The texture is usually stored as an image. Thus, we need to convert from abstract texture coordinate:

$$(u, v) \text{ in the range } ([0..1], [0..1])$$

to texture image coordinates:

$$(u_{tex}, v_{tex}) \text{ in the range } ([0.. w_{tex}], [0.. h_{tex}])$$

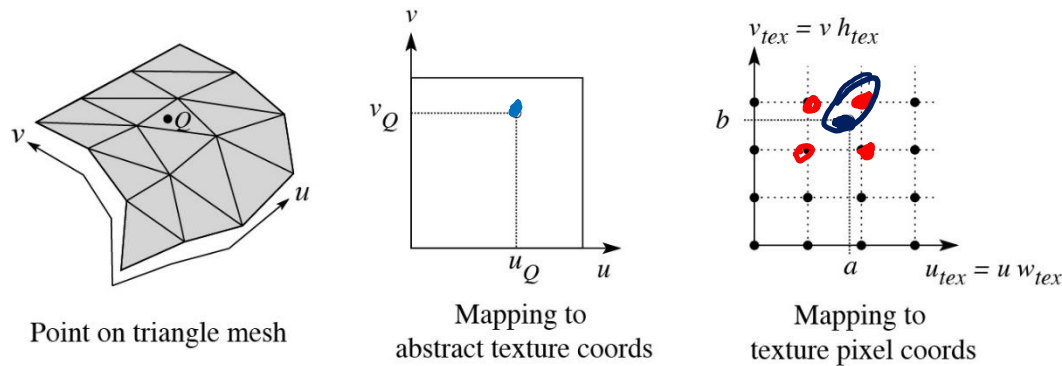

Q: What do you do when the texture sample you need lands between texture pixels?

Texture resampling

We need to resample the texture:

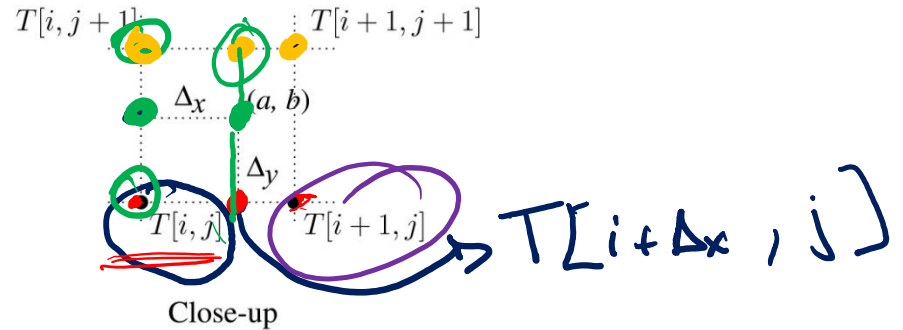
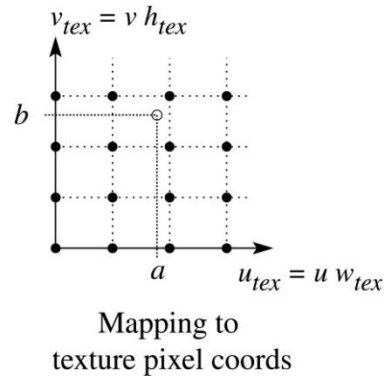

Thus, we seek to solve for: $T(a, b) = T(i + D_x, j + D_y)$

A common choice is **bilinear interpolation**:

$$T(i + \Delta_x, j) = \frac{(1 - \Delta_x)}{\Delta_x} T[i, j] + \frac{\Delta_x}{\Delta_x} T[i + 1, j]$$

$$T(i + \Delta_x, j + 1) = \frac{(1 - \Delta_x)}{\Delta_x} T[i, j + 1] + \frac{\Delta_x}{\Delta_x} T[i + 1, j + 1]$$

$$T(i + \Delta_x, j + \Delta_y) = \frac{(1 - \Delta_y)}{\Delta_y} T(i + \Delta_x, j) + \frac{\Delta_y}{\Delta_y} T(i + \Delta_x, j + 1)$$

$$= \frac{(1 - \Delta_x)(1 - \Delta_y)}{\Delta_x \Delta_y} T[i, j] + \frac{\Delta_x (1 - \Delta_y)}{\Delta_x \Delta_y} T[i + 1, j] +$$

$$\frac{(1 - \Delta_x) \Delta_y}{\Delta_x \Delta_y} T[i, j + 1] + \frac{\Delta_x \Delta_y}{\Delta_x \Delta_y} T[i + 1, j + 1]$$

Texture mapping and rasterization

Texture-mapping can also be handled in rasterization algorithms.

Method:

- ◆ Scan conversion is done in screen space, as usual
- ◆ Each pixel is colored according to the texture
- ◆ Texture coordinates are found by Gouraud-style interpolation

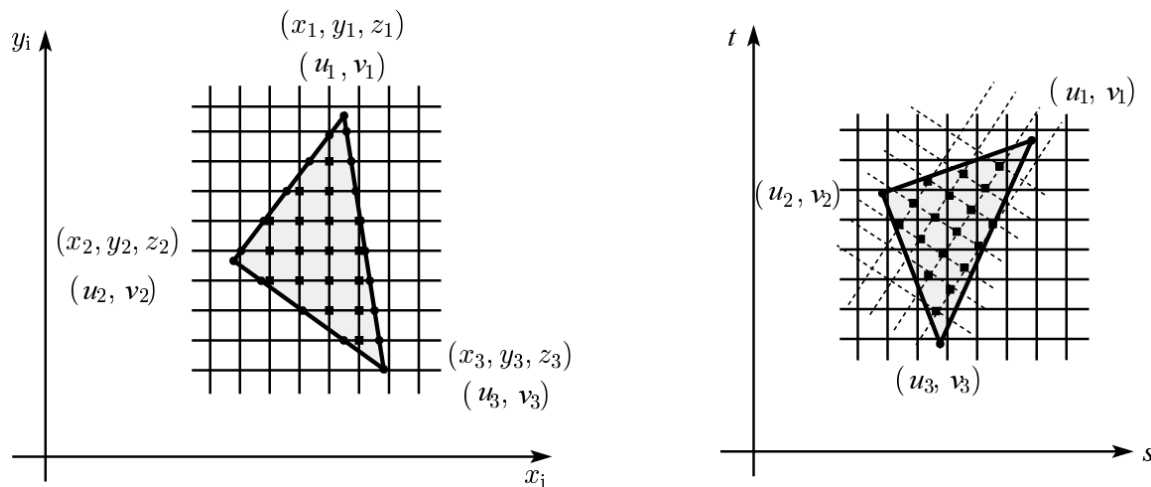

Note: Mapping is more complicated to handle perspective correctly.

Displacement mapping

Textures can be used for more than just color.

In **displacement mapping**, a texture is used to perturb the surface geometry itself. Here's the idea in 2D:

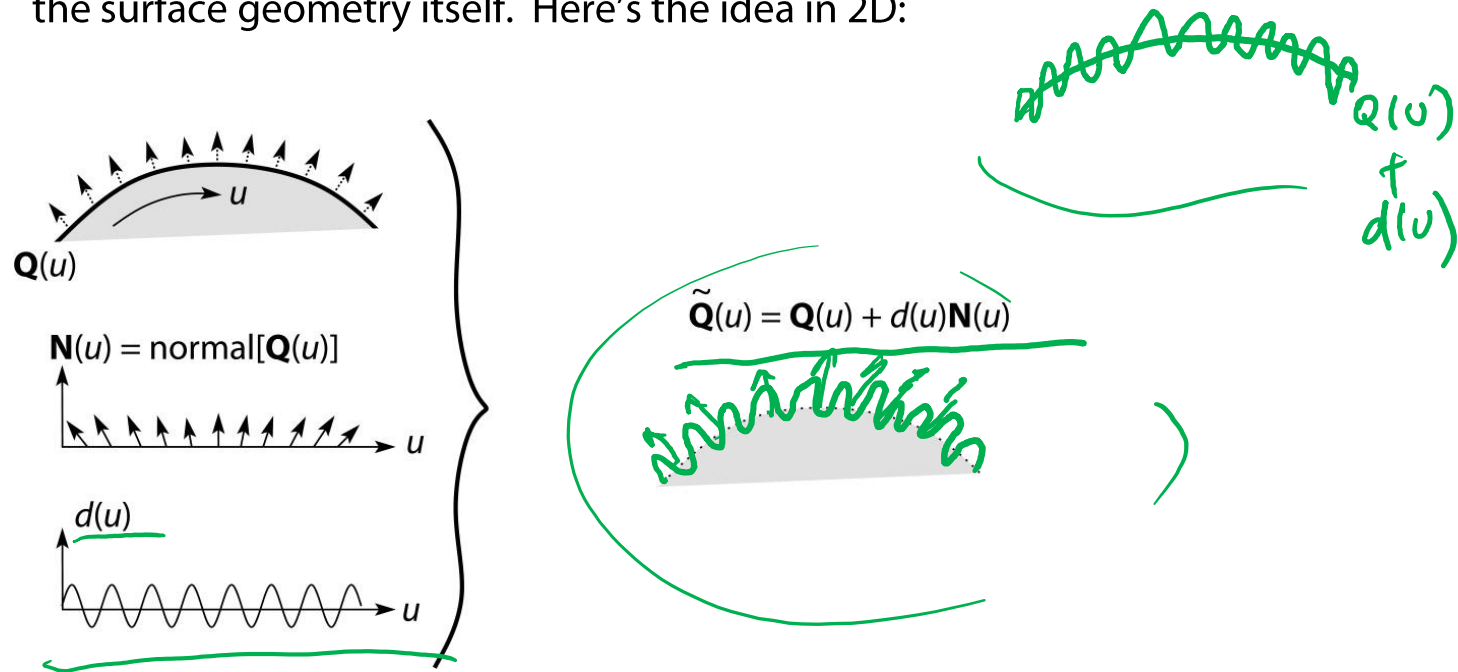

- ◆ These displacements “animate” with the surface
- ◆ In 3D, you would of course have (u, v) parameters instead of just u .

Suppose Q is a simple surface, like a cube. Will it take more work to render the modified surface \tilde{Q} ?

Bump and normal mapping

In **bump mapping**, a texture is used to perturb the normal:

- ◆ Use the original, simpler geometry, $\mathbf{Q}(u)$, for hidden surfaces
- ◆ Use the normal from the displacement map for shading:

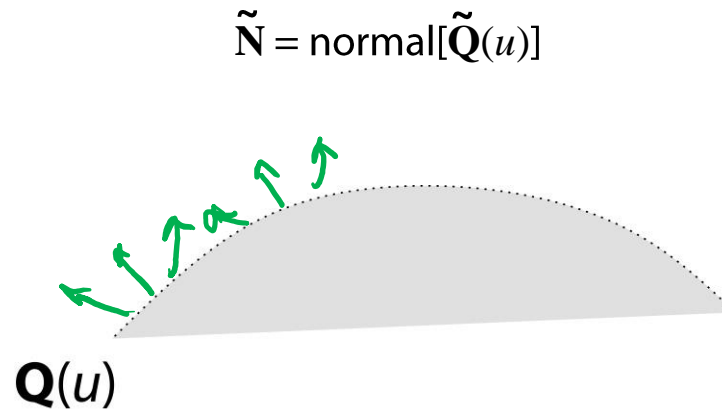

An alternative is to compute the normals from the original bump map height field and map them over the smooth surface. This is called **normal mapping**.

What artifacts in the images would reveal that bump (or normal) mapping is fake?

Displacement vs. bump mapping

Input texture

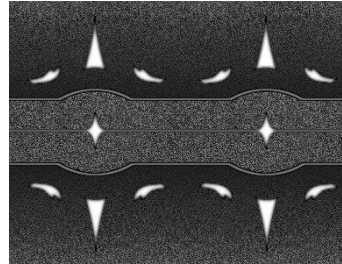

Rendered as displacement map over a rectangular surface

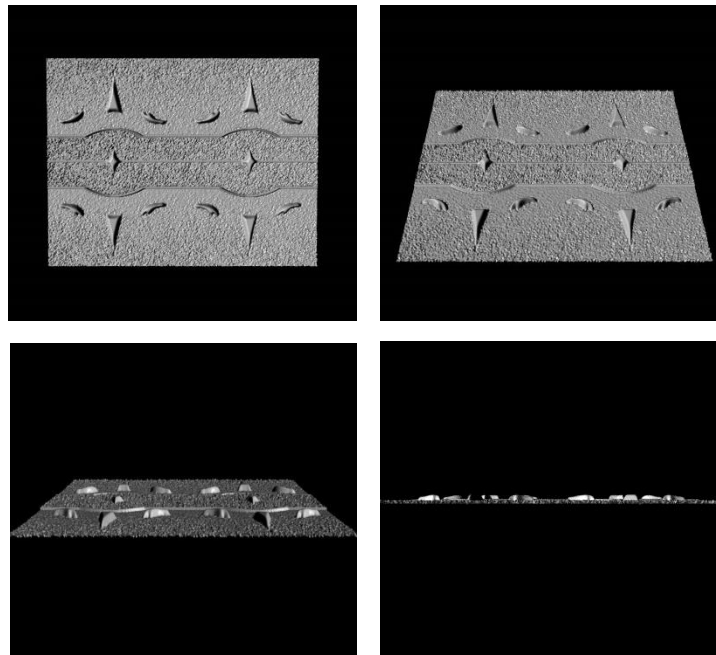

Displacement vs. bump mapping (cont'd)



Original rendering

Rendering with bump map
wrapped around a cylinder

Bump map and rendering by Wyvern Aldinger

Solid textures

Q: What kinds of artifacts might you see from using a marble veneer instead of real marble?

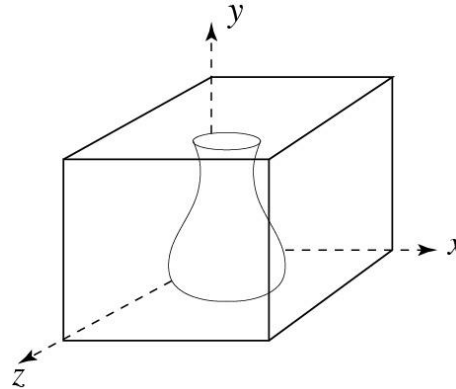

One solution is to use **solid textures**:

- ◆ Use model-space coordinates to index into a 3D texture
- ◆ Like “carving” the object from the material

One difficulty of solid texturing is coming up with the textures.

Solid textures (cont'd)

Here's an example for a vase cut from a solid marble texture:



Solid marble texture by Ken Perlin, (Foley, IV-21)

Solid textures (cont'd)

$\text{in}(x, y, z) = \text{stripes}(x)$

$\text{shift}(x, y, z) = K \cdot \text{noise}(x, y, z)$

$\text{out}(x, y, z) = \text{stripes}(x + \text{shift}(x, y, z))$

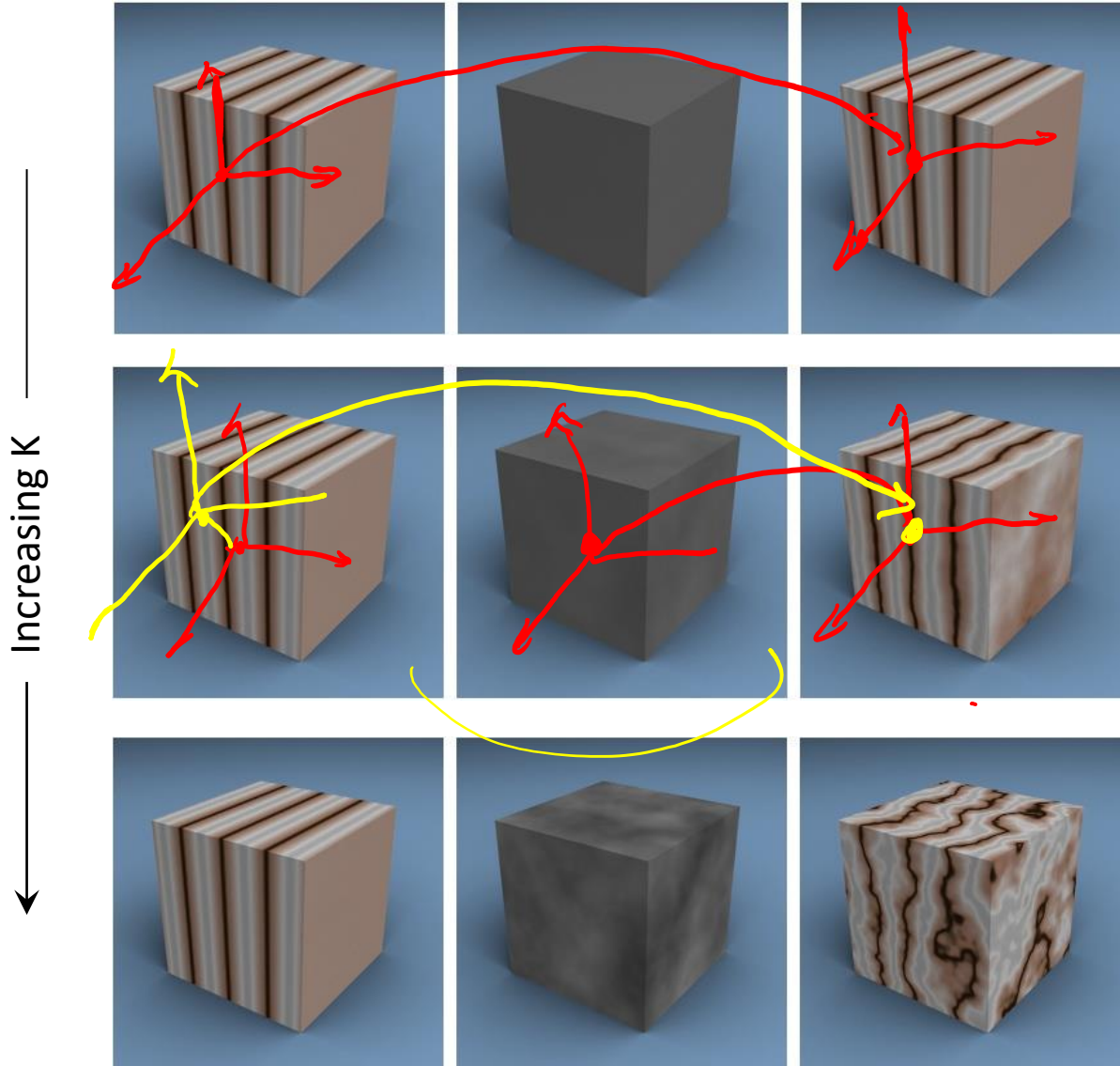

Environment mapping

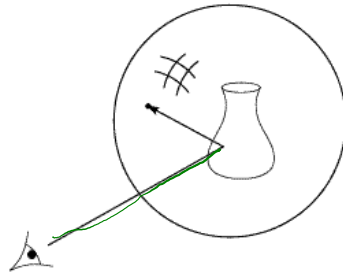

In **environment mapping** (also known as **reflection mapping**), a texture is used to model an object's environment:

- ◆ Rays are bounced off objects into environment
- ◆ Color of the environment used to determine color of the illumination
- ◆ Environment mapping works well when there is just a single object – or in conjunction with ray tracing

This can be readily implemented (without interreflection) in graphics hardware using a fragment shader, where the texture is stored in a “cube map” instead of a sphere.

With a ray tracer, the concept is easily extended to handle refraction as well as reflection (and interreflection).

Summary

What to take home from this lecture:

1. The meaning of the boldfaced terms.
2. Familiarity with the various kinds of texture mapping, including their strengths and limitations.