

CSE 451: Operating Systems Winter 2015

Module 3 Operating System Components and Structure

Mark Zbikowski
mzbik@cs.washington.edu
Allen Center 476

© 2013 Gribble, Lazowska, Levy, Zahorjan

1

OS structure

- The OS sits between application programs and the hardware
 - it mediates access and abstracts away ugliness
 - programs request services via traps or exceptions
 - devices request attention via interrupts

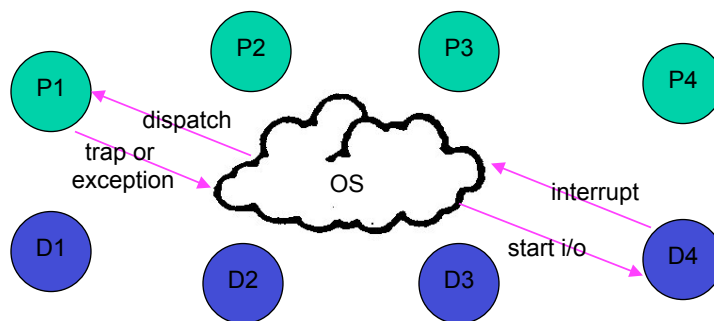

© 2013 Gribble, Lazowska, Levy, Zahorjan

2

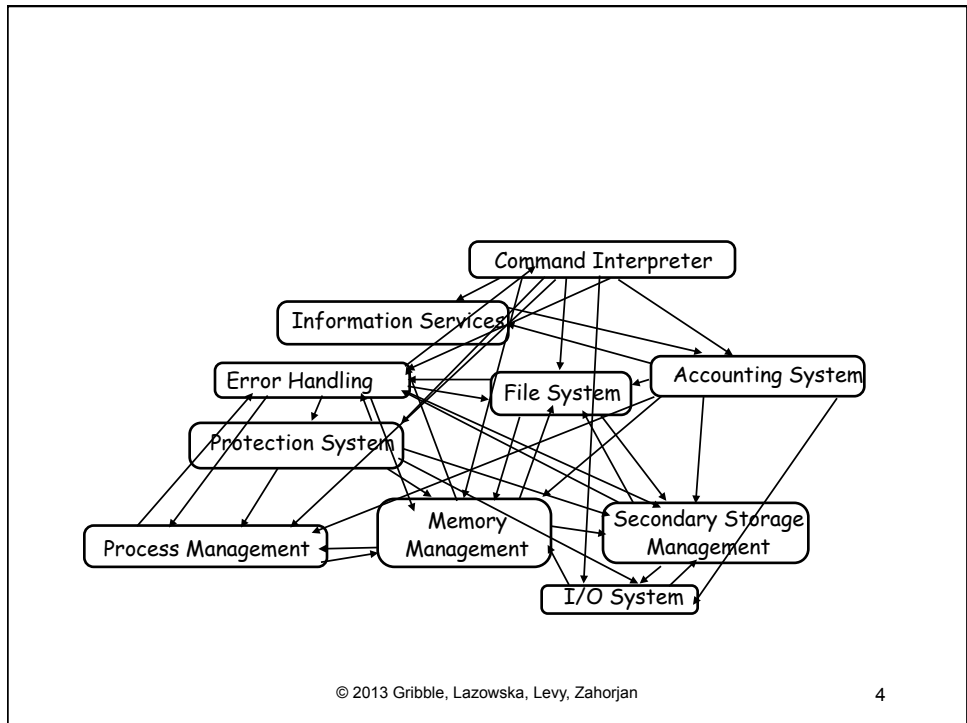
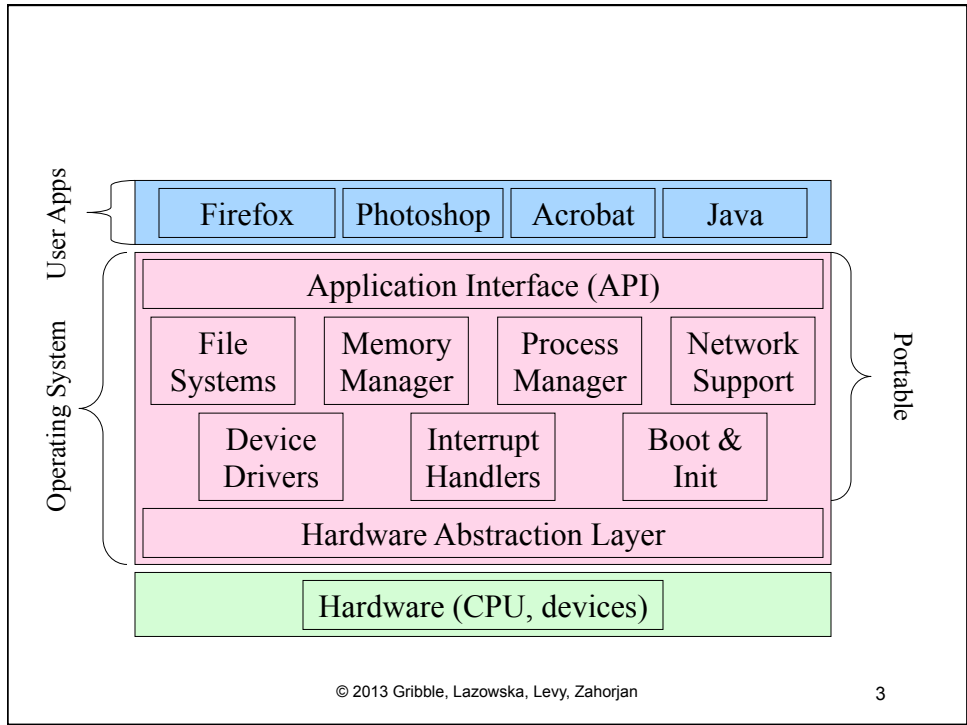

Major OS components

- processes/threads
- memory
- I/O
- secondary storage
- file systems
- protection
- shells (command interpreter, or OS UI)
- GUI
- networking

Process management

- An OS executes many kinds of activities:
 - users' programs
 - batch jobs or scripts
 - system programs
 - print spoolers, name servers, file servers, network daemons, ...
- Each of these activities is encapsulated in a **process**
 - a process includes the execution **context**
 - PC, registers, VM, OS resources (e.g., open files), etc...
 - plus the program itself (code and data)
 - the OS's process module manages these processes
 - creation, destruction, scheduling, ...

Important: Processes vs. Threads

- Soon, we will separate the “thread of control” aspect of a process (program counter, call stack) from its other aspects (address space, open files, owner, etc.). And we will allow each {process / address space} to have multiple threads of control.
- But for now – for simplicity and for historical reasons – consider each {process / address space} to have a single thread of control.

© 2013 Gribble, Lazowska, Levy, Zahorjan

7

Program/processor/process

- Note that a program is totally passive
 - just bytes on a disk that encode instructions to be run
- A process is an instance of a program being executed by a (real or virtual) processor
 - at any instant, there may be many processes running copies of the same program (e.g., an editor); each process is separate and (usually) independent
 - Linux: `ps -auwx` to list all processes

process A

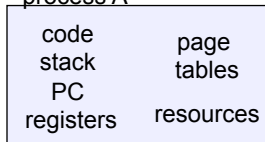

process B

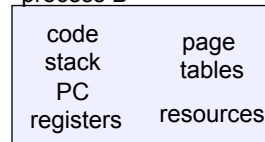

© 2013 Gribble, Lazowska, Levy, Zahorjan

8

States of a user process

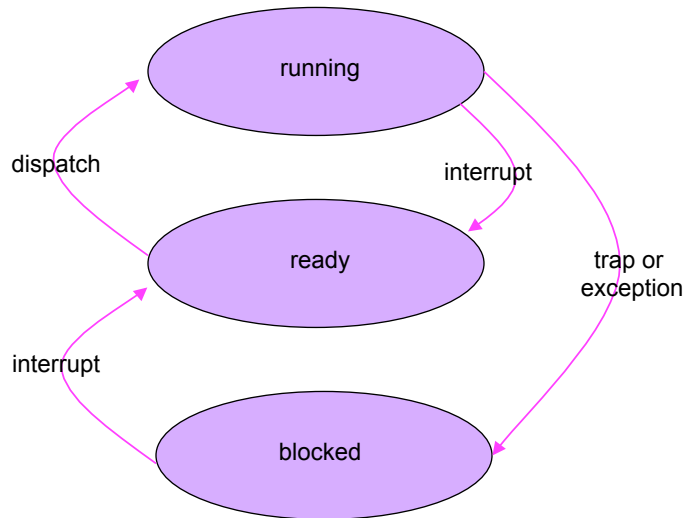

© 2013 Gribble, Lazowska, Levy, Zahorjan

9

Process operations

- The OS provides the following kinds operations on processes (i.e., the process abstraction interface):
 - create a process
 - delete a process
 - suspend a process
 - resume a process
 - clone a process
 - inter-process communication
 - inter-process synchronization
 - create/delete a child process (subprocess)

© 2013 Gribble, Lazowska, Levy, Zahorjan

10

Memory management

- The primary memory is the directly accessed storage for the CPU
 - programs must be resident in memory to execute
 - memory access is fast
 - but memory doesn't survive power failures
- OS must:
 - allocate memory space for programs
 - deallocate space when needed by rest of system
 - maintain mappings from physical to virtual memory
 - through **page tables**
 - decide how much memory to allocate to each process
 - a policy decision
 - decide when to remove a process from memory
 - also policy

© 2013 Gribble, Lazowska, Levy, Zahorjan

11

I/O

- A big chunk of the OS kernel deals with I/O
 - hundreds of thousands of lines in Windows, Unix, etc.
- The OS provides a standard interface between programs (user or system) and devices
 - file system (disk), sockets (network), frame buffer (video)
- **Device drivers** are the routines that interact with specific device types
 - **encapsulates** device-specific knowledge
 - e.g., how to initialize a device, how to request I/O, how to handle interrupts or errors
 - examples: SCSI device drivers, Ethernet card drivers, video card drivers, sound card drivers, ...
- Note: Windows has ~35,000 device drivers!

© 2013 Gribble, Lazowska, Levy, Zahorjan

12

Secondary storage

- Secondary storage (disk, FLASH, tape) is persistent memory
 - often magnetic media, survives power failures (hopefully)
- Routines that interact with disks are typically at a very low level in the OS
 - used by many components (file system, VM, ...)
 - handle scheduling of disk operations, head movement, error handling, and often management of space on disks
- Usually independent of file system
 - although there may be cooperation
 - file system knowledge of device details can help optimize performance
 - e.g., place related files close together on disk

© 2013 Gribble, Lazowska, Levy, Zahorjan

13

File systems

- Secondary storage devices are crude and awkward
 - e.g., “write a 4096 byte block to sector 12”
- File system: a convenient abstraction
 - defines logical objects like **files** and **directories**
 - hides details about where on disk files live
 - as well as operations on objects like read and write
 - read/write byte ranges instead of blocks
- A **file** is the basic unit of long-term storage
 - file = named collection of persistent information
- A **directory** is just a special kind of file
 - directory = named file that contains names of other files and metadata about those files (e.g., file size)
- Note: Sequential byte stream is only one possibility!

© 2013 Gribble, Lazowska, Levy, Zahorjan

14

File system operations

- The file system interface defines standard operations:
 - file (or directory) creation and deletion
 - manipulation of files and directories (read, write, extend, rename, protect)
 - copy
 - lock
- File systems also provide higher level services
 - accounting and quotas
 - backup (must be incremental and online!)
 - (sometimes) indexing or search
 - (sometimes) file versioning

Protection

- Protection is a general mechanism used throughout the OS
 - all resources needed to be protected
 - memory
 - processes
 - files
 - devices
 - CPU time
 - ...
 - protection mechanisms help to detect and contain unintentional errors, as well as preventing malicious destruction

Command interpreter (shell)

- A particular program that handles the interpretation of users' commands and helps to manage processes
 - user input may be from keyboard (command-line interface), from script files, or from the mouse (GUIs)
 - allows users to launch and control new programs
- On some systems, command interpreter may be a standard part of the OS (e.g., MS DOS, Apple II)
- On others, it's just non-privileged code that provides an interface to the user
 - e.g., bash/csh/tcsh/zsh on UNIX
- On others, there may be no command language
 - e.g., MacOS

© 2013 Gribble, Lazowska, Levy, Zahorjan

17

OS structure

- It's not always clear how to stitch OS modules together:

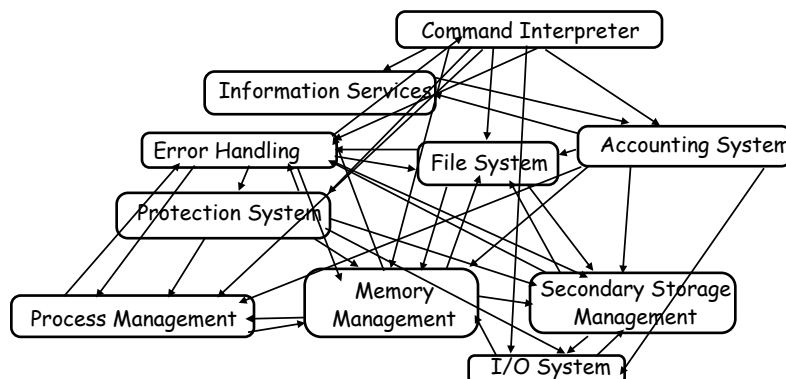

© 2013 Gribble, Lazowska, Levy, Zahorjan

18

OS structure

- An OS consists of all of these components, plus:
 - many other components
 - system programs (privileged and non-privileged)
 - e.g., bootstrap code, the init program, ...
- Major issue:
 - how do we organize all this?
 - what are all of the code modules, and where do they exist?
 - how do they cooperate?
- Massive software engineering and design problem
 - design a large, complex program that:
 - performs well, is reliable, is extensible, is backwards compatible, ...

Windows Longhorn slips again, becomes megaproject

By [John Lettice](#)

Published Tuesday 25th June 2002 10:55 GMT

Vista debut hits a delay

By [Ina Fried](#)

Staff Writer, CNET News.com

Published: March 21, 2006, 3:01 PM PST

Last modified: March 21, 2006, 3:13 PM PST

[TalkBack](#) [E-mail](#) [Print](#) [del.icio.us](#) [Digg this](#)

update Microsoft on Tuesday announced a delay of Windows Vista that will mean PCs with the new operating system won't go on sale until January.

The software maker said it will still wrap up [development of the operating system](#) this year and make it available to volume-licensing customers in November. However, Microsoft said a delay of a few weeks in Vista's schedule meant that some PC makers would be able to launch this year and others would not. As a result, Windows chief Jim Allchin said the company is delaying the broad launch of the product until January.

Early structure: Monolithic

- Traditionally, OS's (like UNIX) were built as a **monolithic** entity:

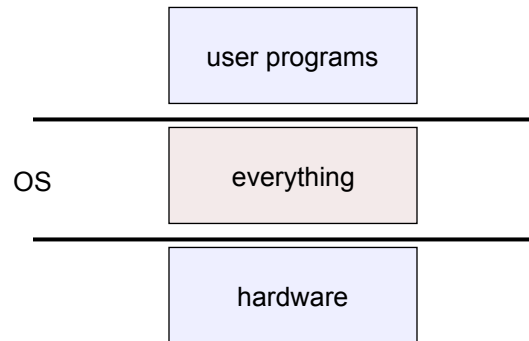

© 2013 Gribble, Lazowska, Levy, Zahorjan

21

Monolithic design

- Major advantage:
 - cost of module interactions is low (procedure call)
- Disadvantages:
 - hard to understand
 - hard to modify
 - unreliable (no isolation between system modules)
 - hard to maintain
- What is the alternative?
 - find a way to organize the OS in order to simplify its design and implementation

© 2013 Gribble, Lazowska, Levy, Zahorjan

22

Layering

- The traditional approach is layering
 - implement OS as a set of layers
 - each layer presents an enhanced 'virtual machine' to the layer above
- The first description of this approach was Dijkstra's THE system
 - Layer 5: **Job Managers**
 - Execute users' programs
 - Layer 4: **Device Managers**
 - Handle devices and provide buffering
 - Layer 3: **Console Manager**
 - Implements virtual consoles
 - Layer 2: **Page Manager**
 - Implements virtual memories for each process
 - Layer 1: **Kernel**
 - Implements a virtual processor for each process
 - Layer 0: **Hardware**
- Each layer can be tested and verified independently

Problems with layering

- Imposes hierarchical structure
 - but real systems are more complex:
 - file system requires VM services (buffers)
 - VM would like to use files for its backing store
 - strict layering isn't flexible enough
- Poor performance
 - each layer crossing has **overhead** associated with it
- Disjunction between model and reality
 - systems modeled as layers, but not really built that way

Hardware Abstraction Layer

- An example of layering in modern operating systems
- Goal: separates hardware-specific routines from the “core” OS
 - Provides portability
 - Improves readability

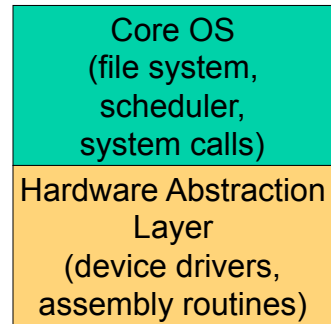

Microkernels

- Introduced in the late 80's, early 90's
 - recent resurgence of popularity
- Goal:
 - minimize what goes in kernel
 - organize rest of OS as user-level processes
- This results in:
 - better reliability (isolation between components)
 - ease of extension and customization
 - poor performance (user/kernel boundary crossings)
- First microkernel system was Hydra (CMU, 1970)
 - Follow-ons: Mach (CMU), Chorus (French UNIX-like OS), OS X (Apple)

Microkernel structure illustrated

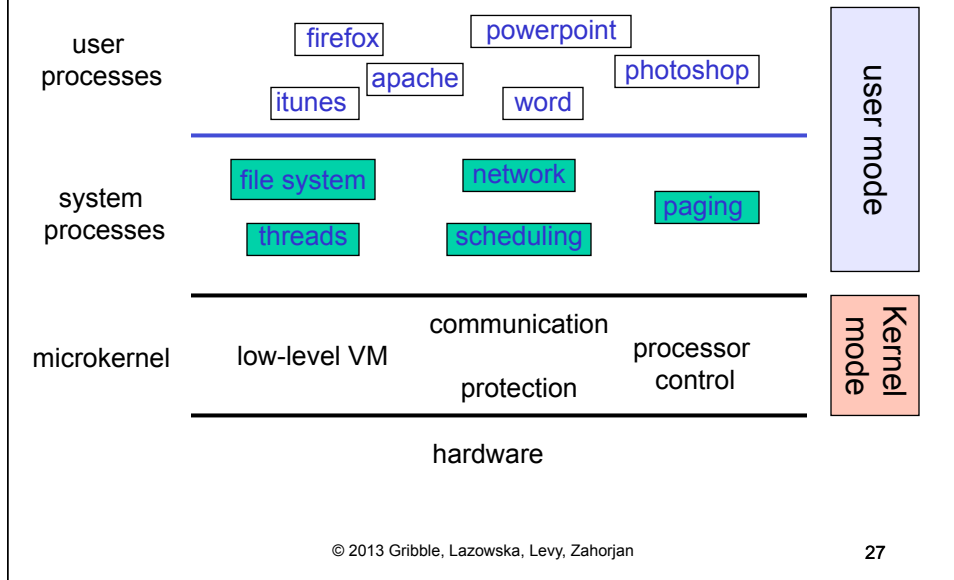

EXAMPLE: WINDOWS

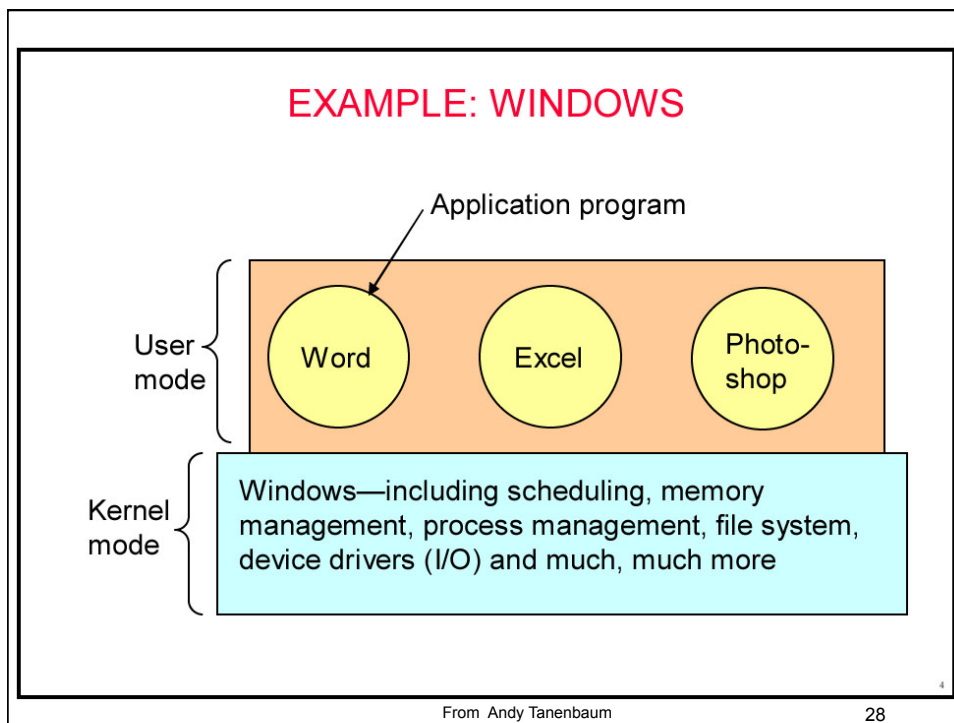

ARCHITECTURE OF MINIX 3

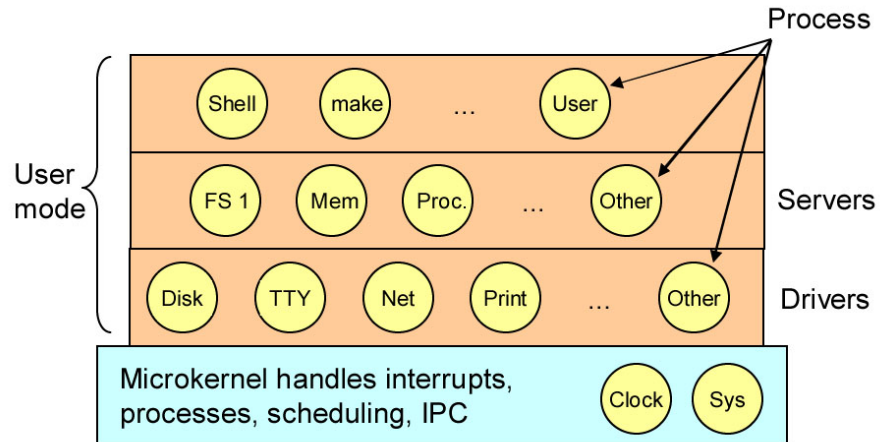

From Andy Tanenbaum

29

Virtual Machine Monitors

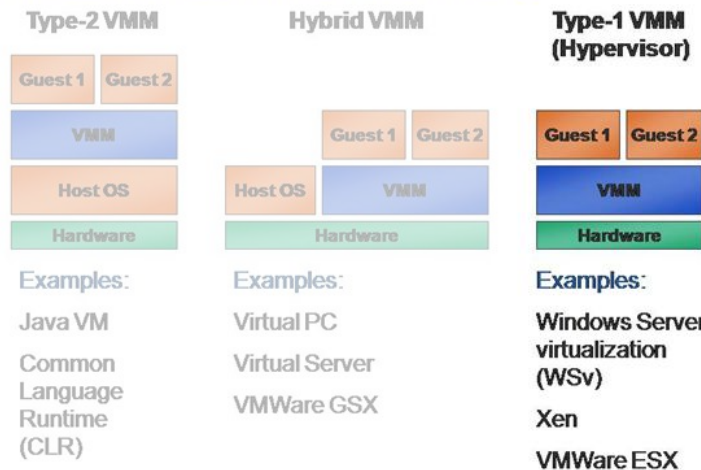

- Transparently implement “hardware” in software
- Voilà, you can boot a “guest OS”

From <http://port25.technet.com/>

30

Summary and Next Module

- **Summary**
 - OS design has been an evolutionary process of trial and error. Probably more error than success
 - Successful OS designs have run the spectrum from monolithic, to layered, to micro kernels, to virtual machine monitors
 - The role and design of an OS are still evolving
 - It is impossible to pick one “correct” way to structure an OS
- **Next module**
 - Processes, one of the most fundamental pieces in an OS
 - What is a process, what does it do, and how does it do it