

LAUNDR

Laundr

Shared laundry made tolerable

PROBLEM

People with shared laundry machines face coordination and scheduling issues with others in their living space, resulting in decreased utilization of laundry resources.

VALUE PROPOSITION

Laundr is a smart laundry system designed to coordinate laundry resources in a shared environment. You can monitor machine availability, your own laundry while it is in the machine, or both!

COMPONENTS

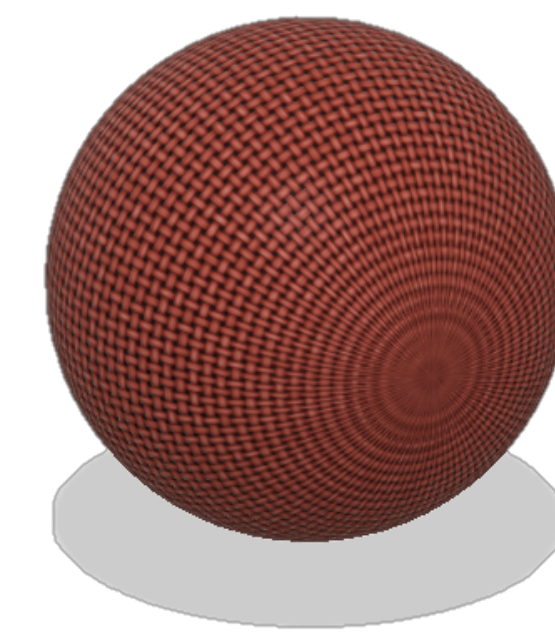

Smart laundry ball

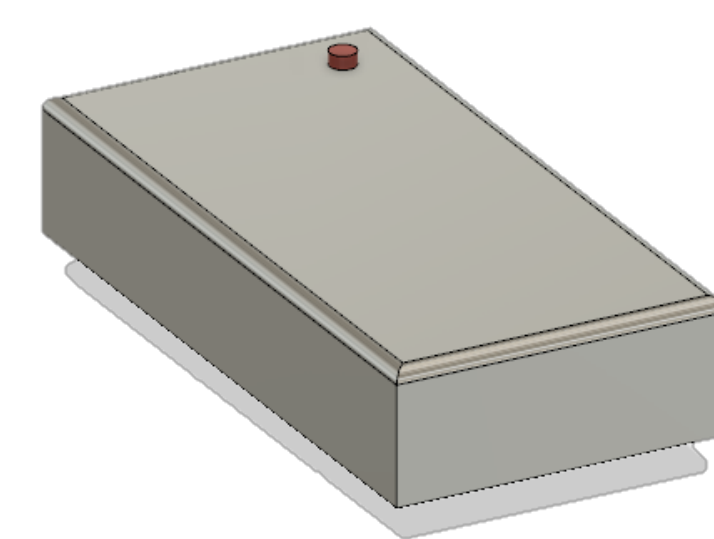

Machine sensor

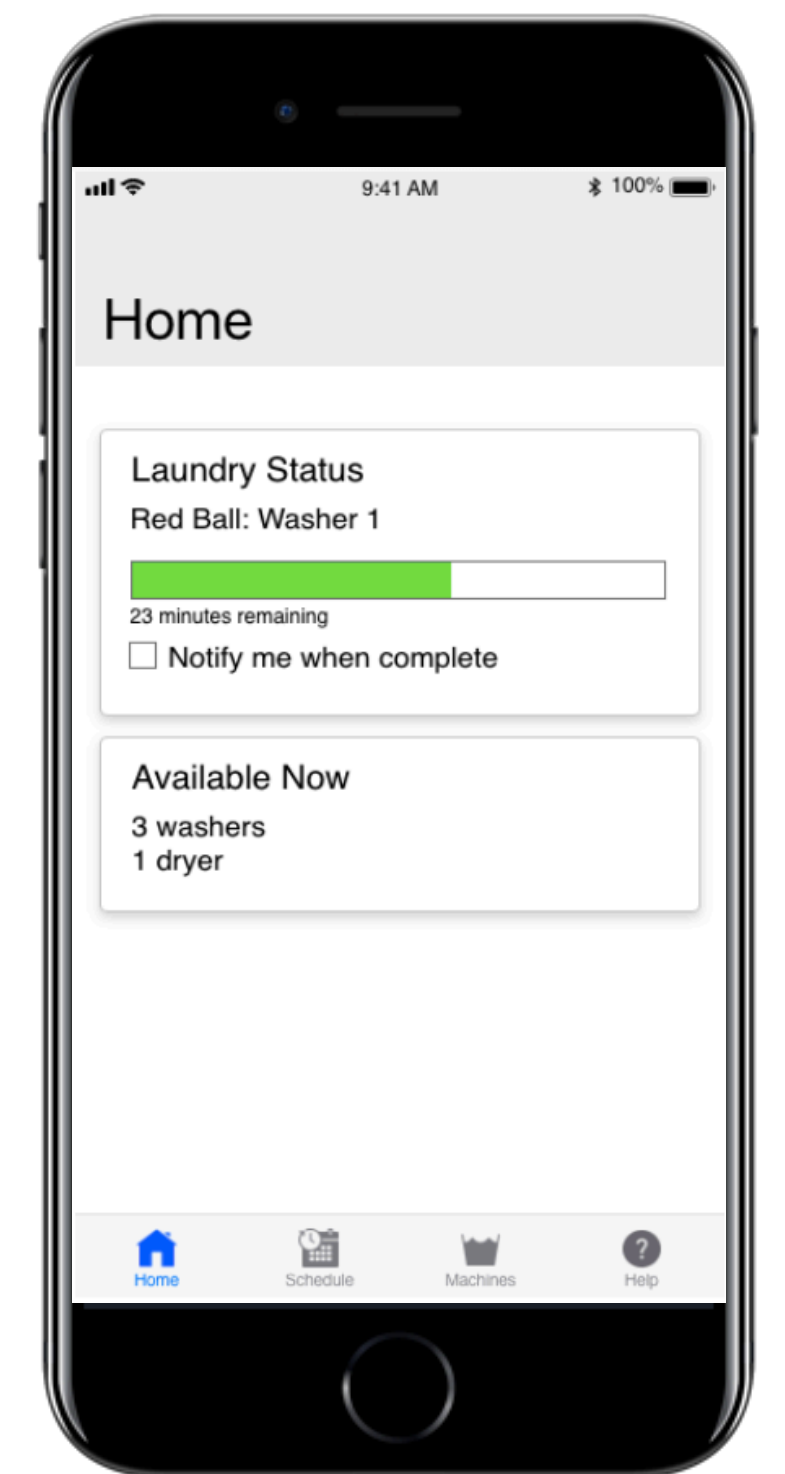

Mobile app

KEY FEATURES

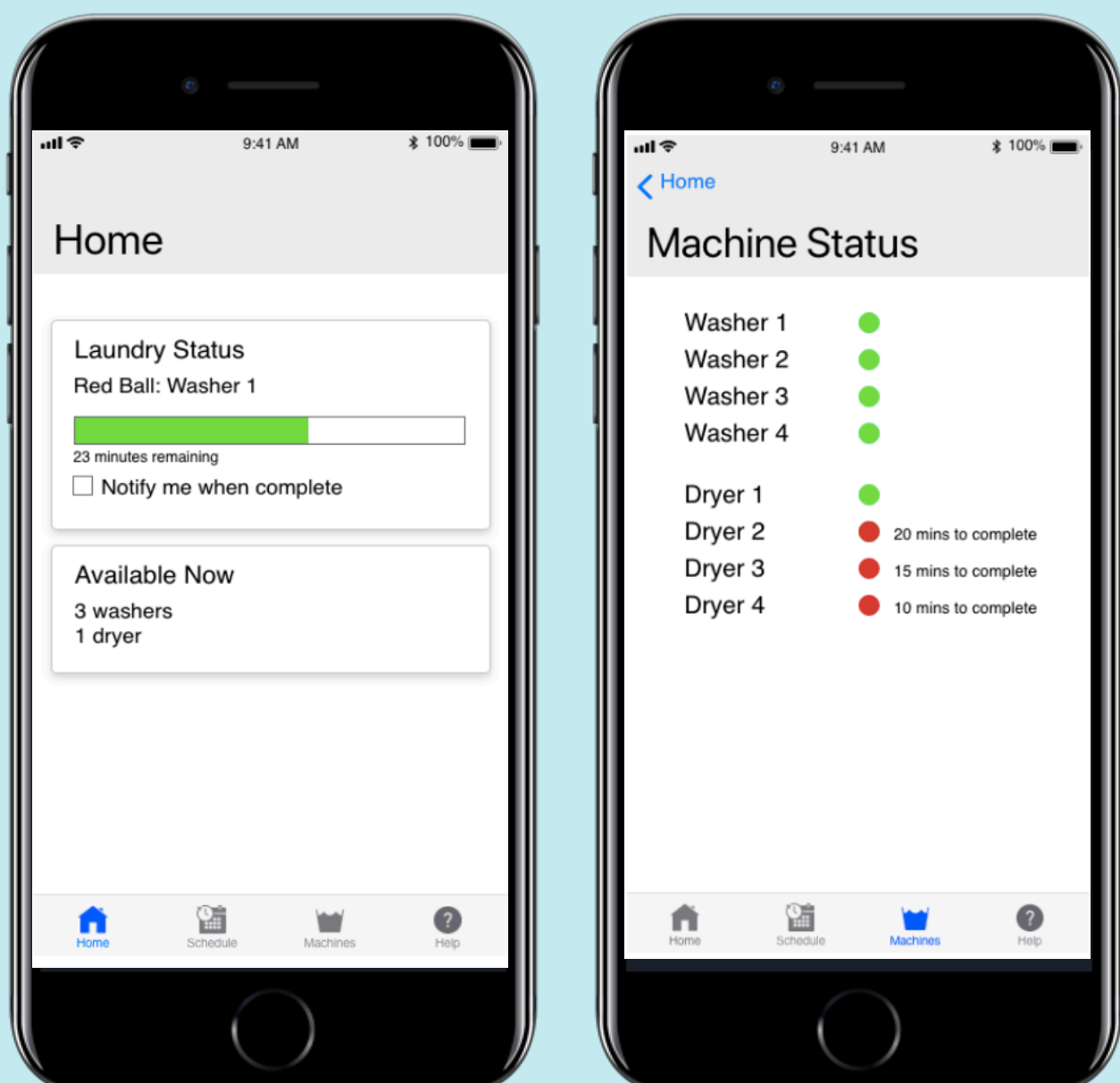

Check your laundry status and machine availability in real time

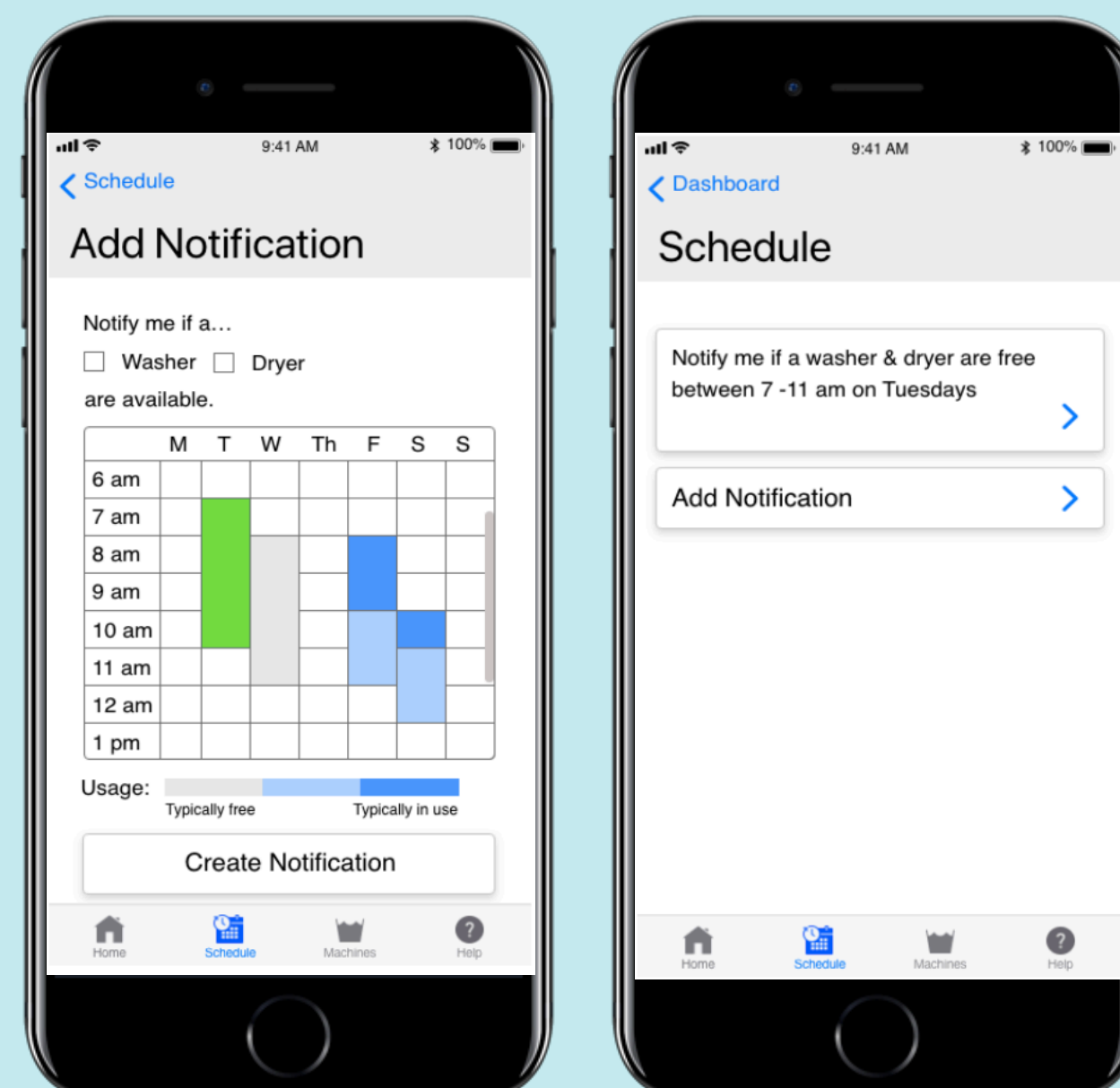

Schedule laundry reminders

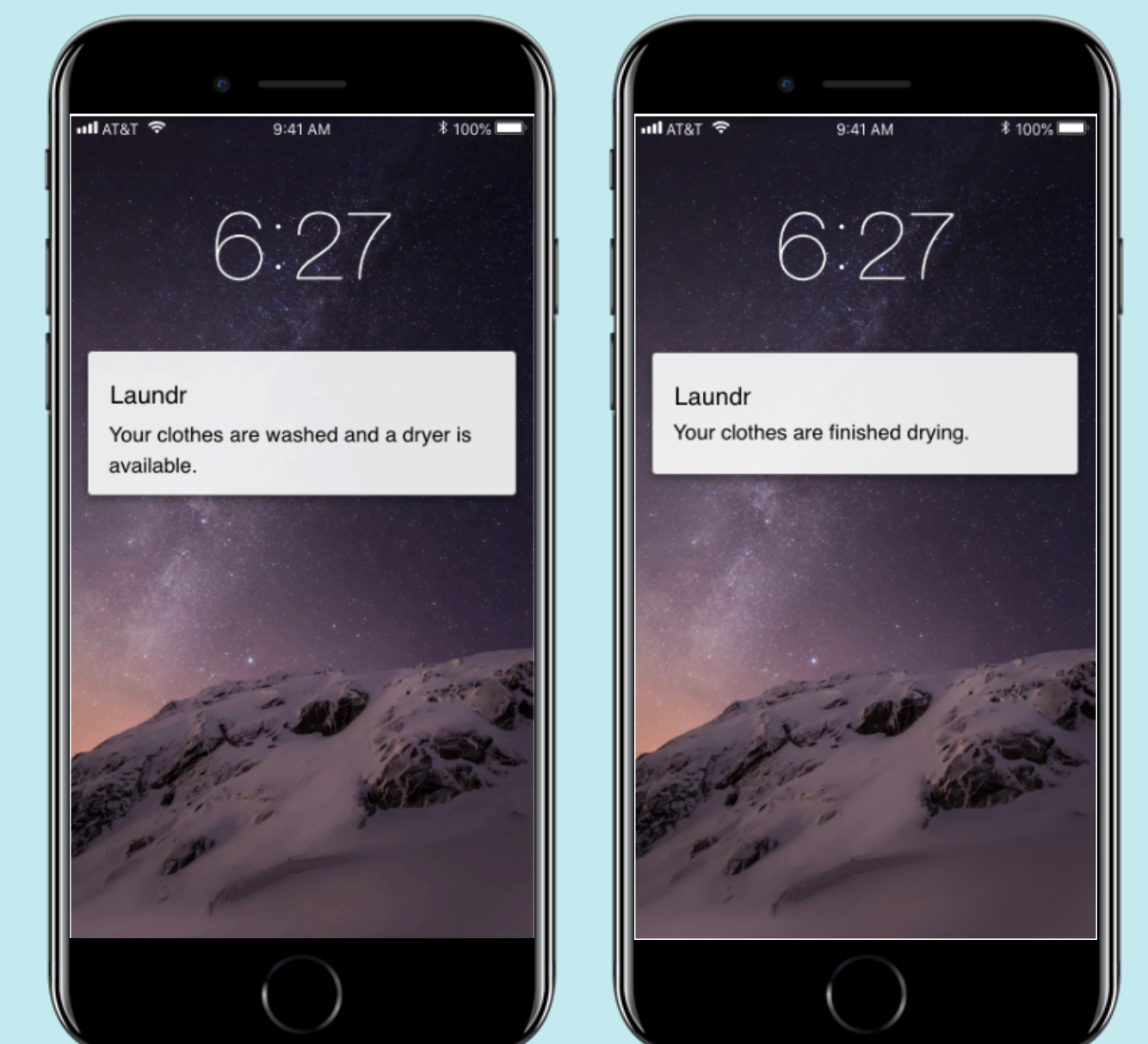

Receive notifications about laundry status and machine availability

DESIGN PROCESS

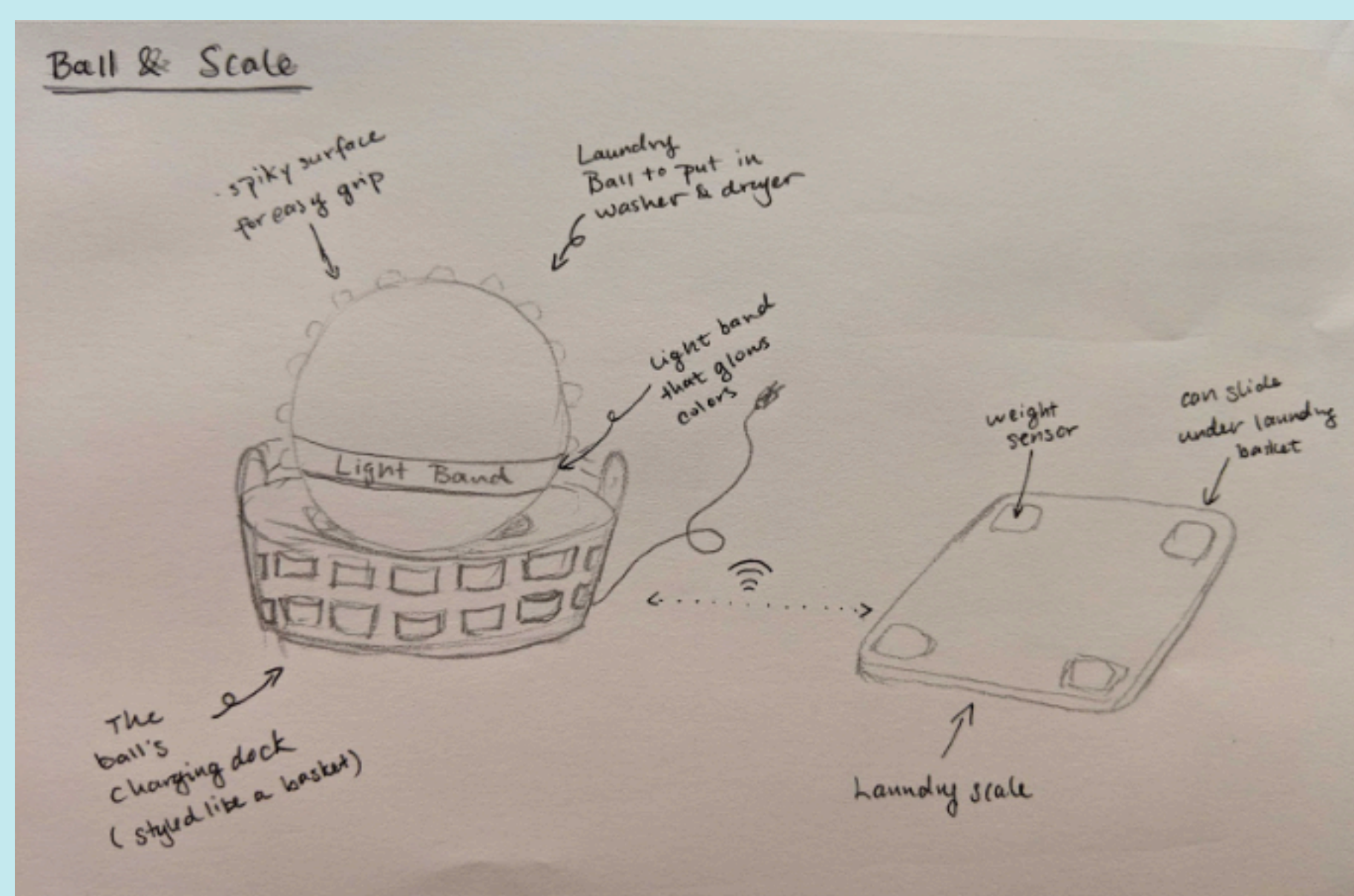

Sketches

We explored our design space and decided on key functionality

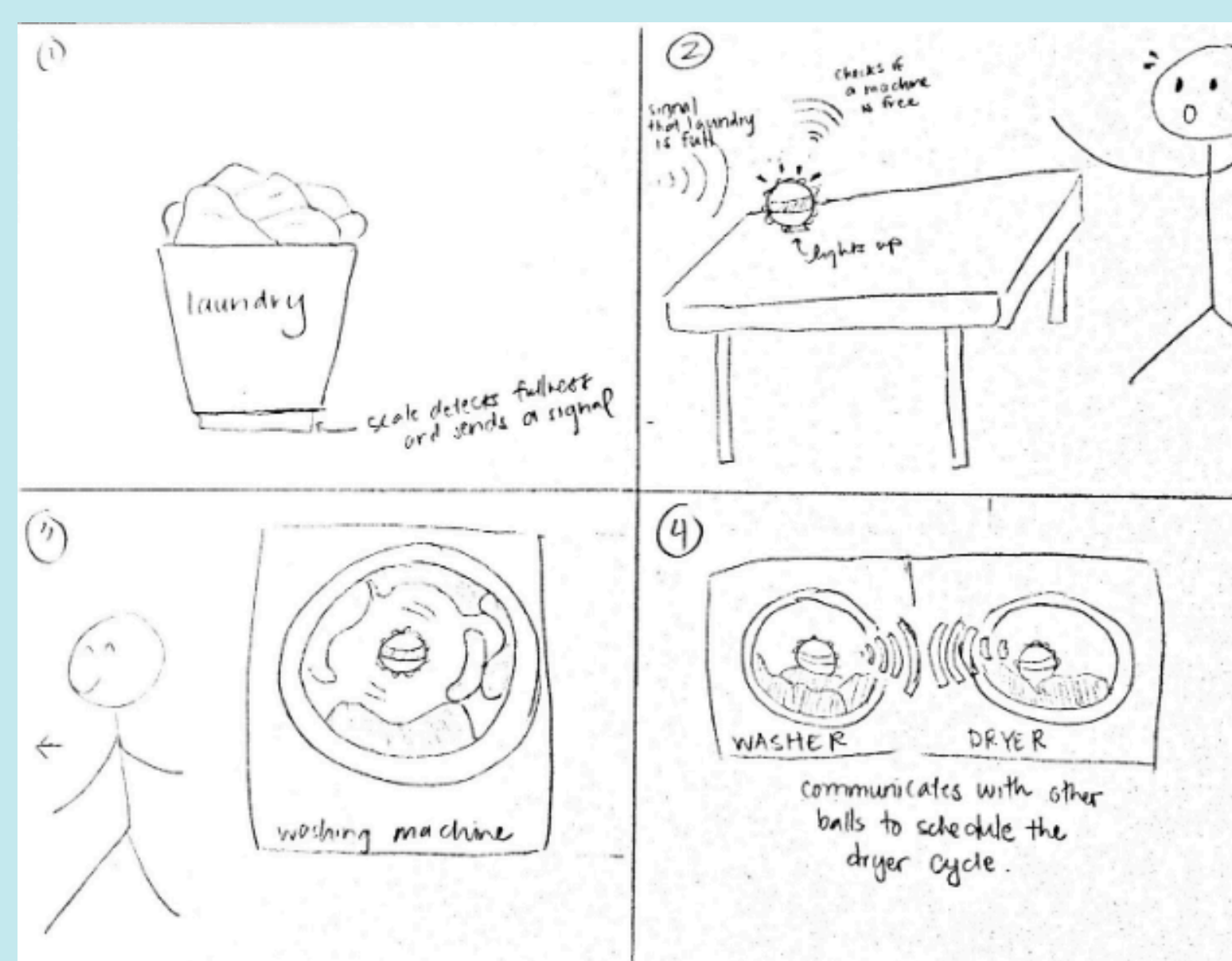

Storyboards

We studied scenarios where Laundr could be useful

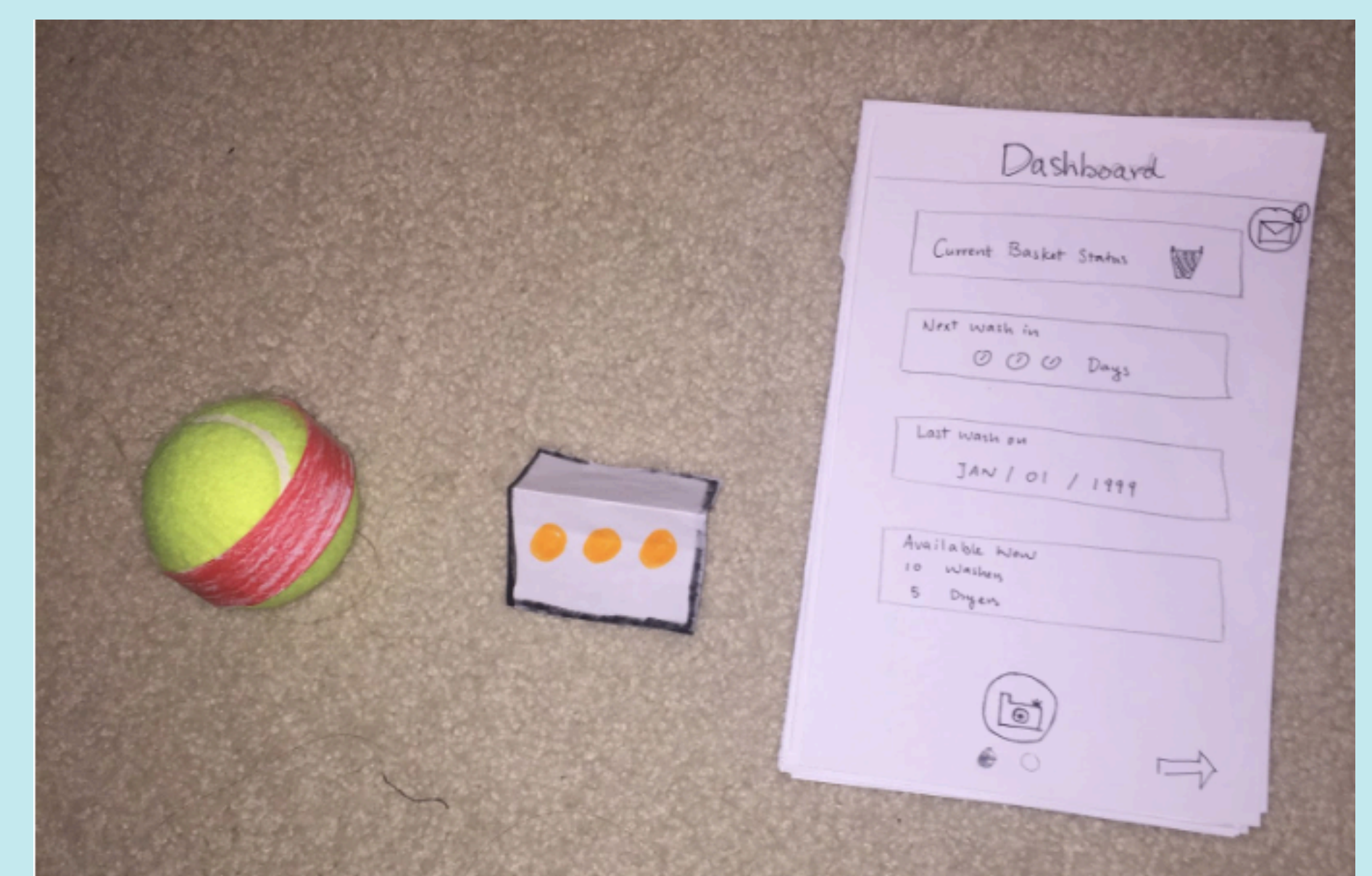

Paper Prototype

We tested our ideas with real users and revised based on their feedback