

CSE 401/M501 – Compilers

Dynamic Languages

Hal Perkins

Fall 2023

Administrivia

- Hw4 due tomorrow night; if you have late days you can use them
- Sections this week: last-minute hw4 Q&A, quarter wrapup, and whatever you and your instructors want to do 😊
- CSE M 501 compiler project due Saturday 11pm
 - Report due Sunday night 11pm
 - No late submissions on either of these (see m501 additions writeup)
- Please finish course evals while they are still available
- Please nominate great TAs for the Bandes award.
 - Both for CSE 401/M501 and for other courses

Final exam

- Tuesday 2:30-4:20 here
- Closed book like midterm, but ok to have two 5x8 hand-written note cards (can re-use midterm card or replace it)
 - Blank cards available end of class today & Friday & sections tomorrow & review session
- Topic list posted on website now
- Review Q&A Monday 4:30, also here
- HW4 sample solutions will be available outside Perkins' office (CSE 548) by late Sun. (will announce on discussion board when ready).
 - Copies also available at the Monday review session.

References

- *An Efficient Implementation of Self, a dynamically-typed object-oriented language based on prototypes*, Chambers, Unger, Lee, OOPSLA 1989
- Earlier versions of this lecture by Vijay Menon, CSE 501, adapted from slides by Kathleen Fisher

Dynamic Typing (reminder)

JavaScript:

```
function foo(a, b) {  
  t1 = a.x;      // runtime field lookup  
  t2 = b.y();   // runtime method lookup  
  t3 = t1 + t2; // runtime dispatch on '+'  
  return t3;  
}
```

Overview

- Self
 - 35(!) year old research language
 - One of earliest JIT compilation systems
 - Pioneered techniques used today
- JavaScript
 - Self with a Java syntax (plus other things...)
 - Lots of interest in making it fast in recent years

Self

- Prototype-based pure object-oriented language
- Designed by Randall Smith (Xerox PARC) and David Ungar (Stanford University)
 - Successor to Smalltalk-80
 - “Self: The power of simplicity” at OOPSLA ‘87
 - Initial implementation done at Stanford; then project shifted to Sun Microsystems Labs
 - Vehicle for implementation research
- Current version available from selflanguage.org

Design Goals

- Occam's Razor: Conceptual economy
 - Everything is an object.
 - Everything done using messages.
 - No classes
 - No variables
- Concreteness
 - Objects should seem “real”
 - GUI to manipulate objects directly

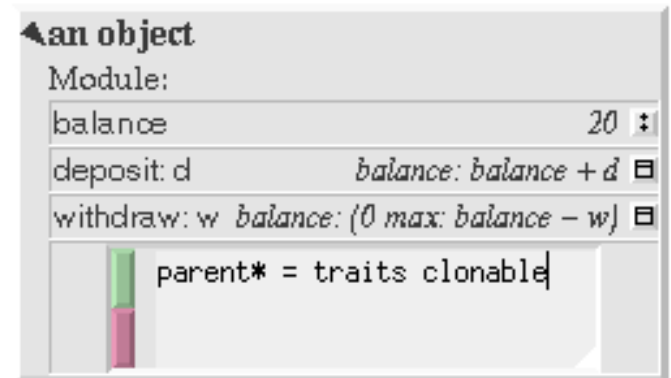

How successful?

- Very well-designed language, but...
- Few users: not a popular success
- However, many research innovations
 - Very simple computational model
 - Enormous advances in compilation techniques
 - Influenced the design of Java compilers
 - JavaScript object model based on Self

Language Overview

- Dynamically typed
- Everything is an object
- All computation via message passing
- Creation and initialization done by copying example (prototype) object
- Operations on objects:
 - send messages
 - add new slots
 - replace old slots
 - remove slots

Objects and Slots

Object consists of named slots.

– Data

- Such slots return contents upon evaluation; so act like variables

– Assignment

- Set the value of associated slot

– Method

- Slot contains Self code

– Parent

- References an object to inherit its slots

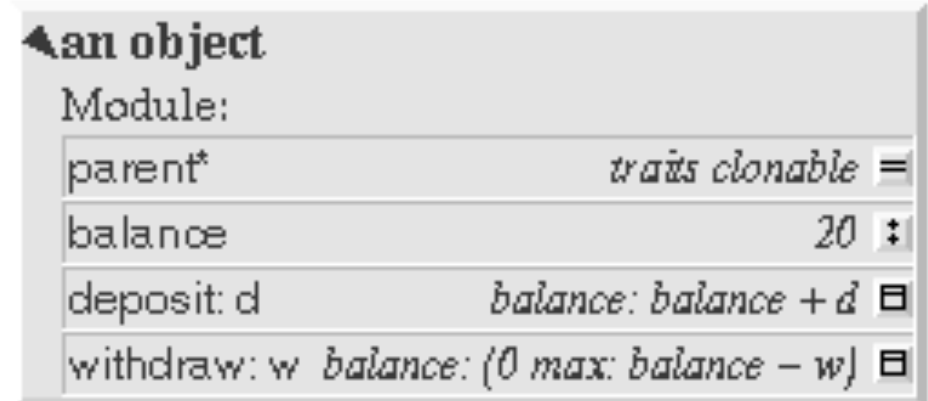

←an object

Module:	
parent*	<i>traits clonable</i> =
balance	20 *
deposit: d	<i>balance: balance + d</i> □
withdraw: w	<i>balance: (0 max: balance - w)</i> □

Messages and Methods

- When a message is sent, search the receiver object for a slot with that name
- If none found, all parents are searched
 - Runtime error if more than one parent has a slot with the same name
- If slot found, its contents are evaluated and returned
 - Runtime error if no slot found

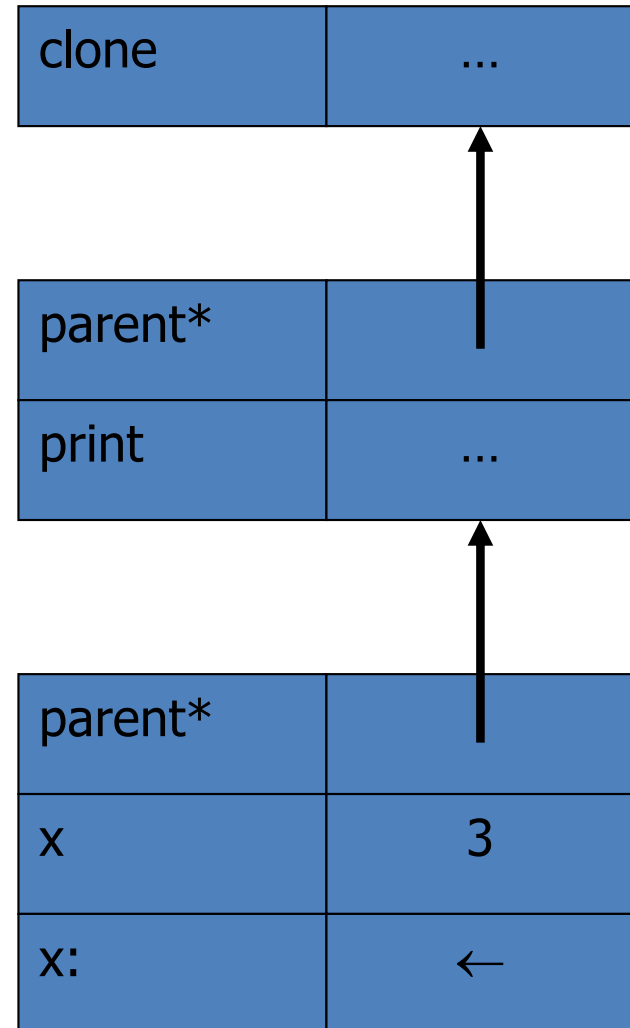

Messages and Methods

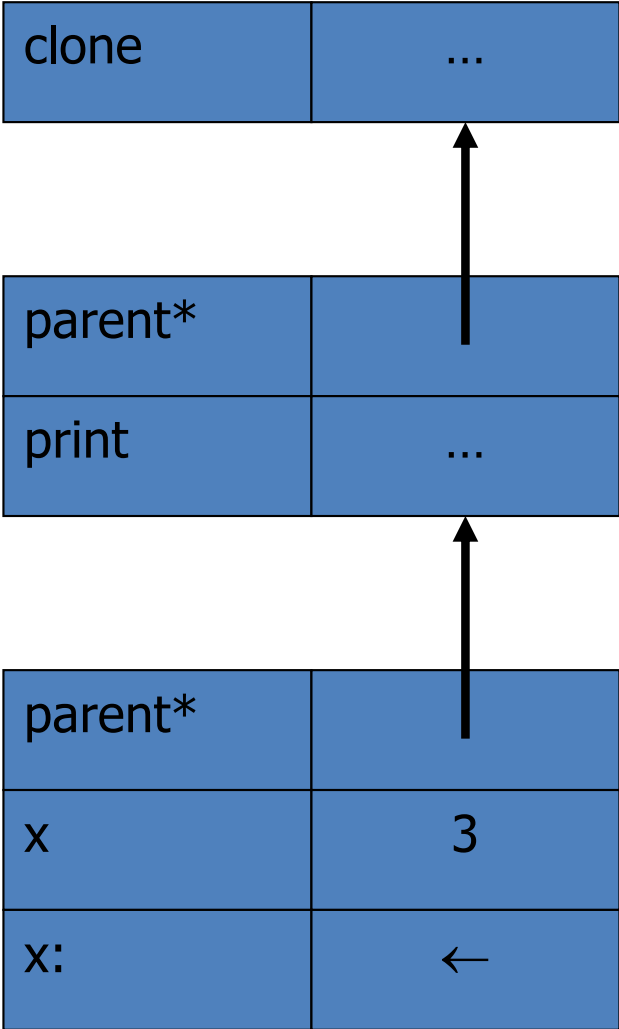
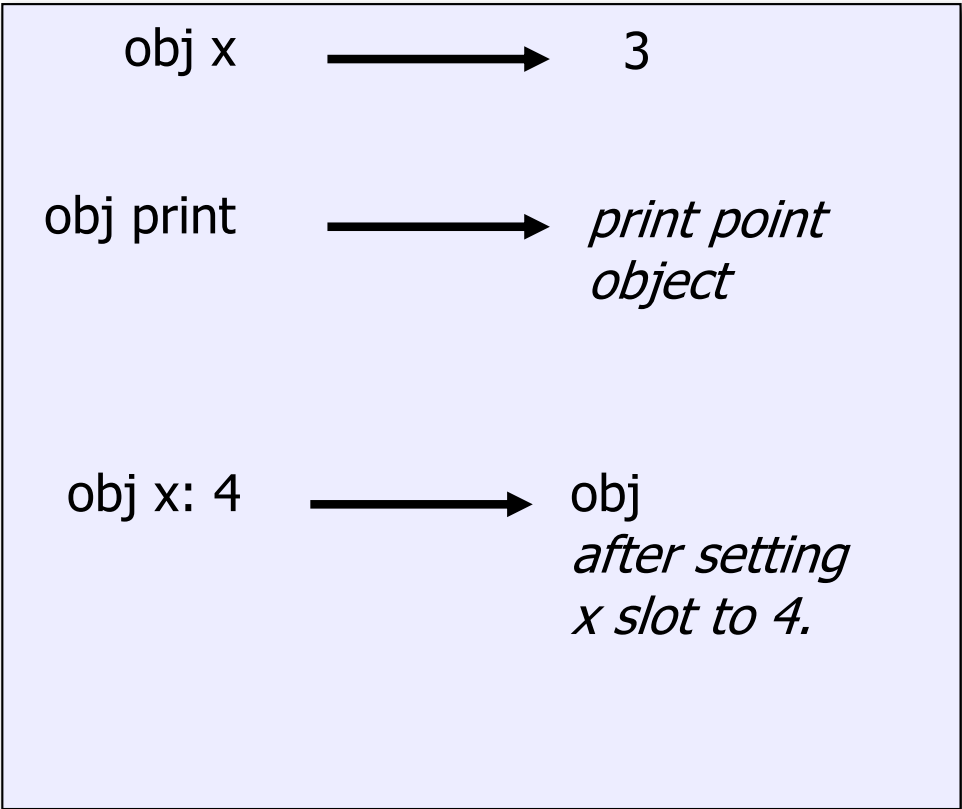

Mixing State and Behavior

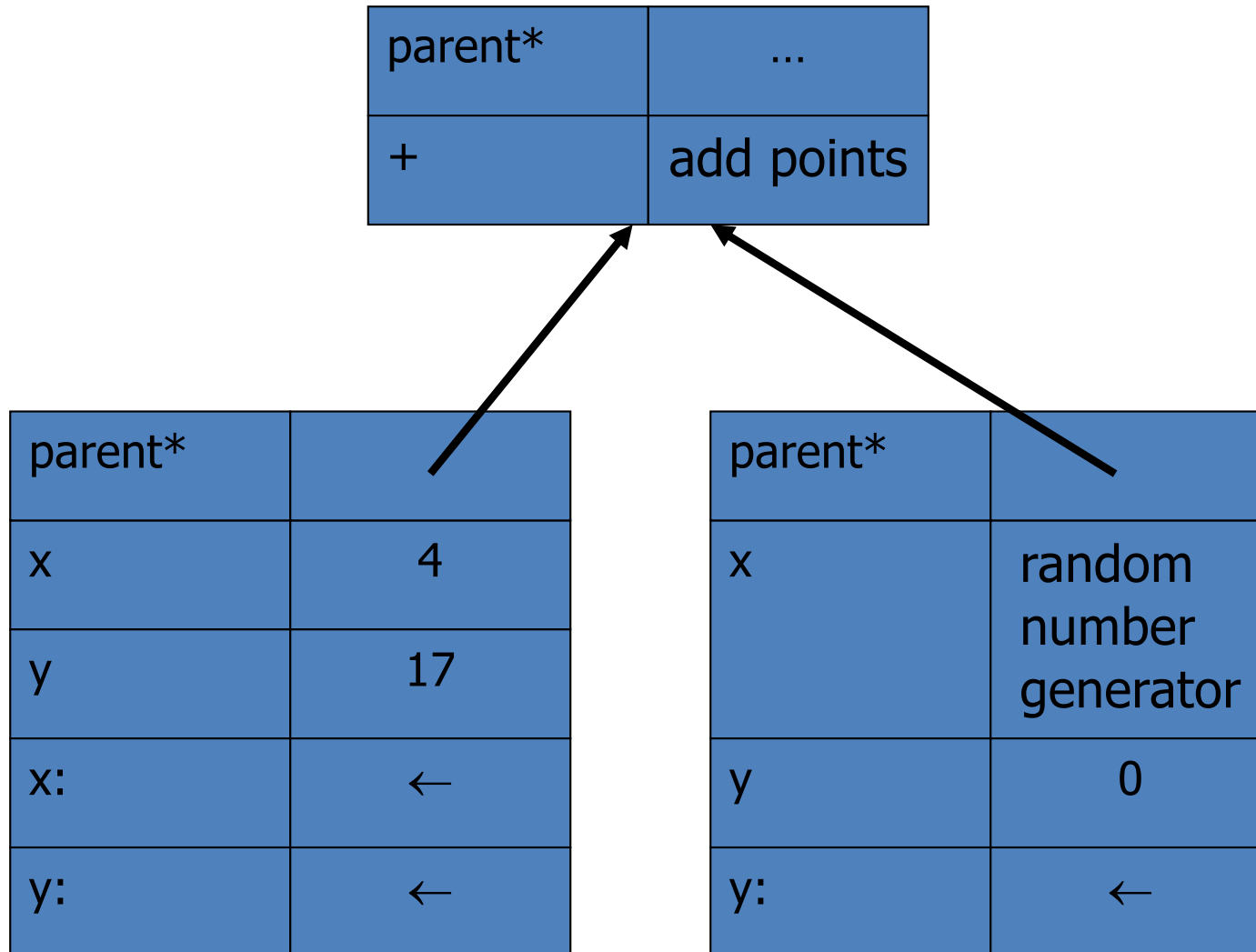

Object Creation

- To create an object, we copy an old one
- We can **add** new methods, **override** existing ones, or even **remove** methods
- These operations also apply to **parent** slots

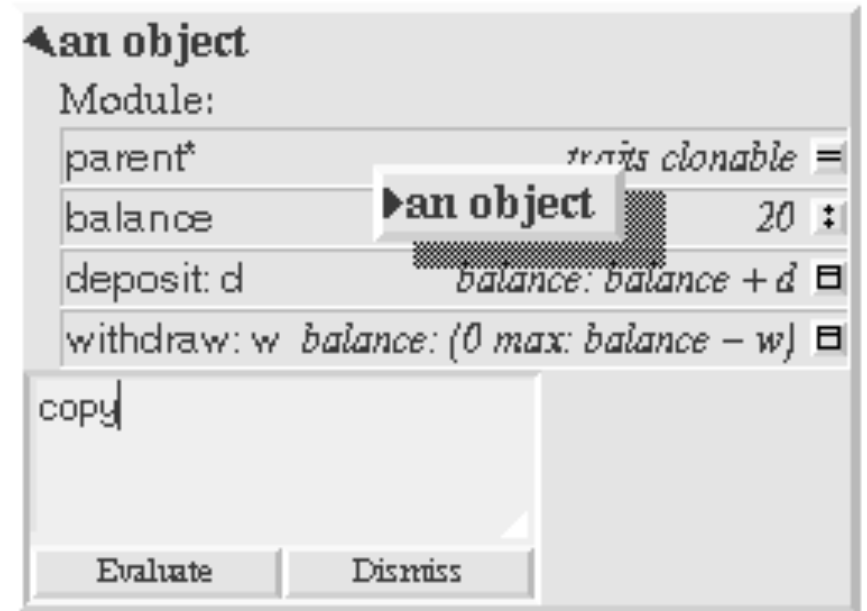

Changing Parent Pointers

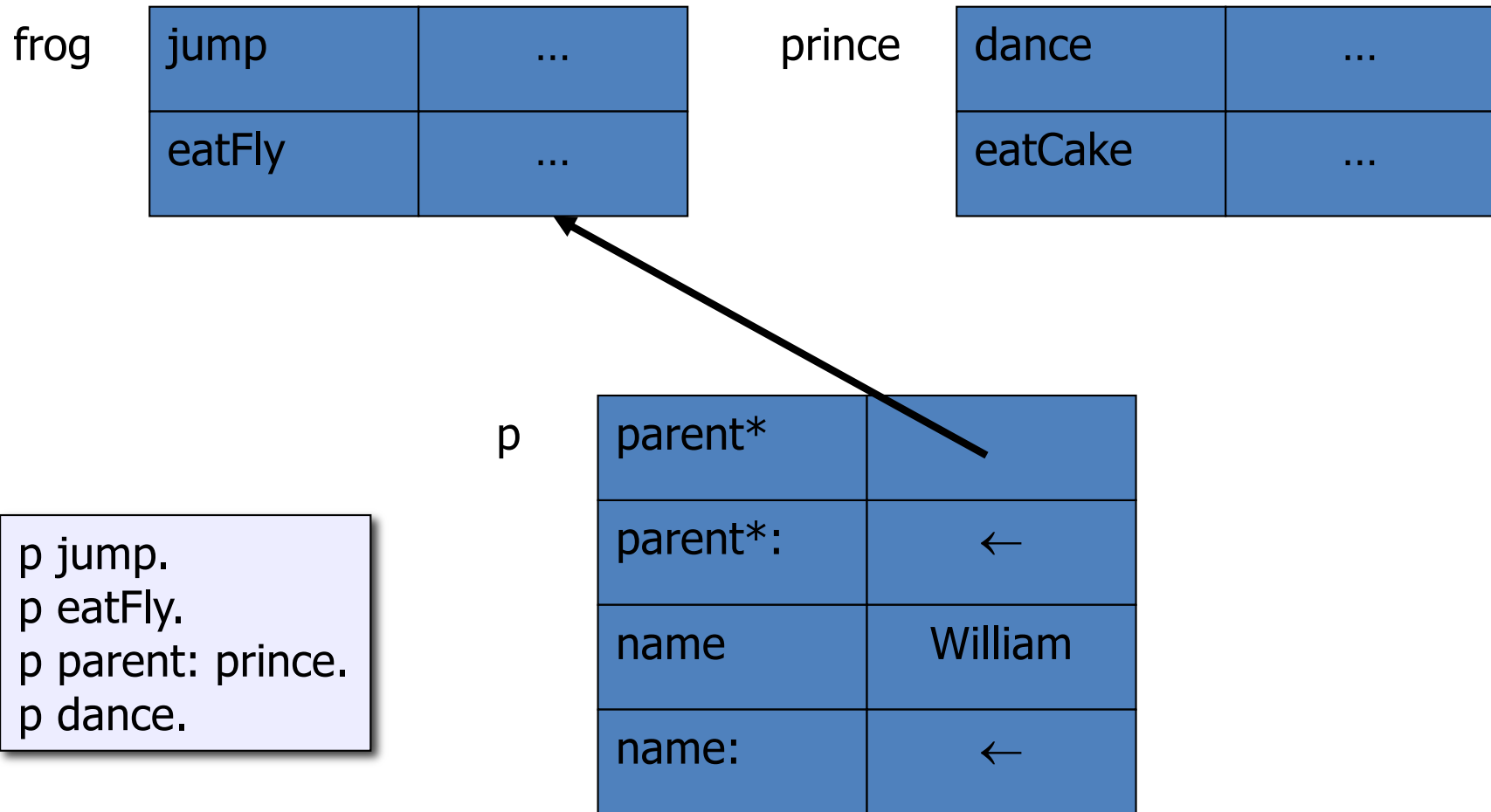

Changing Parent Pointers

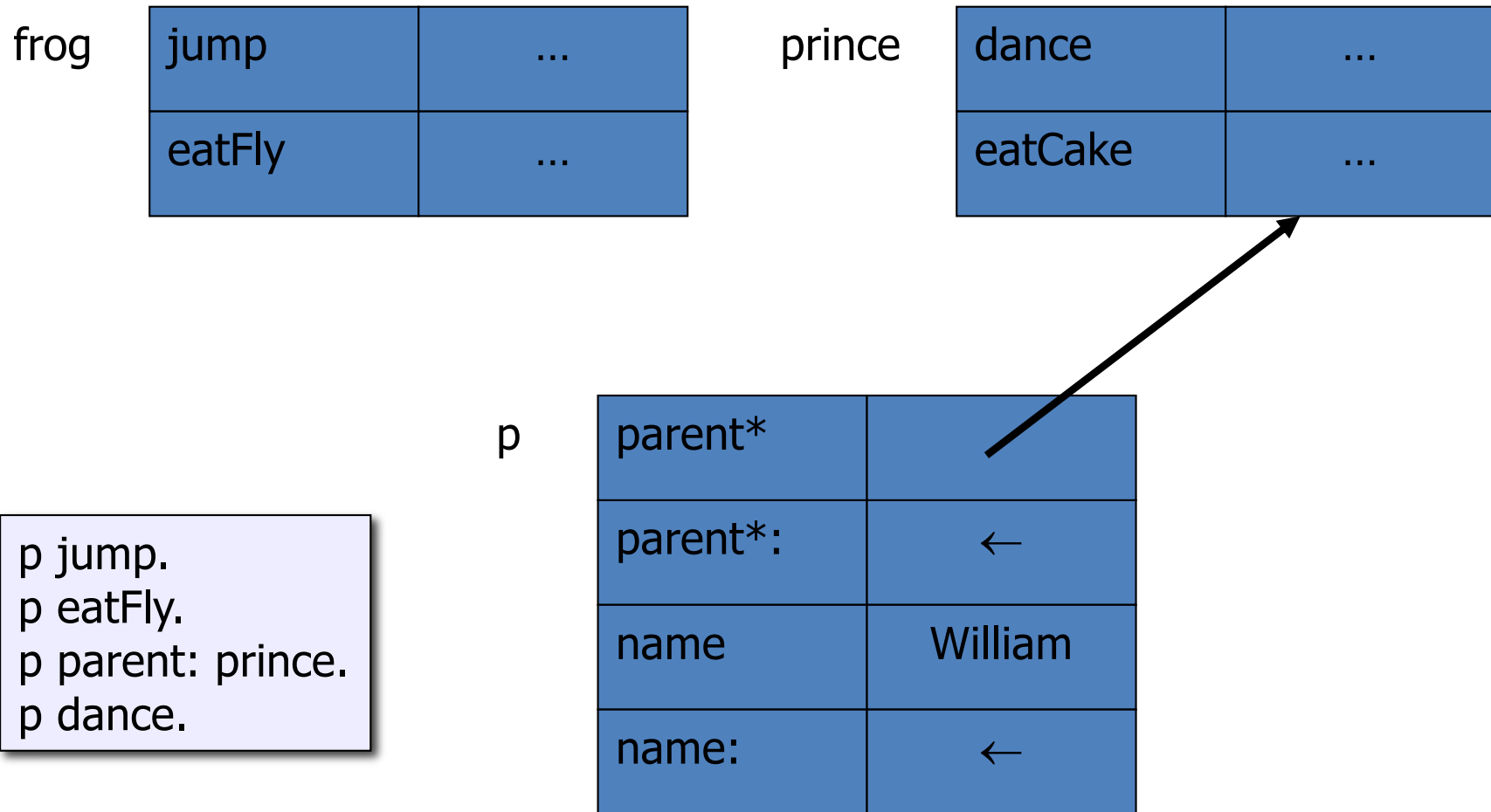

Disadvantages of classes?

- Classes require programmers to understand a more complex model
 - To make a new kind of object, we have to create a new class first
 - To change an object, we have to change the class
 - Infinite meta-class regression (What is the class of a class? Or: Is a class an object, and if not, what is it?)
- **But:** Does Self require programmers to reinvent structure?
 - Common to structure Self programs with *traits*: objects that simply collect behavior for sharing

Contrast with C++ / Java

- C++ / Java
 - Restricts expressiveness to ensure efficient implementation and type safety
 - “message not understood” is not possible
- Self
 - Provides unbreakable high-level model of underlying machine
 - Compiler does fancy optimizations to obtain acceptable performance

Implementation Challenges I

- Many, many slow function calls:
 - Function calls generally somewhat expensive
 - Dynamic dispatch makes message invocation even slower than typical procedure calls
 - OO programs tend to have lots of small methods
 - Everything is a message: even variable access!

“The resulting call density of pure object-oriented programs is staggering, and brings naïve implementations to their knees” [Chambers & Ungar, PLDI 89]

Implementation Challenges II

- No static type system
 - Each reference could point to any object, making it hard to find methods statically
- No class structure to enforce sharing
 - Copies of methods in every object creates lots of space overhead

Optimized Smalltalk-80 is roughly 10 times slower than optimized C

Optimization Strategies

- Avoid per-object space requirements
- Compile, don't interpret
- Avoid method lookup
- Inline methods wherever possible
 - Saves method call overhead
 - Enables further optimizations

Clone Families

(Objects created from same prototype)

Avoid per object data

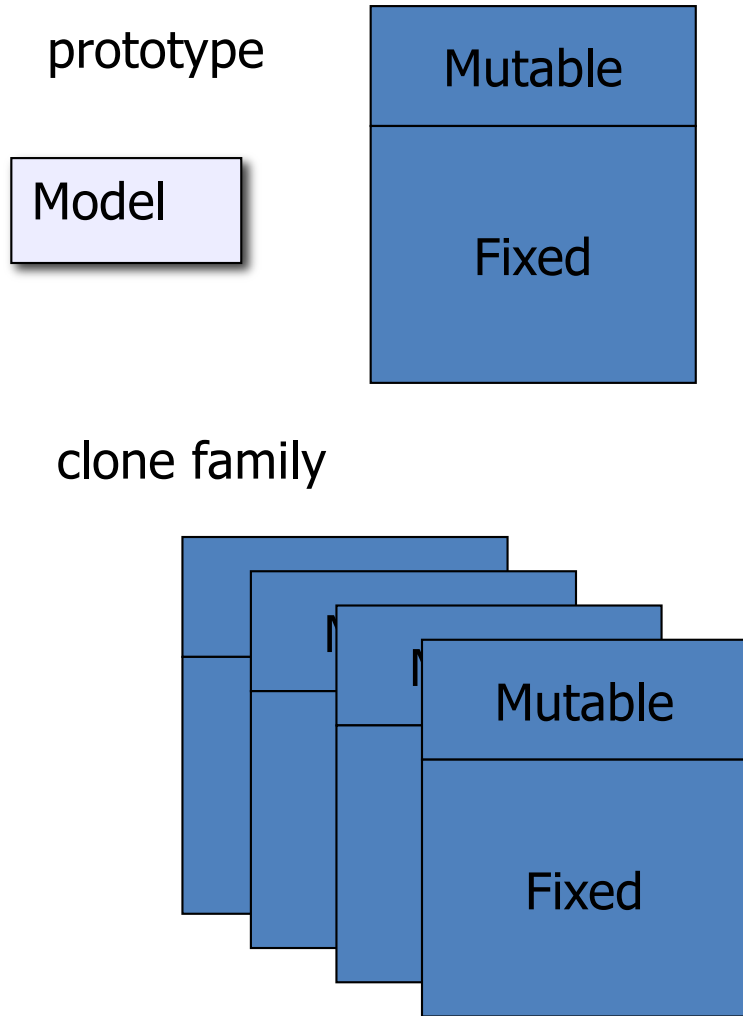

Implementation

Map:

Dynamic Compilation

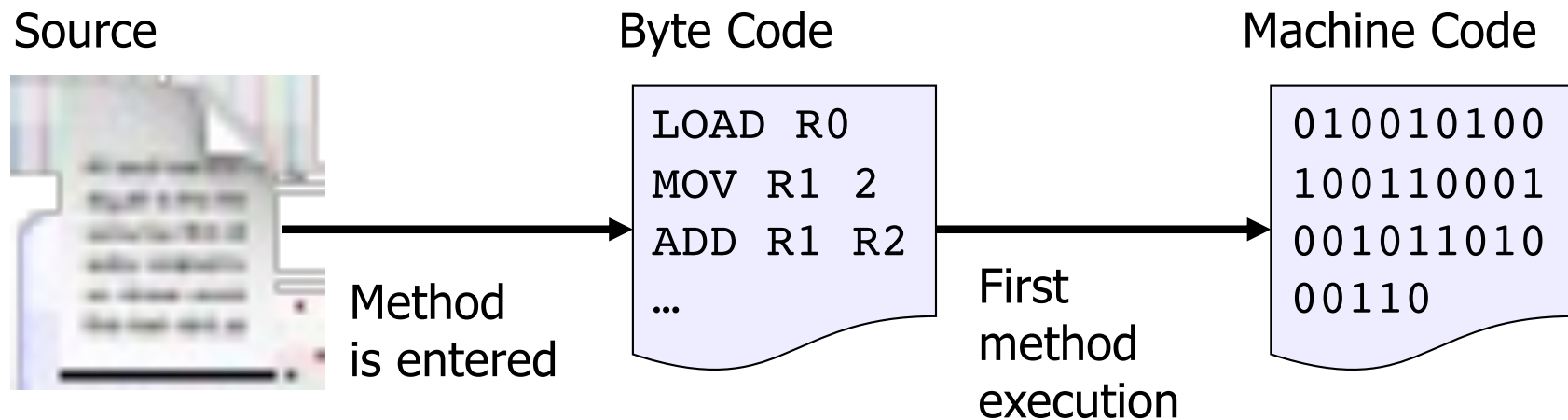

- Method is converted to byte codes when entered into the system
- Compiled to machine code when first executed
- Code stored in cache
 - if cache fills, previously compiled method flushed
- Requires entire source (byte) code to be available at runtime

Lookup Cache

- Cache of recently used methods, indexed by (receiver type, message name) pairs
- When a message is sent, compiler first consults cache
 - if found: invokes associated code
 - if absent: performs general lookup and potentially updates cache
- Berkeley Smalltalk would have been 37% slower without this optimization

Static Type Prediction

- Compiler predicts types that are unknown but likely:
 - Arithmetic operations (+, -, <, *etc.*) have small integers as their receivers 95% of time in Smalltalk-80
 - ifTrue had Boolean receiver 100% of the time.
- Compiler inlines code (and test to confirm guess):

```
if type = smallInt jump to method_smallInt  
call general_lookup
```

Inline Caches

- First message send from a *call site* :
 - general lookup routine invoked & backpatch
- Call site back-patched previously
 - is previous method still correct?
 - yes: invoke code directly
 - no: proceed with general lookup & backpatch
- Successful about 95% of the time
- All compiled implementations of Smalltalk and Self use inline caches.

Polymorphic Inline Caches

- Typical call site has <10 distinct receiver types
 - Often can cache *all* receivers
- At each call site, for each new receiver, extend patch code:

```
if type = rectangle jump to method_rect
if type = circle    jump to method_circle
call general_lookup
```

- After some threshold, revert to simple inline cache (**megamorphic site**)
- Order clauses by frequency
- Inline short methods into PIC code

Customized Compilation

- Compile several copies of each method, one for each receiver type
- Within each copy:
 - Compiler knows the type of self
 - Calls through self can be statically selected and inlined
- Enables downstream optimizations
- Increases code size

Type Analysis

- Constructed by compiler using flow analysis
- Type: set of possible maps for object
 - Singleton: know map statically
 - Union/Merge: know expression has one of a fixed collection of maps
 - Unknown: know nothing about expression
- If singleton, we can inline method
- If type is small, we can insert type test and create branch for each possible receiver (**type casing**)

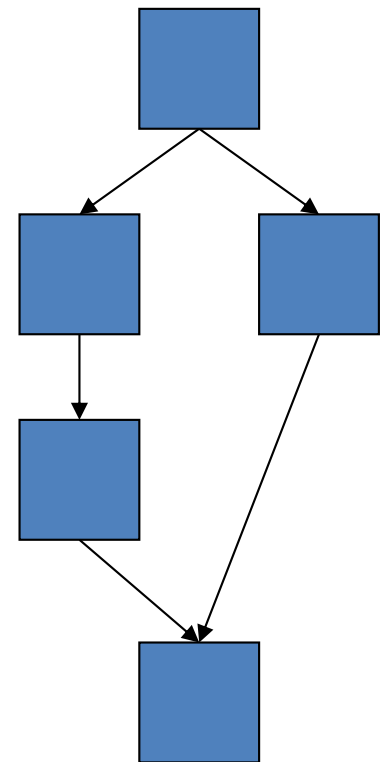

Message Splitting

- Type information above a merge point is often better
- Move message send “before” merge point:
 - duplicates code
 - improves type information
 - allows more inlining

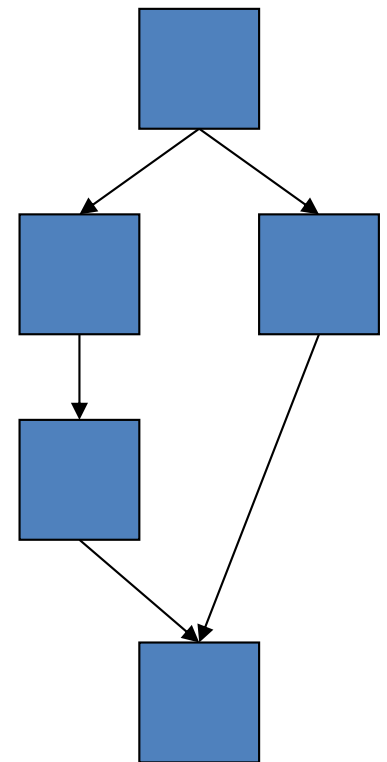

PICS as Type Source

- Polymorphic inline caches build a call-site specific type database *as the program runs*
- Compiler can use this runtime information rather than the result of a static flow analysis to build *type cases*
- Must wait until PIC has collected information
 - When to recompile?
 - What should be recompiled?
- Initial fast compile yielding slow code; then dynamically recompile – *hotspots*

Performance Improvements

- Initial version of Self was 4-5 times slower than optimized C
- Adding **type analysis** and **message splitting** got within a factor of 2 of optimized C
- Replacing type analysis with **PICS** improved performance by further 37%

Fairly recent Self compiler is within a factor of 2 of optimized C.

Impact on Java

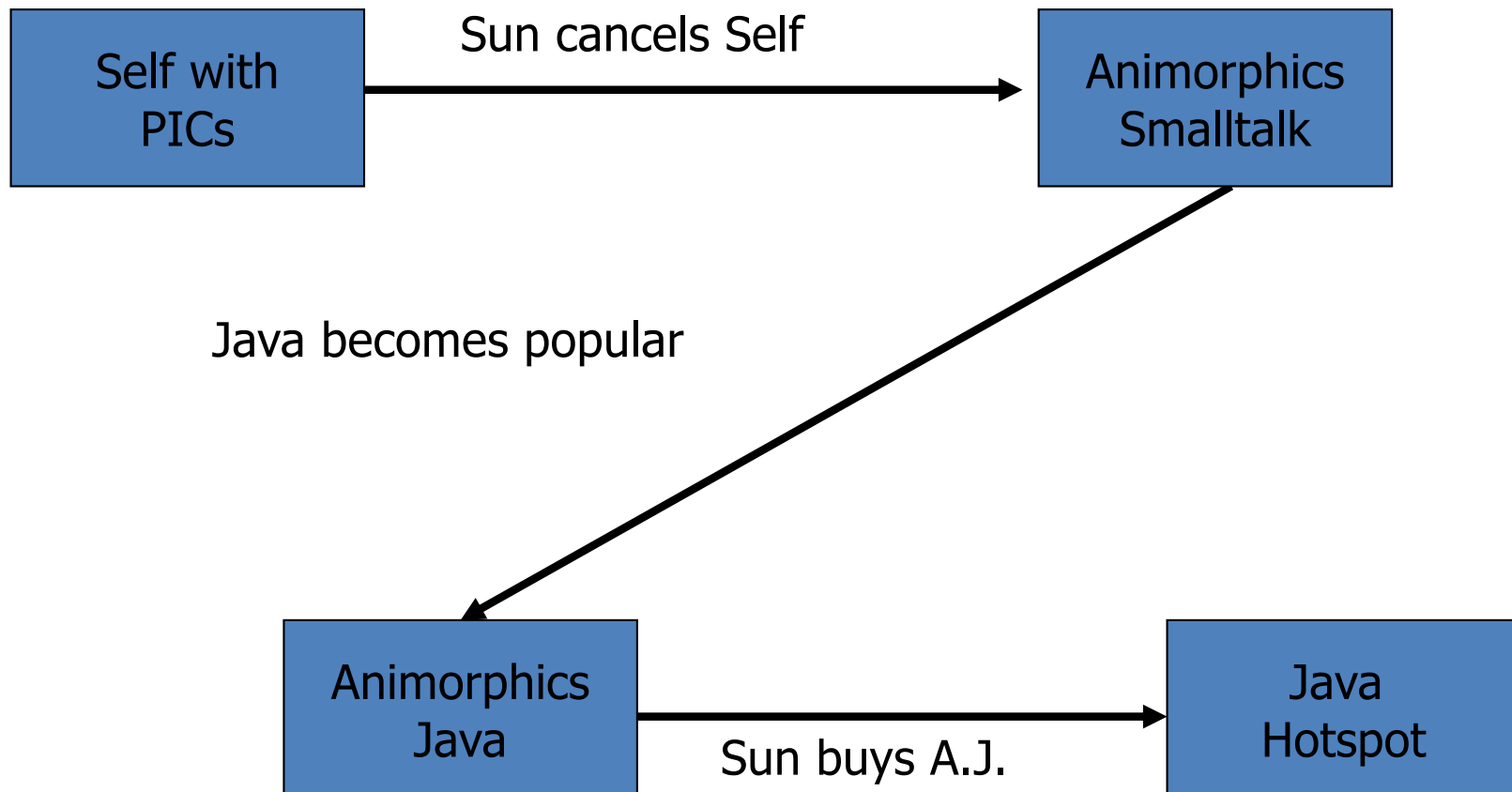

Summary of Self

- “Power of simplicity”
 - Everything is an object: no classes, no variables
 - Provides high-level model that can’t be violated (even during debugging)
- Fancy optimizations recover reasonable performance
- Many techniques now used in Java compilers
- Papers describing various optimization techniques available from Self web site

JavaScript

- Self-like language with Java syntax
 - Dynamic OO language
 - Prototypes instead of classes
 - Nothing to do with Java beyond syntax
- Originated in Netscape
- “Standard” on today’s browsers

High-performance JavaScript

- Self approach:
 - V8 (Google Chrome)
 - SquirrelFish Extreme (Safari / WebKit)
- Trace compilation:
 - TraceMonkey (Firefox)
 - Tamarin (Adobe Flash/Flex)

V8 (Google Chrome)

- Three primary features
 - Fast property access
 - Hidden classes
 - Dynamic compiler
 - Compile on first invocation
 - Inline caching with back patching
 - Generational garbage collection
 - Segmented by types
- See <http://code.google.com/apis/v8/design.html>

Trace-Based Compilation

- Interpret initially
- Record trace information
 - Single entry, multiple exit
 - Loop header is typically trace start
- Compile hot trace (hot path through flowgraph)
 - Interpreter jumps to trace code when available
 - Stitch multiple traces together
- Specialize hot path (omit redundant checks)
 - Claim this achieves benefits of inline caching

Conclusions?

- For you to decide...