



CSE 332: Data Structures & Parallelism

Lecture 22: Minimum Spanning Trees

Ruth Anderson
Winter 2023

Minimum Spanning Trees

Given an undirected graph $G=(V,E)$, find a graph $G'=(V, E')$ such that:

- E' is a subset of E
- $|E'| = |V| - 1$
- G' is connected

G' is a minimum spanning tree.

- $\sum_{(u,v) \in E'} c_{uv}$ is minimal

Applications:

- Example: Electrical wiring for a house or clock wires on a chip
- Example: A road network if you cared about asphalt cost rather than travel time

Student Activity

Find the MST

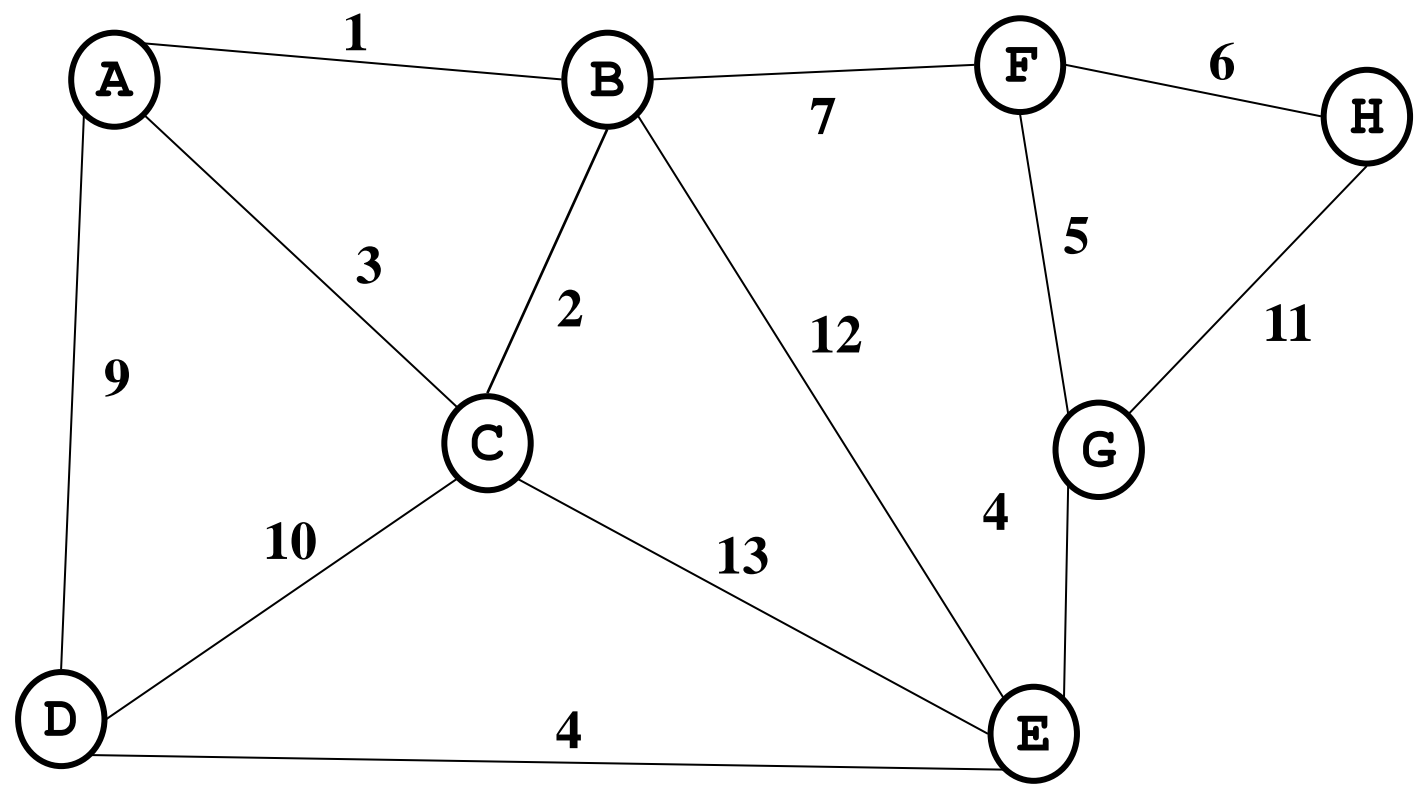
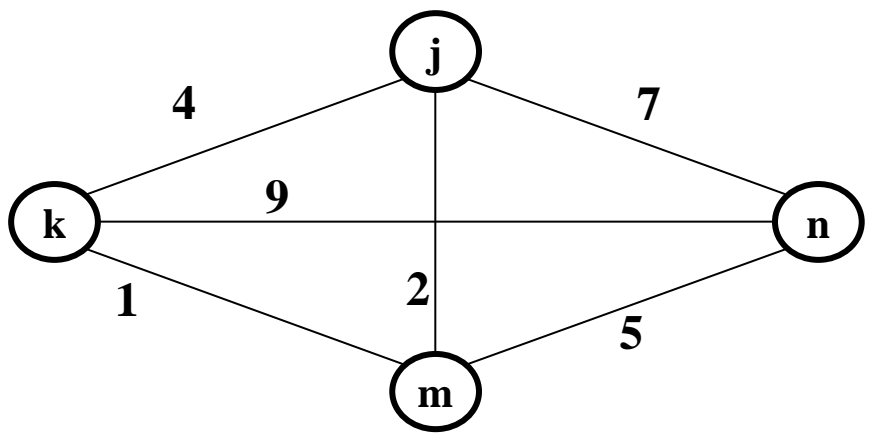

Two Different Approaches

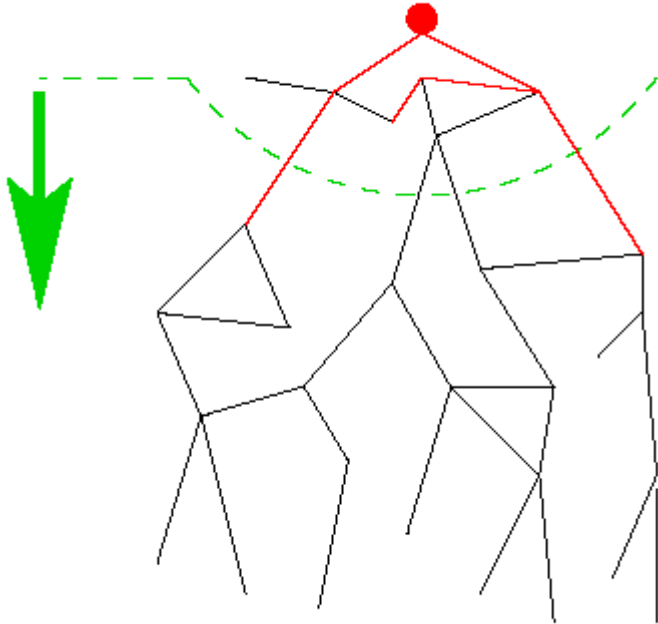

Prim's Algorithm

Almost identical to Dijkstra's

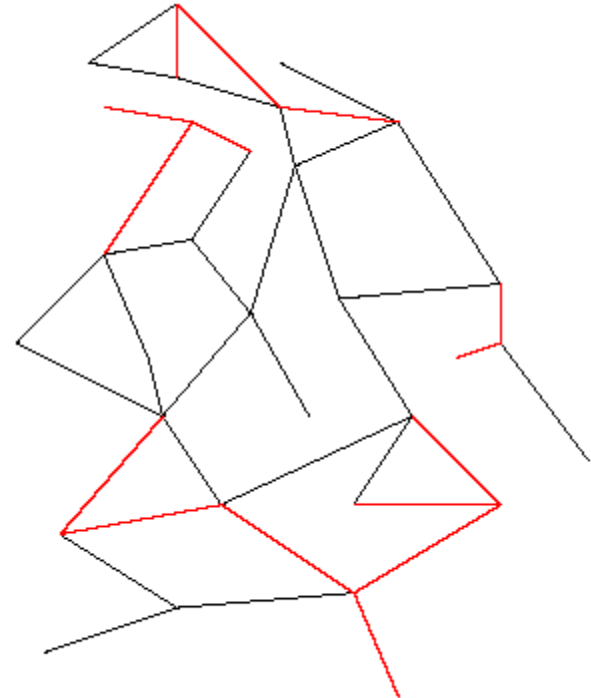

Kruskals's Algorithm

Completely different!

Prim's algorithm

Idea: Grow a tree by picking a vertex from the unknown set that has the smallest cost. Here cost = cost of the edge that connects that vertex to the known set. *Pick the vertex with the smallest cost that connects “known” to “unknown.”*

A node-based greedy algorithm

Builds MST by greedily adding nodes

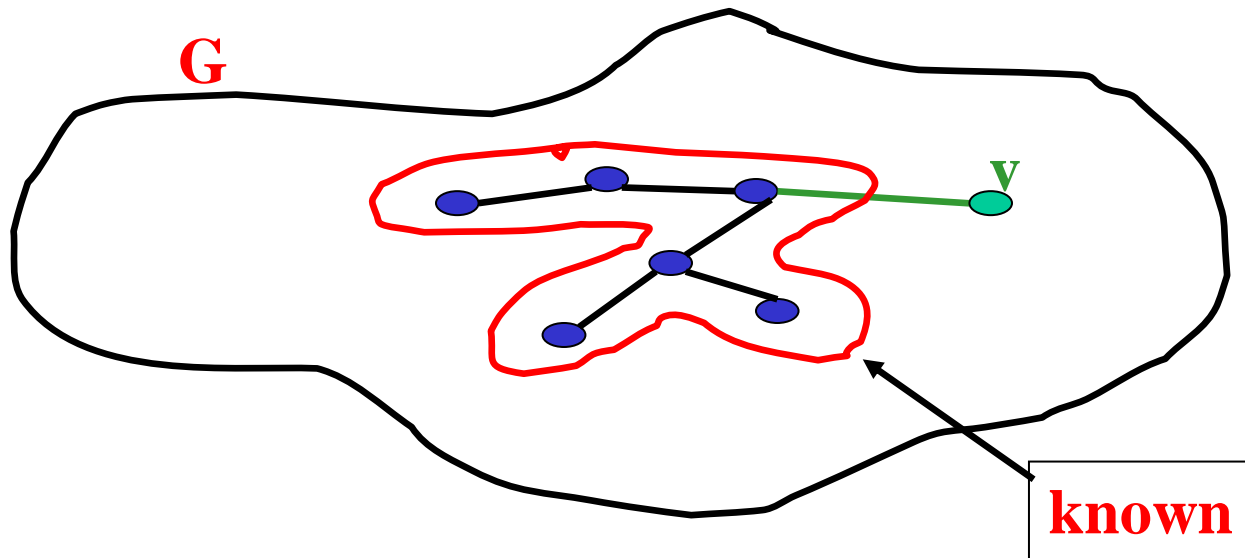

Prim's Algorithm vs. Dijkstra's

Recall:

Dijkstra picked the unknown vertex with smallest cost where
cost = *distance to the source*.

Prim's pick the unknown vertex with smallest cost where
cost = *distance from this vertex to the known set* (in other words,
the cost of the smallest edge connecting this vertex to the known
set)

- Otherwise identical
- Compare to slides in Dijkstra lecture!

Prim's Algorithm for MST

1. For each node v , set $v.cost = \infty$ and $v.known = false$
2. Choose any node v . (this is like your “start” vertex in Dijkstra)
 - a) Mark v as known
 - b) For each edge (v, u) with weight w :
set $u.cost = w$ and $u.prev = v$
3. While there are unknown nodes in the graph
 - a) Select the unknown node v with lowest **cost**
 - b) Mark v as known and add $(v, v.prev)$ to output (the MST)
 - c) For each edge (v, u) with weight w , where u is unknown:

```
if(w < u.cost) {  
    u.cost = w;  
    u.prev = v;  
}
```

Example: Find MST using Prim's

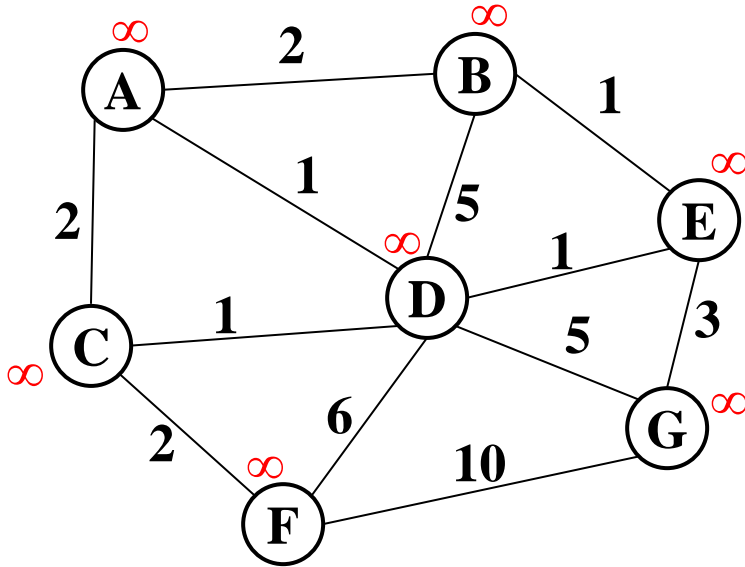

Order added to known set:

vertex	known?	cost	prev
A			
B			
C			
D			
E			
F			
G			

Start with V_1

Find MST using Prim's

V	Kwn	Distance	path
v1			
v2			
v3			
v4			
v5			
v6			
v7			

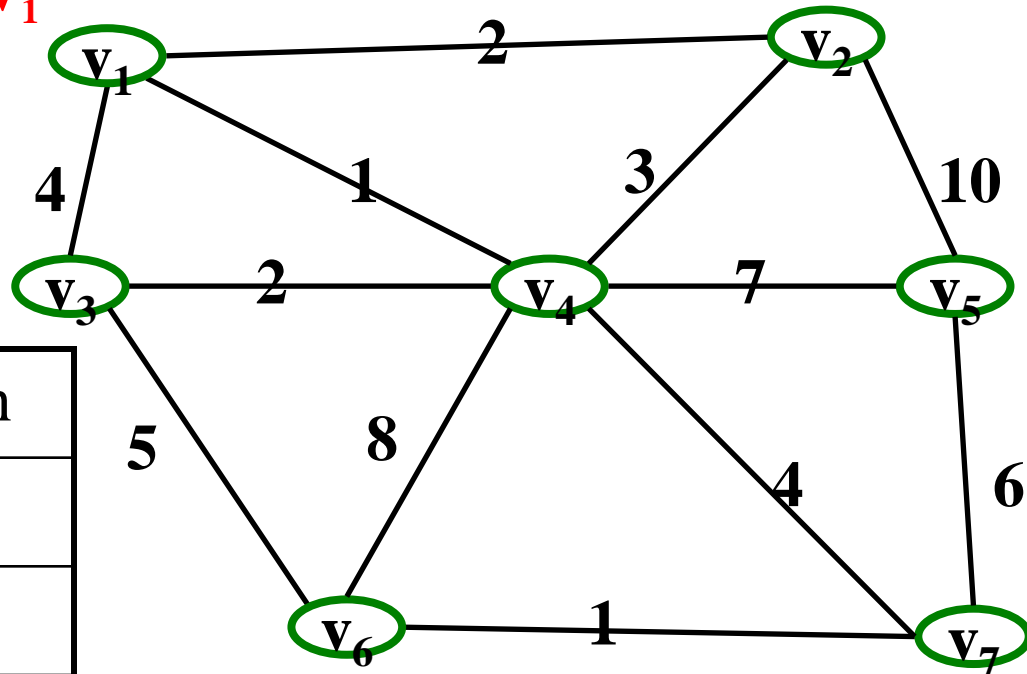

Order Declared Known:

V_1

Total Cost:

Prim's Analysis

- Correctness ??
 - A bit tricky
 - Intuitively similar to Dijkstra
 - Might return to this time permitting (unlikely)
- Run-time
 - Same as Dijkstra
 - $O(|E| \log |V|)$ using a priority queue

Kruskal's MST Algorithm

Idea: Grow a **forest** out of edges that do not create a cycle. Pick an edge with the smallest weight.

$G=(V,E)$

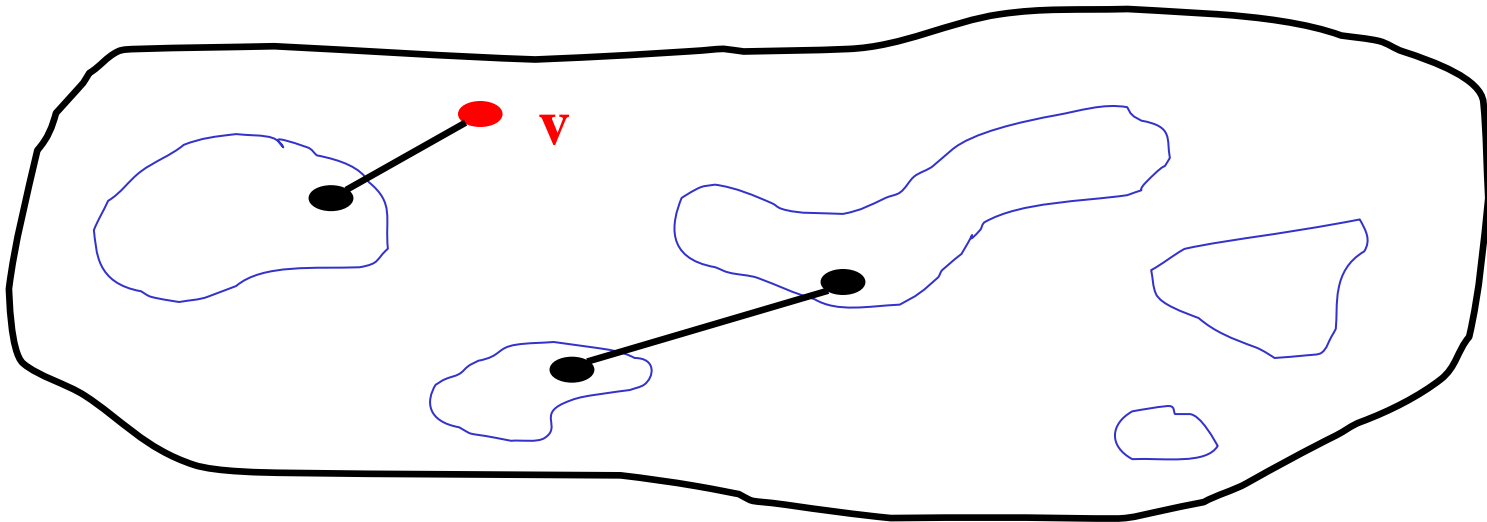

Kruskal's Algorithm for MST

An edge-based greedy algorithm

Builds MST by greedily adding edges

1. Initialize with
 - empty MST
 - all vertices marked unconnected
 - all edges unmarked
2. While all vertices are not connected
 - a. Pick the lowest cost edge (u, v) and mark it
 - b. If u and v are not already connected, add (u, v) to the MST and mark u and v as connected to each other

Aside: Union-Find aka Disjoint Set ADT

- **Union(x,y)** – take the union of two sets named x and y
 - Given sets: {3,5,7} , {4,2,8}, {9}, {1,6}
 - **Union(5,1)**
Result: {3,5,7,1,6}, {4,2,8}, {9},
 - To perform the union operation, we replace sets x and y by $(x \cup y)$
- **Find(x)** – return the name of the set containing x.
 - Given sets: {3,5,7,1,6}, {4,2,8}, {9},
 - **Find(1)** returns 5
 - **Find(4)** returns 8
- We can do Union in constant time.
- We can get Find to be **amortized** constant time (worst case $O(\log n)$ for an individual Find operation).

Kruskal's pseudo code

```
void Graph::kruskal() {
    int edgesAccepted = 0;
    DisjSet s(NUM_VERTICES);

    while (edgesAccepted < NUM_VERTICES - 1) {
        e = smallest weight edge not deleted yet;
        // edge e = (u, v)
        uset = s.find(u);
        vset = s.find(v);
        if (uset != vset) {
            edgesAccepted++;
            s.unionSets(uset, vset);
        }
    }
}
```

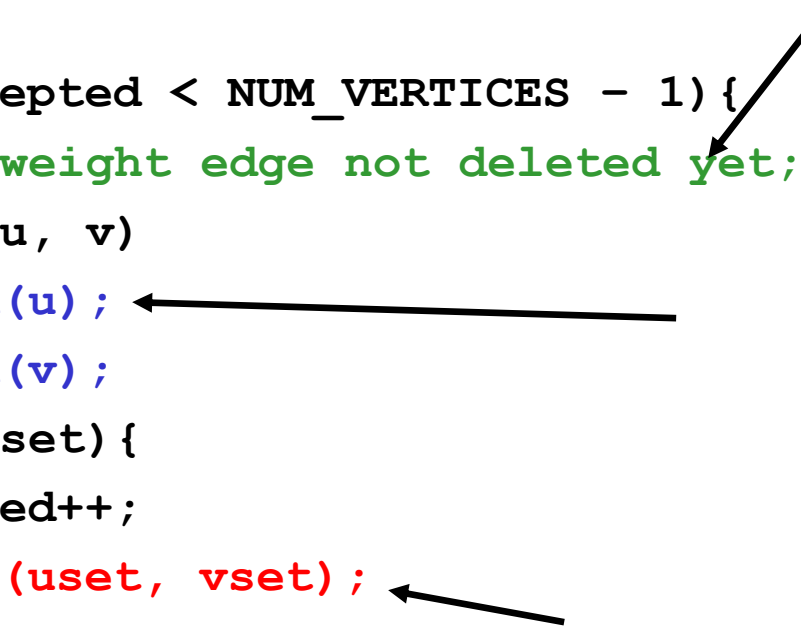

Example: Find MST using Kruskal's

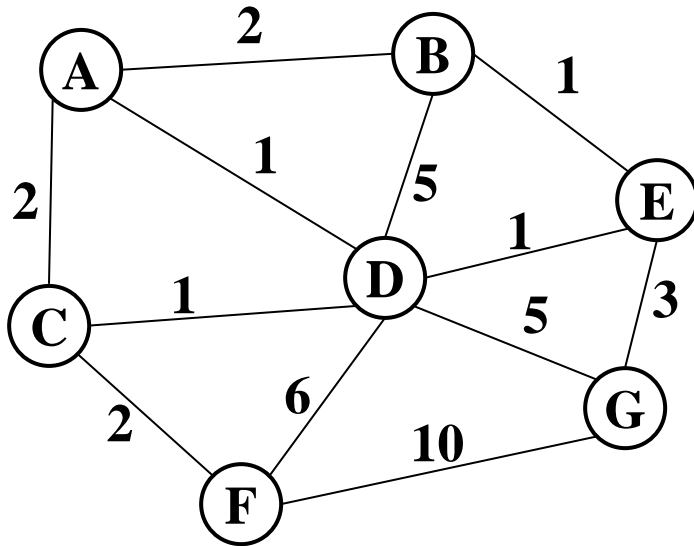

Edges in sorted order:

1: (A,D), (C,D), (B,E), (D,E)

2: (A,B), (C,F), (A,C)

3: (E,G)

5: (D,G), (B,D)

6: (D,F)

10: (F,G)

Output:

Note: At each step, the union/find sets are the trees in the forest

Find MST using Kruskal's

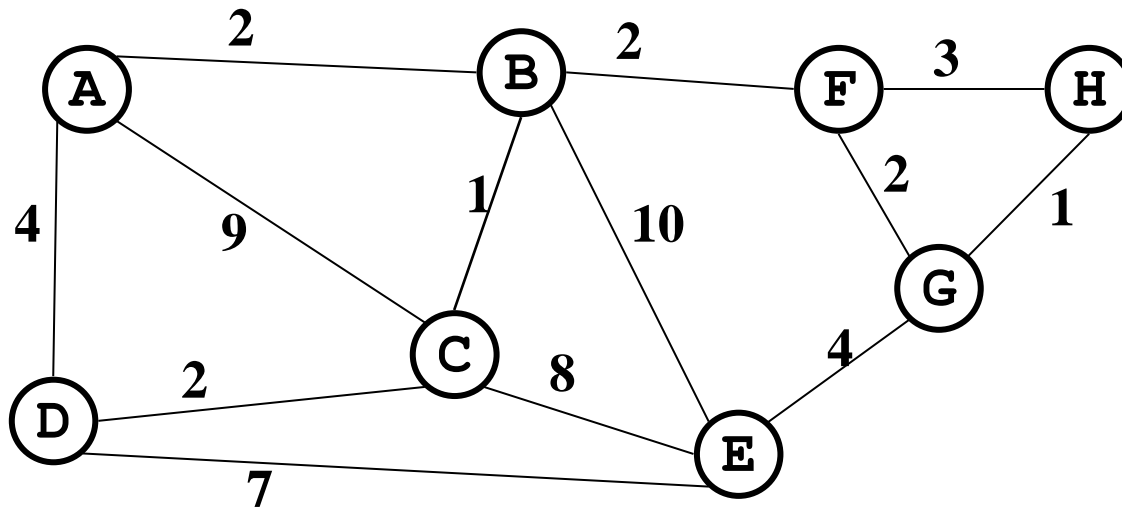

Total Cost:

- **Now find the MST using Prim's method.**
- **Under what conditions will these methods give the same result?**

Correctness

Kruskal's algorithm is clever, simple, and efficient

- But does it generate a minimum spanning tree?
- How can we prove it?

First: it generates a spanning tree

- Intuition: Graph started connected and we added every edge that did not create a cycle
- Proof by contradiction: Suppose u and v are disconnected in Kruskal's result. Then there's a path from u to v in the initial graph with an edge we could add without creating a cycle. But Kruskal would have added that edge. Contradiction.

Second: There is no spanning tree with lower total cost...

The inductive proof set-up

Let \mathbf{F} (stands for “forest”) be the set of edges Kruskal has added at some point during its execution.

Claim: \mathbf{F} is a subset of *one or more* MSTs for the graph
(Therefore, once $|\mathbf{F}|=|\mathbf{V}|-1$, we have an MST.)

Proof: By induction on $|\mathbf{F}|$

Base case: $|\mathbf{F}|=0$: The empty set is a subset of all MSTs

Inductive case: $|\mathbf{F}|=k+1$: By induction, before adding the $(k+1)^{\text{th}}$ edge (call it \mathbf{e}), there was some MST \mathbf{T} such that $\mathbf{F}-\{\mathbf{e}\} \subseteq \mathbf{T} \dots$

Staying a subset of **some** MST

Claim: **F** is a subset of *one or more* MSTs for the graph

So far: **F**-{**e**} \subseteq **T**:

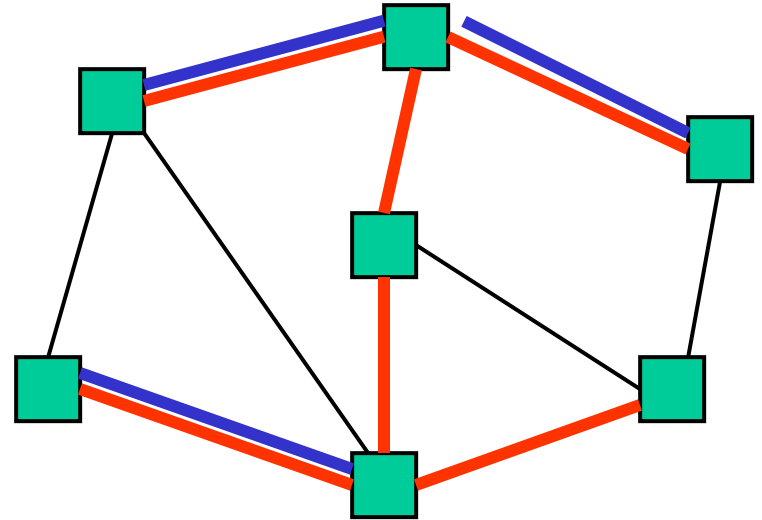

Two disjoint cases:

- If **{e}** \subseteq **T**: Then **F** \subseteq **T** and we're done
- Else **e** forms a cycle with some simple path (call it **p**) in **T**
 - Must be since **T** is a spanning tree

Staying a subset of **some** MST

Claim: **F** is a subset of *one or more* MSTs for the graph

So far: $\mathbf{F} - \{\mathbf{e}\} \subseteq \mathbf{T}$ and
 \mathbf{e} forms a cycle with $\mathbf{p} \subseteq \mathbf{T}$

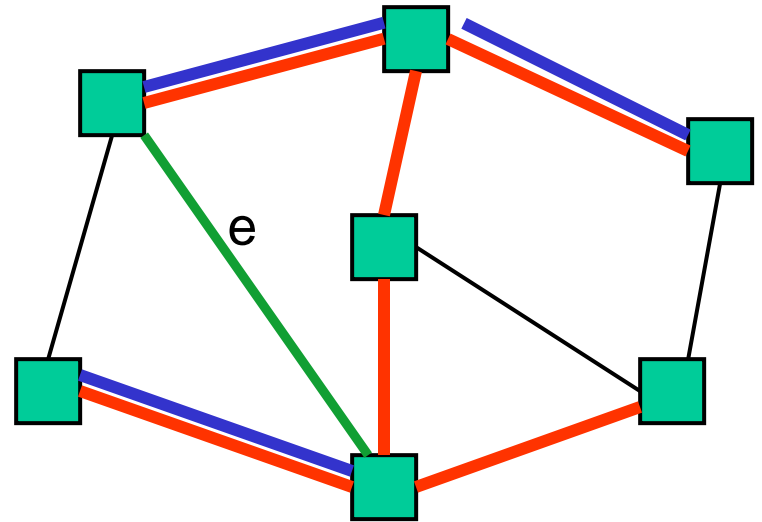

- There must be an edge **e2** on **p** such that **e2** is not in **F**
 - Else Kruskal would not have added **e**
- Claim: **e2.weight == e.weight**

Staying a subset of **some** MST

Claim: **F** is a subset of *one or more* MSTs for the graph

So far: **F** - {**e**} \subseteq **T**

e forms a cycle with **p** \subseteq **T**

e2 on **p** is not in **F**

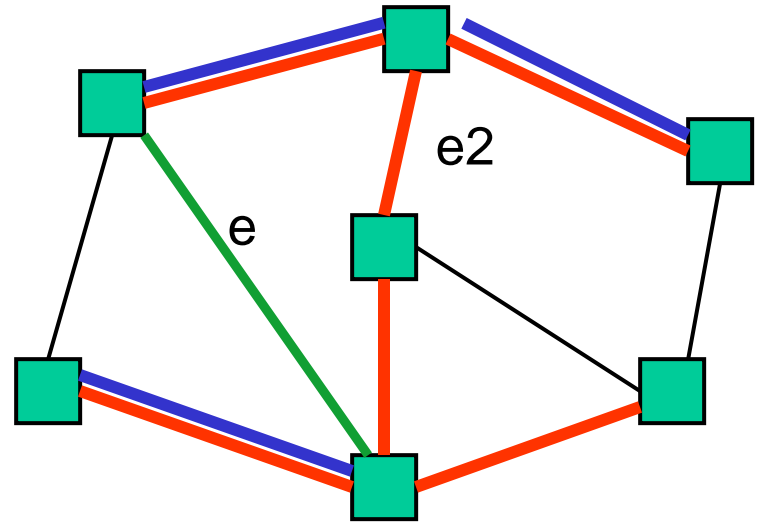

- Claim: **e2.weight == e.weight**
 - If **e2.weight > e.weight**, then **T** is not an MST because **T - {e2} + {e}** is a spanning tree with lower cost: contradiction
 - If **e2.weight < e.weight**, then Kruskal would have already considered **e2**. It would have added it since **T** has no cycles and **F - {e} \subseteq T**. But **e2** is not in **F**: contradiction

Staying a subset of **some** MST

Claim: **F** is a subset of *one or more* MSTs for the graph

So far: **F** - {**e**} \subseteq **T**

e forms a cycle with **p** \subseteq **T**

e2 on **p** is not in **F**

e2.weight == **e.weight**

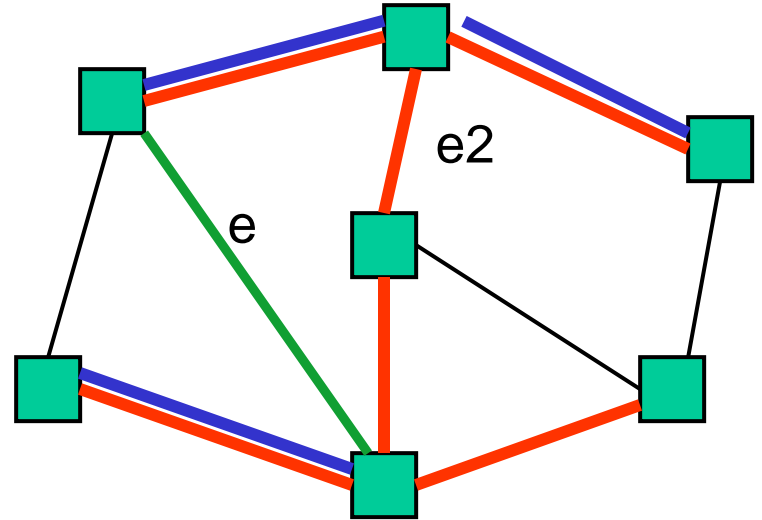

- Claim: **T** - {**e2**} + {**e**} is an MST
 - It's a spanning tree because **p** - {**e2**} + {**e**} connects the same nodes as **p**
 - It's minimal because its cost equals cost of **T**, an MST
- Since **F** \subseteq **T** - {**e2**} + {**e**}, **F** is a subset of one or more MSTs

Done.