



CSE 332: Data Structures & Parallelism

Lecture 19: Introduction to Graphs

Ruth Anderson
Spring 2023

Today

- Graphs
 - Intro & Definitions

Graphs

- A graph is a formalism for representing relationships among items
 - Very general definition because very general concept

- A graph is a pair

$$G = (V, E)$$

- A set of vertices, also known as nodes

$$V = \{v_1, v_2, \dots, v_n\}$$

- A set of edges

$$E = \{e_1, e_2, \dots, e_m\}$$

- Each edge e_i is a pair of vertices (v_j, v_k)
- An edge “connects” the vertices

- Graphs can be directed or undirected

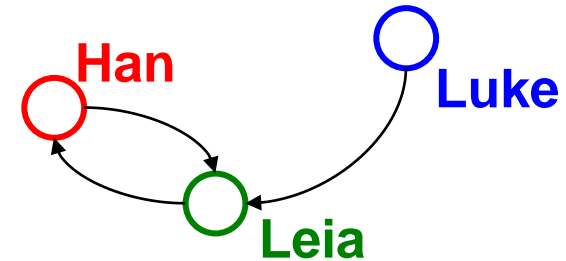

$$V = \{\text{Han}, \text{Leia}, \text{Luke}\}$$

$$E = \{(\text{Luke}, \text{Leia}), (\text{Han}, \text{Leia}), (\text{Leia}, \text{Han})\}$$

An ADT?

- Can think of graphs as an ADT with operations like `isEdge ((vj, vk))`
- But it is unclear what the “standard operations” are
- Instead we tend to develop algorithms over graphs and then use data structures that are efficient for those algorithms
- Many important problems can be solved by:
 1. Formulating them in terms of graphs
 2. Applying a standard graph algorithm
- To make the formulation easy and standard, we have a lot of *standard terminology* about graphs

Some graphs

For each, what are the **vertices** and what are the **edges**?

- Web pages with links
- Facebook friends
- “Input data” for the Kevin Bacon game
- Methods in a program that call each other
- Road maps (e.g., Google maps)
- Airline routes
- Family trees
- Course pre-requisites
- ...

Wow: Using the same algorithms for problems across so many domains sounds like “core computer science and engineering”

Undirected Graphs

- In **undirected graphs**, edges have no specific direction
 - Edges are always “two-way”

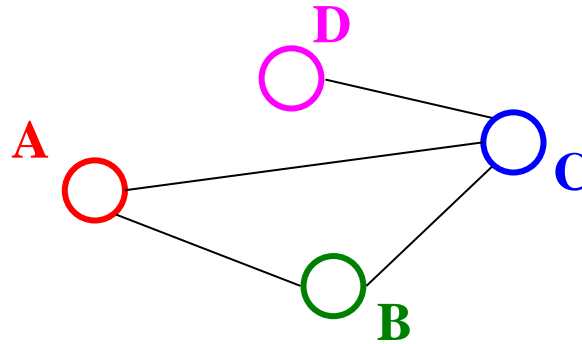

- Thus, $(u, v) \in E$ implies $(v, u) \in E$.
 - Only one of these edges needs to be in the set; the other is implicit
- **Degree** of a vertex: number of edges containing that vertex
 - Put another way: the number of adjacent vertices

Directed Graphs

- In **directed graphs** (sometimes called **digraphs**), edges have a direction

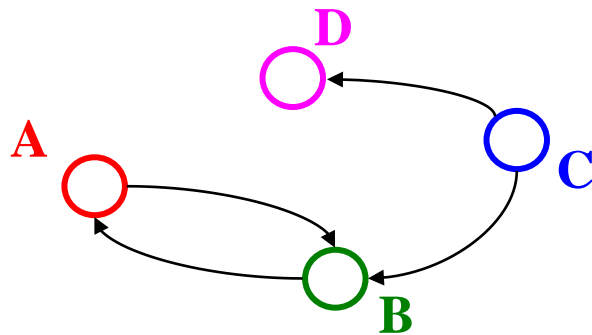

or

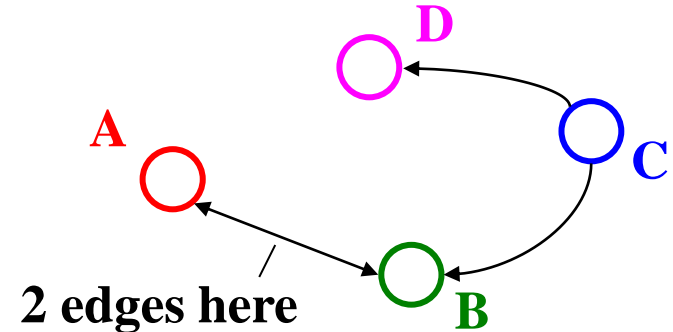

- Thus, $(u, v) \in \mathbf{E}$ does *not* imply $(v, u) \in \mathbf{E}$.
 - Let $(u, v) \in \mathbf{E}$ mean $u \rightarrow v$
 - Call u the **source** and v the **destination**
- In-Degree** of a vertex: number of in-bound edges, i.e., edges where the vertex is the destination
- Out-Degree** of a vertex: number of out-bound edges i.e., edges where the vertex is the source

Self-edges, connectedness

- A **self-edge** a.k.a. a **loop** is an edge of the form (u, u)
 - Depending on the use/algorithm, a graph may have:
 - No self edges
 - Some self edges
 - All self edges (often therefore implicit, but we will be explicit)
- A node can have a degree / in-degree / out-degree of **zero**
- A graph does not have to be **connected** (In an undirected graph, this means we can follow edges from any node to every other node), even if every node has non-zero degree

More notation

For a graph $G = (V, E)$:

- $|V|$ is the number of vertices
- $|E|$ is the number of edges
 - Minimum?
 - Maximum for undirected?
 - Maximum for directed?
- If $(u, v) \in E$
 - Then v is a **neighbor** of u , i.e., v is **adjacent** to u
 - Order matters for directed edges
 - u is not **adjacent** to v unless $(v, u) \in E$

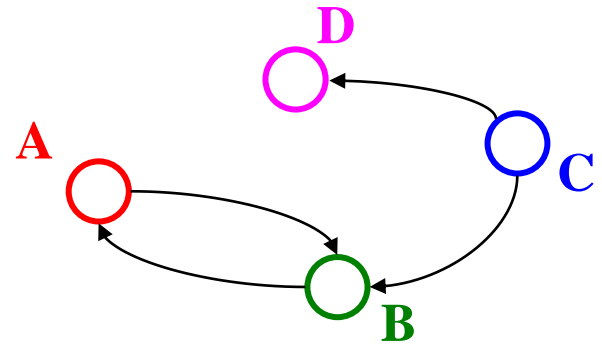

$$V = \{A, B, C, D\}$$

$$E = \{ (C, B), (A, B), (B, A), (C, D) \}$$

Examples again

Which would use **directed edges**? Which would have **self-edges**?
Which could have **0-degree nodes**?

- Web pages with links
- Facebook friends
- “Input data” for the Kevin Bacon game
- Methods in a program that call each other
- Road maps (e.g., Google maps)
- Airline routes
- Family trees
- Course pre-requisites
- ...

Weighted graphs

- In a weighed graph, each edge has a **weight** a.k.a. **cost**
 - Typically numeric (most examples will use ints)
 - *Orthogonal* to whether graph is directed
 - Some graphs allow *negative weights*; many don't

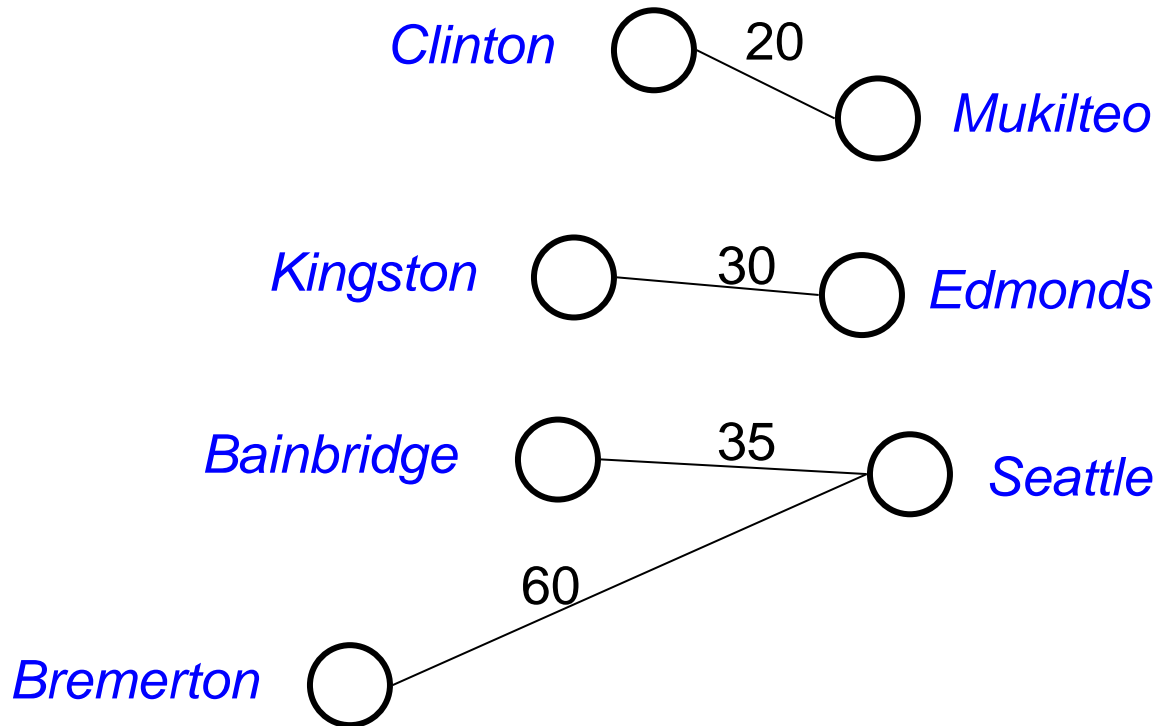

Examples

What, if anything, might **weights** represent for each of these? Do **negative weights** make sense?

- Web pages with links
- Facebook friends
- “Input data” for the Kevin Bacon game
- Methods in a program that call each other
- Road maps (e.g., Google maps)
- Airline routes
- Family trees
- Course pre-requisites
- ...

Paths and Cycles

- A **path** is a list of vertices $[v_0, v_1, \dots, v_n]$ such that $(v_i, v_{i+1}) \in E$ for all $0 \leq i < n$. Say “a path from v_0 to v_n ”
- A **cycle** is a path that begins and ends at the same node ($v_0 = v_n$)

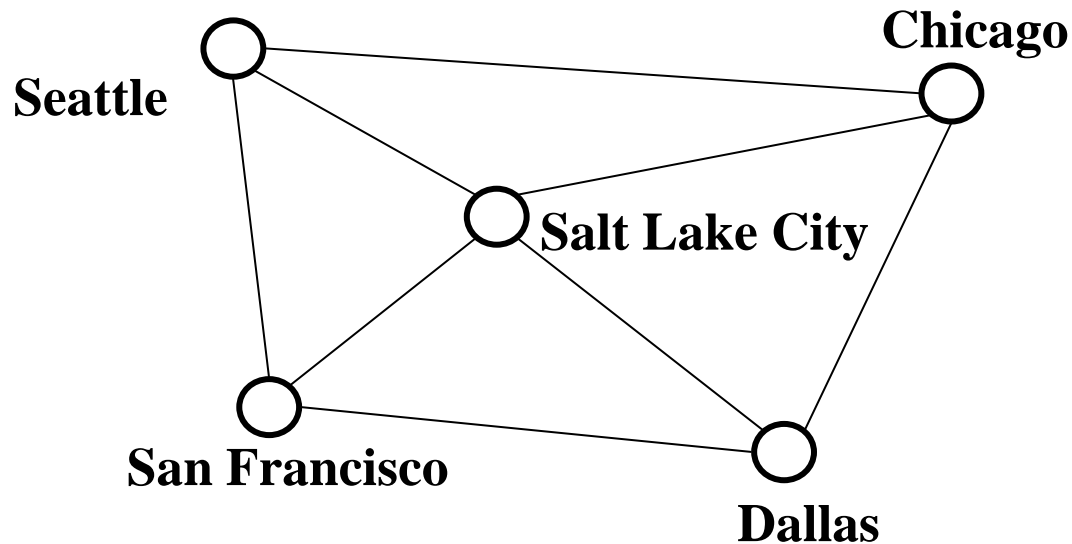

Example path (that also happens to be a cycle):

[Seattle, Salt Lake City, Chicago, Dallas, San Francisco, Seattle]

Path Length and Cost

- **Path length:** Number of *edges* in a path (also called “unweighted cost”)
- **Path cost:** Sum of the weights of each edge

Example where:

$P = [\text{Seattle}, \text{Salt Lake City}, \text{Chicago}, \text{Dallas}, \text{San Francisco}]$

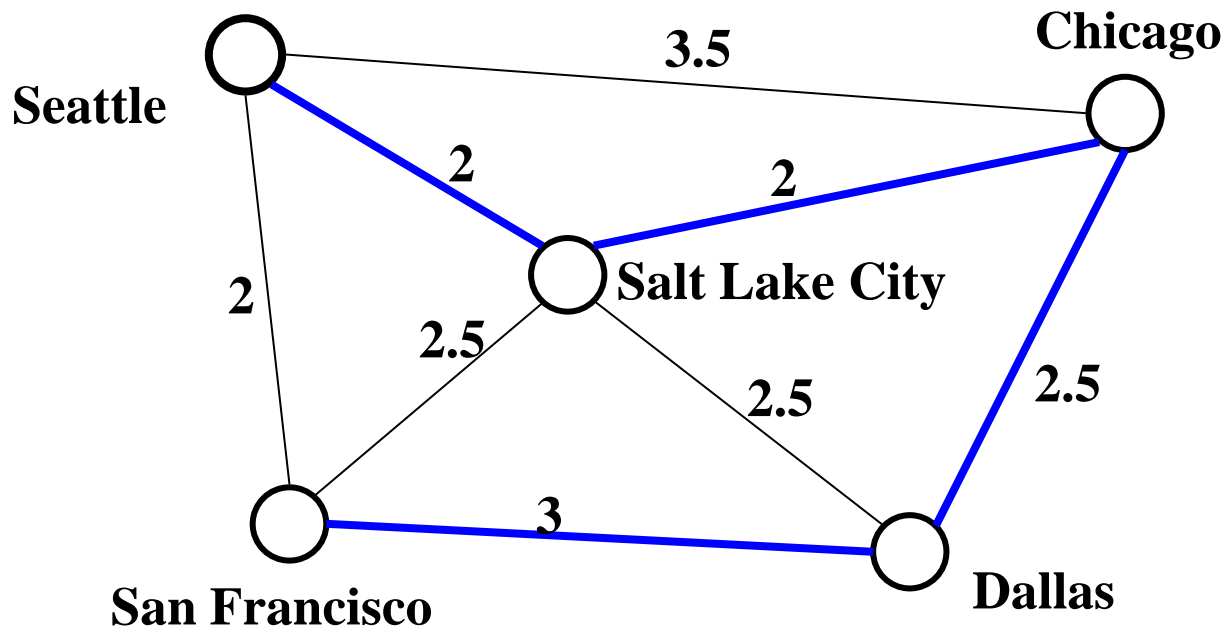

length(P) = 4
cost(P) = 9.5

Paths/cycles in directed graphs

Example:

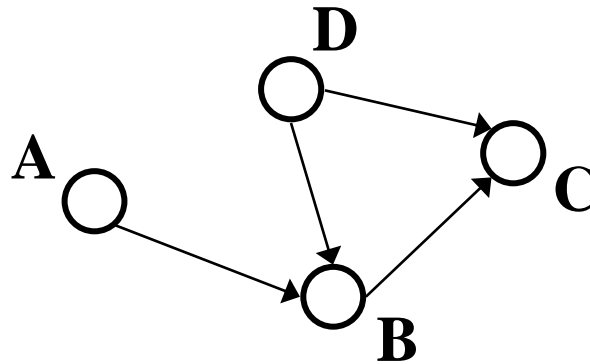

Is there a **path** from A to D?

Does the graph contain any **cycles**?

Undirected graph connectivity

- An undirected graph is **connected** if for all pairs of vertices u, v , there exists a *path* from u to v

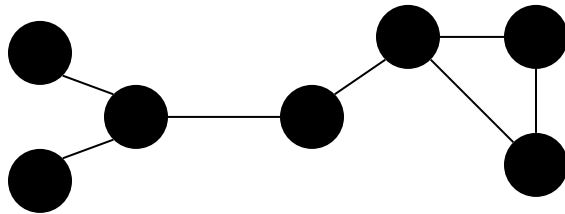

Connected graph

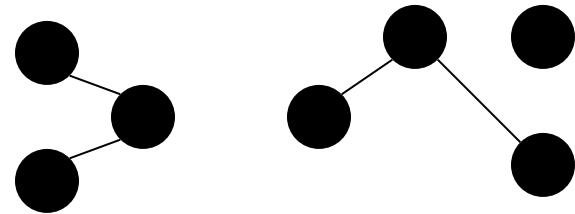

Disconnected graph

- An undirected graph is **complete**, a.k.a. **fully connected** if for all pairs of vertices u, v , there exists an edge from u to v

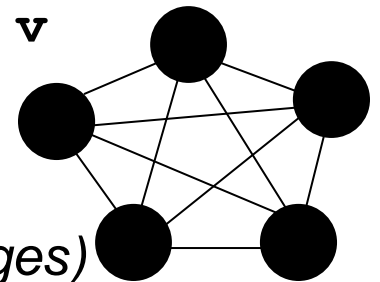

(plus self edges)

Directed graph connectivity

- A directed graph is **strongly connected** if there is a path from every vertex to every other vertex
- A directed graph is **weakly connected** if there is a path from every vertex to every other vertex *ignoring direction of edges*
- A **complete** a.k.a. **fully connected** directed graph has an edge from every vertex to every other vertex

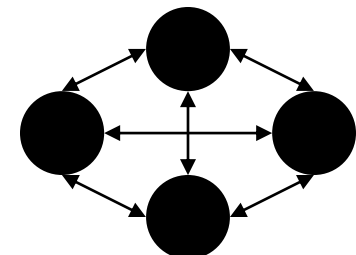
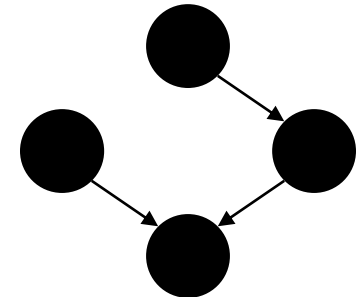
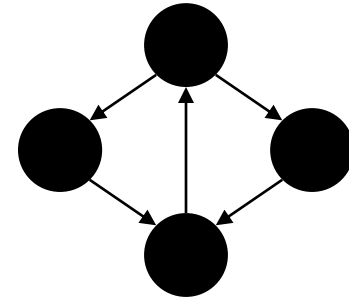

(plus self edges)

Examples

For undirected graphs: [connected](#)?

For directed graphs: [strongly connected](#)? [weakly connected](#)?

- Web pages with links
- Facebook friends
- “Input data” for the Kevin Bacon game
- Methods in a program that call each other
- Road maps (e.g., Google maps)
- Airline routes
- Family trees
- Course pre-requisites
- ...

Trees as graphs

When talking about graphs,
we say a **tree** is a graph that is:

- undirected
- acyclic
- connected

So all trees are graphs, but not
all graphs are trees

How does this relate to the trees
we know and love?...

Example:

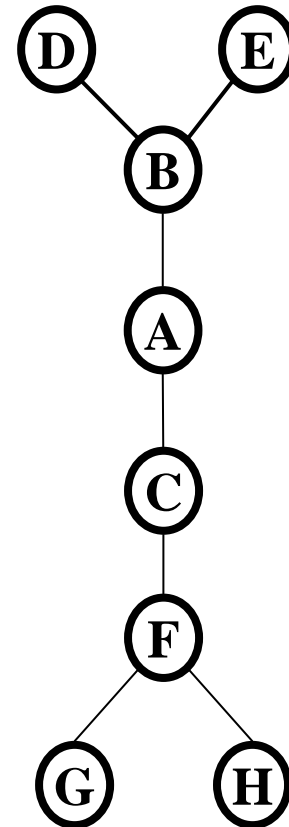

Rooted Trees

- We are more accustomed to **rooted trees** where:
 - We identify a unique (“special”) root
 - We think of edges as **directed**: parent to children
- Given a tree, once you pick a root, you have a unique rooted tree (just drawn differently and with undirected edges)

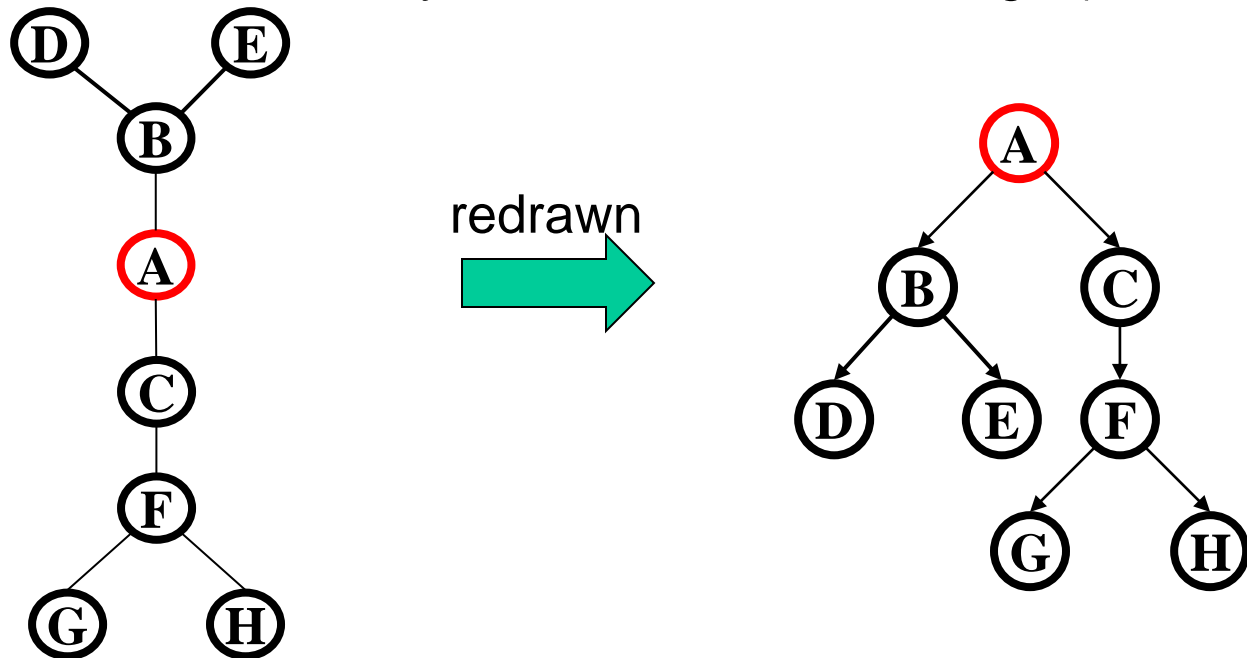

Rooted Trees (Another example)

- We are more accustomed to **rooted trees** where:
 - We identify a unique (“special”) root
 - We think of edges as **directed**: parent to children
- Given a tree, once you pick a root, you have a unique rooted tree (just drawn differently and with undirected edges)

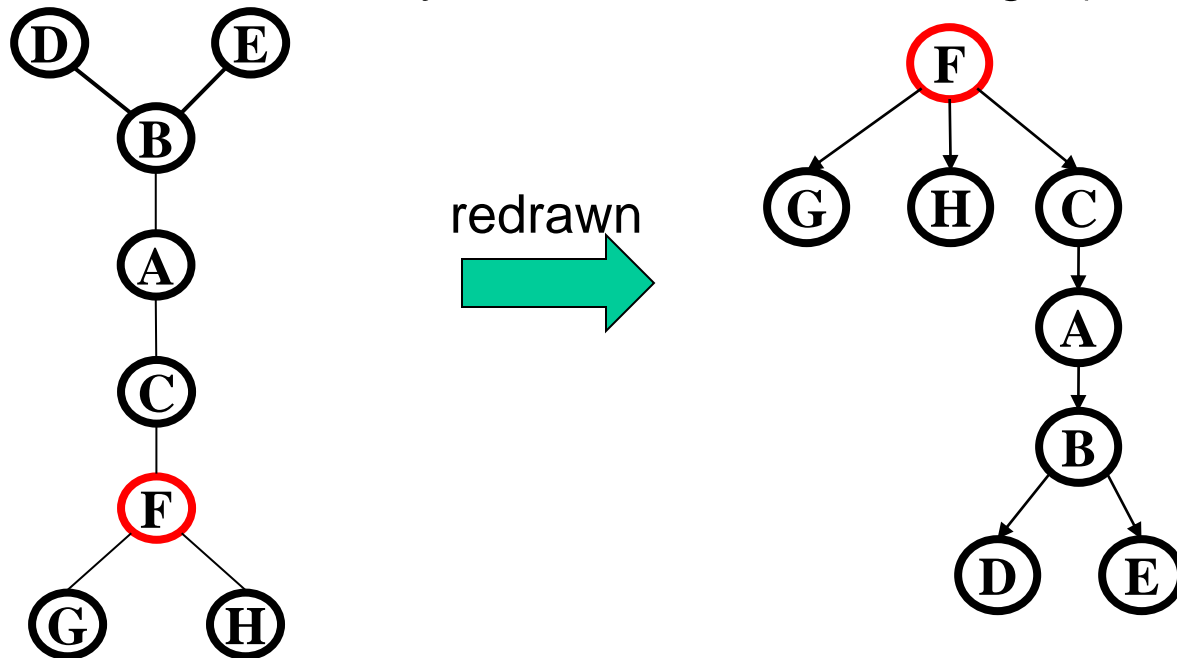

Directed acyclic graphs (DAGs)

- A **DAG** is a directed graph with no (directed) cycles
 - Every rooted directed tree is a DAG
 - But not every DAG is a rooted directed tree:

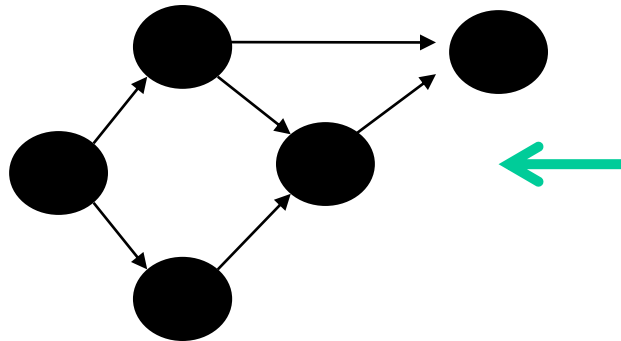

Not a rooted directed tree,
Has a cycle (in the
undirected sense)

- Every DAG is a directed graph
 - But not every directed graph is a DAG:

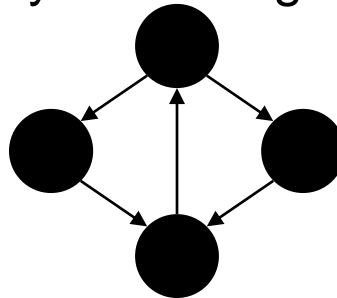

Examples

Which of our **directed**-graph examples do you expect to be a **DAG**?

- Web pages with links
- “Input data” for the Kevin Bacon game
- Methods in a program that call each other
- Airline routes
- Family trees
- Course pre-requisites
- ...

Density / sparsity

- Recall: In an undirected graph, $0 \leq |E| < |V|^2$
- Recall: In a directed graph: $0 \leq |E| \leq |V|^2$
- So for any graph, $|E|$ is $O(|V|^2)$
- One more fact: If an undirected graph is *connected*, then $|E| \geq |V|-1$
- Because $|E|$ is often much smaller than its maximum size, we do not always approximate as $|E|$ as $O(|V|^2)$
 - This is a correct bound, it just is often not tight
 - If it is tight, i.e., $|E|$ is $\Theta(|V|^2)$ we say the graph is **dense**
 - More sloppily, dense means “lots of edges”
 - If $|E|$ is $O(|V|)$ we say the graph is **sparse**
 - More sloppily, sparse means “most (possible) edges missing”

What is the Data Structure?

- So graphs are really useful for lots of data and questions
 - For example, “what’s the lowest-cost path from x to y ”
- But we need a data structure that represents graphs
- The “best one” can depend on:
 - Properties of the graph (e.g., dense versus sparse)
 - The common queries (e.g., “is (u, v) an edge?” versus “what are the neighbors of node u ?”)
- So we’ll discuss the two standard graph representations
 - [Adjacency Matrix](#) and [Adjacency List](#)
 - Different trade-offs, particularly time versus space

Adjacency matrix

- Assign each node a number from 0 to $|V| - 1$
- A $|V| \times |V|$ matrix (i.e., 2-D array) of Booleans (or 1 vs. 0)
 - If \mathbf{M} is the matrix, then $\mathbf{M}[\mathbf{u}][\mathbf{v}] == \mathbf{true}$ means there is an edge from \mathbf{u} to \mathbf{v}

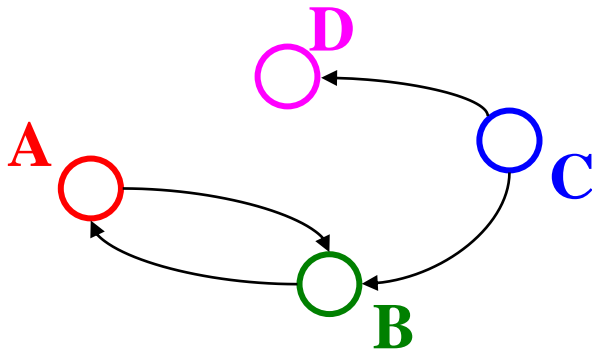

	A	B	C	D
A	F	T	F	F
B	T	F	F	F
C	F	T	F	T
D	F	F	F	F

Adjacency Matrix Properties

- Running time to:
 - Get a vertex's out-edges:
 - Get a vertex's in-edges:
 - Decide if some edge exists:
 - Insert an edge:
 - Delete an edge:
- Space requirements:
- Best for sparse or dense graphs?

	A	B	C	D
A	F	T	F	F
B	T	F	F	F
C	F	T	F	T
D	F	F	F	F

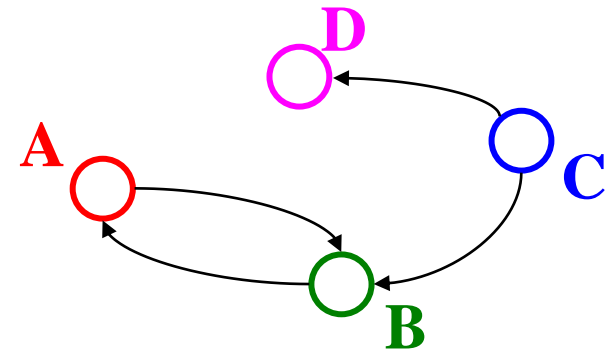

Adjacency Matrix Properties

- How will the adjacency matrix vary for an *undirected graph*?
- How can we adapt the representation for *weighted graphs*?

	A	B	C	D
A	F	T	F	F
B	T	F	F	F
C	F	T	F	T
D	F	F	F	F

Adjacency List

- Assign each node a number from 0 to $|\mathbf{V}| - 1$
- An array of length $|\mathbf{V}|$ in which each entry stores a list of all adjacent vertices (e.g., linked list)

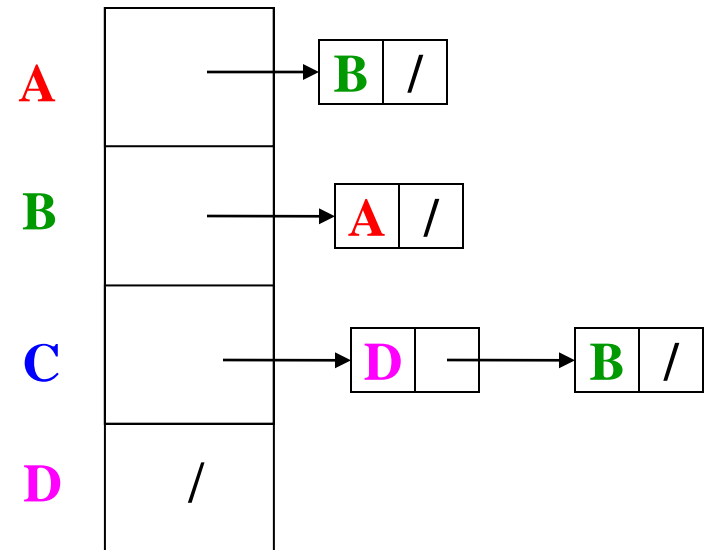
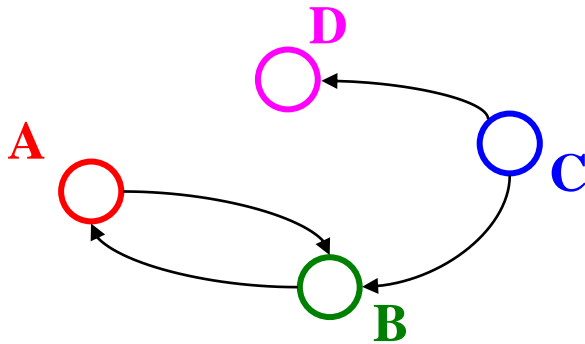

Adjacency List Properties

- Running time to:
 - Get all of a vertex's out-edges:
 - Get all of a vertex's in-edges:
 - Decide if some edge exists:
 - Insert an edge:
 - Delete an edge:
- Space requirements:
- Best for dense or sparse graphs?

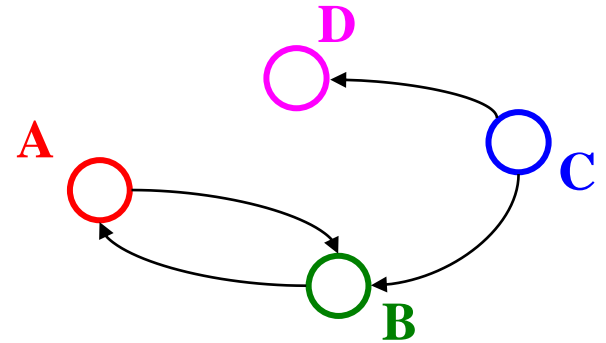
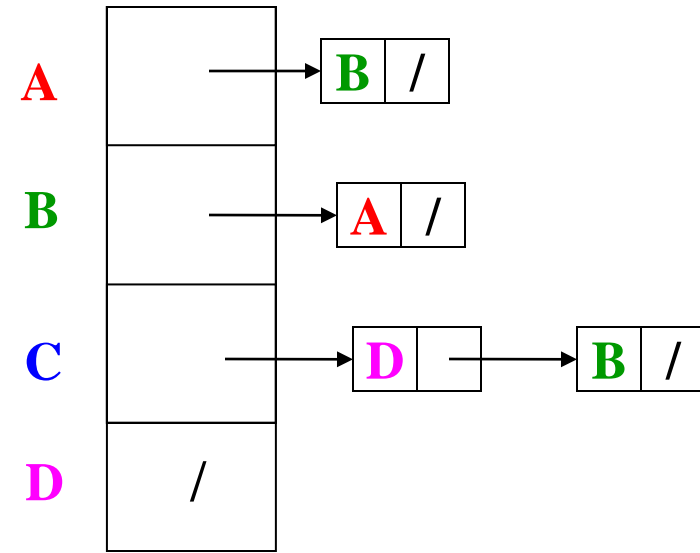

Undirected Graphs

Adjacency matrices & adjacency lists both do fine for undirected graphs

- Matrix: Can save roughly $\frac{1}{2}$ the space
 - But may slow down operations in languages with “proper” 2D arrays (not Java, which has only arrays of arrays)
 - How would you “get all neighbors”?
- Lists: Each edge in two lists to support efficient “get all neighbors”

Example:

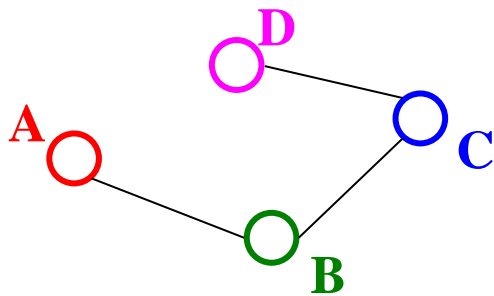

	A	B	C	D
A	F	T	F	F
B	T	F	T	F
C	F	T	F	T
D	F	F	T	F

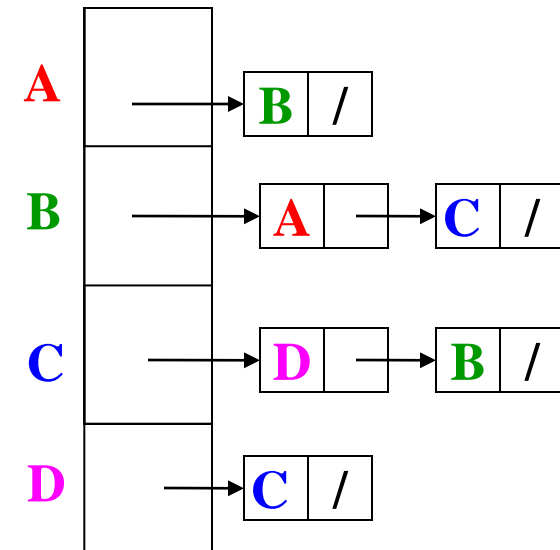

Which is better?

Graphs are often sparse:

- Streets form grids
 - every corner is not connected to every other corner
- Airlines rarely fly to all possible cities
 - or if they do it is to/from a hub rather than directly to/from all small cities to other small cities

Adjacency lists should generally be your default choice

- Slower performance compensated by greater space savings

Next...

Okay, we can represent graphs

Now let's implement some useful and non-trivial algorithms

- **Graph Traversals:** Depth-first graph search (DFS) & Breadth-first graph search (BFS)
- **Shortest paths:** Find the shortest or lowest-cost path from x to y
 - Related: Determine if there even is such a path