



# CSE 332: Data Structures & Parallelism

## Lecture 9: B Trees

Ruth Anderson  
Winter 2021

# *Today*

- Finish up AVL Trees
- The Memory Hierarchy and you (briefly)
- Dictionaries
  - B-Trees

# *Now what?*

- We have a data structure for the dictionary ADT (AVL tree) that has worst-case  $O(\log n)$  behavior
  - One of several interesting/fantastic balanced-tree approaches
- We are about to learn another balanced-tree approach: B Trees
- First, to motivate why B trees are better for really large dictionaries (say, over 1GB =  $2^{30}$  bytes), need to understand some ***memory-hierarchy basics***
  - Don't always assume "every memory access has an unimportant  $O(1)$  cost"
  - Learn more in CSE351/333/471, focus here on relevance to data structures and efficiency

# *Why do we need to know about the memory hierarchy?*

- One of the assumptions that Big-Oh makes is that all operations take the same amount of time.
- Is that really true?

# A typical hierarchy

*“Every desktop/laptop/server is different” but here is a plausible configuration these days*

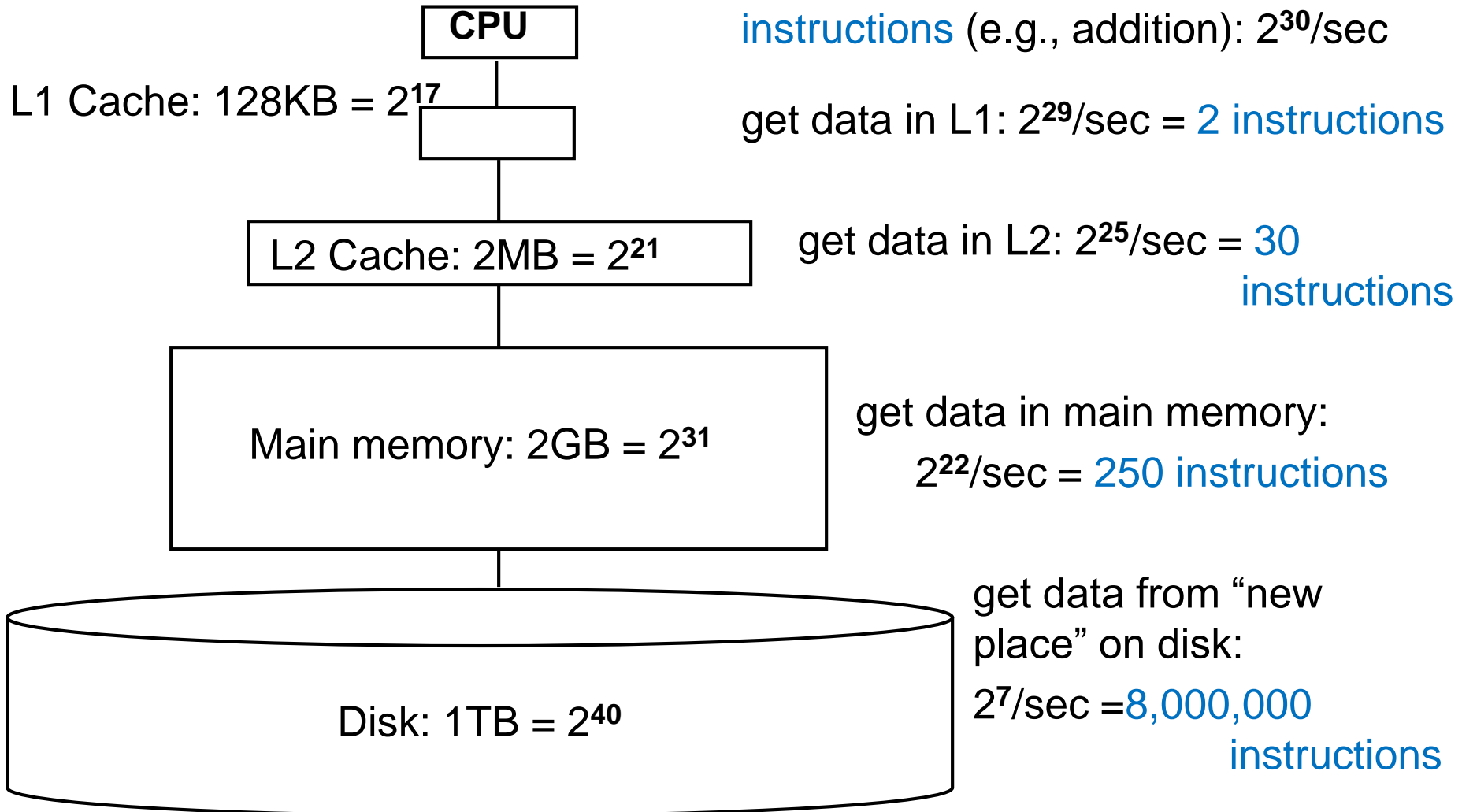

# *Morals*

It is much faster to do:	Than:
5 million arithmetic ops	1 disk access
2500 L2 cache accesses	1 disk access
400 main memory accesses	1 disk access

Why are computers built this way?

- Physical realities (speed of light, closeness to CPU)
- Cost (price per byte of different technologies)
- Disks get much bigger not much faster
  - Spinning at 7200 RPM accounts for much of the slowness and unlikely to spin faster in the future
- Speedup at higher levels (e.g. a faster processor) makes lower levels *relatively slower*
- Later in the course: more than 1 CPU!

# *“Fuggedaboutit”, usually*

The hardware automatically moves data into the caches from main memory for you

- Replacing items already there
- So algorithms much faster if “data fits in cache” (often does)

Disk accesses are done by software (e.g., ask operating system to open a file or database to access some data)

So most code “just runs” but sometimes it’s worth designing algorithms / data structures with knowledge of memory hierarchy

- And when you do, you often need to know one more thing...

# How does data move up the hierarchy?

- Moving data up the memory hierarchy is slow because of *latency* (think distance-to-travel)
  - Since we're making the trip anyway, may as well carpool
    - Get a block of data in the same time it would take to get a byte
  - Sends nearby memory because:
    - It's easy
    - And likely to be asked for soon (think fields/arrays)
- Side note: Once a value is in cache, may as well keep it around for awhile; accessed once, a particular value is more likely to be accessed again in the **near future** (more likely than some random other value)

Spatial Locality

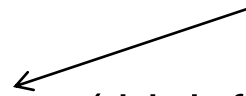

Temporal locality

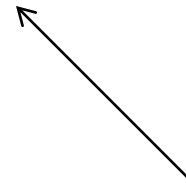



# Locality

**Temporal Locality** (locality in **time**) – If an address is referenced, **it** will tend to be referenced again soon.

**Spatial Locality** (locality in **space**) – If an address is referenced, **addresses that are close by** will tend to be referenced soon.

# *Arrays vs. Linked lists*

- Which has the potential to best take advantage of spatial locality?

# *Block/line size*

- The amount of data moved from **disk** into **memory** is called the “**block**” size or the “**page**” size
  - Not under program control
- The amount of data moved from **memory** into **cache** is called the cache “**line**” size
  - Not under program control

# Connection to data structures

- An **array** benefits more than a **linked list** from block moves
  - Language (e.g., Java) implementation can put the list nodes anywhere, whereas array is typically contiguous memory
- Suppose you have a queue to process with  $2^{23}$  items of  $2^7$  bytes each on disk and the block size is  $2^{10}$  bytes
  - An **array** implementation needs  $2^{20}$  disk accesses
    - If “perfectly streamed”,  $> 4$  seconds
    - If “random places on disk”, 8000 seconds ( $> 2$  hours)
  - A **list** implementation in the worst case needs  $2^{23}$  “random” disk accesses ( $> 16$  hours) – probably not that bad
- Note: “array” doesn’t necessarily mean “good”
  - Binary heaps “make big jumps” to percolate (different block)

# BSTs?

- Looking things up in balanced binary search trees is  $O(\log n)$ , so even for  $n = 2^{39}$  (512GB) we need not worry about minutes or hours
- Still, number of disk accesses matters:
  - Pretend for a minute we had an AVL tree of height 55
  - The total number of nodes could be? \_\_\_\_\_
  - Most of the nodes will be on disk: the tree is shallow, but it is still many gigabytes big so the entire *tree* cannot fit in memory
    - Even if memory holds the first 25 nodes on our path, we still potentially need 30 disk accesses if we are traversing the entire height of the tree.

## *Note about numbers; moral*

- **Note:** All the numbers in this lecture are “ballpark” “back of the envelope” figures
- **Moral:** Even if they are off by, say, a factor of 5, the moral is the same:

***If your data structure is mostly on disk,  
you want to minimize disk accesses***

- A better data structure in this setting would exploit the block size and relatively fast memory access to ***avoid disk accesses...***

# *Trees as Dictionaries*

(N= 10 million)

[Example from Weiss]

In worst case, each node access is a disk access,  
number of accesses:

# Disk accesses

- BST
- AVL
- B Tree

# *Our goal*

- **Problem:** A dictionary with so much data *most of it is on disk*
- **Desire:** A balanced tree (logarithmic height) that is even shallower than AVL trees so that we can minimize disk accesses and exploit disk-block size
- **A key idea:** Increase the branching factor of our tree



# *M-ary Search Tree*

- Build some sort of search tree with branching factor  $M$ :
  - Have an array of sorted children (**Node** [ ])
  - Choose  $M$  to fit snugly into a disk block (1 access for array)

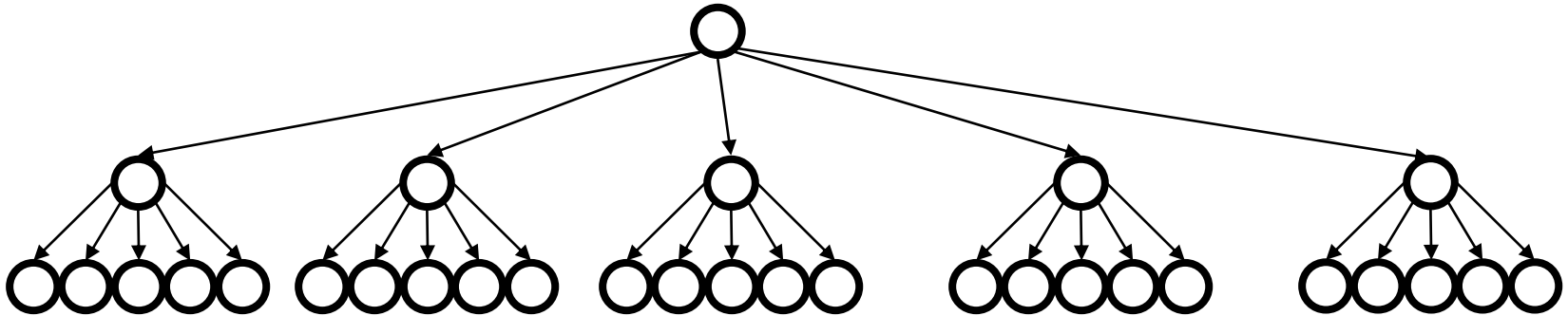

Perfect tree of height  $h$  has  $(M^{h+1}-1)/(M-1)$  nodes (textbook, page 4)

What is the **height** of this tree?

What is the worst case running time of **find**?

# M-ary Search Tree

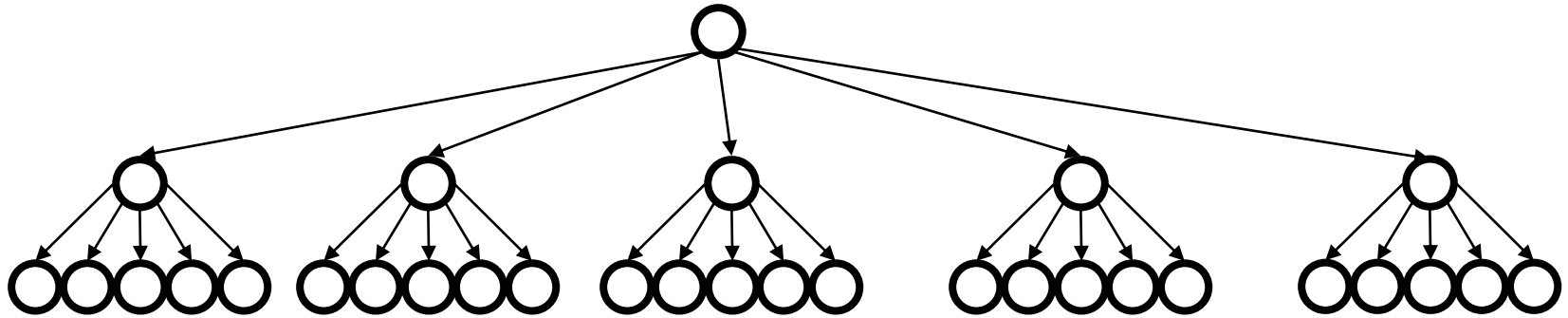

- # hops for `find`?
  - If we have a balanced M-ary tree:
  - Approx.  $\log_M n$  hops instead of  $\log_2 n$  (for balanced BST)
  - Example:  $M = 256 (=2^8)$  and  $n = 2^{40}$  that's 5 hops instead of 40 hops
- Sounds good, but how do we decide which branch to take?
  - Binary tree: Less than/greater than node value?
  - M-ary: In range 1? In range 2? In range 3?... In range M?
- Runtime of `find` if balanced:  $O(\log_2 M \log_M n)$ 
  - $\log_M n$  is the height we traverse.
  - $\log_2 M$ : At each step, find the correct child branch to take using binary search among the M options!

# Questions about *M*-ary search trees

- What should the **order** property be?
- How would you **rebalance** (ideally without more disk accesses)?
- Storing **real data** at inner-nodes (like we do in a BST) seems kind of wasteful...
  - To access the node, will have to load the **data** from disk, even though most of the time we won't use it!!
  - Usually we are just “passing through” a node on the way to the value we are actually looking for.

So let's use the branching-factor idea, but for a **different kind of balanced tree**:

- **Not** a binary *search tree*
- But still logarithmic height for any  $M > 2$

# B+ Trees (we and the book say “B Trees”)

- Two types of nodes: **internal nodes** & **leaves**
- Each **internal node** has room for up to  $M-1$  keys and  $M$  children
  - No other data; **all data at the leaves!**
- **Order property:**  
Subtree **between** keys  $a$  and  $b$  contains only data that is  $\geq a$  and  $< b$  (notice the  $\geq$ )
- **Leaf** nodes have up to  $L$  sorted data items
- As usual, we’ll ignore the “along for the ride” data in our examples
  - Remember no data at non-leaves

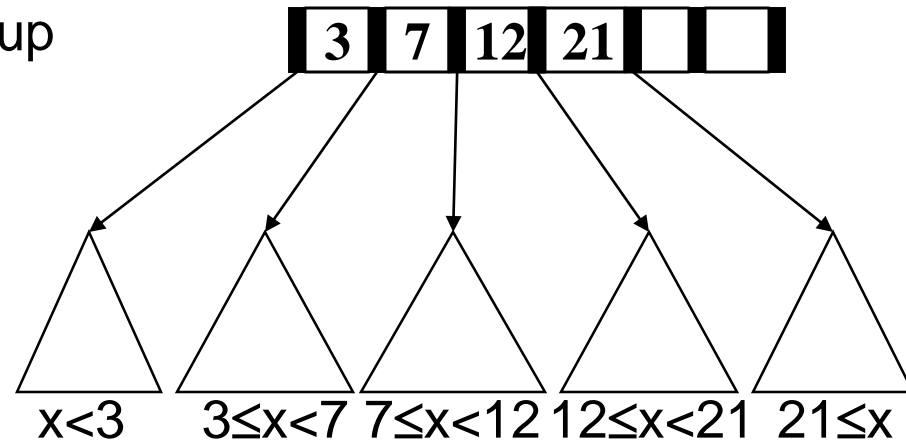

Remember:

- **Leaves** store data
- **Internal nodes** are ‘signposts’

# Find

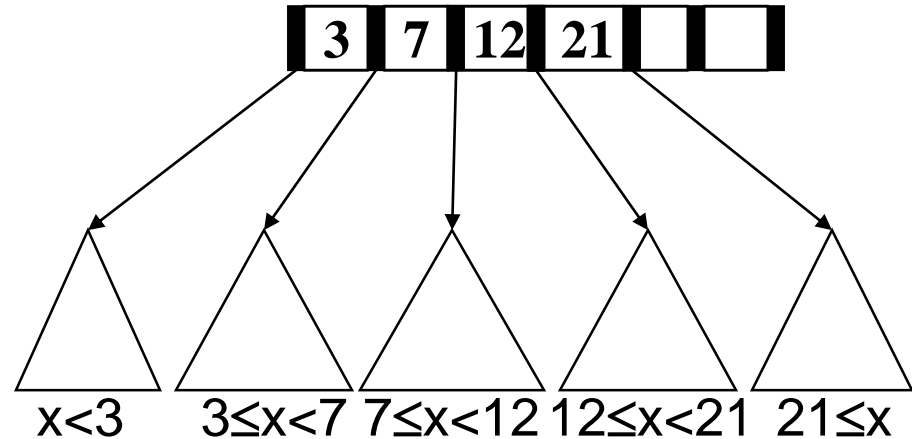

- Different from BST in that we don't store data at internal nodes
- But **find** is still an easy root-to-leaf recursive algorithm
  - At each internal node do binary search on (up to)  $M-1$  keys to find the branch to take
  - At the leaf do binary search on the (up to)  $L$  data items
- But to get logarithmic running time, we need a balance condition...

# Structure Properties

- **Root** (special case)
  - If tree has  $\leq L$  items, root is a leaf (occurs when starting up, otherwise unusual)
  - Else has between 2 and  $M$  children
- **Internal nodes**
  - Have between  $\lceil M/2 \rceil$  and  $M$  children, i.e., **at least half full**
- **Leaf nodes**
  - **All leaves at the same depth**
  - Have between  $\lceil L/2 \rceil$  and  $L$  data items, i.e., **at least half full**

Any  $M > 2$  and  $L$  will work, but:

We pick  $M$  and  $L$  **based on disk-block size**

**Note on notation: Inner nodes drawn horizontally, leaves vertically to distinguish. Include empty cells**

## *Example*

Suppose  $M=4$  (max # pointers in **internal node**)  
and  $L=5$  (max # data items at **leaf**)

- All **internal nodes** have at least 2 children
- All **leaves** have at least 3 data items (only showing keys)
- All **leaves** at same depth

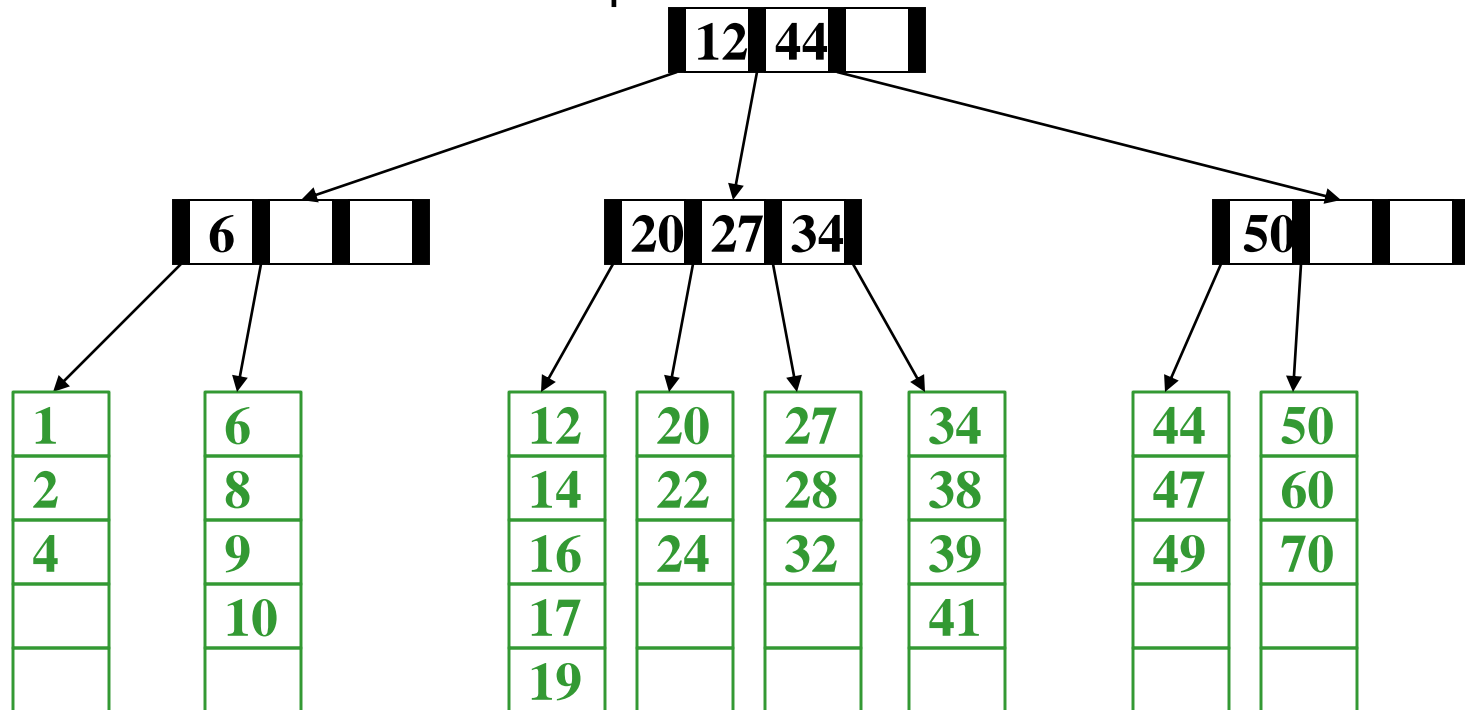

# Balanced enough

Not hard to show height  $h$  is logarithmic in number of data items  $n$

- Let  $M > 2$  (if  $M = 2$ , then a list tree is legal – no good!)
- Because all nodes are at least half full (except root may have only 2 children) and all leaves are at the same level, the minimum number of data items  $n$  for a height  $h > 0$  tree is...

$$n \geq \underbrace{2 \lceil M/2 \rceil^{h-1}}_{\text{minimum number of leaves}} \underbrace{\lceil L/2 \rceil}_{\text{minimum data per leaf}}$$



# *Example: B-Tree vs. AVL Tree*

Suppose we have 100,000,000 items

- Maximum height of AVL tree?
- Maximum height of B tree with  $M=128$  and  $L=64$ ?

# *Example: B-Tree vs. AVL Tree*

Suppose we have 100,000,000 items

- **Maximum height of AVL tree?**
  - Recall  $S(h) = 1 + S(h-1) + S(h-2)$
  - lecture8.xlsx reports: **37**
  
- **Maximum height of B tree** with  $M=128$  and  $L=64$ ?
  - Recall  $(2 \lceil M/2 \rceil^{h-1}) \lceil L/2 \rceil$
  - lecture9.xlsx reports: **5** (and 4 is more likely)
  - Also not difficult to compute via algebra

# *Disk Friendliness*

What makes B trees so disk friendly?

- Many keys stored in one **internal node**
  - All brought into memory in one disk access
    - *IF* we pick  $M$  wisely
  - Makes the binary search over  $M-1$  keys totally worth it (insignificant compared to disk access times)
- **Internal nodes** contain only keys
  - Any **find** wants only one data item; wasteful to load unnecessary items with internal nodes
  - So only bring one **leaf** of data items into memory
  - Data-item size doesn't affect what  $M$  is

# *Maintaining balance*

- So this seems like a great data structure (and it is)
- But we haven't implemented the other dictionary operations yet
  - **insert**
  - **delete**
- As with AVL trees, the hard part is maintaining structure properties
  - Example: for **insert**, there might not be room at the correct leaf

# Building a B-Tree (insertions)

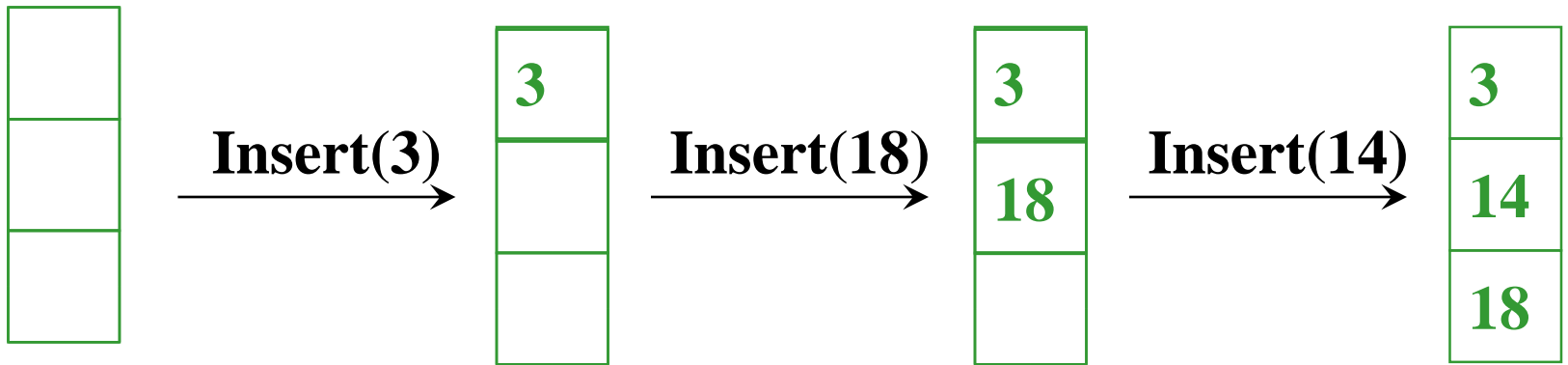

The empty B-Tree (the **root** will be a leaf at the beginning)

Just need to keep data in order

$$M = 3 \quad L = 3$$

$M = 3$   $L = 3$

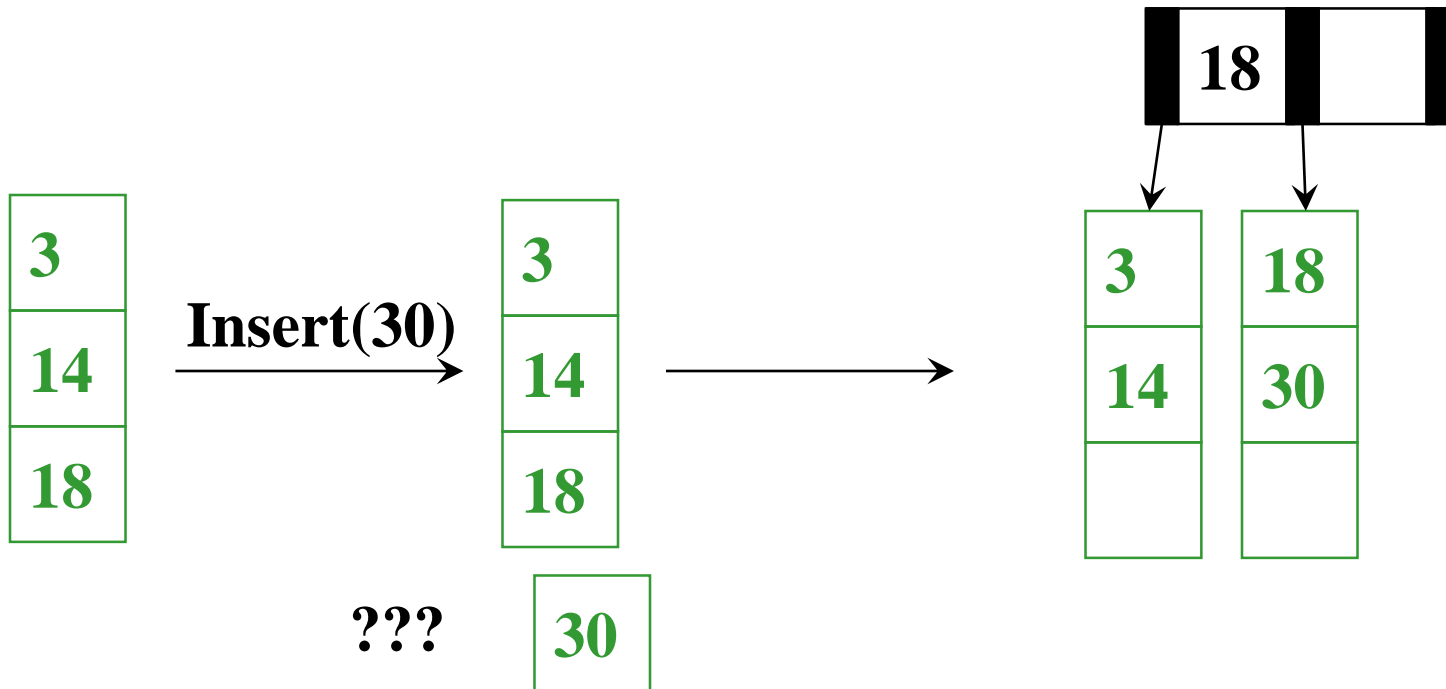

- When we ‘overflow’ a **leaf**, we split it into 2 leaves
- Parent gains another child
- If there is no parent (like here), we create one; how do we pick the key shown in it?
  - Smallest element in right tree

# Split leaf again

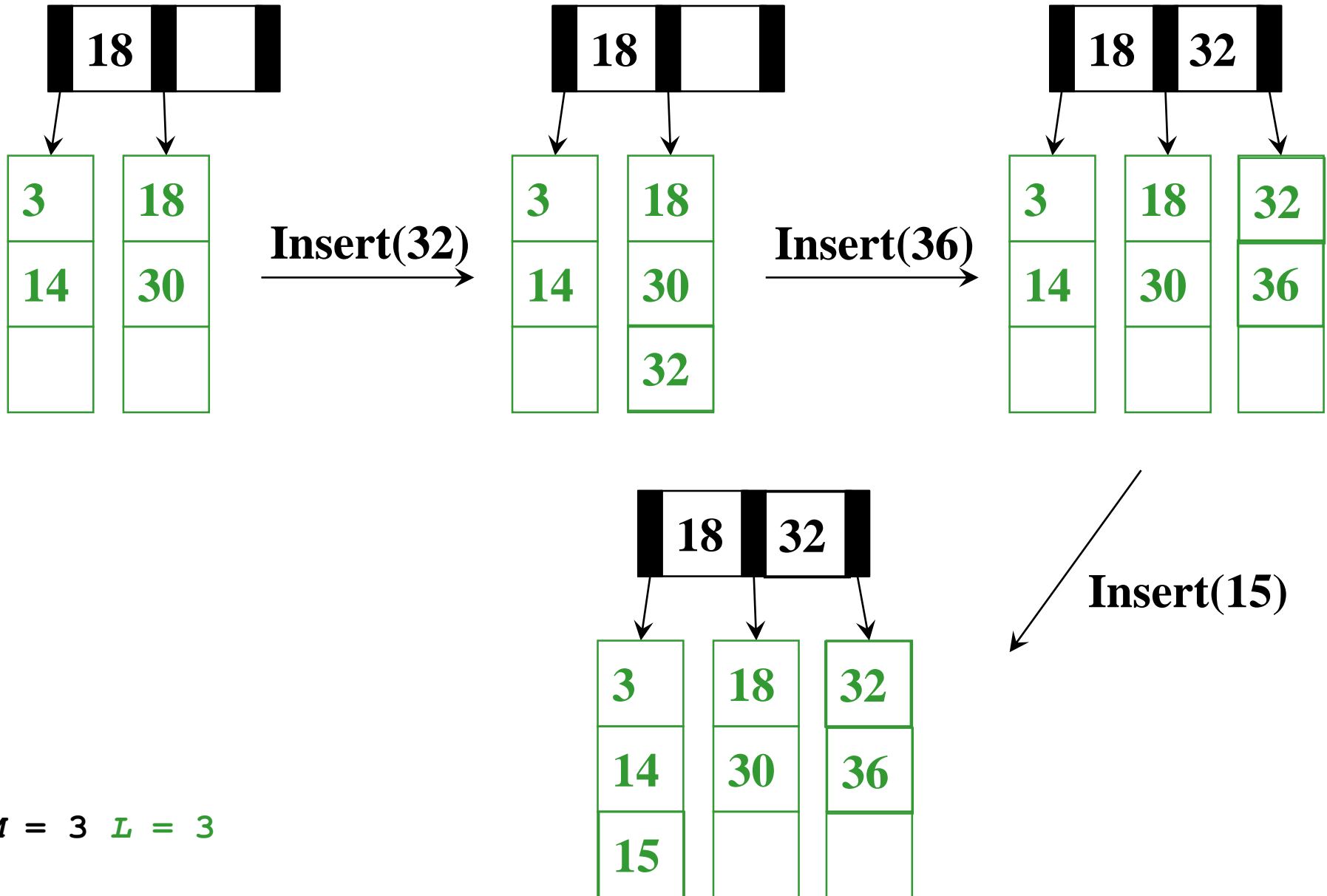

$$M = 3 \quad L = 3$$

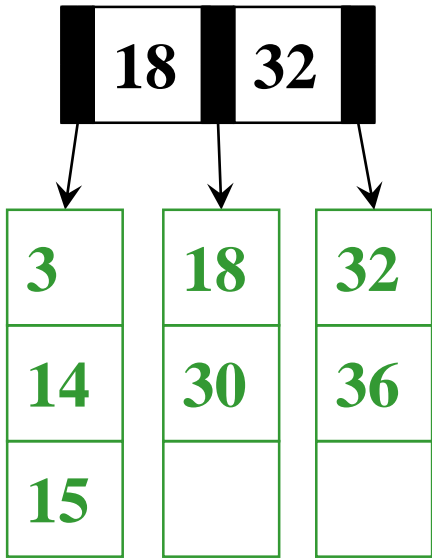

Insert(16) →

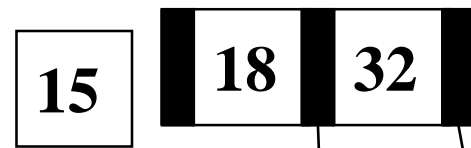
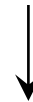
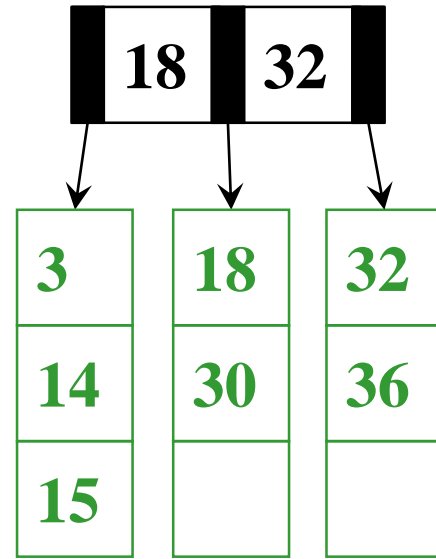

What now?

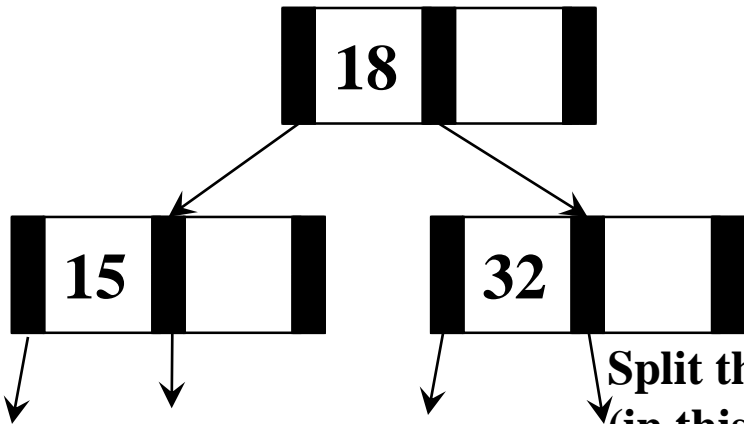

Split the internal node (in this case, the **root**)

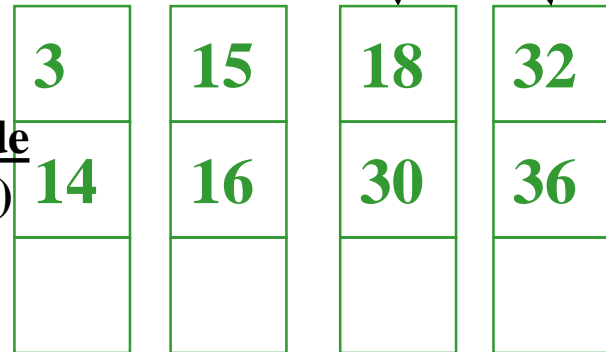



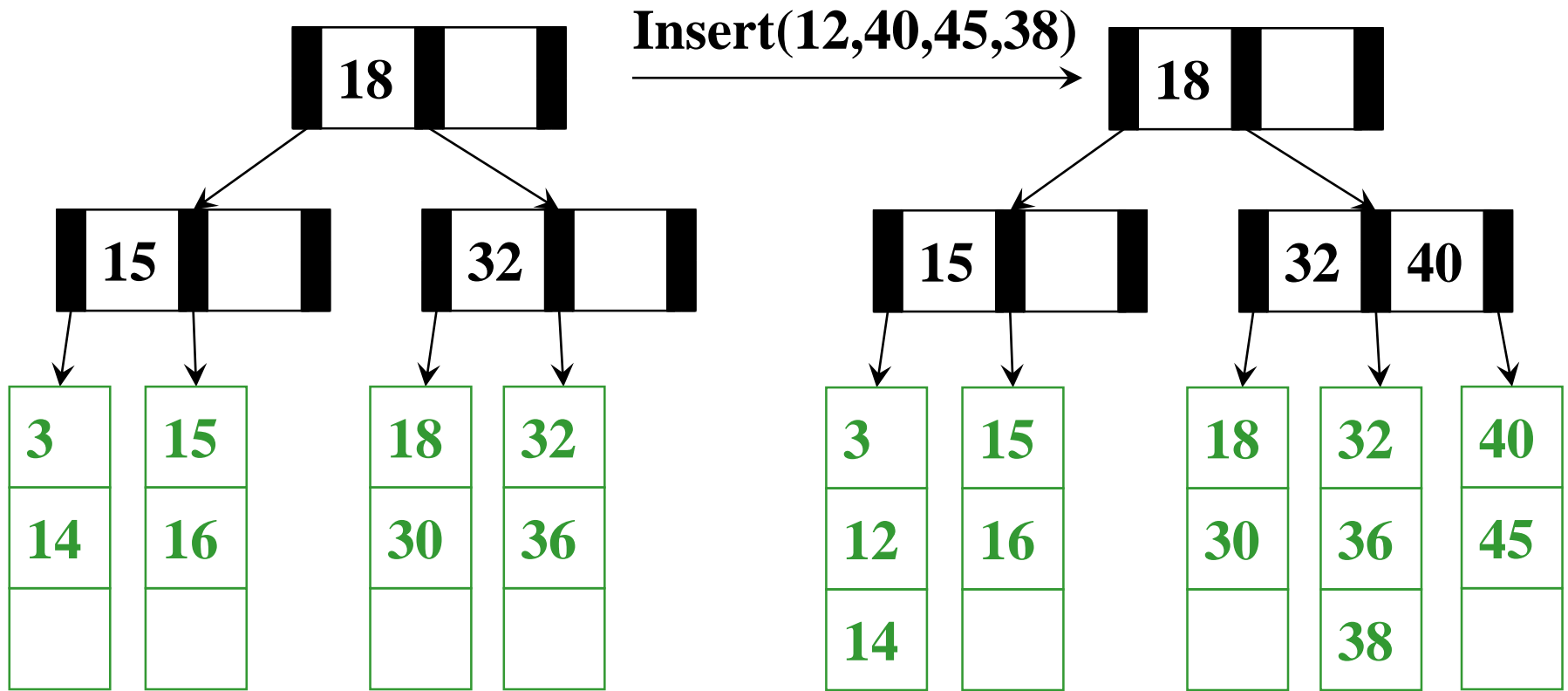

$$M = 3 \quad L = 3$$

**Note:** Given the **leaves** and the structure of the tree, we can always fill in internal node keys; ‘the smallest value in my right branch’

# *Insertion Algorithm*

1. Insert the data in its **leaf** in sorted order
  
2. If the **leaf** now has  $L+1$  items, *overflow!*
  - Split the **leaf** into two nodes:
    - Original **leaf** with  $\lceil (L+1) / 2 \rceil$  smaller items
    - New **leaf** with  $\lfloor (L+1) / 2 \rfloor = \lceil L/2 \rceil$  larger items
  - Attach the new child to the parent
    - Adding new key to parent in sorted order
  
3. If step (2) caused the parent to have  $M+1$  children, *overflow!*
  - ...

## *Insertion algorithm continued*

3. If an **internal node** has  $M+1$  children
  - Split the **node** into **two nodes**
    - Original **node** with  $\lceil (M+1) / 2 \rceil$  smaller items
    - New **node** with  $\lfloor (M+1) / 2 \rfloor = \lceil M/2 \rceil$  larger items
  - Attach the new child to the parent
    - Adding new key to parent in sorted order

Splitting at a node (step 3) could make the parent overflow too

- *So repeat step 3 up the tree until a node doesn't overflow*
- If the **root** overflows, make a new **root** with two children
  - This is the only case that increases the tree height

# *Efficiency of insert*

- Find correct leaf:  $O(\log_2 M \log_M n)$
- Insert in leaf:  $O(L)$
- Split leaf:  $O(L)$
- Split parents all the way up to root:  $O(M \log_M n)$

Total:  $O(L + M \log_M n)$

But it's not that bad:

- Splits are not that common (only required when a node is FULL, M and L are likely to be large, and after a split, will be half empty)
- Splitting the **root** is extremely rare
- Remember disk accesses were the name of the game:  
 $O(\log_M n)$

# *B-Tree Reminder: Another dictionary*

- Before we talk about deletion, just keep in mind overall idea:
  - Large data sets won't fit entirely in memory
  - Disk access is slow
  - Set up tree so we do one disk access per node in tree
  - Then our goal is to keep tree shallow as possible
  - Balanced binary tree is a good start, but we can do better than  $\log_2 n$  height
  - In an M-ary tree, height drops to  $\log_M n$ 
    - Why not set M really really high? Height 1 tree...
    - Instead, set M so that each node fits in a disk block

# And Now for Deletion...

Delete(32)

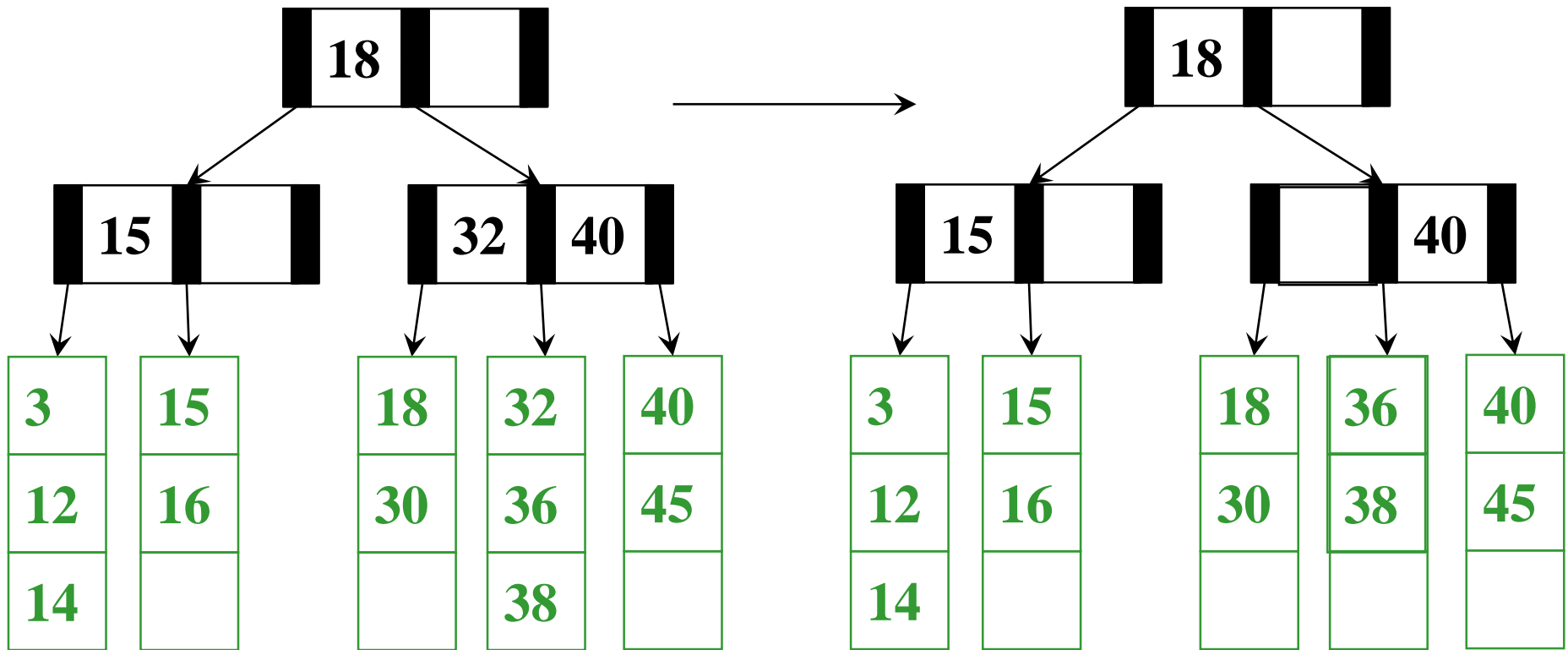

Easy case: Leaf still has enough data; just remove

$$M = 3 \quad L = 3$$

Delete(15)

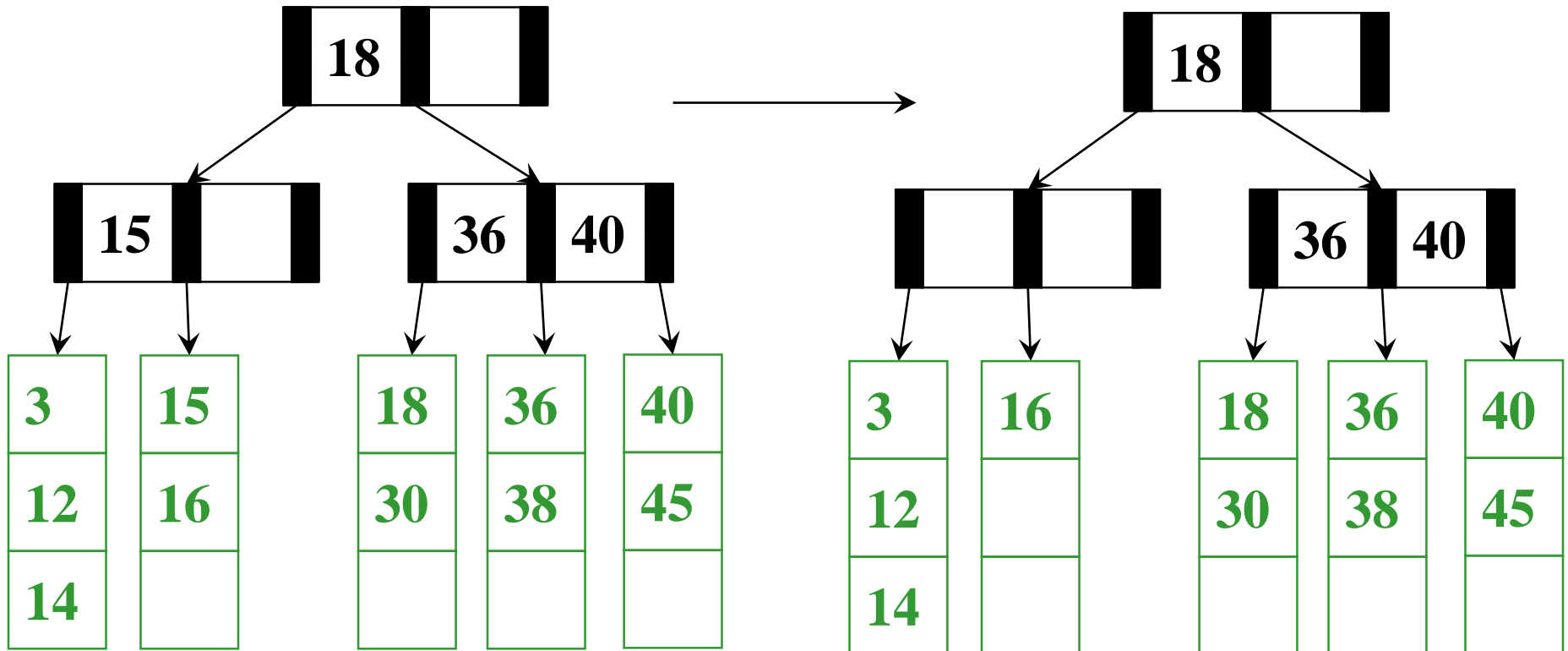

$M = 3$   $L = 3$

1/25/2021

Is there a problem?

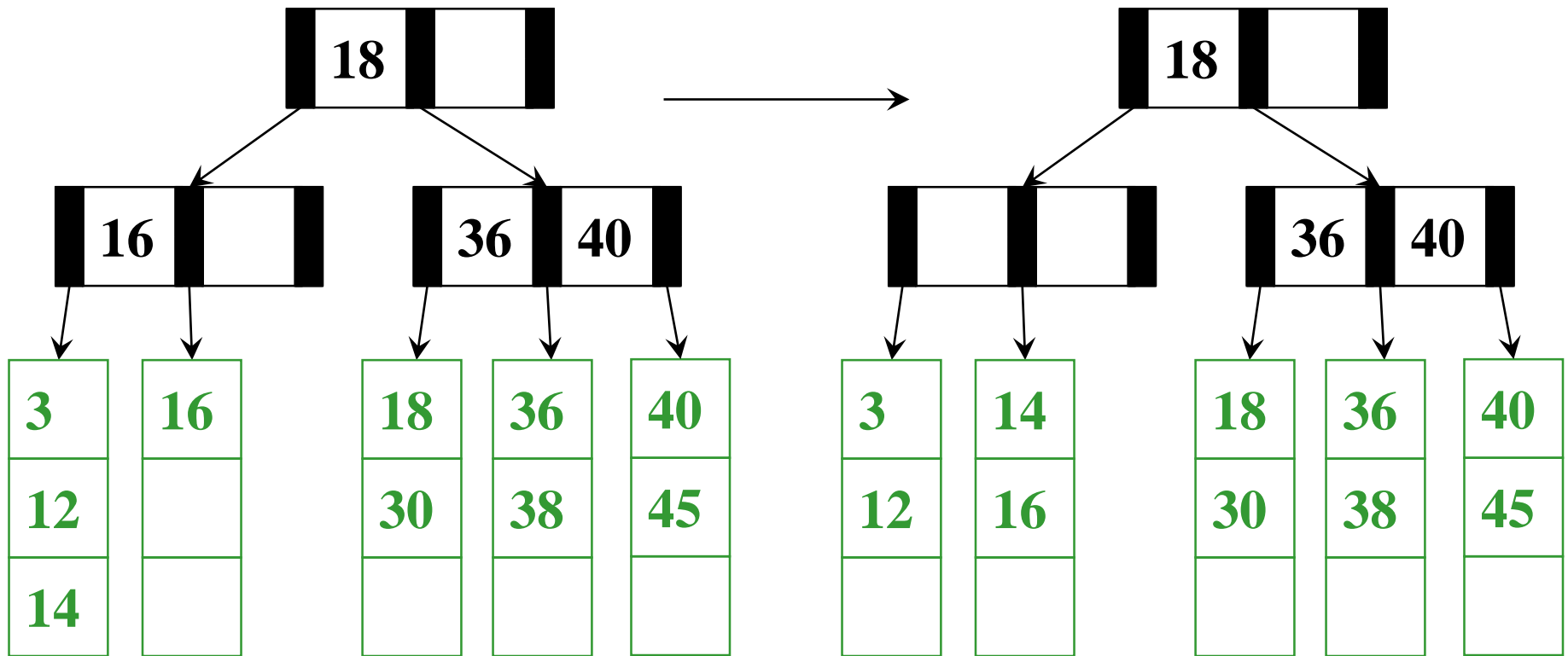

$M = 3$   $L = 3$

1/25/2021

Adopt from neighbor!



# Delete(16)

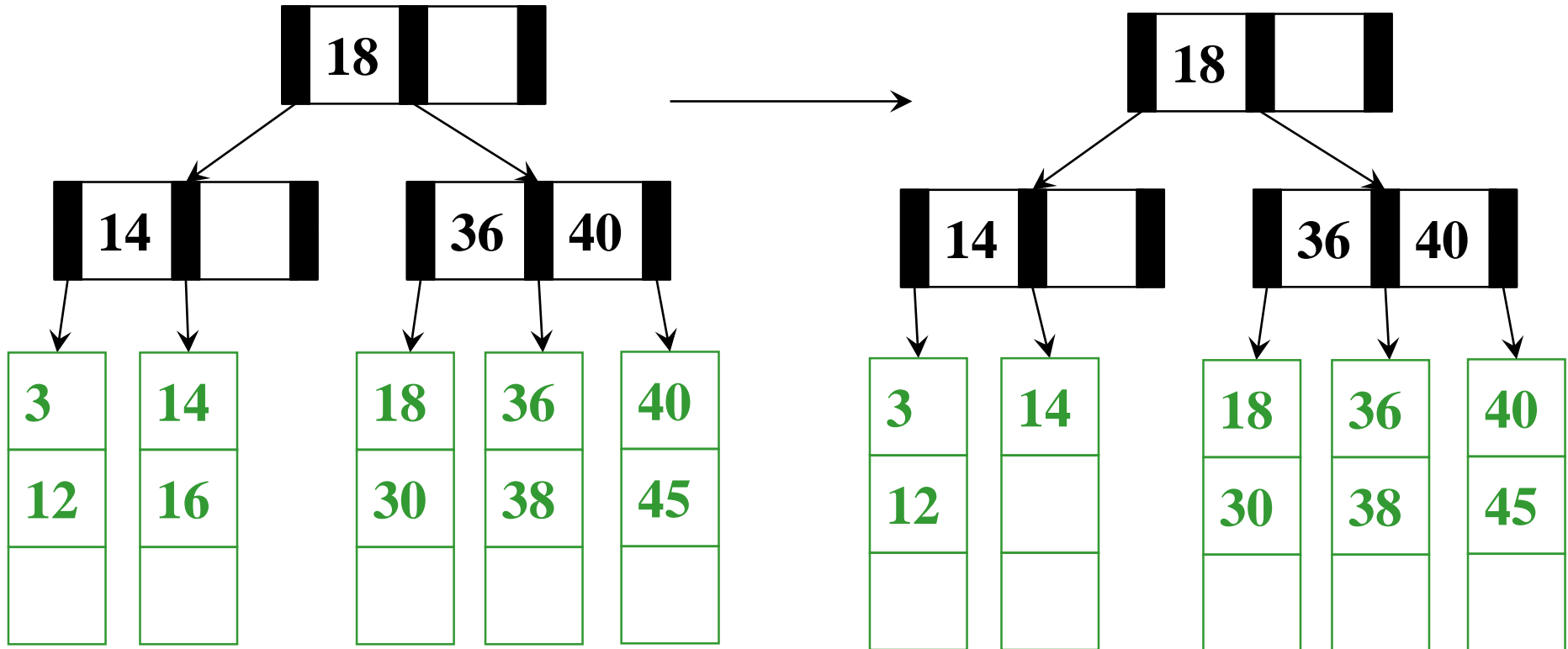

$M = 3$   $L = 3$

1/25/2021

Is there a problem?

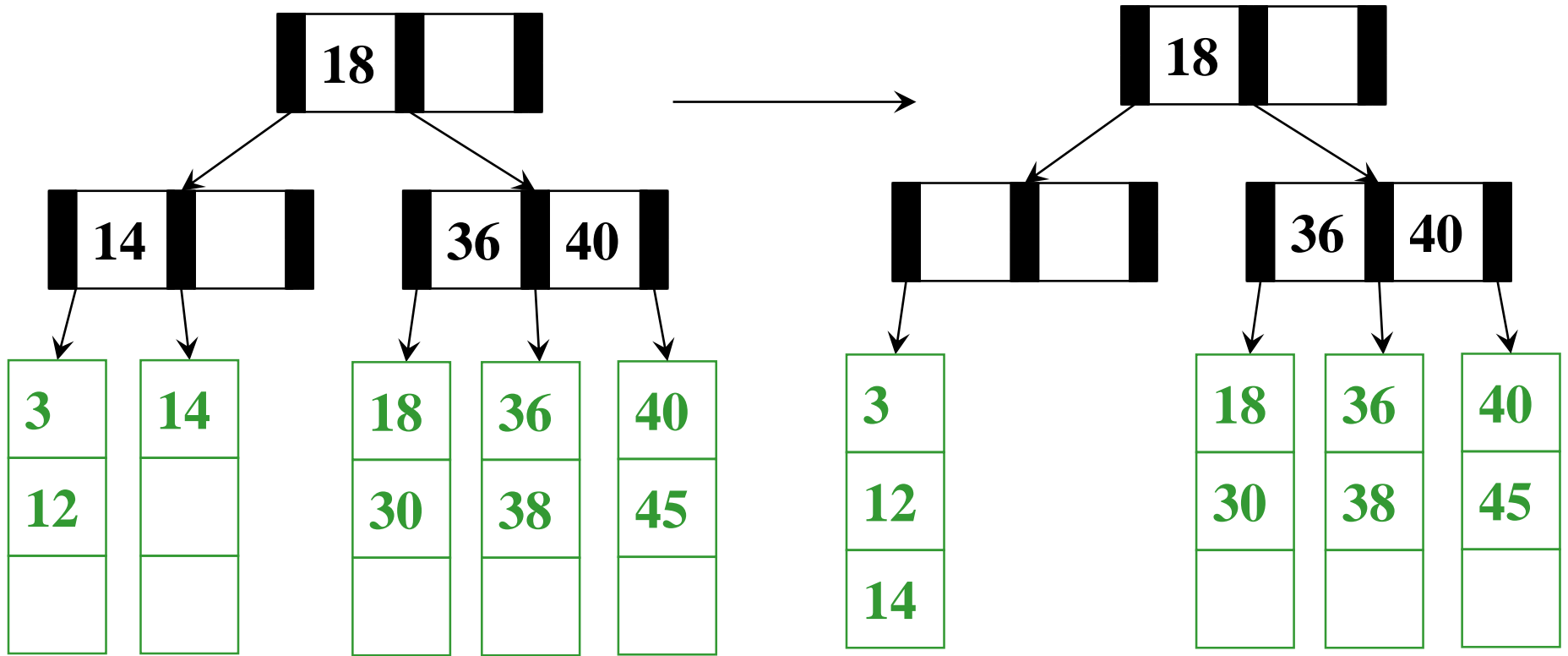

Merge with neighbor!

$M = 3$   $L = 3$

1/25/2021

But hey, Is there a problem?

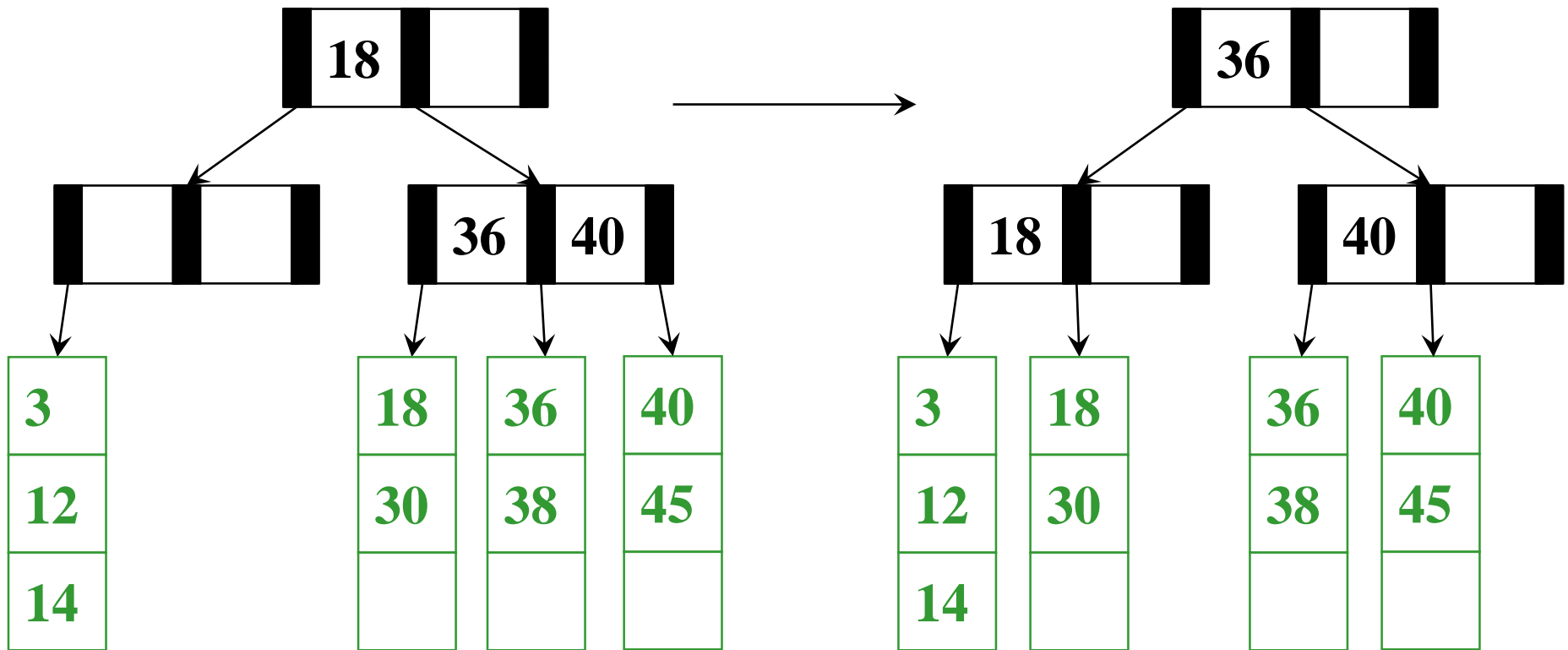

$M = 3$   $L = 3$

1/25/2021

Adopt from neighbor!

# Delete(14)

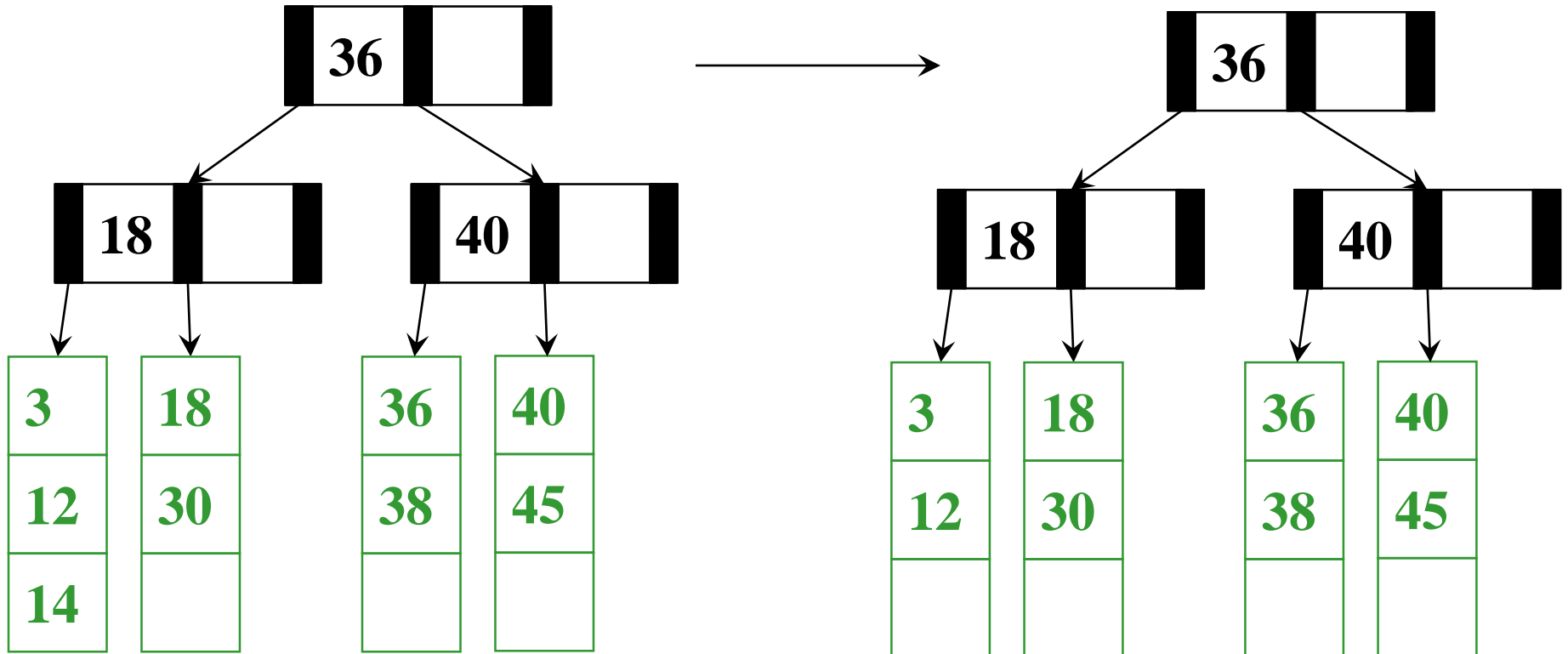

$M = 3$   $L = 3$

# Delete(18)

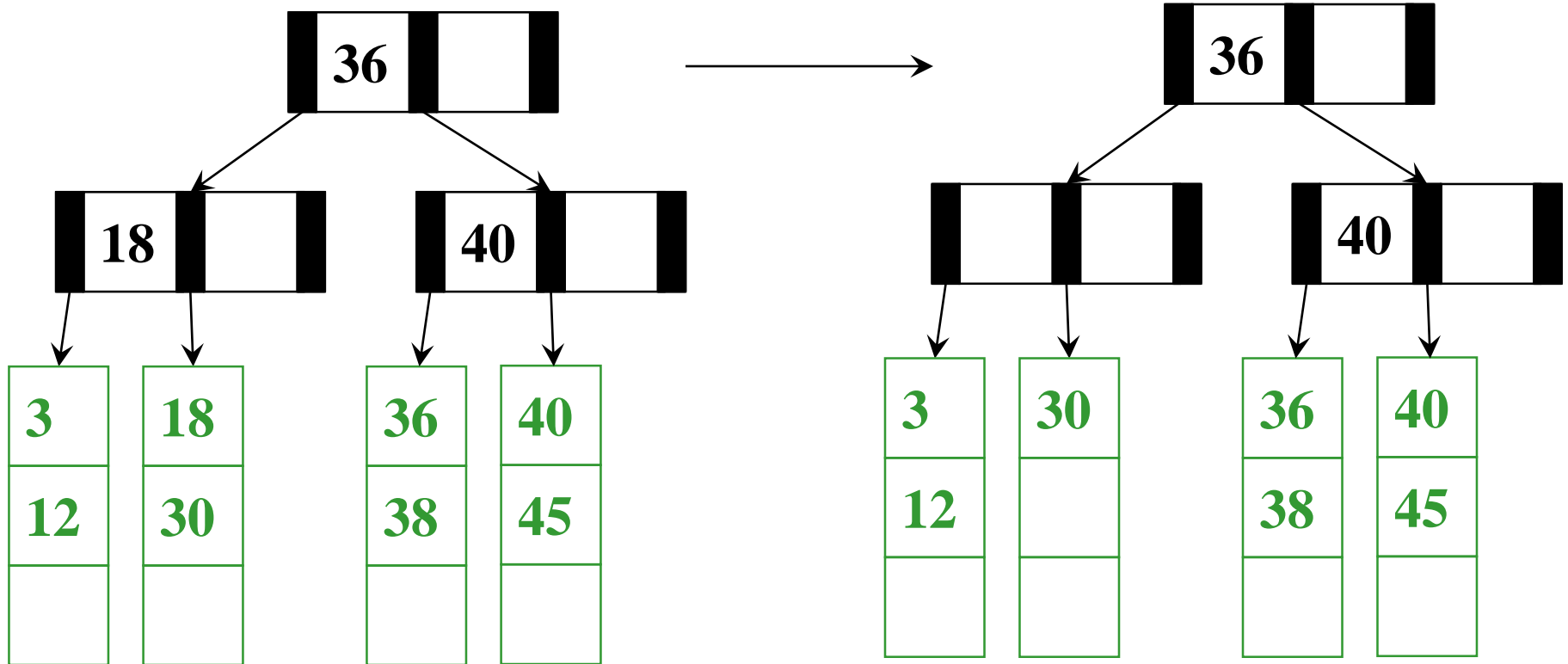

Is there a problem?

$M = 3$   $L = 3$

1/25/2021

45

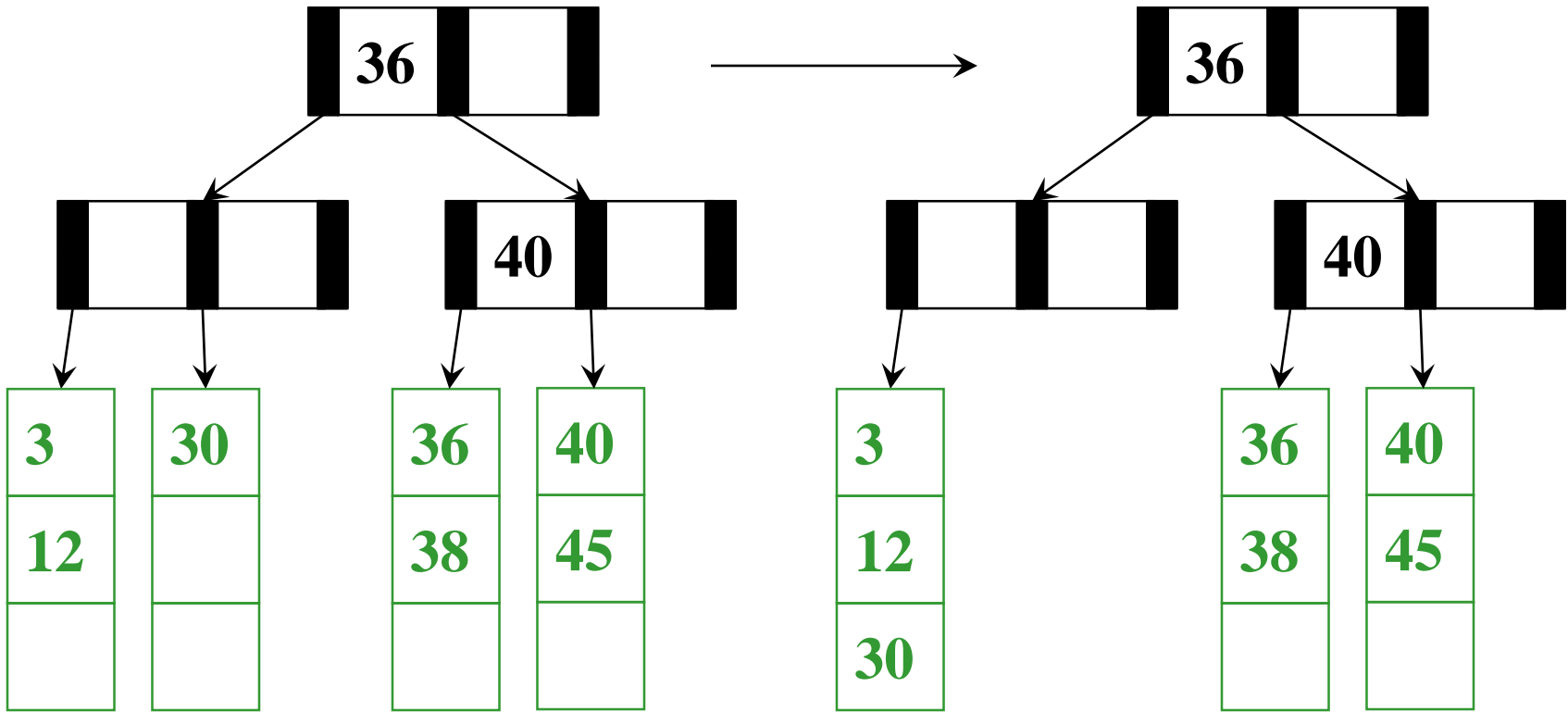

$M = 3$   $L = 3$

1/25/2021

Merge with neighbor!

But hey, Is there a problem?

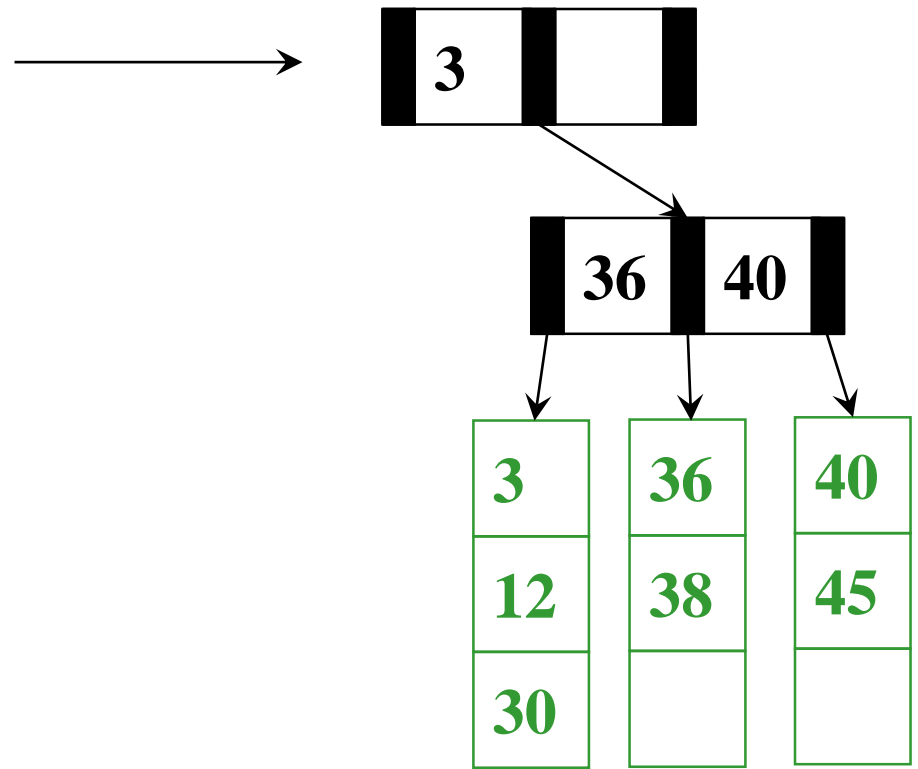
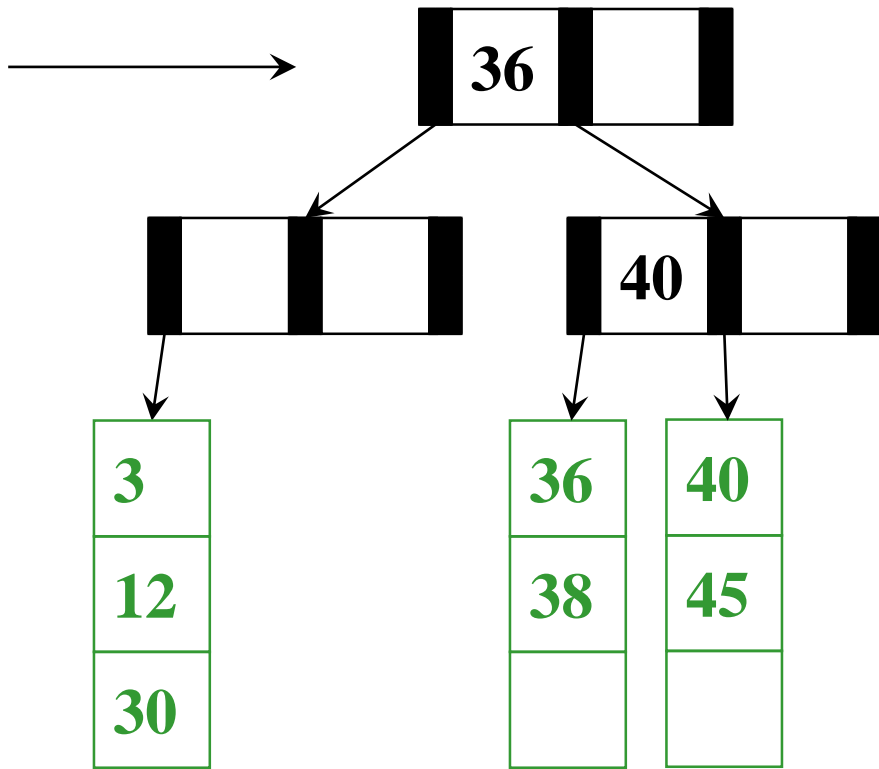

$M = 3$   $L = 3$

Merge with neighbor!

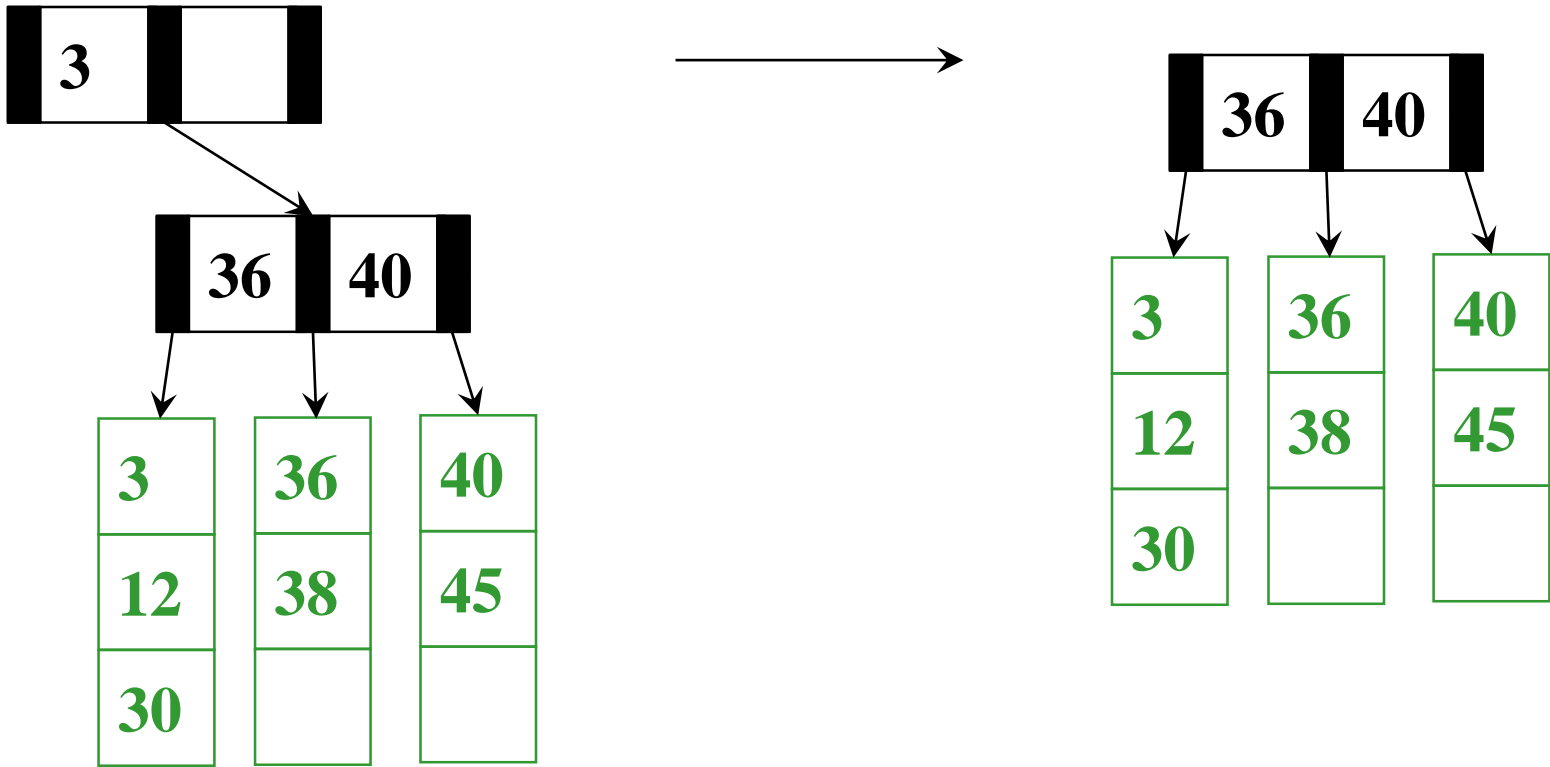

$M = 3$   $L = 3$

Pull out the root!



# *Deletion Algorithm, part 1*

1. Remove the data from its leaf
2. If the leaf now has  $\lceil L/2 \rceil - 1$ , *underflow!*
  - If a neighbor has  $> \lceil L/2 \rceil$  items, *adopt* and update parent
  - Else *merge* node with neighbor
    - Guaranteed to have a legal number of items
    - Parent now has one less node
3. If step (2) caused the parent to have  $\lceil M/2 \rceil - 1$  children, *underflow!*
  - ...

## *Deletion algorithm (continued)*

3. If an internal node has  $\lceil M/2 \rceil - 1$  children
  - If a neighbor has  $> \lceil M/2 \rceil$  items, *adopt* and update parent
  - Else *merge* node with neighbor
    - Guaranteed to have a legal number of items
    - Parent now has one less node, may need to continue up the tree

If we merge all the way up through the root, that's fine unless the root went from 2 children to 1

- In that case, delete the root and make child the root
- This is the only case that decreases tree height

# *Worst-Case Efficiency of Delete*

- Find correct leaf:  $O(\log_2 M \log_M n)$
- Remove from leaf:  $O(L)$
- Adopt from or merge with neighbor:  $O(L)$
- Adopt or merge all the way up to root:  $O(M \log_M n)$

Total:  $O(L + M \log_M n)$

But it's not that bad:

- Merges are not that common
- Disk accesses are the name of the game:  $O(\log_M n)$

# *Insert vs delete comparison*

## Insert

- Find correct leaf:  $O(\log_2 M \log_M n)$
- Insert in leaf:  $O(L)$
- Split leaf:  $O(L)$
- Split parents all the way up to root:  $O(M \log_M n)$

## Delete

- Find correct leaf:  $O(\log_2 M \log_M n)$
- Remove from leaf:  $O(L)$
- Adopt/merge from/with neighbor leaf:  $O(L)$
- Adopt or merge all the way up to root:  $O(M \log_M n)$

# *B Trees in Java?*

For most of our data structures, we have encouraged writing high-level, reusable code, such as in Java with generics

It is worthwhile to know enough about “how Java works” to understand why this is probably a bad idea for B trees

- If you just want a balanced tree with worst-case logarithmic operations, no problem
  - If  $M=3$ , this is called a 2-3 tree
  - If  $M=4$ , this is called a 2-3-4 tree
- Assuming our goal is efficient number of disk accesses
  - Java has many advantages, but it wasn't designed for this

The key issue is extra *levels of indirection...*

# Naïve approach in Java

Even if we assume data items have `int` keys, you cannot get the data representation you want for “really big data”

```
interface Keyed {
    int getKey();
}
class BTreeNode<E implements Keyed> {
    static final int M = 128;
    int[] keys = new int[M-1];
    BTreeNode<E>[] children = new BTreeNode[M];
    int numChildren = 0;
    ...
}
class BTreeLeaf<E implements Keyed> {
    static final int L = 32;
    E[] data = (E[])new Object[L];
    int numItems = 0;
    ...
}
```

All the **red** references indicate “unnecessary” indirection that might be avoided in another programming language.

# What that looks like in Java

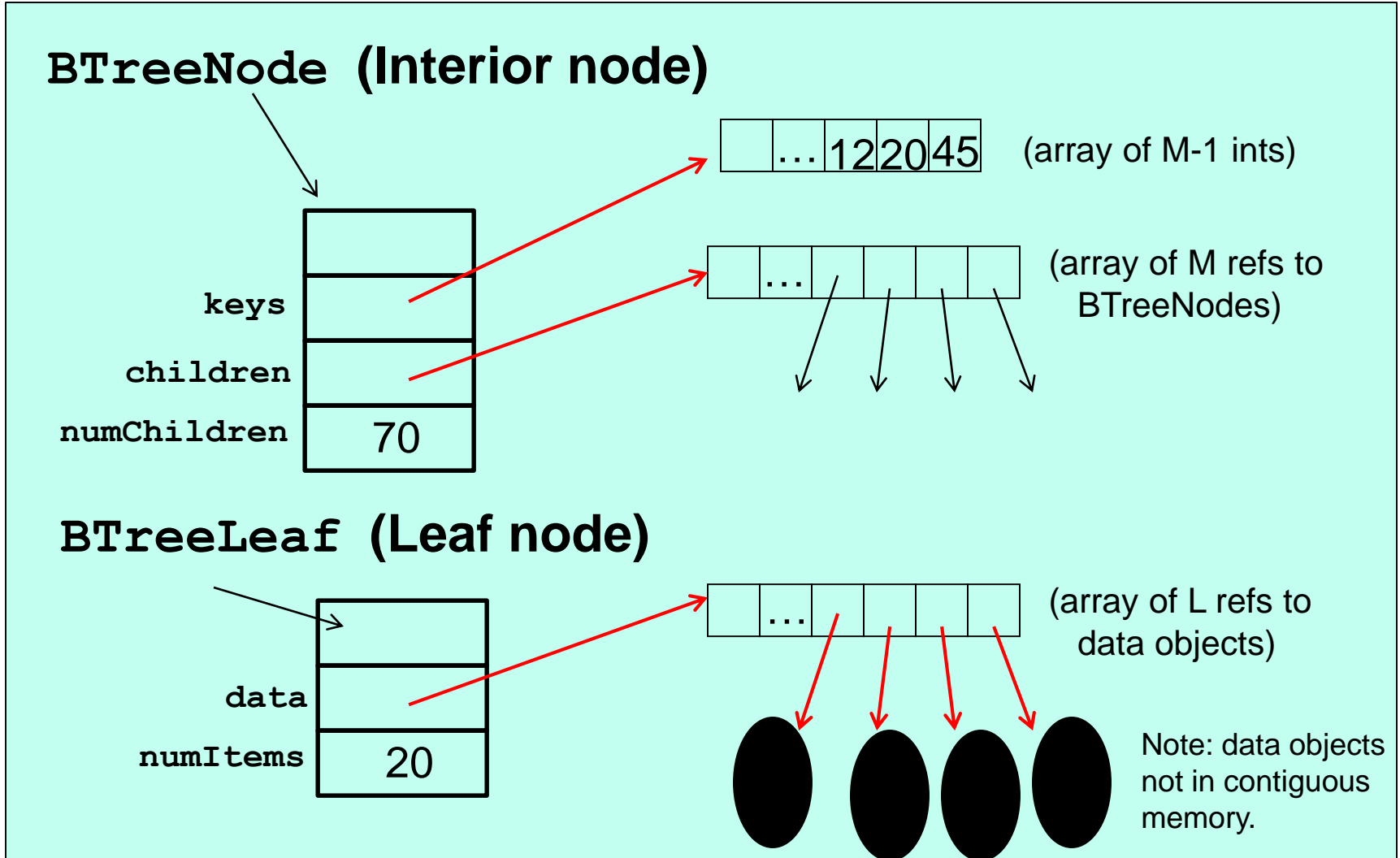

# *The moral*

- The whole idea behind B trees was to keep related data in contiguous memory
- But that's "the best you can do" in Java
  - Again, the advantage is generic, reusable code
  - But for your performance-critical web-index, not the way to implement your B-Tree for terabytes of data
- Other languages (e.g., C++) have better support for "flattening objects into arrays"
- Levels of indirection matter!



# *Conclusion: Balanced Trees*

- *Balanced* trees make good dictionaries because they guarantee logarithmic-time **find**, **insert**, and **delete**
  - Essential and beautiful computer science
  - But only if you can maintain balance within the time bound
- **AVL trees** maintain balance by tracking height and allowing all children to differ in height by at most 1
- **B trees** maintain balance by keeping nodes at least half full and all leaves at same height
- Other great balanced trees (see text; worth knowing they exist)
  - **Red-black trees**: all leaves have depth within a factor of 2
  - **Splay trees**: self-adjusting; amortized guarantee; no extra space for height information