

Warm Up

p	q	r	$F(p, q, r)$
T	T	T	T
T	T	F	T
T	F	T	F
T	F	F	T
F	T	T	T
F	T	F	F
F	F	T	F
F	F	F	T

1. Write a propositional logic expression for F in DNF (ORs of ANDs) form
2. Write a propositional logic expression for F in CNF (ANDs of ORs) form

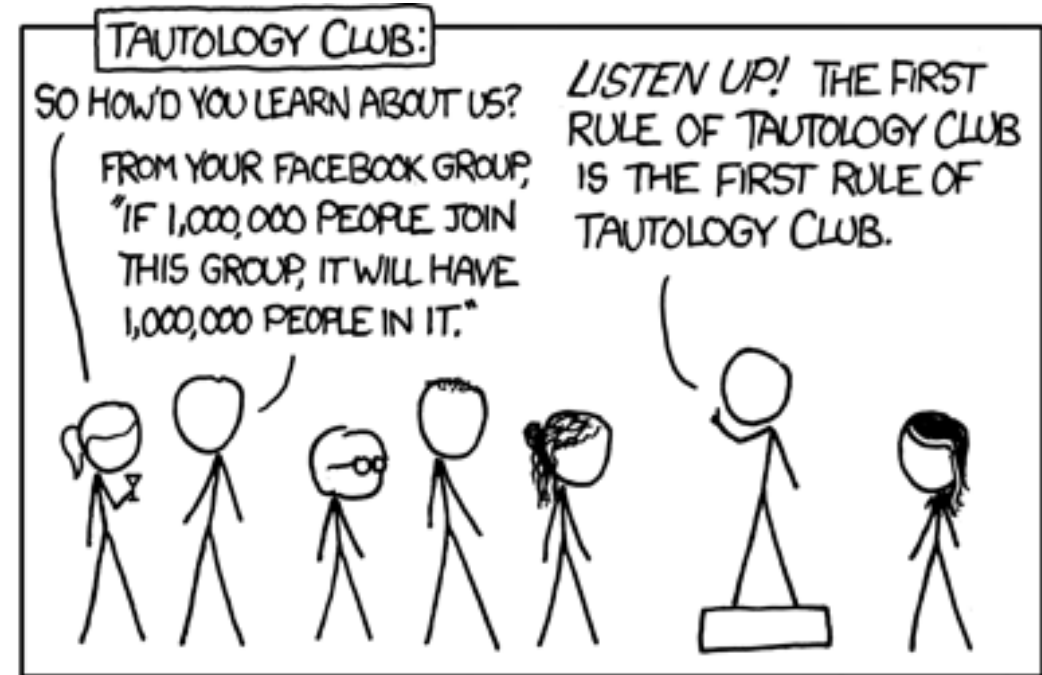

Predicate Logic

CSE 311: Foundations of
Computing I
Lecture 4

Announcements

- HW1
 - Due tonight, 11:59 pm
- HW2
 - Released tonight

Warm Up

p	q	r	$F(p, q, r)$
T	T	T	T
T	T	F	T
T	F	T	F
T	F	F	T
F	T	T	T
F	T	F	F
F	F	T	F
F	F	F	T

1. Write a propositional logic expression for F in DNF (ORs of ANDs) form
2. Write a propositional logic expression for F in CNF (ANDs of ORs) form

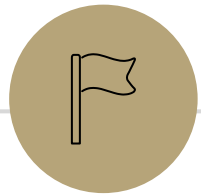

Boolean Algebra & Circuits

Notation

- Logic is fundamental
 - Computer scientists use it in programs
 - Mathematicians use it in proofs
 - Engineers use it in hardware
 - Philosophers use it in arguments
- Consequently, everyone has their own notation

Boolean Algebra

Another notation for logic. Preferred by some because it's compact.

Term	Propositional Logic	Boolean Algebra
or	\vee	$+$
and	\wedge	\cdot
not	\neg	$'$
True	T	1
False	F	0

$(p \wedge q \wedge r) \vee s \vee \neg t$ in Boolean Algebra is _____.

Digital Circuits

Computing with Logic

- T corresponds to 1, or high voltage
- F corresponds to 0, or low voltage

Gates

- Gates take inputs and produce outputs

Digital Circuits – Gates

AND Gate

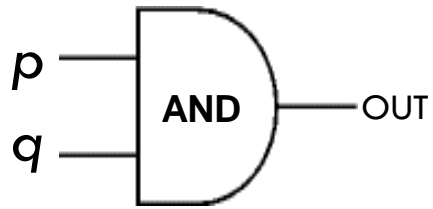

OR Gate

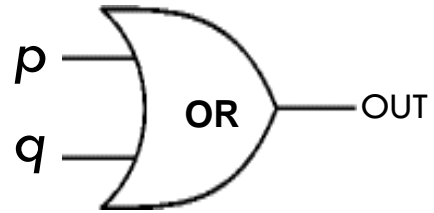

NOT Gate

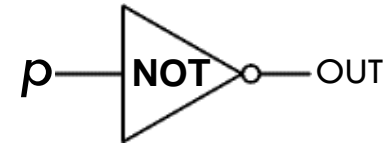

Digital Circuits – Example

Write $\neg p \wedge (\neg q \wedge (r \vee s))$ as a circuit.

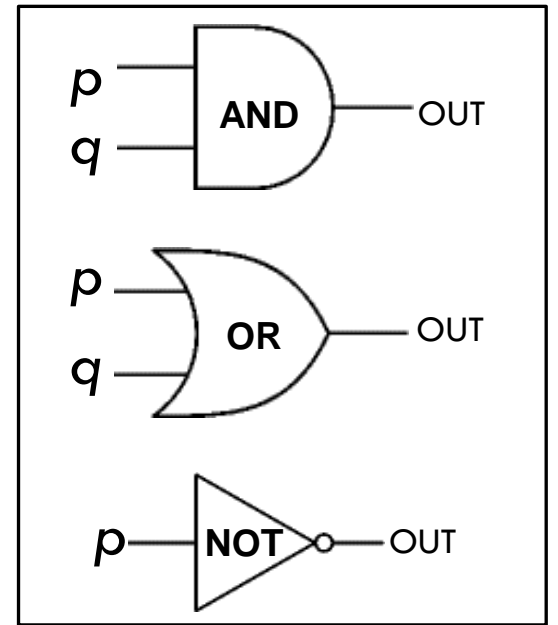

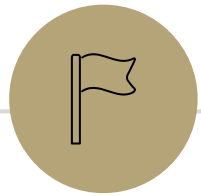

Predicate Logic



Motivation

Often we will work with statements of the form:

If $x > 10$, then $x^2 > 100$.

If x is even, x^2 is even.

Can you translate these to propositional logic?

Motivation

Propositional Logic

Lets us break down complex true or false statements into atomic parts joined by connectives.

Predicate Logic

Lets us analyze complex true or false statements that are functions of some underlying objects.

Predicate Logic

3 Parts

1. Predicate
2. Domain of Discourse
3. Quantifiers

Predicate

Definition:

A **predicate** is a _____.

$\text{Cat}(x) := x$ is a cat

$\text{Even}(x) := x$ is even

$\text{LessThan}(x, y) := x < y$

$\text{Sum}(x, y, z) := x + y = z$

$\text{IsRaining} :=$ It is raining outside

Analogy

Propositions were like Boolean variables.

```
boolean itIsRaining = true
```

Predicates are like functions that return Boolean values.

```
public boolean Even(int x) {...}
```

Predicate Translation: Example

x is prime or x^2 is odd, or $x = 2$

Domain of Discourse

Definition:

The **domain of discourse** for a predicate is _____.

$\text{Cat}(x)$ – Possible domains include _____, _____, _____.

$\text{LessThan}(x, y)$ – Possible domains include _____, _____.

Domain of Discourse: Example

What's a possible domain of discourse for these predicates?

1. $\text{Prime}(x) := x$ is prime
2. $\text{Equals}(x, y) := x$ and y are the same object
3. $\text{EnrolledIn}(x, y) := x$ is enrolled in course y

Quantifiers: Motivation

We tend to use variables for two reasons:

1. The statement is true for every x .
For every integer x , if x is even then x^2 is even.
2. There is some x for which the statement is true.
There is some problem x that computers cannot solve.

Quantifiers

$\forall x P(x)$

- \forall is called the _____.
- Read out loud as _____.
- $\forall x P(x)$ means _____.

$\exists x P(x)$

- \exists is called the _____.
- Read out loud as _____.
- $\exists x P(x)$ means _____.

Predicate Logic Summary

3 Parts

1. Predicate – Function that outputs true or false.
2. Domain of Discourse – Set of possible inputs to a predicate.
3. Quantifiers – A statement about when a predicate is true: \forall or \exists

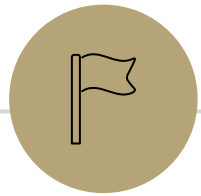

Predicate Logic Translation

English to Logic

Domain of Discourse
Integers

Predicate Definitions
Even(x) := x is even
Equals(x, y) := $x = y$
LessThan(x, y) := $x < y$

Translate to predicate logic. Then evaluate if the statement is **T** or **F**.

For every integer x , if x is even, then $x = 2$.

There are integers x and y such that $x < y$.

Logic to English

Domain of Discourse
Integers

Predicate Definitions
Even(x) := x is even
LessThan(x, y) := $x < y$
Odd(x) := x is odd

Translate to English. Then evaluate if the statement is T or F.

$$\exists x(\text{Odd}(x) \wedge \text{LessThan}(x, 5))$$

$$\forall y(\text{Even}(y) \wedge \text{Odd}(y))$$

Examples

Domain of Discourse

Integers

Predicate Definitions

Even(x) := x is even Greater(x, y) := $x > y$

Odd(x) := x is odd Prime(x) := x is prime

Translate to English. Then evaluate if the statement is T or F.

$\exists x \text{ Even}(x)$

$\forall x \text{ Odd}(x)$

$\forall x (\text{Even}(x) \vee \text{Odd}(x))$

$\exists x (\text{Even}(x) \wedge \text{Odd}(x))$

$\forall x \text{ Greater}(x + 1, x)$

$\exists x (\text{Even}(x) \wedge \text{Prime}(x))$

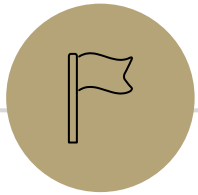

Domain Restriction

Domain Restriction

Definition:

Domain restriction is _____.

Domain Restriction

Domain of Discourse
Animals

Predicate Definitions
 $\text{Cat}(x) := x$ is a cat
 $\text{Blue}(x) := x$ is blue

All cats are blue.

There is a blue cat.

Domain Restriction

Domain of Discourse
Animals

Predicate Definitions
Cat(x) := x is a cat
Blue(x) := x is blue

$\forall x(\text{Cat}(x) \rightarrow \text{Blue}(x))$

vs.

$\forall x(\text{Cat}(x) \wedge \text{Blue}(x))$

$\exists x(\text{Cat}(x) \rightarrow \text{Blue}(x))$

vs.

$\exists x(\text{Cat}(x) \wedge \text{Blue}(x))$

Tip: Avoid \rightarrow under \exists in most situations

\forall and vacuous truth

$\forall x(\text{Cat}(x) \rightarrow \text{Blue}(x))$ means "all cats are blue".

One way to check if $\forall x P(x)$ is true is to "loop" over every element of the domain and check that $P(x)$ is true.

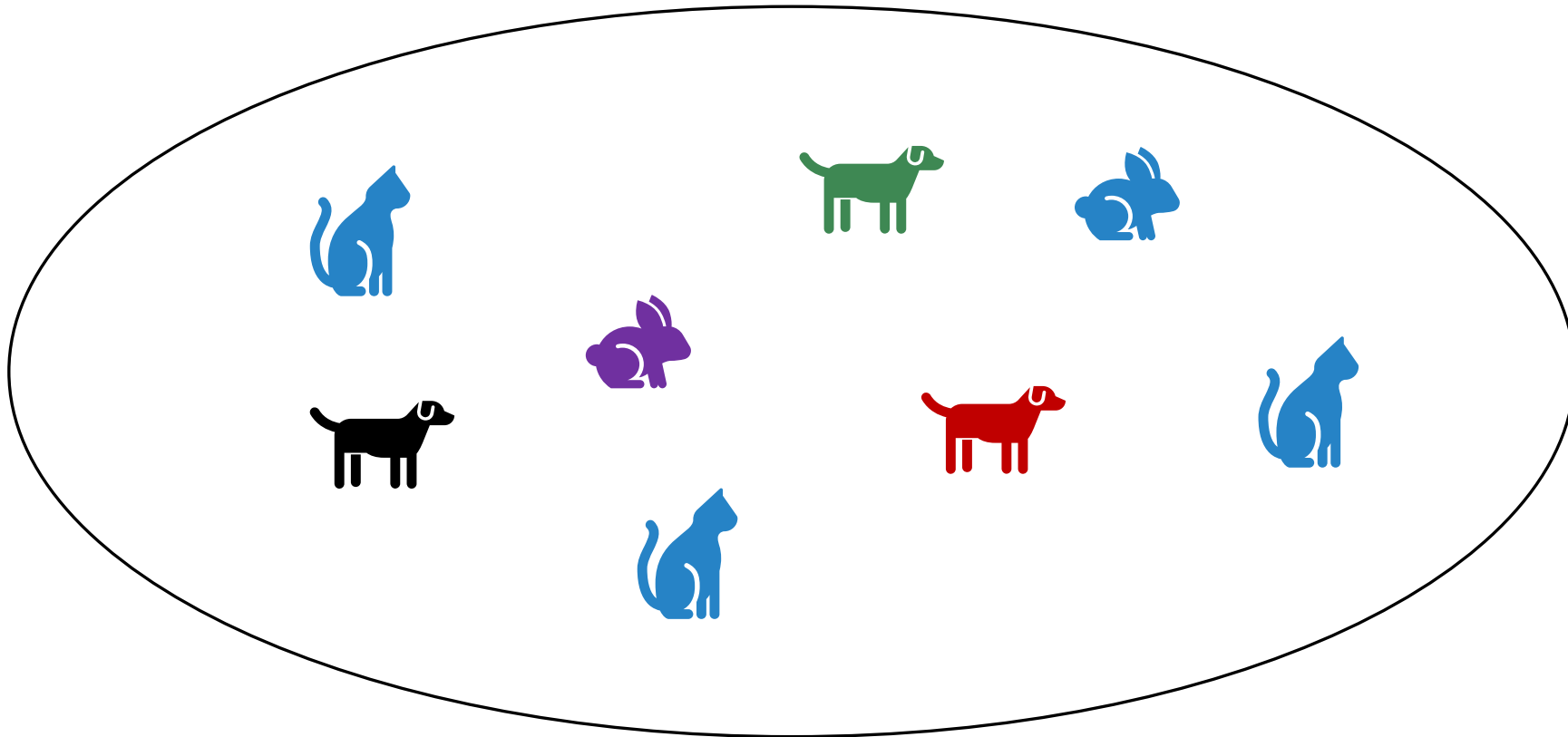

Domain Restriction

Translations often sound more **natural** if we:

1. Notice domain restriction patterns.
2. Avoid using variables when we can.
3. Drop the “for all” or “there exists” when we can.

For example:

$$\forall x(\text{Cat}(x) \rightarrow \text{Blue}(x))$$

✗ For all animals x , if x is a cat then x is blue.

✓ All cats are blue.

Domain Restriction

Domain of Discourse
Food

Predicate Definitions
Fruit(x) := x is a fruit
Tasty(x) := x is tasty
Ripe(x) := x is ripe

Translate these sentences using a **natural-sounding** translation.

$$\exists x(\text{Fruit}(x) \wedge \text{Tasty}(x))$$

$$\forall x \left((\text{Fruit}(x) \wedge \neg \text{Ripe}(x)) \rightarrow \neg \text{Tasty}(x) \right)$$

Quantifier Scope

$$\exists x (P(x) \wedge Q(x))$$

vs.

$$\exists x P(x) \wedge \exists x Q(x)$$

Section Tomorrow

Practice with equivalences & translating

Quantifiers can be nested!

There is a person that all people love.

$\exists x \forall y (\text{Love}(y, x))$