

Regular Languages

CSE 311 Winter 2022
Lecture 25

Announcements

HW8 is a mix of relations, DFAs/NFAs, and some review-y questions.
Due Wednesday

Final review materials and logistics on [this page](#).

What's fair game for the final?

Everything through the end of this slide deck can show up in any way. (cumulative)

Monday you'll learn how to show a language is "not regular." Wednesday you'll learn how to show a set is "uncountable." There will be a problem on the final "choose one of these two: show a language is irregular; show a set is uncountable"

Last day of class will wrap those topics/talk about the Halting Problem (won't be tested directly)

Let's try to make our more powerful automata

We're going to get rid of some of the restrictions on DFAs, to see if we can get more powerful machines (i.e. can recognize more languages).

From a given state, we'll allow any number of outgoing edges labeled with a given character. The machine can follow any of them.

We'll have edges labeled with " ϵ " – the machine (optionally) can follow one of those without reading another character from the input.

If we "get stuck" i.e. the next character is a and there's no transition leaving our state labeled a , the computation dies.

Nondeterministic Finite Automata

An NFA:

Still has exactly one start state and any number of final states.

The NFA accepts x if there is some path from a start state to a final state labeled with x .

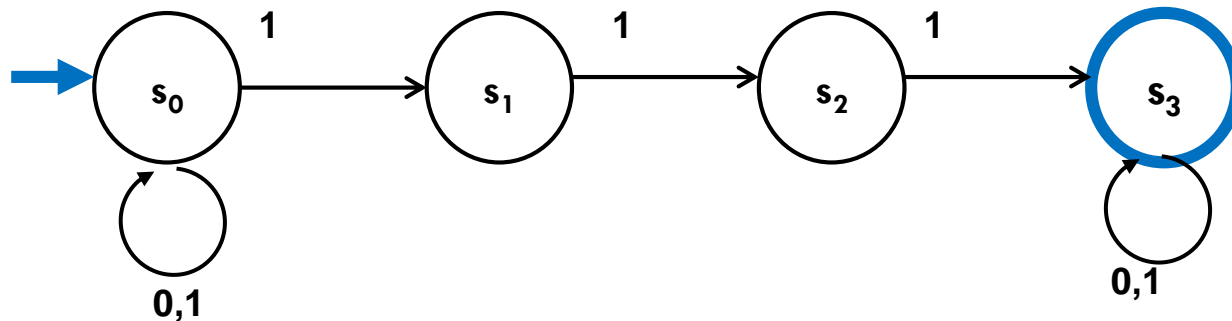

Wait a second...

But...how does it know?

Is this realistic?

Three ways to think about NFAs

“Outside Observer”: is there a path labeled by x from the start state, to the final state (if we know the input in advance can we tell the NFA which decisions to make)

“Perfect Guesser”: The NFA has input x , and whenever there is a choice of what to do, it **magically** guesses a transition that will eventually lead to acceptance (if one exists)

“Parallel exploration”: The NFA computation runs all possible computations on x in parallel (updating each possible one at every step)

So...magic guessing doesn't exist

I know.

The parallel computation view is realistic.

Lets us give simpler descriptions of complicated objects.

This notion of "nondeterminism" is also really useful in more advanced CS theory (you'll see it again in 421 or 431 if not sooner).

Source of the P vs. NP problem.

NFA practice

What is the language of this NFA?

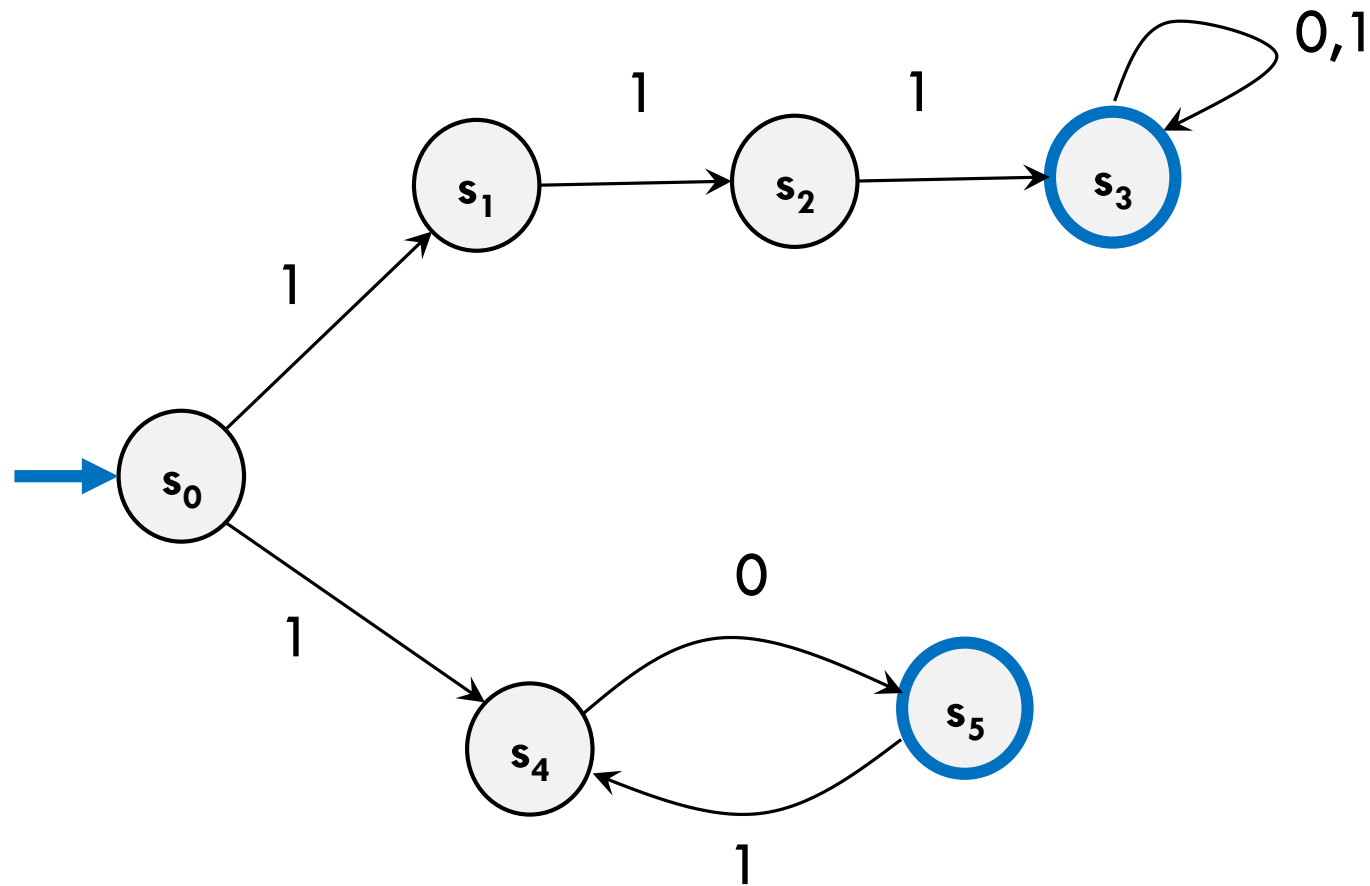

NFA practice

What is the language of this NFA?

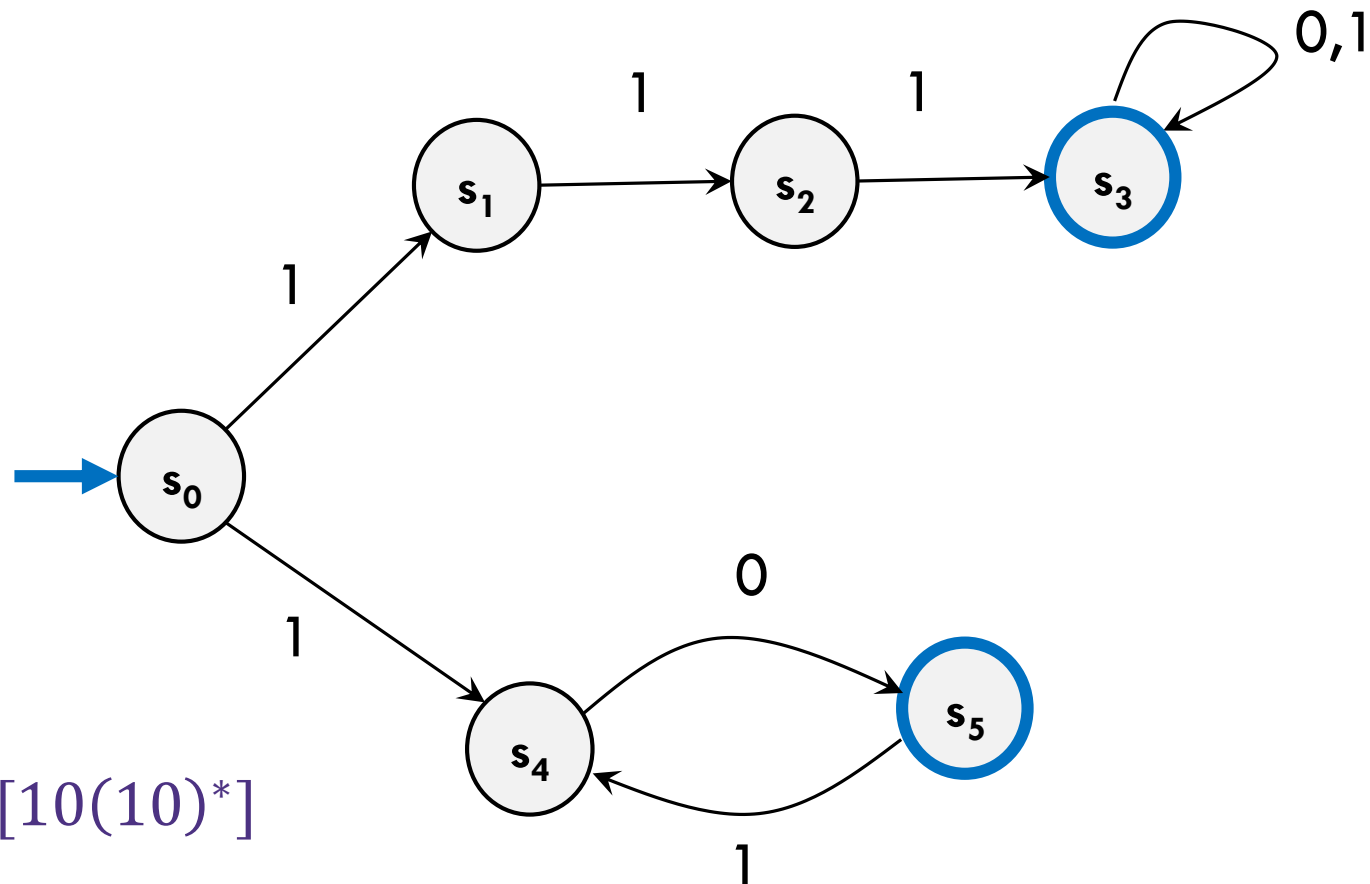

$111(0 \cup 1)^*$

$10(10)^*$

Overall
 $[111(0 \cup 1)^*] \cup [10(10)^*]$

What about those ε -transitions?

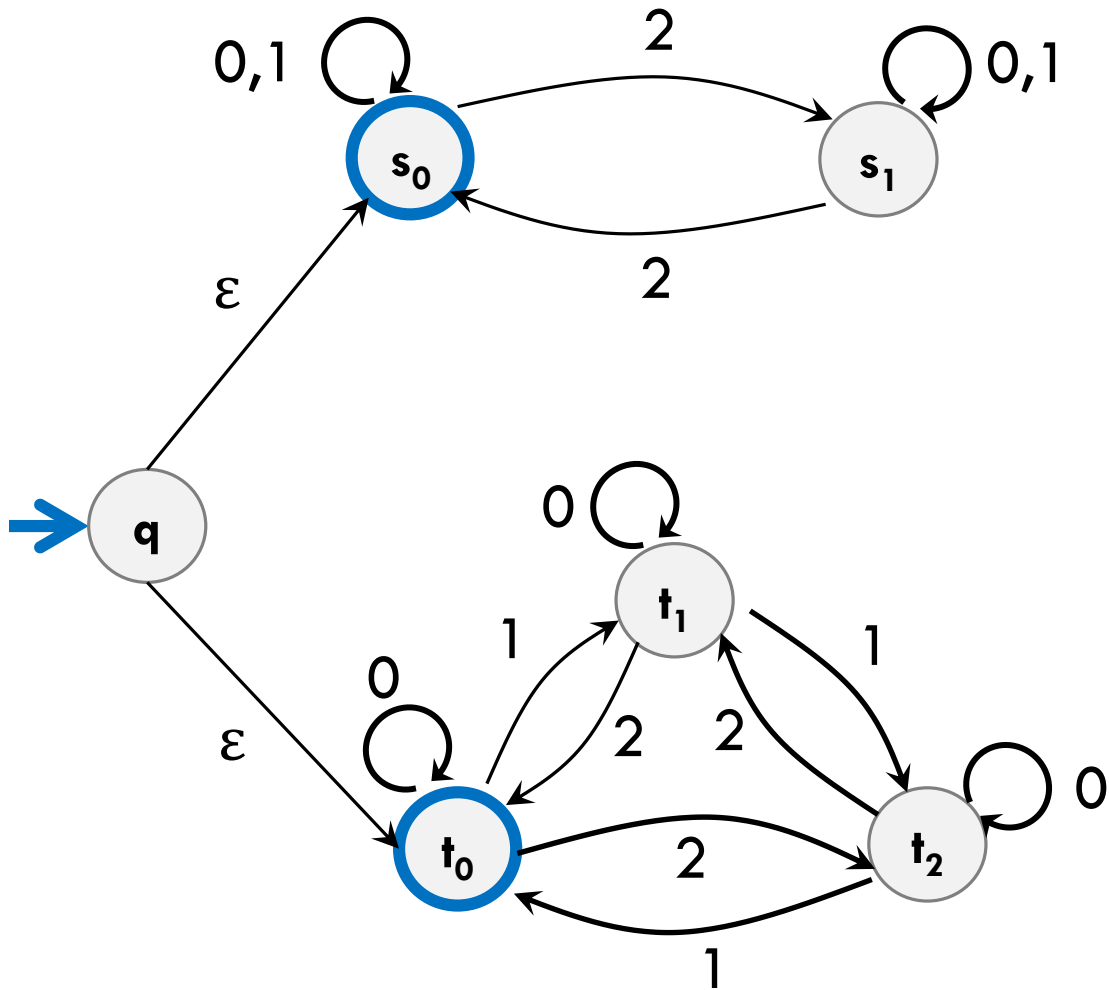

What about those ε -transitions?

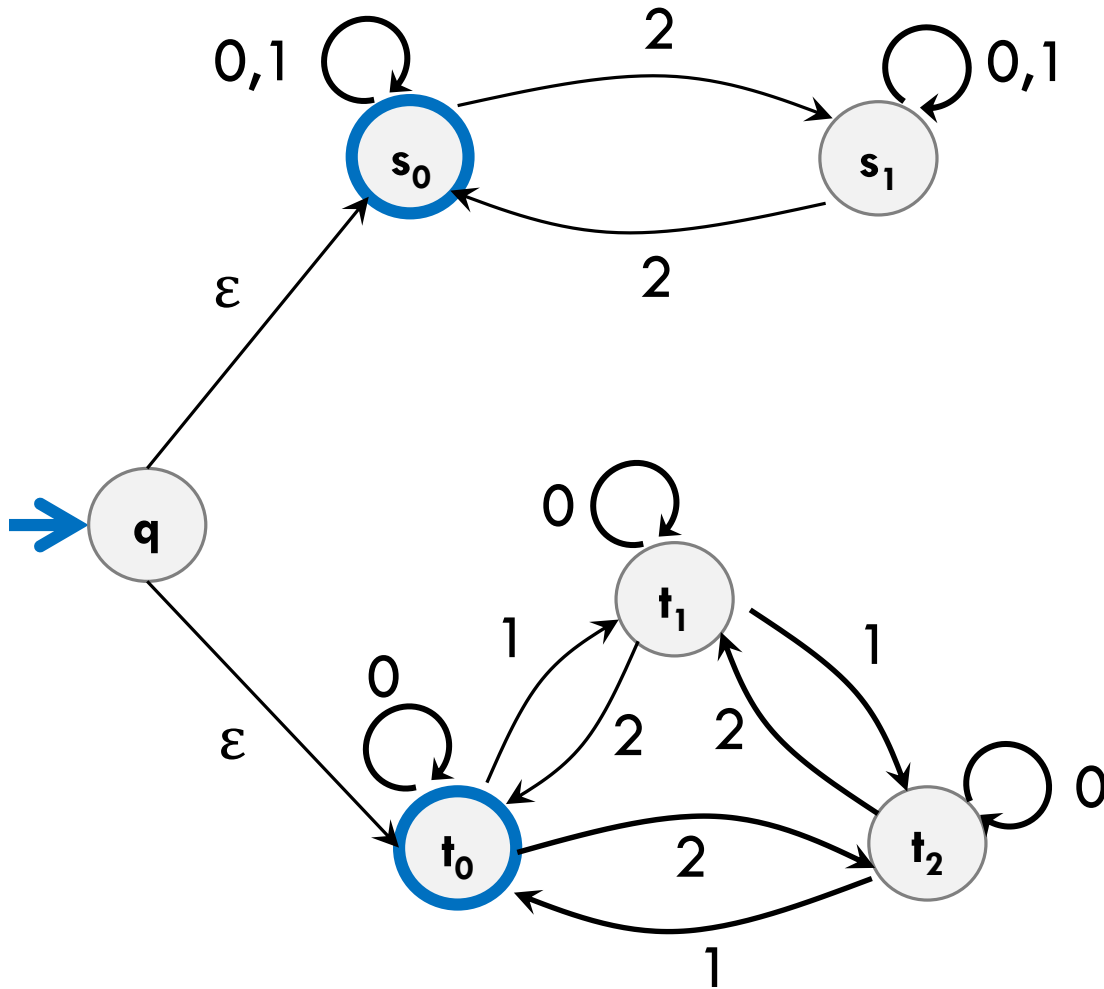

The set of strings over $\{0,1,2\}$ with an even number of 2's or the sum $\%3 = 0$.

NFA that recognizes "binary strings with a 1 in the third position from the end"

"**Perfect Guesser**": The NFA has input x , and whenever there is a choice of what to do, it **magically** guesses a transition that will eventually lead to acceptance (if one exists)

Perfect guesser view makes this easier.

Design an NFA for the language in the title.

[Pollev.com/uwcse311](https://pollev.com/uwcse311)

NFA that recognizes "binary strings with a 1 in the third position from the end"

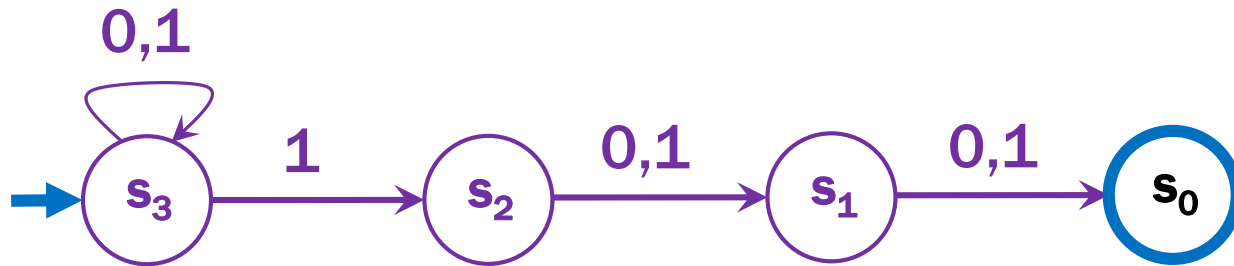

That's WAY easier than the DFA...

Parallel Exploration view of an NFA

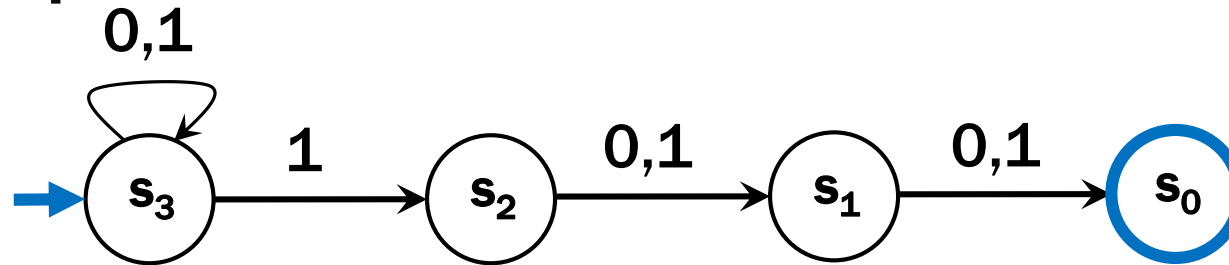

Input string 0101100

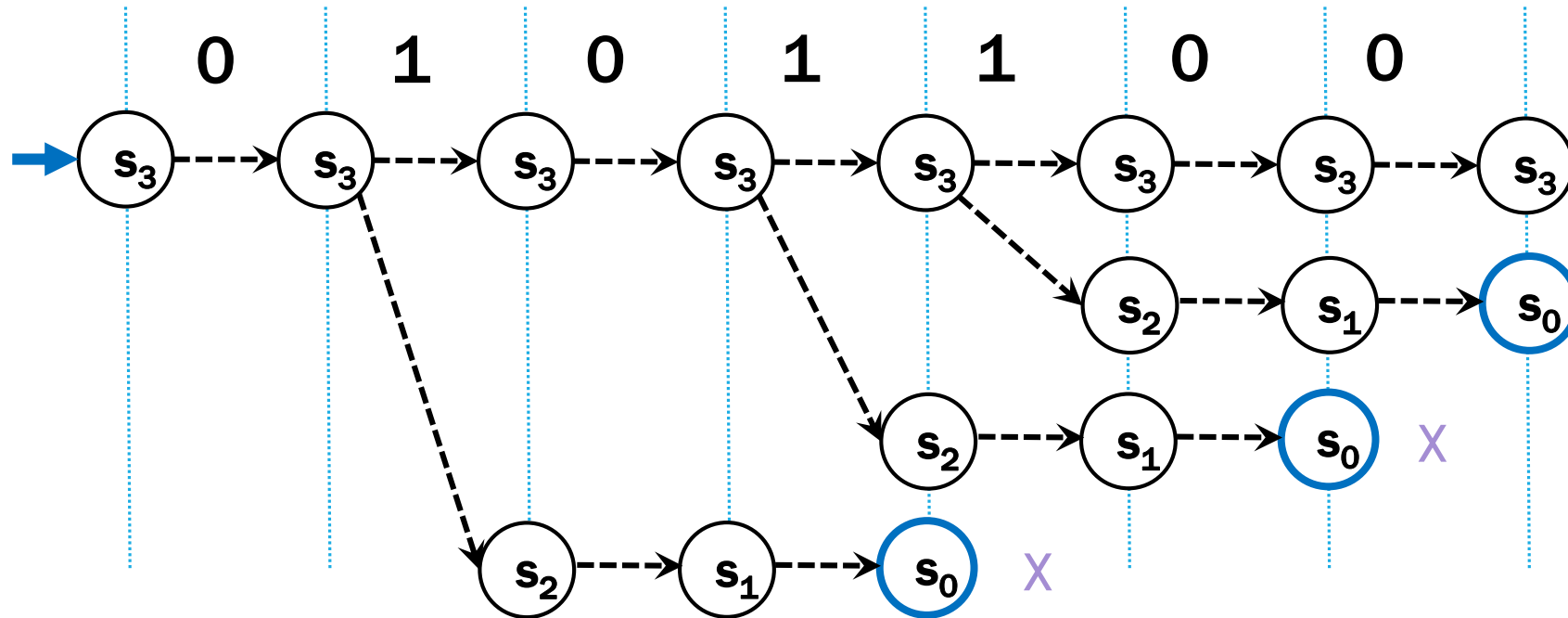

More NFA practice

Write an NFA for:

Strings over $\{0,1,2\}$ that contain at least three 0's.

Strings over $\{0,1,2\}$ where the number of 2's is even **and** the sum of the digits $\%3=0$.

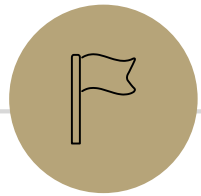

Regular Languages



Regularity

So NFAs/DFAs what can and can't they do?

Can NFAs do more than DFAs?

How do they relate to context-free-grammars? Regular expressions?

i.e. is there a language L such that L is the language of an NFA but not a DFA? Or vice versa?

What about CFGs/regexes?

[Pollev.com/uwcse311](https://pollev.com/uwcse311)

Regularity

So NFAs/DFAs what can and can't they do?

Can NFAs do more than DFAs?

How do they relate to context-free-grammars? Regular expressions?

Kleene's Theorem

For every language L :

L is the language of a regular expression if and only if

L is the language of a DFA if and only if

L is the language of an NFA

Regularity

So NFAs, DFAs, and regular expressions are all “equally powerful”

Every language either can be expressed with any of them or none of them.

A set of strings that is recognized by a DFA (equivalently, recognized by an NFA; equivalently, the language of a regular expression) is called a **regular language**.

So to show a language is “regular” you just need to show one of these and prove it works. There are some “irregular” languages (that don’t have a corresponding NFA/DFA/regex)

Proof [sketch]

L is the language
of an NFA.

L is the language
of a regular
expression.

This is just a "sketch" of the proof. We want you to get the intuition for why this is true, we'll go very quickly for some cases.

L is the language
of a DFA.

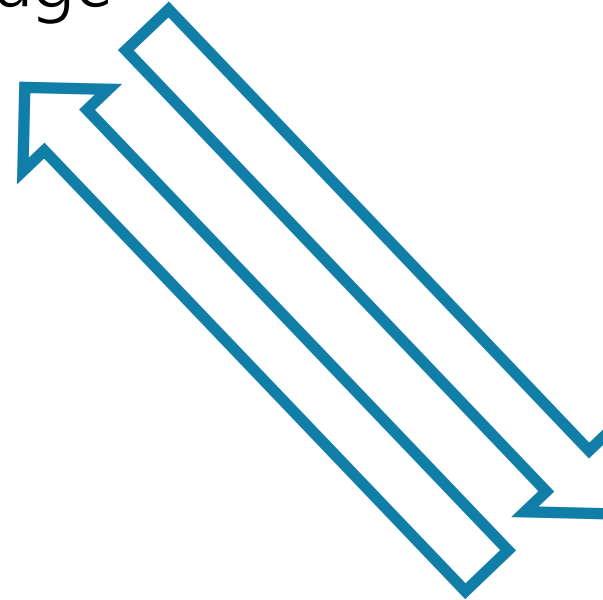
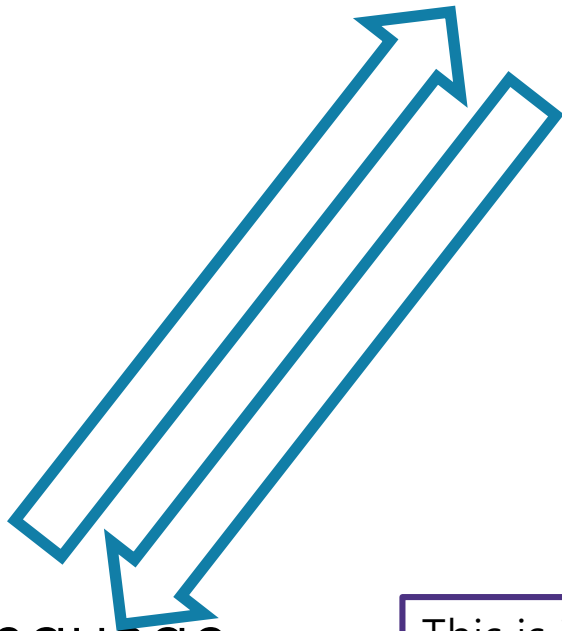

Proof [sketch]

L is the language of an NFA.

L is the language of a regular expression.

Suppose L is the language of some DFA M . M also satisfies the requirements for an NFA, so L is also the language of an NFA.

L is the language of a DFA.

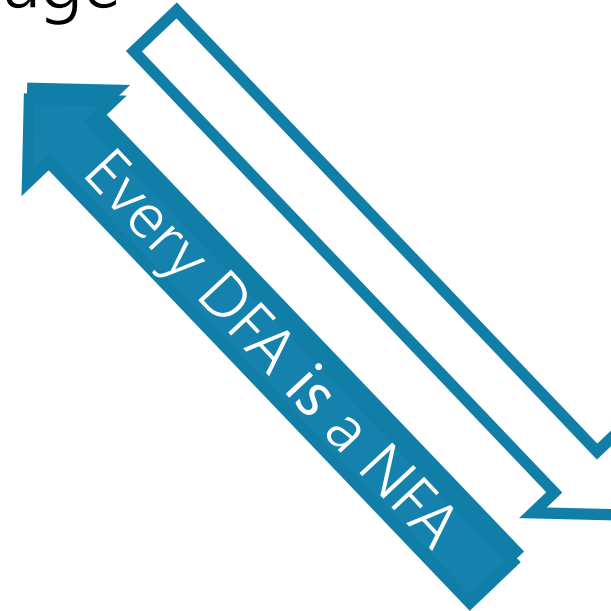

Proof [sketch]

L is the language of a regular expression.

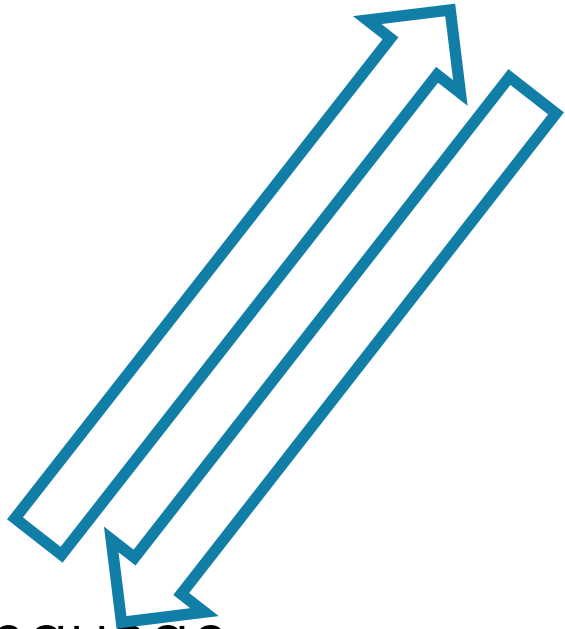

L is the language of an NFA.

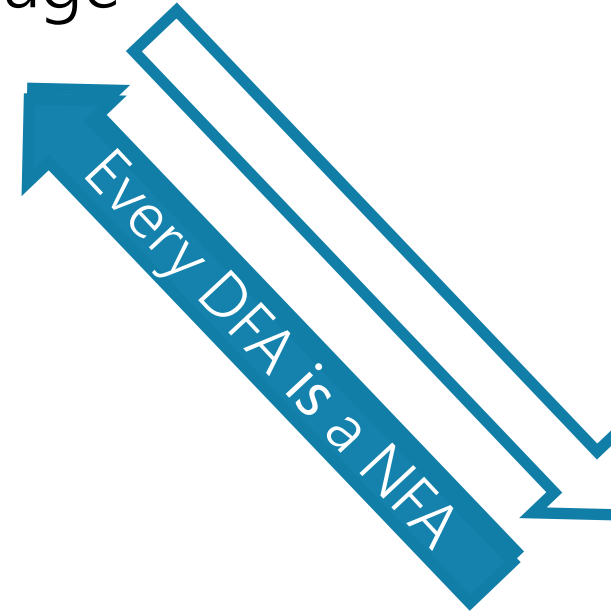

L is the language of a DFA.

Every regular expression has a corresponding NFA.

Proof by...

Structural induction!

Regular expressions are recursively defined, so we can prove something about every regular expression via induction.

What was that definition again...

Regular Expressions

Basis:

ε is a regular expression. The empty string itself matches the pattern (and nothing else does).

\emptyset is a regular expression. No strings match this pattern.

a is a regular expression, for any $a \in \Sigma$ (i.e. any character). The character itself matching this pattern.

Recursive

If A, B are regular expressions then $(A \cup B)$ is a regular expression
matched by any string that matches A or that matches B [or both]).

If A, B are regular expressions then AB is a regular expression.
matched by any string x such that $x = yz$, y matches A and z matches B .

If A is a regular expression, then A^* is a regular expression.
matched by any string that can be divided into 0 or more strings that match A .

Let $P(A)$ be "There is an NFA whose language is the same as the language for A ."

Base Cases:

\emptyset

ε

a ($a \in \Sigma$)

Let $P(A)$ be "There is an NFA whose language is the same as the language for A ."

Base Cases:



Let $P(A)$ be "There is an NFA whose language is the same as the language for A ."

Inductive Hypothesis: Let A, B be arbitrary regular expressions. Suppose $P(A)$ and $P(B)$.

Inductive Step: **Case $A \cup B$**

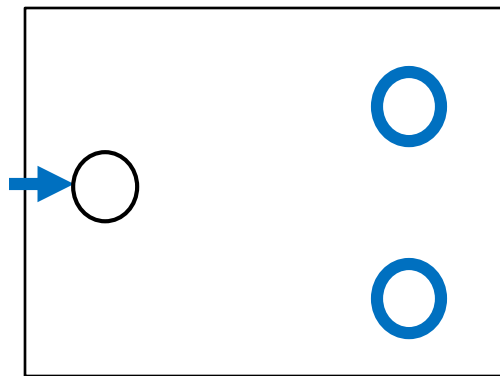

N_A

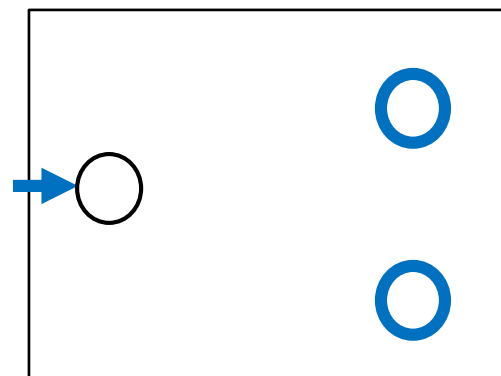

N_B

Only a sketch for this proof – so we'll just doodle stuff. Let N_A recognize A 's language, and N_B recognize B 's language.

Let $P(A)$ be "There is an NFA whose language is the same as the language for A ."

Inductive Hypothesis: Let A, B be arbitrary regular expressions. Suppose $P(A)$ and $P(B)$.

Inductive Step: **Case $A \cup B$**

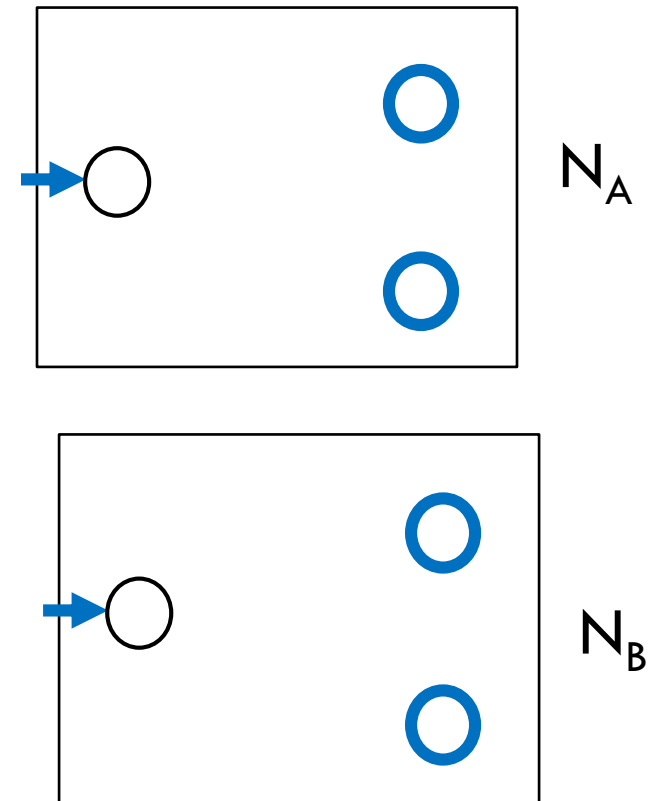

Want a machine that accepts exactly strings matched by A or B .

Let $P(A)$ be "There is an NFA whose language is the same as the language for A ."

Inductive Hypothesis: Let A, B be arbitrary regular expressions. Suppose $P(A)$ and $P(B)$.

Inductive Step: **Case $A \cup B$**

Match $A \cup B$? Then you match one of the two regexes. New machine transitions into start state of appropriate old machine. Will be accepted.
Accepted by the machine? First step **has** to be an ϵ -transition into one of the machines, so would have been accepted by the smaller machine, so must have matched A or B .

Want a machine that accepts exactly strings matched by A or B .

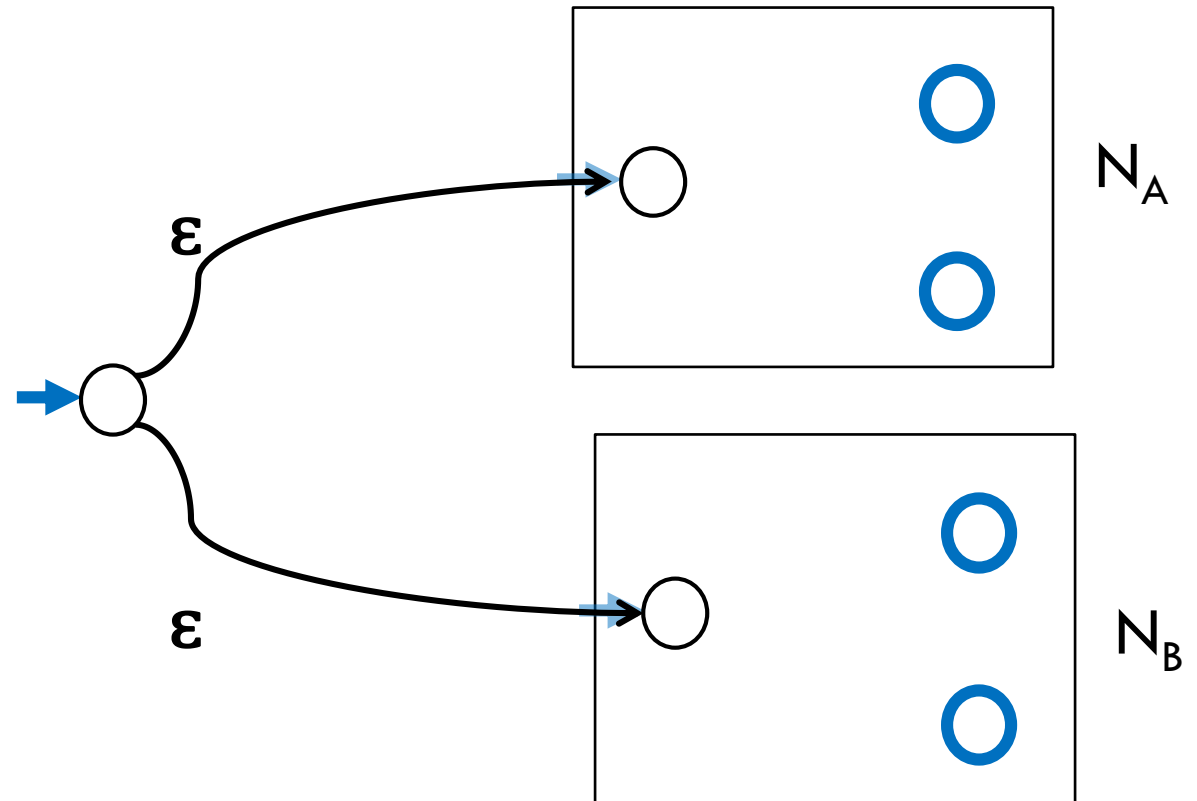

Let $P(A)$ be "There is an NFA whose language is the same as the language for A ."

Inductive Hypothesis: Let A, B be arbitrary regular expressions. Suppose $P(A)$ and $P(B)$.

Inductive Step: **Case AB**

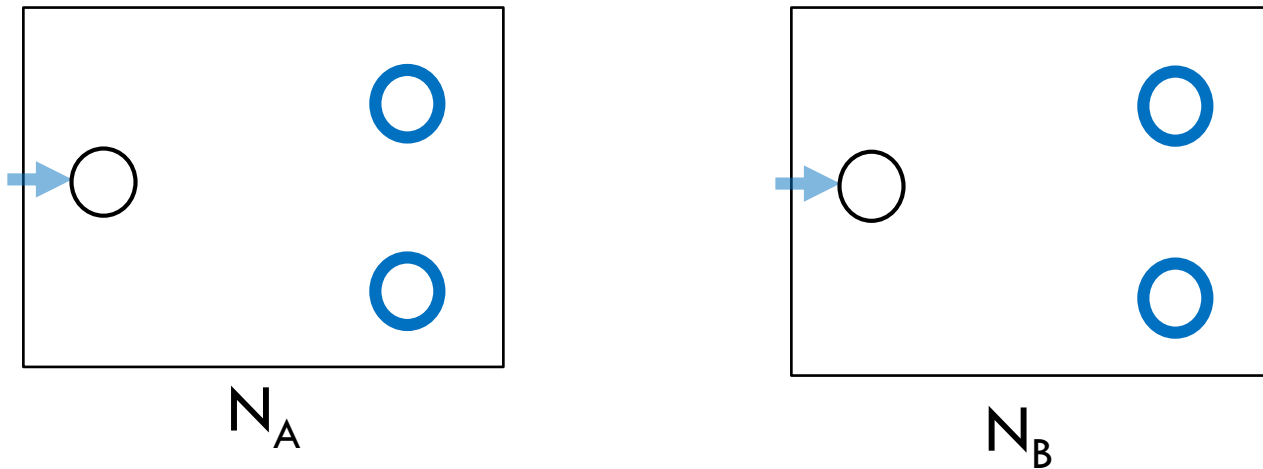

Want a machine that accepts exactly strings matched by AB .

Let $P(A)$ be "There is an NFA whose language is the same as the language for A ."

Inductive Hypothesis: Let A, B be arbitrary regular expressions. Suppose $P(A)$ and $P(B)$.

Inductive Step: **Case AB**

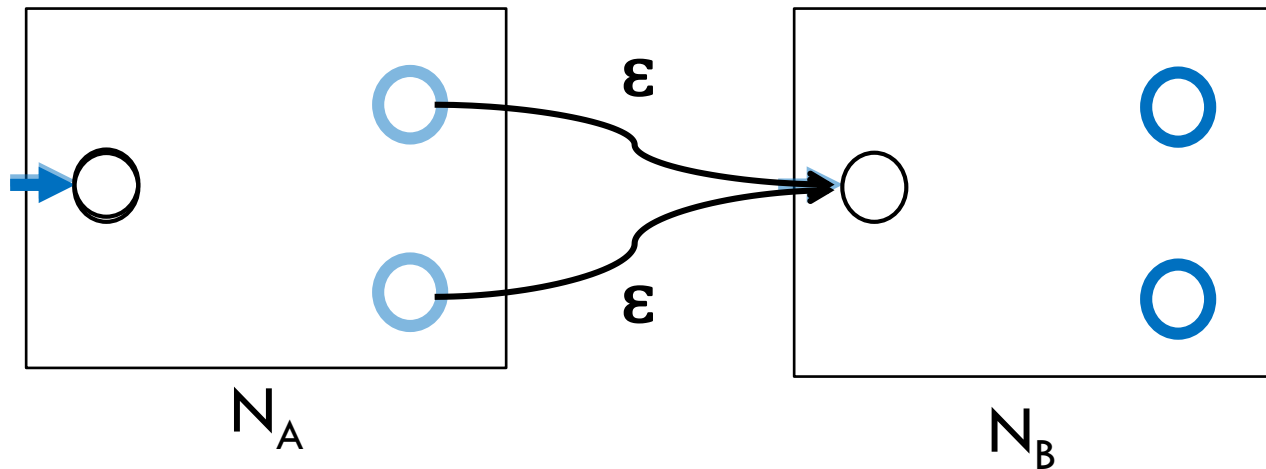

String x that matches AB can divide into yz where y matches A , z matches B .

NFA can run as N_A would on y take ϵ -transition, then run as N_B would on z so accepted by N
String x that is accepted?

N must run in N_A take ϵ -transition, then run in N_B until acceptance. Substring read in N_A must match A . Substring read in N_B must match B (by IH) so string matches AB .

Want a machine that accepts exactly strings matched by AB .

Let $P(A)$ be "There is an NFA whose language is the same as the language for A ."

Inductive Hypothesis: Let A, B be arbitrary regular expressions. Suppose $P(A)$ and $P(B)$.

Inductive Step: **Case A^***

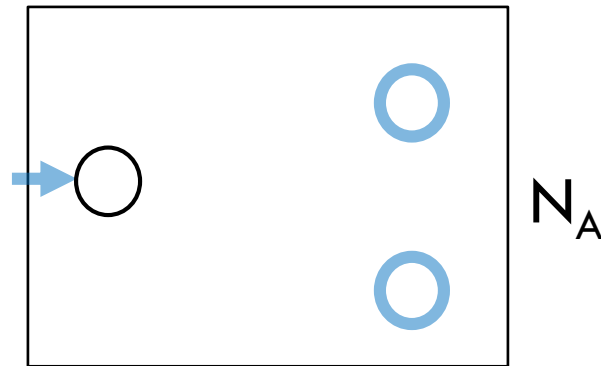

Want a machine that accepts exactly strings matched by A^* .

Let $P(A)$ be "There is an NFA whose language is the same as the language for A ."

Inductive Hypothesis: Let A, B be arbitrary regular expressions. Suppose $P(A)$ and $P(B)$.

Inductive Step: **Case A^***

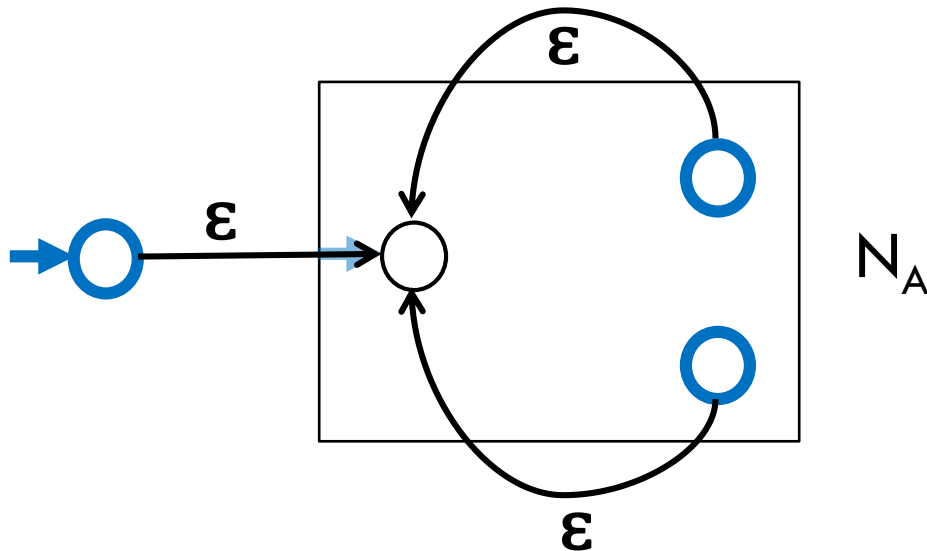

If x matches A^* , then by def of $*$ $x = \epsilon$ or $x = x_1 \dots x_k$ with each x_i matching A . If $x = \epsilon$, machine accepts by not transitioning. Otherwise run accepting computation in N_A for each x_i return to start until x_k then end in accept state (all possible by IH)

If accepted by N ,

Either ϵ or go from start state of N_A to final state and ϵ -transition back to start some number of times. So we can break string into parts accepted by N_A by IH we can break string into substrings all matched by A , i.e. we match A^* .

Want a machine that accepts exactly strings matched by A^* .

Let $P(A)$ be "There is an NFA whose language is the same as the language for A ."

By principle of structural induction, $P(A)$ holds for all regular expressions A .

Thus every regular expression has an equivalent NFA.



Every regex has an equivalent NFA

An example

$(01 \cup 1)^*0$

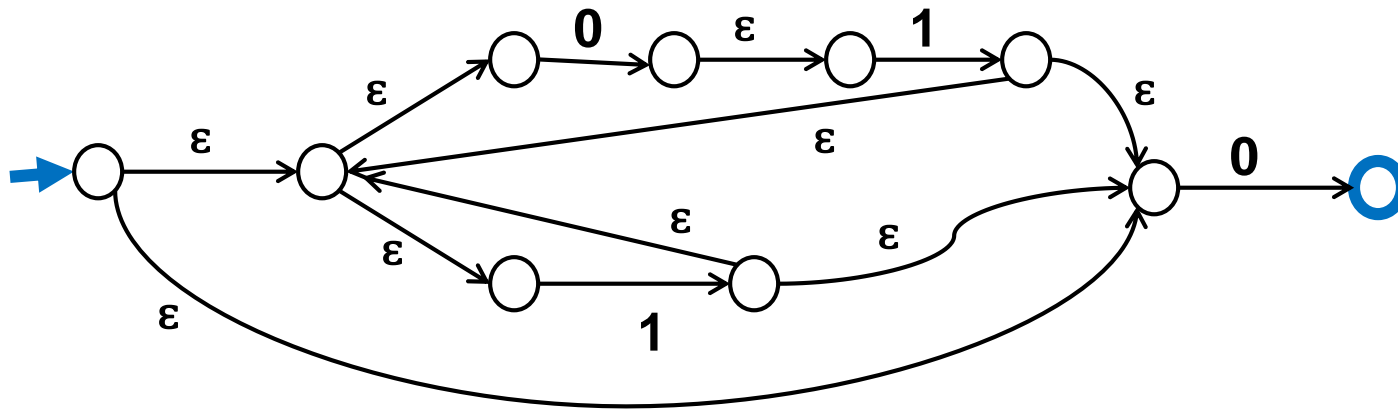

Proof [sketch]

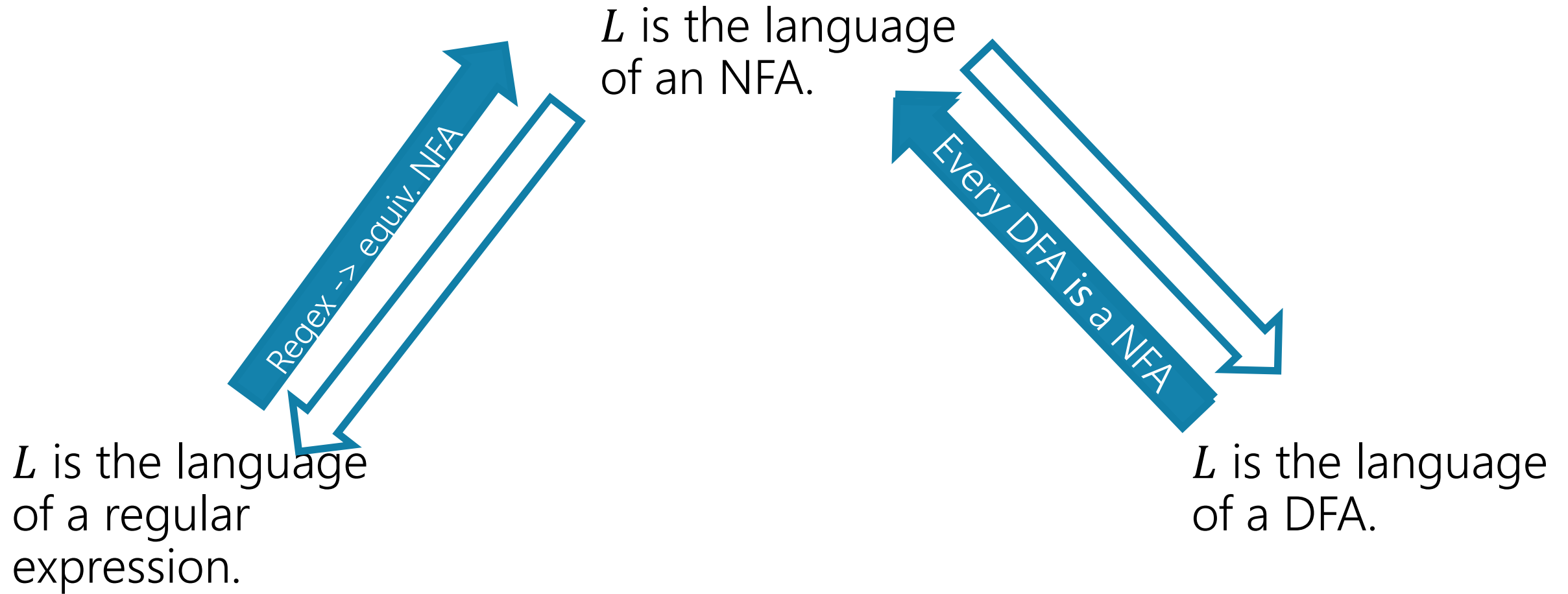

Can we convert an NFA to a DFA?

NFAs are magic though! DFAs can't guess...

Parallel exploration: The NFA computation runs all possible computations on x step-by-step at the same time in parallel

At any step, the set of all possible states we could be in is fixed!

And the update steps are deterministic if we just check all possibilities!

Parallel Exploration view of an NFA

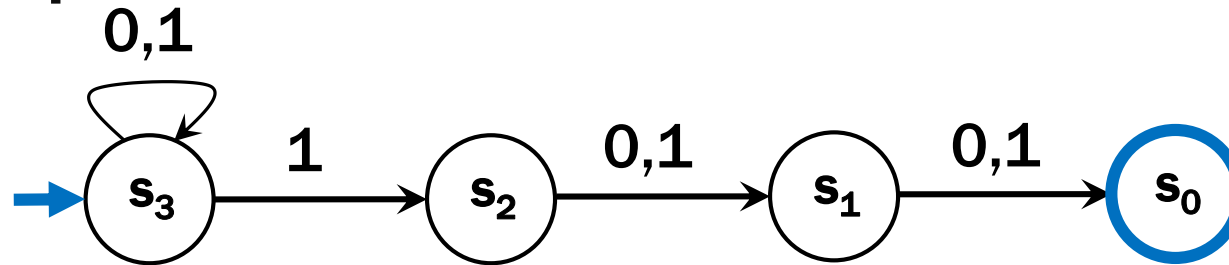

Input string 0101100

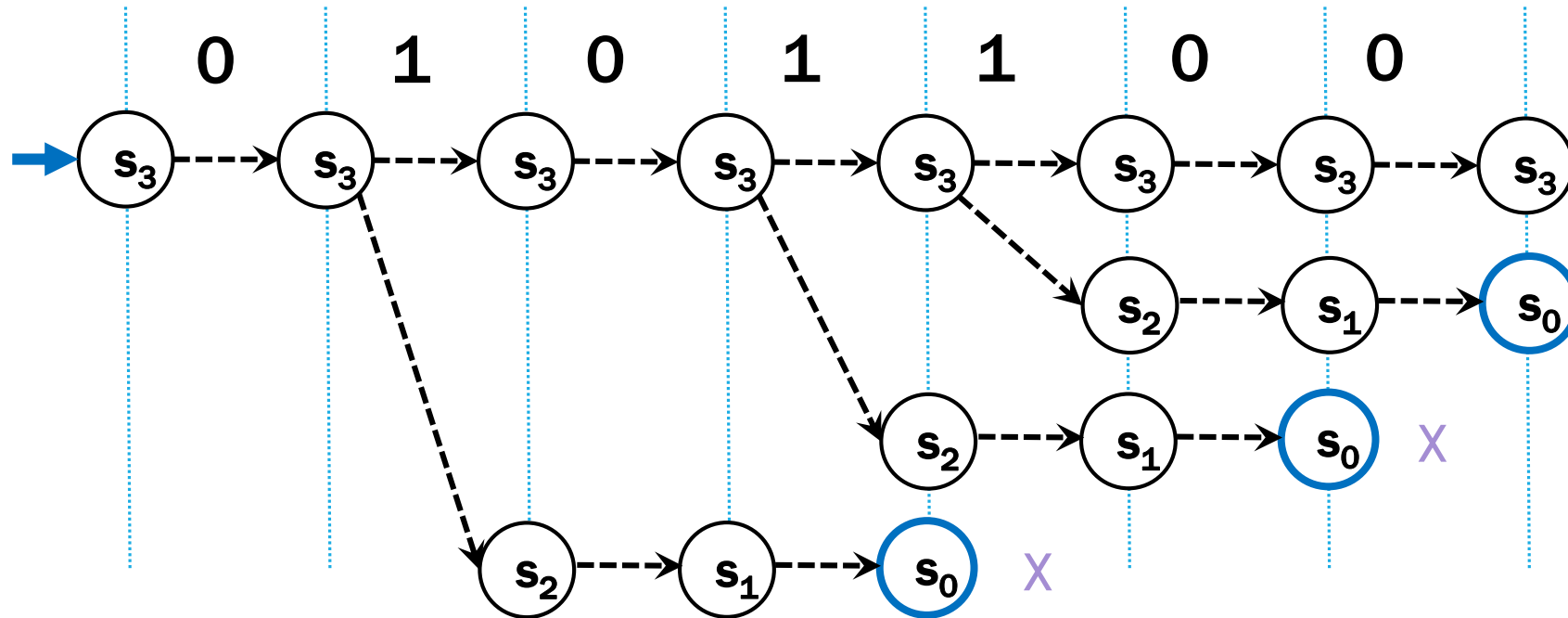

Can we convert an NFA to a DFA?

NFAs are magic though! DFAs can't guess...

Parallel exploration: The NFA computation runs all possible computations on x step-by-step at the same time in parallel

At any step, the set of all possible states we could be in is fixed!

And the update steps are deterministic if we just check all possibilities!

Converting from an NFA to a DFA

Let N be an NFA with a set of states S .

Need to define a DFA D that recognizes the same language.

Let D be a DFA with set of states $\mathcal{P}(S)$.

How do we update?

If I'm in a set of states X , if the next character to be read is a

Transition to $\{y: \exists x \in X \text{ such that } y \text{ is reachable from } x \text{ in } N \text{ using exactly one } a \text{ transition and any number of } \varepsilon\text{-transitions}\}$.

An example (starting point)

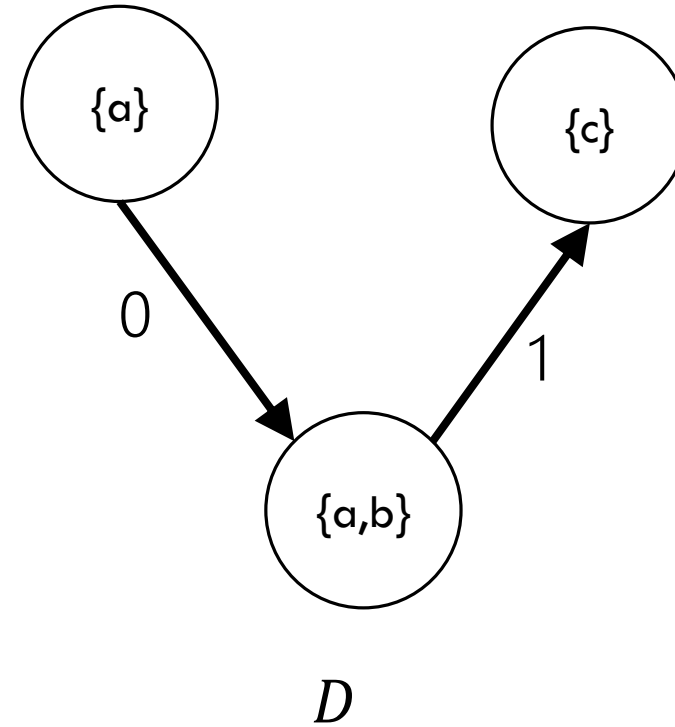
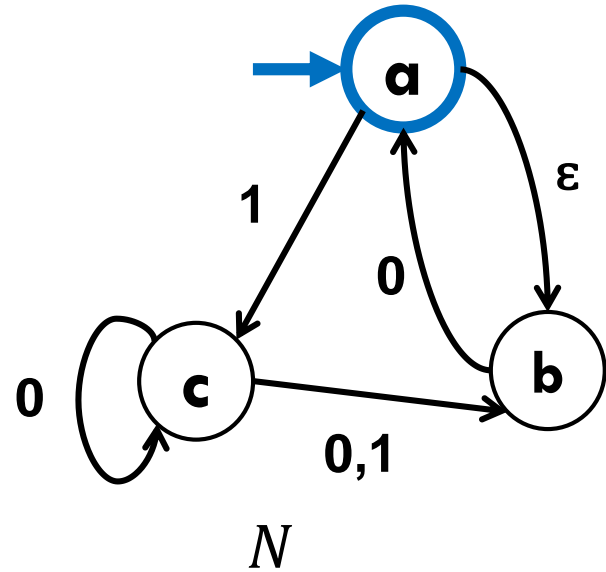

Finishing the DFA

What about start and accept states?

The start state of D is $\{x: x \text{ is the start state of } N \text{ or } x \text{ is reachable from the start state of } N \text{ with only } \varepsilon\text{-transitions}\}$

i.e. the states the NFA could be in before reading a character of the input.

Final states? X is a final state if there is an $x \in X$ such that x is a final state of N . (If at least one version of the computation is in a final state, then the NFA will accept)

An example

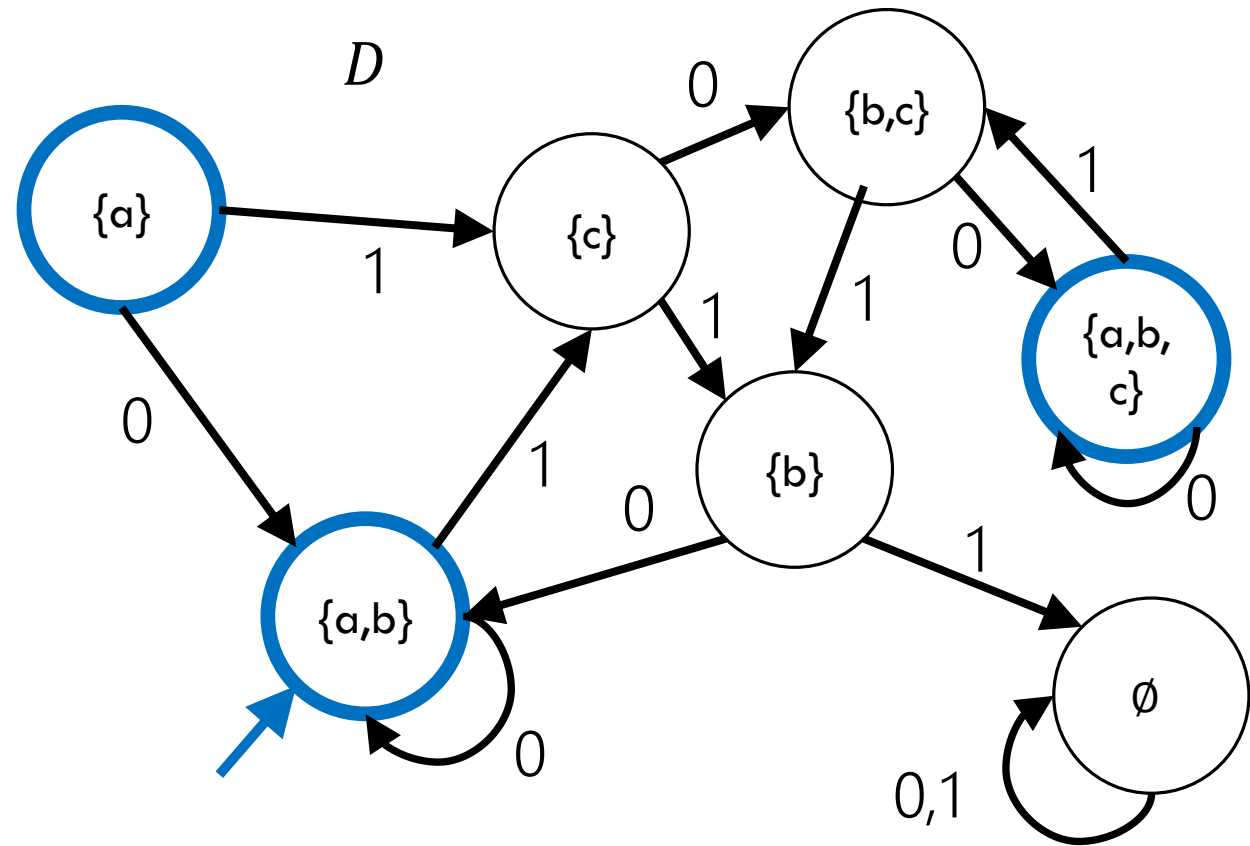
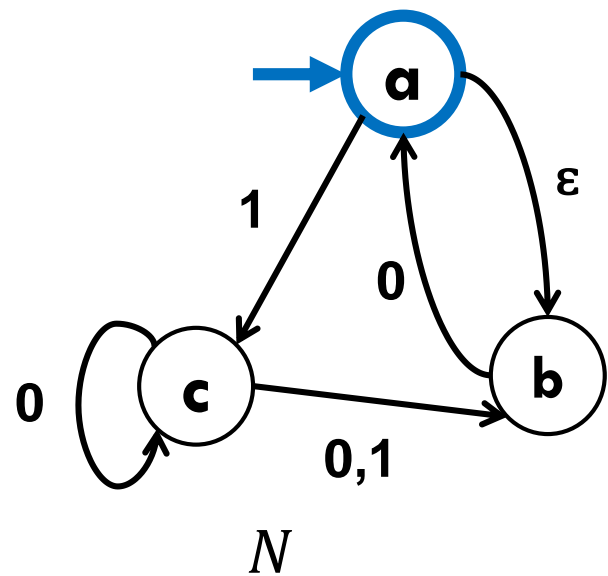

More formally (the “powerset construction”)

The original NFA

States: Q

Start state: q_0

Transition function: $\delta(q, a)$

Outputs set of all states reachable from q using one a transition (and any number of ε -transitions)

Final States: F

The constructed DFA

States: $\mathcal{P}(Q)$

Start state: $\{q' : q' \text{ reachable from } q_0 \text{ with only } \varepsilon\text{-transitions}\}$

Transition function: $\delta_D(S, a) = \bigcup_{q \in S} \delta(q, a)$.

Final States: $\{S : S \cap F \neq \emptyset\}$

Proof Sketch

Define $P(n)$: "on all strings of length n , the set of states the NFA could be in processing n corresponds to the state the DFA is in"

Show $P(n)$ for all n by induction.

The choices of start and final states ensure x is accepted by the NFA if and only if it is accepted by the DFA.

Proof [sketch]

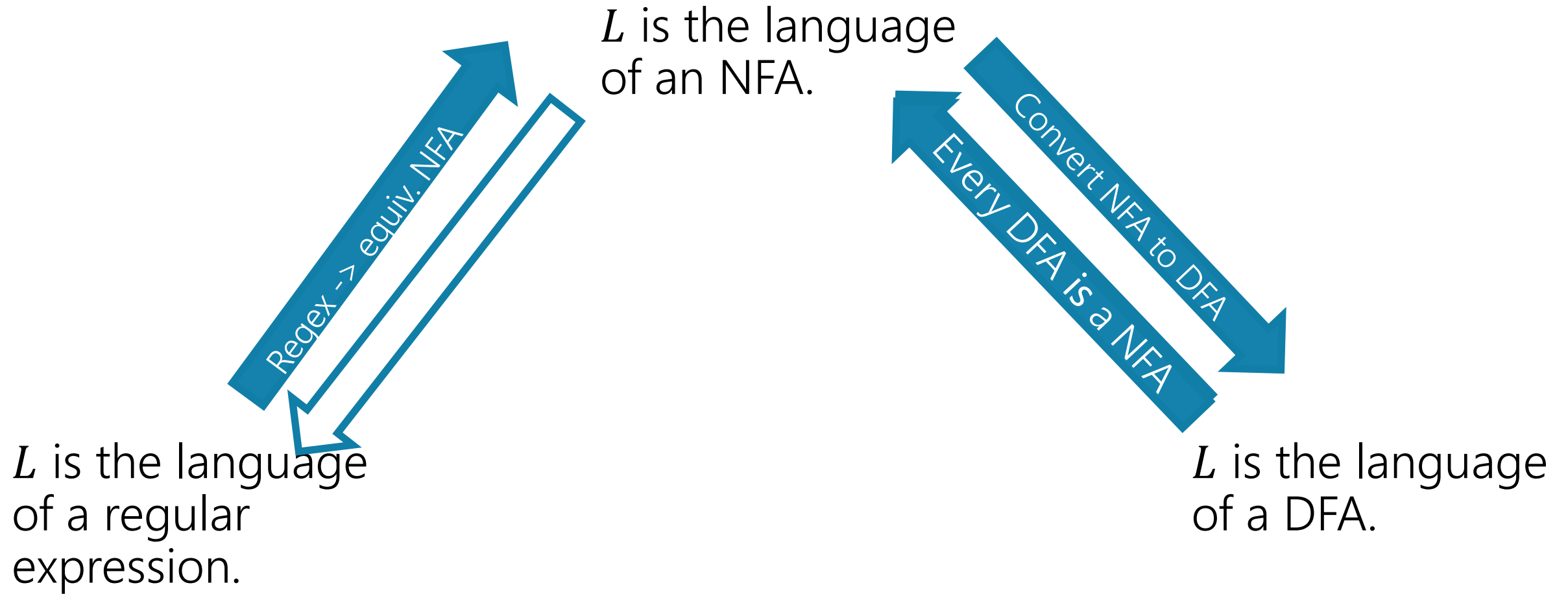

Takeaways

Nondeterminism wasn't magic. It was just efficiency.

The construction we had would turn a k state NFA into a 2^k state DFA.

For some languages there might be a smaller DFA. But for some it really is (essentially) that big.

“string has a 1 in the k^{th} character from the end” is an example.

The P vs. NP question asks whether nondeterminism is similar for running time on our computers (it doesn't let you do anything new, but it lets you do it MUCH more efficiently).

Next time: Showing a language is not regular!

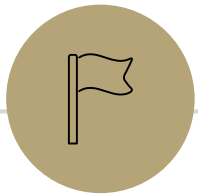

Enrichment Content

(optional) sketch that for every NFA there is an equivalent regular expression.

Every NFA has an equivalent regular expression

Not responsible for this, but if you're curious:

Generalized NFAs

Like NFAs but allow

Parallel edges

Regular Expressions as edge labels

-NFAs already have edges labeled ϵ or a

An edge labeled by A can be followed by reading a string of input chars that is in the language represented by A

Defn: A string x is accepted iff there is a *path* from start to final state *labeled by a regular expression* whose language contains x

Starting from an NFA

- Add new start state and final state

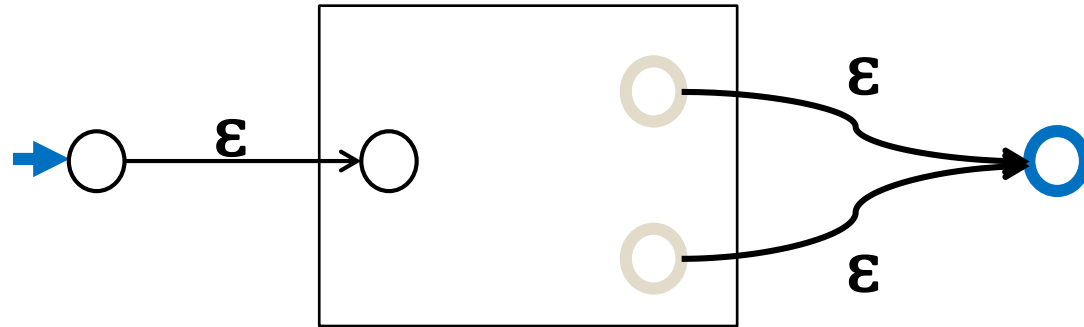

Then eliminate original states one by one, keeping the same language, until it looks like:

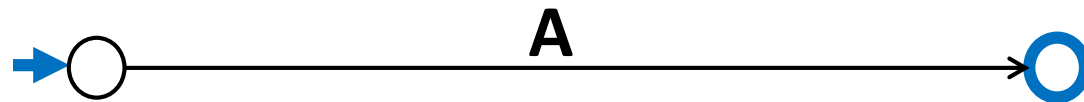

Final regular expression will be **A**

Only two simplification rules

Rule 1: For any two states q_1 and q_2 with parallel edges (possibly $q_1=q_2$), replace

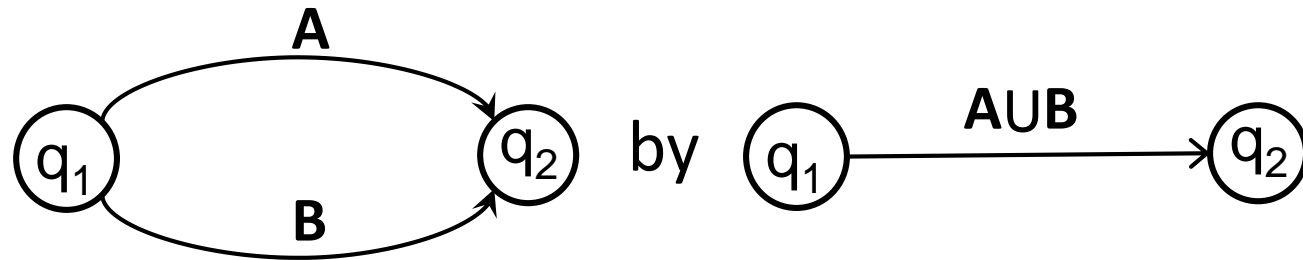

Rule 2: Eliminate non-start/final state q_3 by replacing all

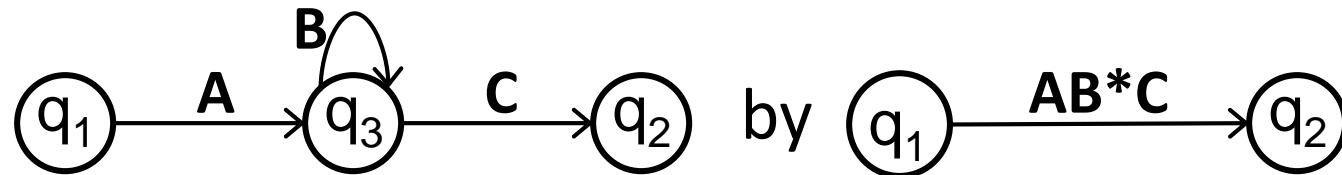

for *every* pair of states q_1 , q_2 (even if $q_1=q_2$)

Converting an NFA to a regular expression

Consider the DFA for the mod 3 sum

Accept strings from $\{0,1,2\}^*$ where the digits mod 3 sum of the digits is 0

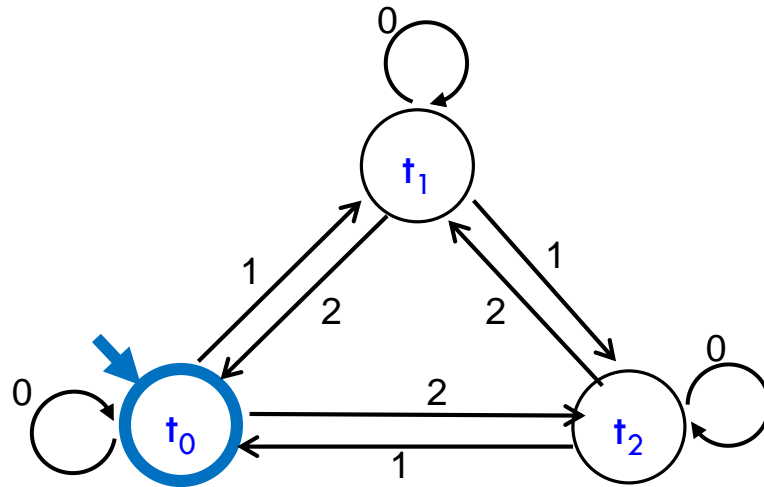

Splicing out a state t_1

Regular expressions to add to edges

$t_0 \rightarrow t_1 \rightarrow t_0$: 10^*2

$t_0 \rightarrow t_1 \rightarrow t_2$: 10^*1

$t_2 \rightarrow t_1 \rightarrow t_0$: 20^*2

$t_2 \rightarrow t_1 \rightarrow t_2$: 20^*1

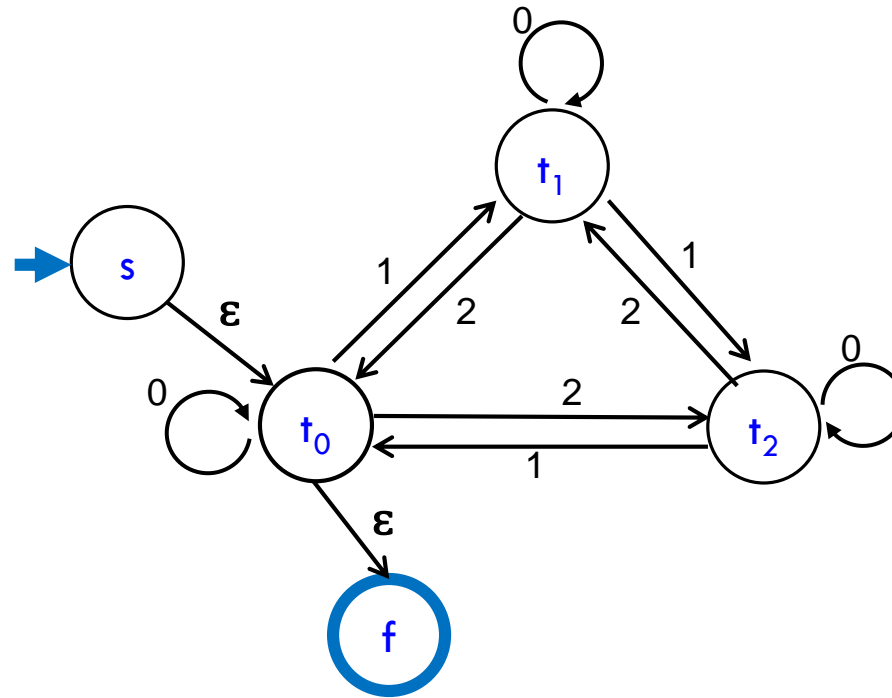

Splicing out a state t_1

Regular expressions to add to edges

$t_0 \rightarrow t_1 \rightarrow t_0$: 10^*2

$t_0 \rightarrow t_1 \rightarrow t_2$: 10^*1

$t_2 \rightarrow t_1 \rightarrow t_0$: 20^*2

$t_2 \rightarrow t_1 \rightarrow t_2$: 20^*1

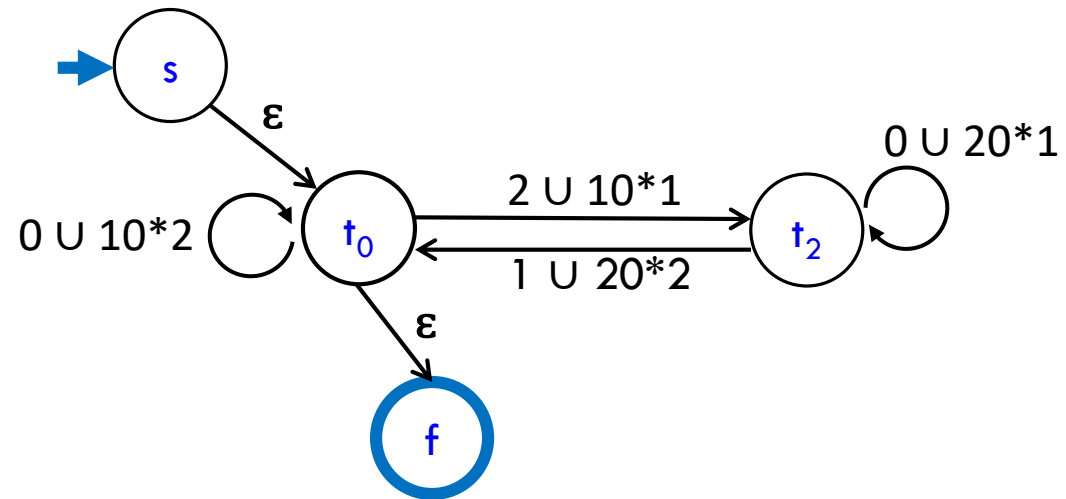

Splicing out state t_2 (and then t_0)

$R_1: 0 \cup 10^*2$
 $R_2: 2 \cup 10^*1$
 $R_3: 1 \cup 20^*2$
 $R_4: 0 \cup 20^*1$

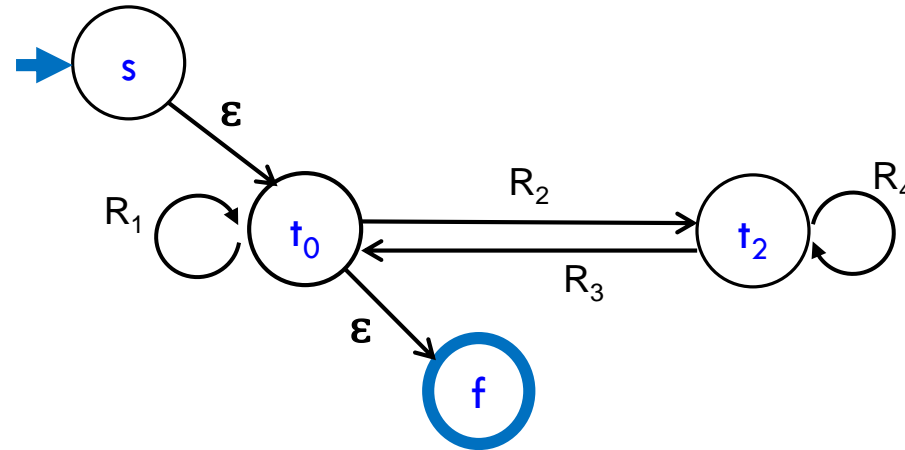

$R_5: R_1 \cup R_2R_4^*R_3$

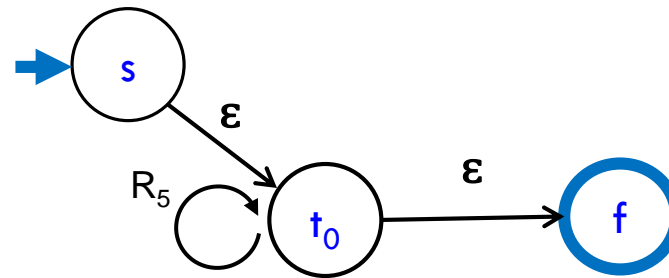

Final regular expression: $R_5^* =$

$(0 \cup 10^*2 \cup (2 \cup 10^*1)(0 \cup 20^*1)^*(1 \cup 20^*2))^*$

Proof [sketch]

