

CSE 311: Foundations of Computing

Lecture 5: DNF, CNF and Predicate Logic

Apologies about
Discussion Board.

CSE Support is
working to correct
problems. Keep

sending us
e-mail if you

- can't read
- can't post.

(It is something to do
with synchronizing with
NW enrollment info)

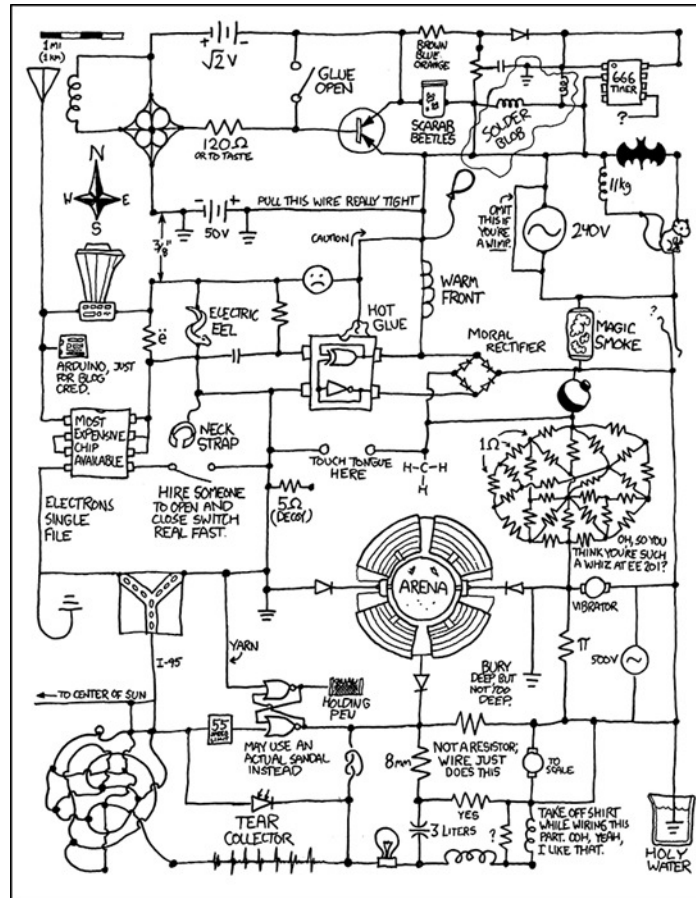

1-bit Binary Adder

A	$0 + 0 = 0$ (with $C_{OUT} = 0$)
<u>+ B</u>	$0 + 1 = 1$ (with $C_{OUT} = 0$)
S	$1 + 0 = 1$ (with $C_{OUT} = 0$)
(C_{OUT})	$1 + 1 = 0$ (with $C_{OUT} = 1$)

Idea: These are chained together, with a carry-in

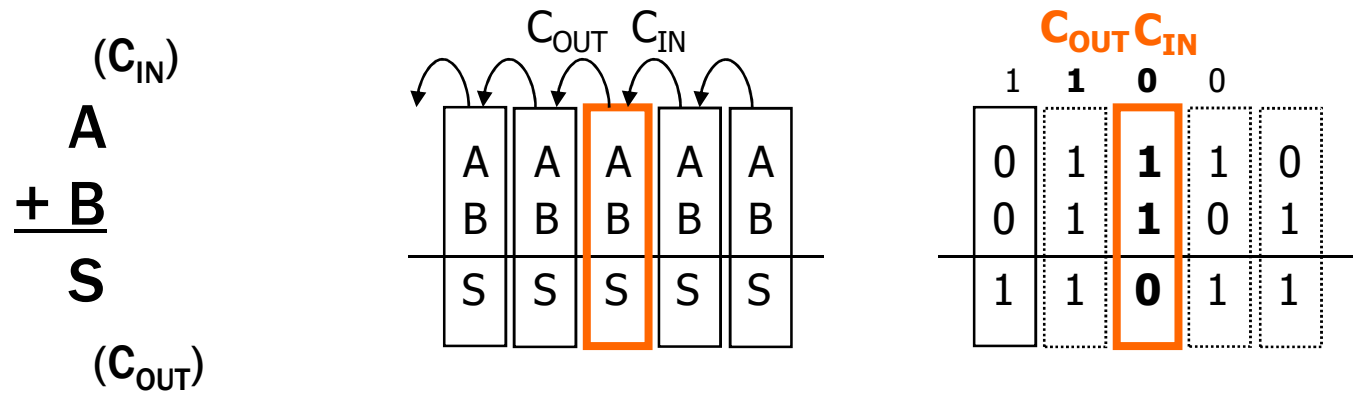

1-bit Binary Adder

- **Inputs:** A, B, Carry-in
- **Outputs:** Sum, Carry-out

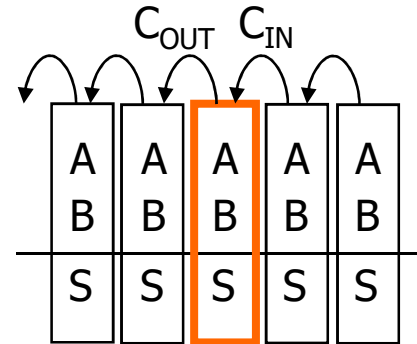

A	B	C _{IN}	C _{OUT}	S
0	0	0	0	0
0	0	1	0	1
0	1	0	0	1
0	1	1	1	0
1	0	0	0	1
1	0	1	1	0
1	1	0	1	0
1	1	1	1	1



1-bit Binary Adder

- **Inputs:** A, B, Carry-in
- **Outputs:** Sum, Carry-out

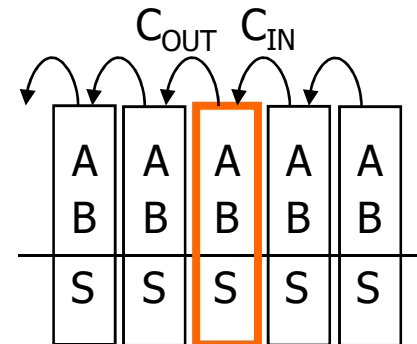

A	B	C_{IN}	C_{OUT}	S
0	0	0	0	0
0	0	1	0	1
0	1	0	0	1
0	1	1	1	0
1	0	0	0	1
1	0	1	1	0
1	1	0	1	0
1	1	1	1	1

Derive an expression for S

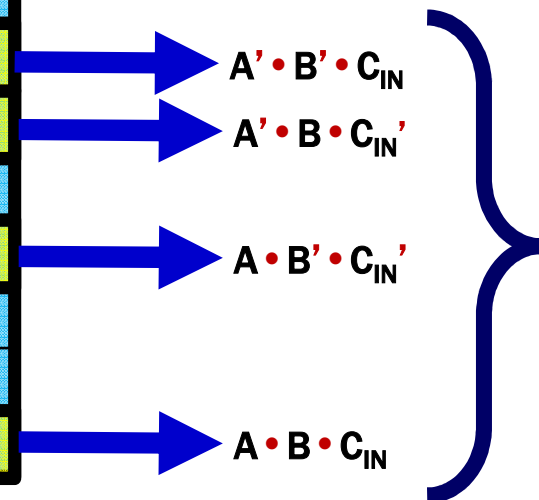

$$S = A' \cdot B' \cdot C_{IN} + A' \cdot B \cdot C_{IN}' + A \cdot B' \cdot C_{IN}' + A \cdot B \cdot C_{IN}$$

1-bit Binary Adder

- **Inputs:** A, B, Carry-in
- **Outputs:** Sum, Carry-out

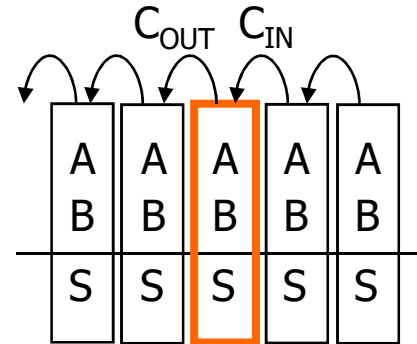

A	B	C_{IN}	C_{OUT}	S
0	0	0	0	0
0	0	1	0	1
0	1	0	0	1
0	1	1	1	0
1	0	0	0	1
1	0	1	1	0
1	1	0	1	0
1	1	1	1	1

Derive an expression for C_{OUT}

$$A' \cdot B \cdot C_{IN}$$

$$A \cdot B' \cdot C_{IN}$$

$$A \cdot B \cdot C_{IN}'$$

$$A \cdot B \cdot C_{IN}$$

$$C_{OUT} = A' \cdot B \cdot C_{IN} + A \cdot B' \cdot C_{IN} + A \cdot B \cdot C_{IN}' + A \cdot B \cdot C_{IN}$$

$$S = A' \cdot B' \cdot C_{IN} + A' \cdot B \cdot C_{IN}' + A \cdot B' \cdot C_{IN}' + A \cdot B \cdot C_{IN}$$

1-bit Binary Adder

- **Inputs:** A, B, Carry-in
- **Outputs:** Sum, Carry-out

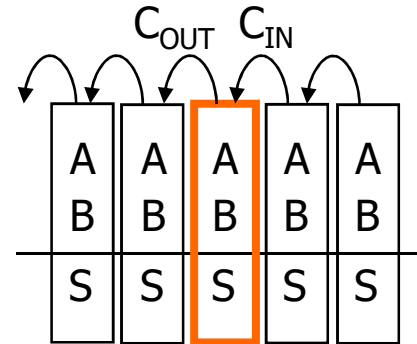

A	B	C_{IN}	C_{OUT}	S
0	0	0	0	0
0	0	1	0	1
0	1	0	0	1
0	1	1	1	0
1	0	0	0	1
1	0	1	1	0
1	1	0	1	0
1	1	1	1	1

$$S = A' \cdot B' \cdot C_{IN} + A' \cdot B \cdot C_{IN}' + A \cdot B' \cdot C_{IN}' + A \cdot B \cdot C_{IN}$$

$$C_{OUT} = A' \cdot B \cdot C_{IN} + A \cdot B' \cdot C_{IN} + A \cdot B \cdot C_{IN}' + A \cdot B \cdot C_{IN}$$

Apply Theorems to Simplify Expressions

The theorems of Boolean algebra can simplify expressions

– e.g., full adder's carry-out function

$$\begin{aligned} \text{Cout} &= A' B C_{in} + A B' C_{in} + A B C_{in}' + A B C_{in} \\ &= A' B C_{in} + A B' C_{in} + A B C_{in}' + A B C_{in} + A B C_{in} \\ &= A' B C_{in} + A B C_{in} + A B' C_{in} + A B C_{in}' + A B C_{in} \\ &= (A' + A) B C_{in} + A B' C_{in} + A B C_{in}' + A B C_{in} \\ &= (1) B C_{in} + A B' C_{in} + A B C_{in}' + A B C_{in} \\ &= B C_{in} + A B' C_{in} + A B C_{in}' + A B C_{in} + A B C_{in} \\ &= B C_{in} + A B' C_{in} + A B C_{in}' + A B C_{in} \\ &= B C_{in} + A (B' + B) C_{in} + A B C_{in}' + A B C_{in} \\ &= B C_{in} + A (1) C_{in} + A B C_{in}' + A B C_{in} \\ &= B C_{in} + A C_{in} + A B (C_{in}' + C_{in}) \\ &= B C_{in} + A C_{in} + A B (1) \\ &= B C_{in} + A C_{in} + A B \end{aligned}$$

adding extra terms
creates new factoring
opportunities

A 2-bit Ripple-Carry Adder

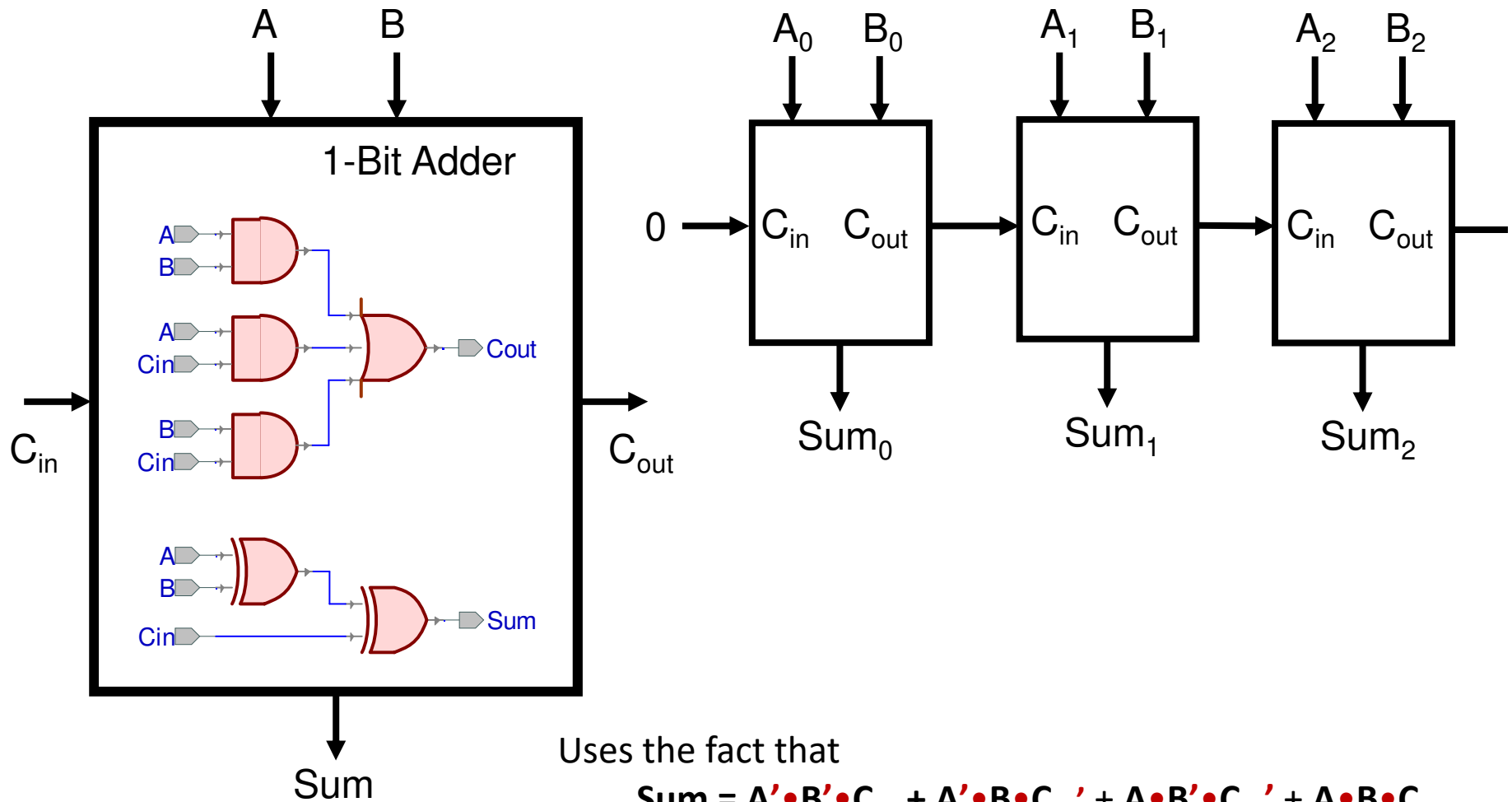

Uses the fact that

$$\text{Sum} = A' \cdot B' \cdot C_{IN} + A' \cdot B \cdot C_{IN}' + A \cdot B' \cdot C_{IN}' + A \cdot B \cdot C_{IN}$$

is equivalent to $\text{Sum} = (A \oplus B) \oplus C_{IN}$

Mapping Truth Tables to Logic Gates

Given a truth table:

1. Write the Boolean expression
2. Minimize the Boolean expression
3. Draw as gates
4. Map to available gates

A	B	C	F
0	0	0	0
0	0	1	0
0	1	0	1
0	1	1	1
1	0	0	0
1	0	1	1
1	1	0	0
1	1	1	1

②

$$\begin{aligned} F &= A'BC' + A'BC + AB'C + ABC \\ &= A'B(C' + C) + AC(B' + B) \\ &= A'B + AC \end{aligned}$$

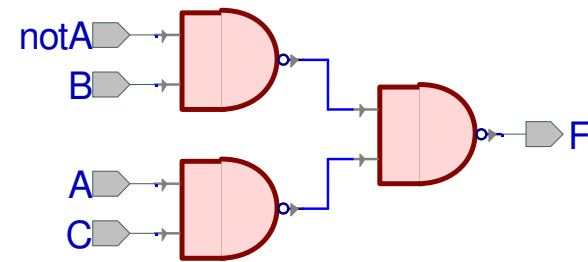
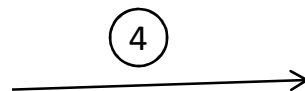
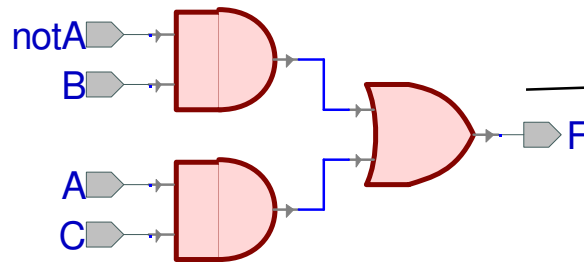
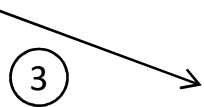

Canonical Forms

- **Truth table is the unique signature of a Boolean Function**
- **The same truth table can have many gate realizations**
 - We've seen this already
 - Depends on how good we are at Boolean simplification
- **Canonical forms**
 - Standard forms for a Boolean expression
 - We all come up with the same expression

Sum-of-Products Canonical Form

- AKA **Disjunctive Normal Form (DNF)**
- AKA **Minterm Expansion**

($\neg A \wedge \neg B \wedge C$) \vee ($\neg A \wedge B \wedge C$) \vee ($A \wedge \neg B \wedge C$) \vee ($A \wedge B \wedge \neg C$) \vee ($A \wedge B \wedge C$)

③

Add the minterms together

$$F = A'B'C + A'BC + AB'C + ABC' + ABC$$

A	B	C	F
0	0	0	0
0	0	1	1
0	1	0	0
0	1	1	1
1	0	0	0
1	0	1	1
1	1	0	1
1	1	1	1

①
Read T rows off
truth table

②
Convert to
Boolean Algebra

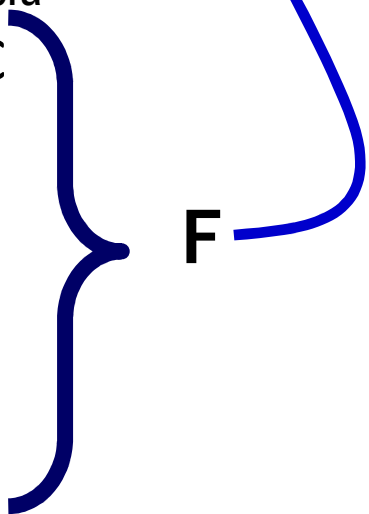
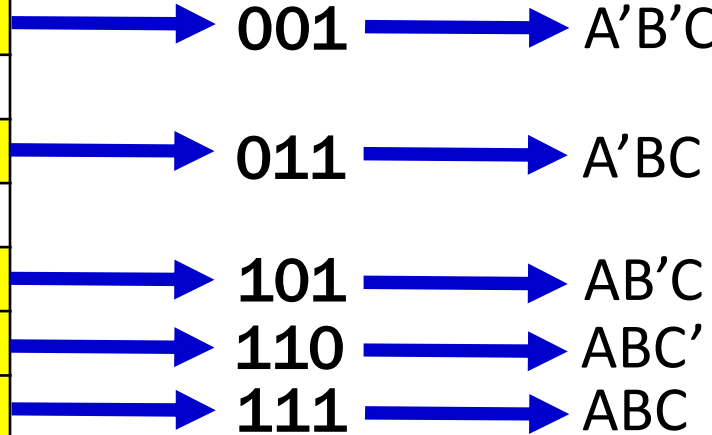

Sum-of-Products Canonical Form

Product term (or minterm)

- ANDed product of literals – input combination for which output is true
- each variable appears exactly once, true or inverted (but not both)

A	B	C	minterms
0	0	0	A'B'C'
0	0	<u>1</u>	A'B'C
0	1	0	A'BC'
0	1	<u>1</u>	A'BC
1	0	0	AB'C'
1	0	<u>1</u>	AB'C
1	1	0	ABC'
1	1	<u>1</u>	ABC

F in canonical form:

$$F(A, B, C) = \text{minterm } A'B'C + A'BC + AB'C + ABC' + ABC$$

canonical form \neq minimal form

$$\begin{aligned} F(A, B, C) &= A'B'C + A'BC + AB'C + ABC + ABC' \\ &= (A'B' + A'B + AB' + AB)C + ABC' \\ &= ((A' + A)(B' + B))C + ABC' \\ &= C + ABC' \\ &= ABC' + C \\ &= AB + C \end{aligned}$$

Product-of-Sums Canonical Form

- AKA Conjunctive Normal Form (CNF) ✖
- AKA **Maxterm Expansion**

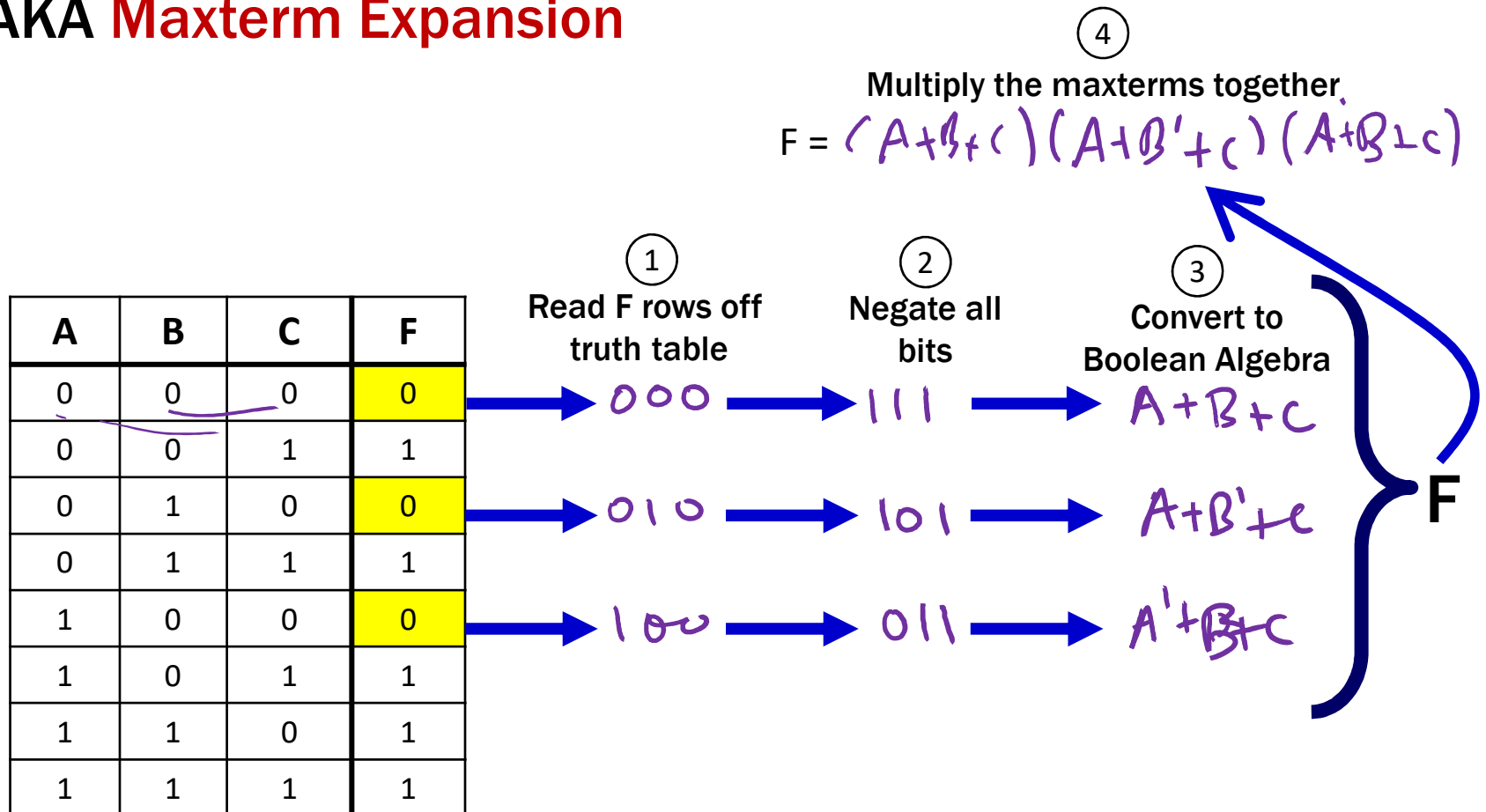

Product-of-Sums Canonical Form

- AKA **Conjunctive Normal Form (CNF)**
- AKA **Maxterm Expansion**

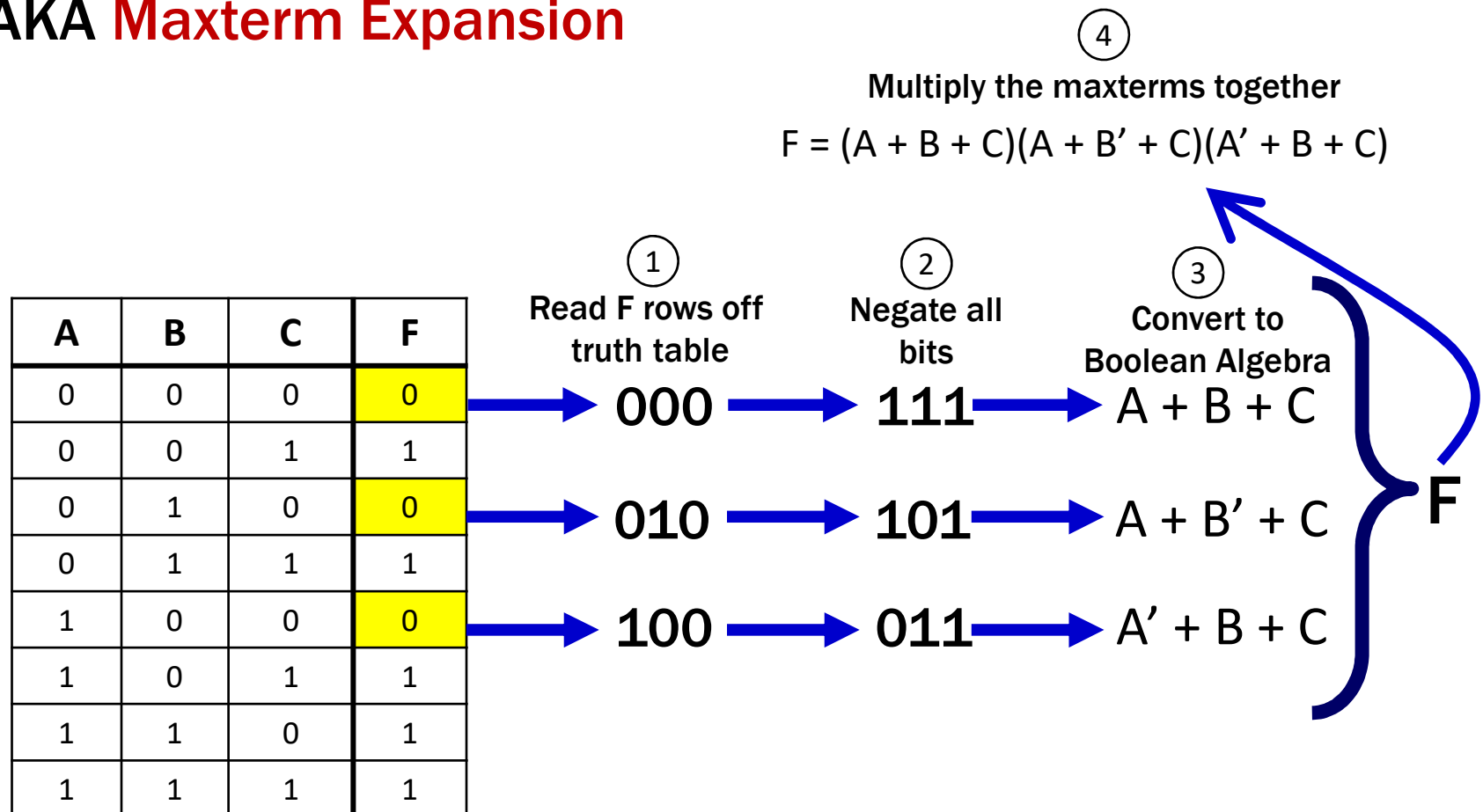

Product-of-Sums: Why does this procedure work?

Useful Facts:

- We know $(F')' = F$
- We know how to get a minterm expansion for F'

A	B	C	F
0	0	0	0
0	0	1	1
0	1	0	0
0	1	1	1
1	0	0	0
1	0	1	1
1	1	0	1
1	1	1	1

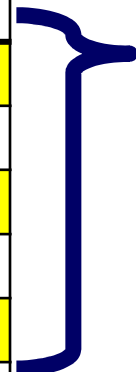
$$F' = A'B'C' + A'BC' + AB'C'$$

Product-of-Sums: Why does this procedure work?

Useful Facts:

- We know $(F')' = F$
- We know how to get a minterm expansion for F'

minterm expansion

A	B	C	F
0	0	0	0
0	0	1	1
0	1	0	0
0	1	1	1
1	0	0	0
1	0	1	1
1	1	0	1
1	1	1	1



$$F' = A'B'C' + A'BC' + AB'C'$$

Taking the complement of both sides...

$$(F')' = (A'B'C' + A'BC' + AB'C')'$$

And using DeMorgan/Comp....

$$F = (A'B'C')' (A'BC')' (AB'C')'$$

$$F = (A + B + C)(A + B' + C)(A' + B + C)$$

Product-of-Sums Canonical Form

Sum term (or maxterm)

- ORed sum of literals – input combination for which output is false
- each variable appears exactly once, true or inverted (but not both)

A	B	C	maxterms
0	0	0	$A+B+C$
0	0	1	$A+B+C'$
0	1	0	$A+B'+C$
0	1	1	$A+B'+C'$
1	0	0	$A'+B+C$
1	0	1	$A'+B+C'$
1	1	0	$A'+B'+C$
1	1	1	$A'+B'+C'$

F in canonical form:

$$F(A, B, C) = (A + B + C) (A + B' + C) (A' + B + C)$$

canonical form \neq minimal form

$$\begin{aligned} F(A, B, C) &= (A + B + C) (A + B' + C) (A' + B + C) \\ &= (A + B + C) (A + B' + C) \\ &\quad (A + B + C) (A' + B + C) \\ &= (A + C) (B + C) \end{aligned}$$

Predicate Logic

- **Propositional Logic**

“If you take the high road and I take the low road then I’ll arrive in Scotland before you.”

- **Predicate Logic**

“All positive integers x , y , and z satisfy $x^3 + y^3 \neq z^3$.”

Predicate Logic

- **Propositional Logic**

- Allows us to analyze complex propositions in terms of their simpler constituent parts (a.k.a. atomic propositions) joined by connectives

- **Predicate Logic**

- Lets us analyze them at a deeper level by expressing how those propositions depend on the objects they are talking about

Predicate Logic

Adds two key notions to propositional logic

– **Predicates**

– **Quantifiers**



Predicates

Predicate

- A function that returns a truth value, e.g.,

Cat(x) ::= “x is a cat”

Prime(x) ::= “x is prime”

HasTaken(x, y) ::= “student x has taken course y”

LessThan(x, y) ::= “x < y”

Sum(x, y, z) ::= “x + y = z”

GreaterThan5(x) ::= “x > 5”

HasNChars(s, n) ::= “string s has length n”

Predicates can have varying numbers of arguments and input types.

Domain of Discourse

For ease of use, we define one “type”/“domain” that we work over. This set of objects is called the “**domain of discourse**”.

For each of the following, what might the domain be?

(1) “x is a cat”, “x barks”, “x ruined my couch”

animals / pets, .

(2) “x is prime”, “x = 0”, “x < 0”, “x is a power of two”

\mathbb{Z} - integers, \mathbb{R} ?, \mathbb{N} - natural #

(3) “student x has taken course y” “x is a pre-req for z”

Domain of Discourse

For ease of use, we define one “type”/“domain” that we work over. This set of objects is called the “**domain of discourse**”.

For each of the following, what might the domain be?

(1) “x is a cat”, “x barks”, “x ruined my couch”

“mammals” or “sentient beings” or “cats and dogs” or ...

(2) “x is prime”, “ $x = 0$ ”, “ $x < 0$ ”, “x is a power of two”

“numbers” or “integers” or “integers greater than 5” or ...

(3) “student x has taken course y” “x is a pre-req for z”

“students and courses” or “university entities” or ...

Quantifiers

We use *quantifiers* to talk about collections of objects.

$$\forall x P(x)$$

$P(x)$ is true **for every** x in the domain

read as "**for all x , P of x** "



$$\exists x P(x)$$

There is an x in the domain for which $P(x)$ is true

read as "**there exists x , P of x** "

~~a ambiguous for any~~

Quantifiers

We use *quantifiers* to talk about collections of objects.

Universal Quantifier (“for all”): $\forall x P(x)$

$P(x)$ is true for **every** x in the domain

read as “**for all x , P of x ”**”

Examples: Are these true?

- $\forall x \text{ Odd}(x)$
- $\forall x \text{ LessThan5}(x)$

Quantifiers

We use *quantifiers* to talk about collections of objects.

Universal Quantifier (“for all”): $\forall x P(x)$

$P(x)$ is true for **every** x in the domain

read as “**for all x , P of x ”**”

Examples: Are these true? It depends on the domain. For example:

	{1, 3, -1, -27}	Integers	Odd Integers
• $\forall x \text{ Odd}(x)$	True	False	True
• $\forall x \text{ LessThan4}(x)$	True	False	False

Quantifiers

We use *quantifiers* to talk about collections of objects.

Existential Quantifier (“exists”): $\exists x P(x)$

There is an x in the domain for which $P(x)$ is true
read as “**there exists x , P of x ”**

Examples: Are these true?

- $\exists x \text{ Odd}(x)$
- $\exists x \text{ LessThan5}(x)$

Quantifiers

We use *quantifiers* to talk about collections of objects.

Existential Quantifier (“exists”): $\exists x P(x)$

There is an x in the domain for which $P(x)$ is true
read as “**there exists x , P of x ”**

Examples: Are these true? It depends on the domain. For example:

• $\exists x \text{ Odd}(x)$

• $\exists x \text{ LessThan4}(x)$

$\{1, 3, -1, -27\}$	Integers	Positive Multiples of 5
True	True	True
True	True	False

Statements with Quantifiers

Just like with propositional logic, we need to define variables (this time **predicates**) before we do anything else. We must also now define a **domain of discourse** before doing anything else.

Domain of Discourse

Positive Integers

Predicate Definitions

Even(x) ::= "x is even" Greater(x, y) ::= "x > y"

Odd(x) ::= "x is odd" Equal(x, y) ::= "x = y"

Prime(x) ::= "x is prime" Sum(x, y, z) ::= "x + y = z"

Statements with Quantifiers

Domain of Discourse

Positive Integers

Predicate Definitions

Even(x) ::= "x is even"

Greater(x, y) ::= "x > y"

Odd(x) ::= "x is odd"

Equal(x, y) ::= "x = y"

Prime(x) ::= "x is prime"

Sum(x, y, z) ::= "x + y = z"

Determine the truth values of each of these statements:

$\exists x \text{ Even}(x)$

T

2

$\forall x \text{ Odd}(x)$

F

$\forall x (\text{Even}(x) \vee \text{Odd}(x))$

T

$\exists x (\text{Even}(x) \wedge \text{Odd}(x))$

F

$\forall x \text{ Greater}(x+1, x)$

T

$\exists x (\text{Even}(x) \wedge \text{Prime}(x))$

T

2

Statements with Quantifiers

Domain of Discourse

Positive Integers

Predicate Definitions

Even(x) ::= "x is even" Greater(x, y) ::= "x > y"

Odd(x) ::= "x is odd" Equal(x, y) ::= "x = y"

Prime(x) ::= "x is prime" Sum(x, y, z) ::= "x + y = z"

Determine the truth values of each of these statements:

- | | | |
|---|----------|--------------------------------------|
| $\exists x \text{ Even}(x)$ | T | e.g. 2, 4, 6, ... |
| $\forall x \text{ Odd}(x)$ | F | e.g. 2, 4, 6, ... |
| $\forall x (\text{Even}(x) \vee \text{Odd}(x))$ | T | every integer is either even or odd |
| $\exists x (\text{Even}(x) \wedge \text{Odd}(x))$ | F | no integer is both even and odd |
| $\forall x \text{ Greater}(x+1, x)$ | T | adding 1 makes a bigger number |
| $\exists x (\text{Even}(x) \wedge \text{Prime}(x))$ | T | Even(2) is true and Prime(2) is true |

Statements with Quantifiers

Domain of Discourse

Positive Integers

Predicate Definitions

Even(x) ::= "x is even" Greater(x, y) ::= "x > y"

Odd(x) ::= "x is odd" Equal(x, y) ::= "x = y"

Prime(x) ::= "x is prime" Sum(x, y, z) ::= "x + y = z"

Translate the following statements to English

"x is not largest!" "There is a larger # than x"

$\forall x \exists y \text{ Greater}(y, x)$

$\forall x \exists y \text{ Greater}(x, y)$

$\forall x \exists y (\text{Greater}(y, x) \wedge \text{Prime}(y))$

$\forall x (\text{Prime}(x) \rightarrow (\text{Equal}(x, 2) \vee \text{Odd}(x)))$

$\exists x \exists y (\text{Sum}(x, 2, y) \wedge \text{Prime}(x) \wedge \text{Prime}(y))$

Statements with Quantifiers (Literal Translations)

Domain of Discourse

Positive Integers

Predicate Definitions

Even(x) ::= "x is even" Greater(x, y) ::= "x > y"

Odd(x) ::= "x is odd" Equal(x, y) ::= "x = y"

Prime(x) ::= "x is prime" Sum(x, y, z) ::= "x + y = z"

Translate the following statements to English

$\forall x \exists y \text{ Greater}(y, x)$

For every positive integer x, there is a positive integer y, such that $y > x$.

$\forall x \exists y \text{ Greater}(x, y)$

For every positive integer x, there is a positive integer y, such that $x > y$.

$\forall x \exists y (\text{Greater}(y, x) \wedge \text{Prime}(y))$

For every positive integer x, there is a pos. int. y such that $y > x$ and y is prime.

$\forall x (\text{Prime}(x) \rightarrow (\text{Equal}(x, 2) \vee \text{Odd}(x)))$

For each positive integer x, if x is prime, then $x = 2$ or x is odd.

$\exists x \exists y (\text{Sum}(x, 2, y) \wedge \text{Prime}(x) \wedge \text{Prime}(y))$

There exist positive integers x and y such that $x + 2 = y$ and x and y are prime.

Statements with Quantifiers (Natural Translations)

Domain of Discourse

Positive Integers

Predicate Definitions

Even(x) ::= "x is even" Greater(x, y) ::= "x > y"

Odd(x) ::= "x is odd" Equal(x, y) ::= "x = y"

Prime(x) ::= "x is prime" Sum(x, y, z) ::= "x + y = z"

Translate the following statements to English

$\forall x \exists y \text{ Greater}(y, x)$

There is no greatest positive integer.

$\forall x \exists y \text{ Greater}(x, y)$

There is no least positive integer.

$\forall x \exists y (\text{Greater}(y, x) \wedge \text{Prime}(y))$

For every positive integer there is a larger number that is prime.

$\forall x (\text{Prime}(x) \rightarrow (\text{Equal}(x, 2) \vee \text{Odd}(x)))$

Every prime number is either 2 or odd.

$\exists x \exists y (\text{Sum}(x, 2, y) \wedge \text{Prime}(x) \wedge \text{Prime}(y))$

There exist prime numbers that differ by two."

English to Predicate Logic

Domain of Discourse

Mammals

Predicate Definitions

$\text{Cat}(x) ::= \text{"x is a cat"}$

$\text{Red}(x) ::= \text{"x is red"}$

$\text{LikesTofu}(x) ::= \text{"x likes tofu"}$

"Red cats like tofu"

"Some red cats don't like tofu"

English to Predicate Logic

Domain of Discourse

Mammals

Predicate Definitions

Cat(x) ::= "x is a cat"

Red(x) ::= "x is red"

LikesTofu(x) ::= "x likes tofu"

"Red cats like tofu"

$\forall x ((\text{Red}(x) \wedge \text{Cat}(x)) \rightarrow \text{LikesTofu}(x))$

"Some red cats don't like tofu"

$\exists y ((\text{Red}(y) \wedge \text{Cat}(y)) \wedge \neg \text{LikesTofu}(y))$

English to Predicate Logic

Domain of Discourse

Mammals

Predicate Definitions

Cat(x) ::= "x is a cat"

Red(x) ::= "x is red"

LikesTofu(x) ::= "x likes tofu"

When putting two predicates together like this, we use an "and".

"Red cats like tofu"

When restricting to a smaller domain in a "for all" we use implication.

When there's no leading quantification, it means "for all".

"Some red cats don't like tofu"

When restricting to a smaller domain in an "exists" we use and.

"Some" means "there exists".

Negations of Quantifiers

Predicate Definitions

PurpleFruit(x) ::= “x is a purple fruit”

(*) $\forall x$ PurpleFruit(x) (“All fruits are purple”)

What is the negation of (*)?

- (a) “there exists a purple fruit”
- (b) “there exists a non-purple fruit”
- (c) “all fruits are not purple”

Try your intuition! Which one “feels” right?

Key Idea: In **every** domain, exactly one of a statement and its negation should be true.

Negations of Quantifiers

Predicate Definitions

PurpleFruit(x) ::= “x is a purple fruit”

(*) $\forall x$ PurpleFruit(x) (“All fruits are purple”)

What is the negation of (*)?

- (a) “there exists a purple fruit”
- (b) “there exists a non-purple fruit”
- (c) “all fruits are not purple”

Key Idea: In **every** domain, exactly one of a statement and its negation should be true.

Domain of Discourse

{plum}

Domain of Discourse

{apple}

Domain of Discourse

{plum, apple}

The only choice that ensures exactly one of the statement and its negation is (b).

De Morgan's Laws for Quantifiers

$$\neg \forall x P(x) \equiv \exists x \neg P(x)$$

$$\neg \exists x P(x) \equiv \forall x \neg P(x)$$

De Morgan's Laws for Quantifiers

$$\neg \forall x P(x) \equiv \exists x \neg P(x)$$

$$\neg \exists x P(x) \equiv \forall x \neg P(x)$$

“There is no largest integer”

$$\neg \exists x \forall y (x \geq y)$$

$$\equiv \forall x \neg \forall y (x \geq y)$$

$$\equiv \forall x \exists y \neg (x \geq y)$$

$$\equiv \forall x \exists y (x < y)$$

“For every integer there is a larger integer”

Scope of Quantifiers

$\exists x (P(x) \wedge Q(x))$ **vs.** $\exists x P(x) \wedge \exists x Q(x)$

Scope of Quantifiers

$$\exists x (P(x) \wedge Q(x)) \quad \text{vs.} \quad \exists x P(x) \wedge \exists x Q(x)$$

This one asserts P
and Q of the *same* x.

This one asserts P and Q
of potentially different x's.

Scope of Quantifiers

Example: $\text{NotLargest}(x) \equiv \exists y \text{ Greater}(y, x)$
 $\equiv \exists z \text{ Greater}(z, x)$

truth value:

doesn't depend on y or z “**bound** variables”

does depend on x “**free** variable”

quantifiers only act on free variables of the formula
they quantify

$$\forall x (\exists y (P(x, y) \rightarrow \forall x Q(y, x)))$$

Quantifier “Style”

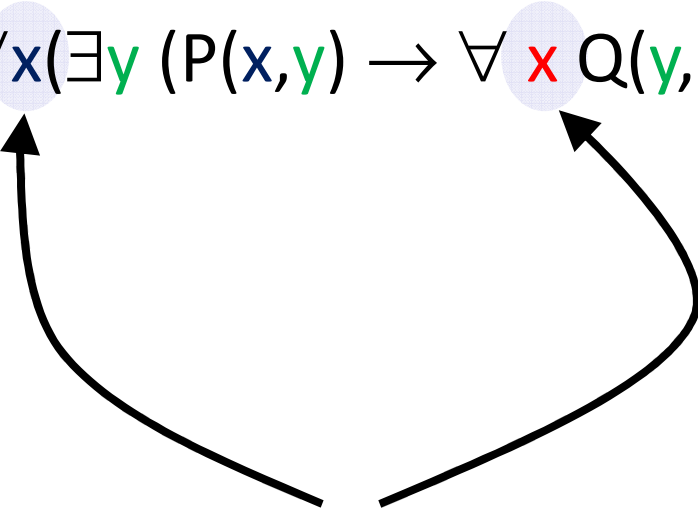
$$\forall x(\exists y (P(x,y) \rightarrow \forall x Q(y, x)))$$

This isn't “wrong”, it's just horrible style.
Don't confuse your reader by using the same variable multiple times...there are a lot of letters...