

CSE 512 - Data Visualization

Evaluation

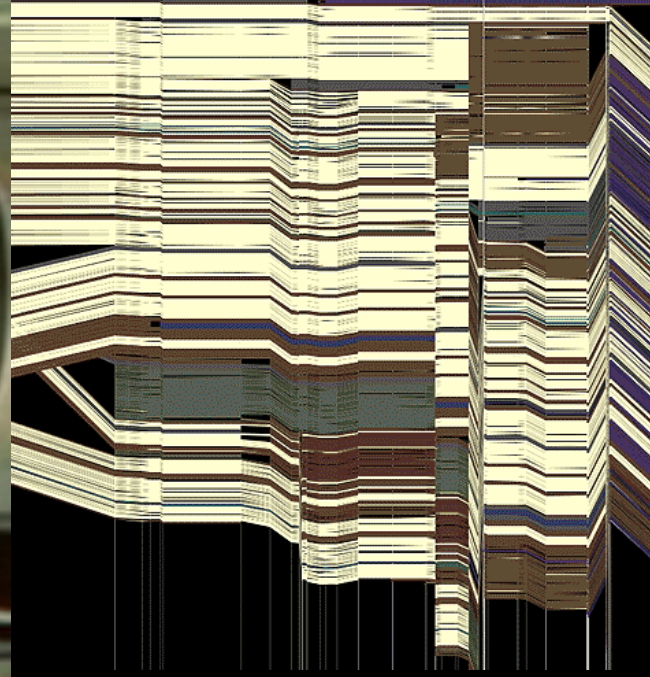
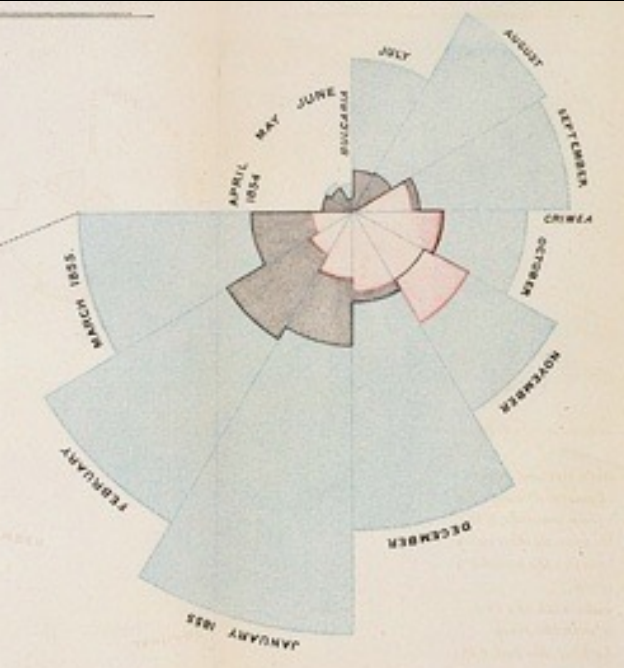

Jeffrey Heer University of Washington

How do we determine if a
visualization is *effective*?

Example: Tree Browsers

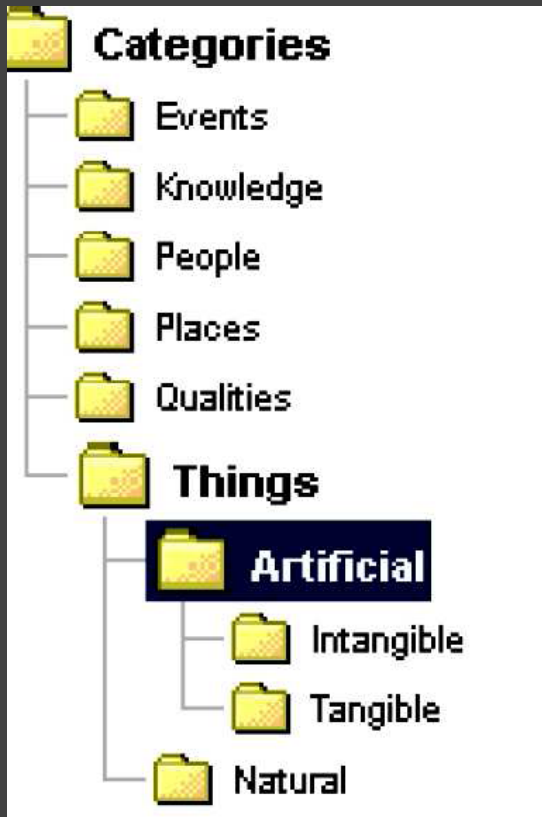

VS.

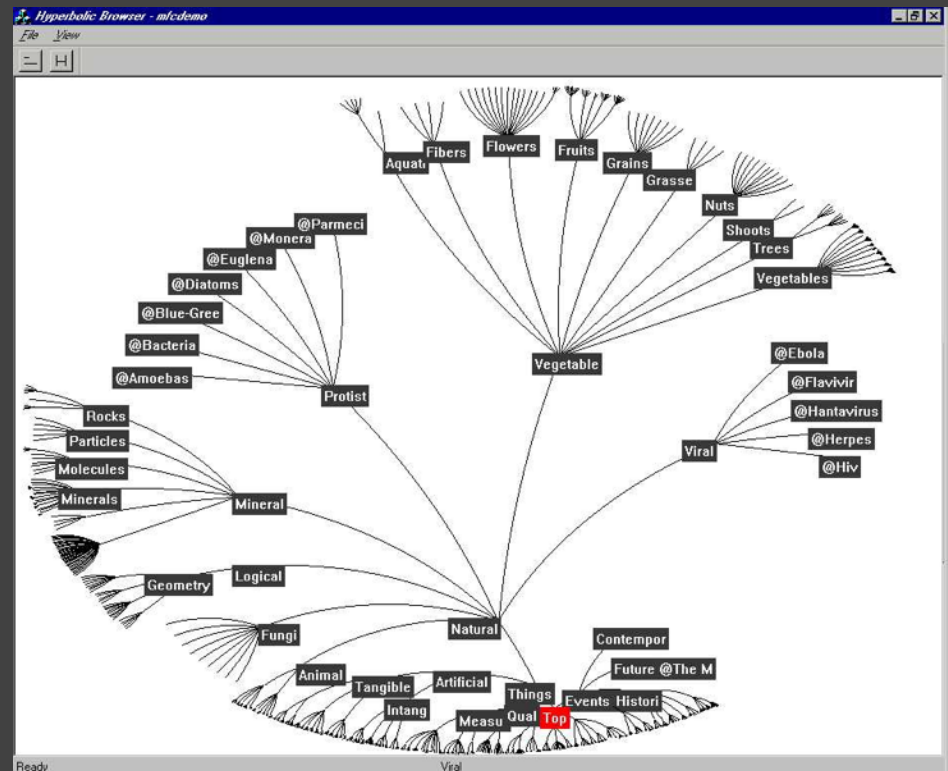

Evaluation Methods

Inspection or Principled Rationale

Apply design heuristics, perceptual principles

Informal User Study

Have people use visualization, observe results

Controlled Experiment

Choose appropriate tasks / users to compare

Choose metrics (time, error, **what else?**)

Evaluation Methods

Field Deployment or Case Studies

Observation and Interview

Document effects on work practices

Theoretical Analysis

Algorithm time and space complexity

Benchmarks

Performance (e.g., interactive frame rates)

Scalability to larger data sets

Topics

Focus+Context Methods (Trees, Spatial Navigation)

Data Density of Time Series

Perceptual Organization of Graphs

Contextual Effects on Visualization Use

Discussion and Course Evaluation

Trees

The Great Browse-Off! [CHI 97]

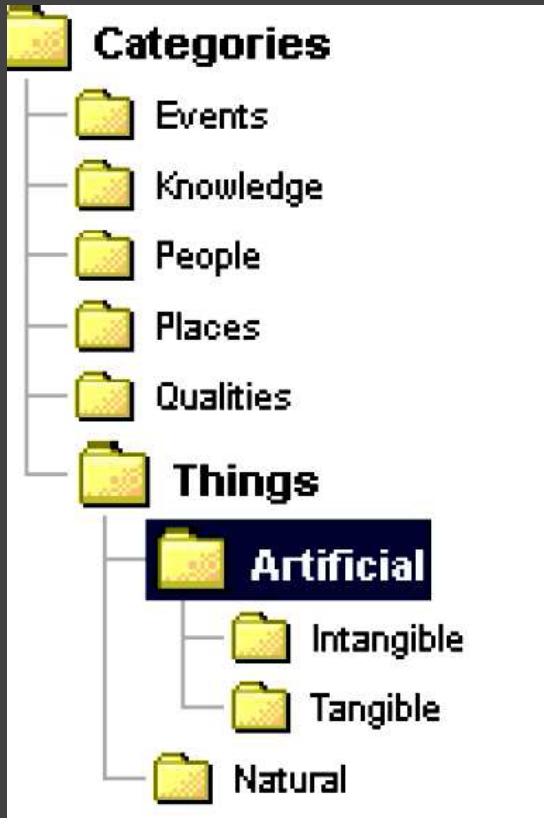

Microsoft File Explorer

VS.

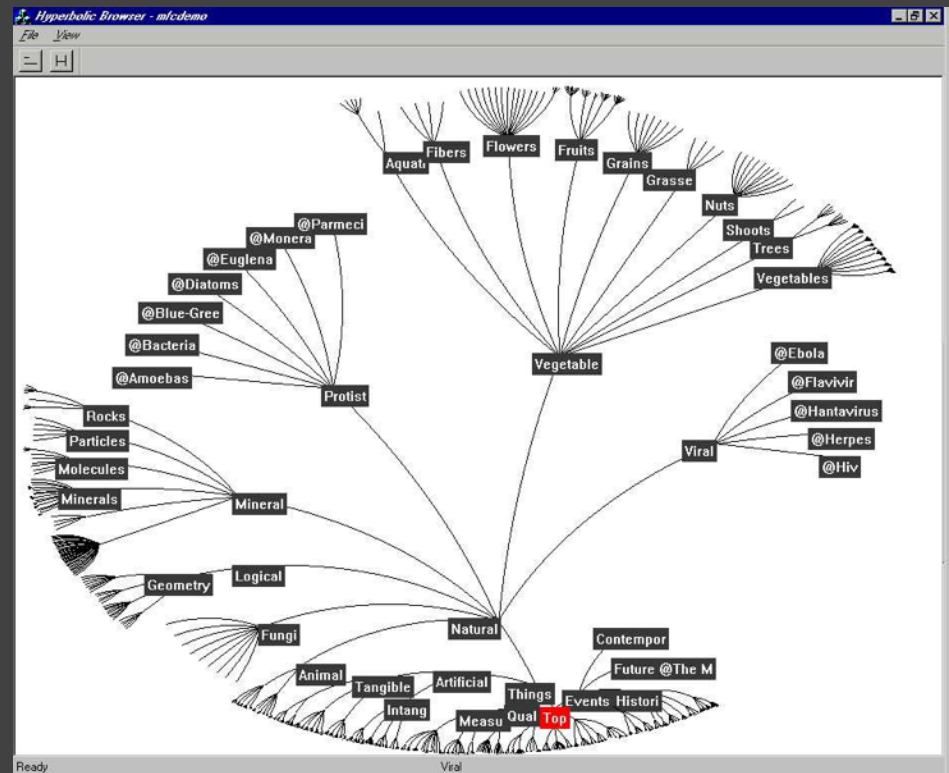

Xerox PARC Hyperbolic Tree

Which visualization is better?

Which visualization is better?

Xerox PARC researchers ran eye-tracking studies to investigate... [Pirolli et al 00]

Which visualization is better?

Xerox PARC researchers ran eye-tracking studies to investigate... [Pirolli et al 00]

Subjects performed both retrieval and comparison tasks of varying complexity.

Which visualization is better?

Xerox PARC researchers ran eye-tracking studies to investigate... [Pirolli et al 00]

Subjects performed both retrieval and comparison tasks of varying complexity.

No significant performance differences were found across task conditions.

How do users navigate the tree?

How do users navigate the tree?

They read the labels!

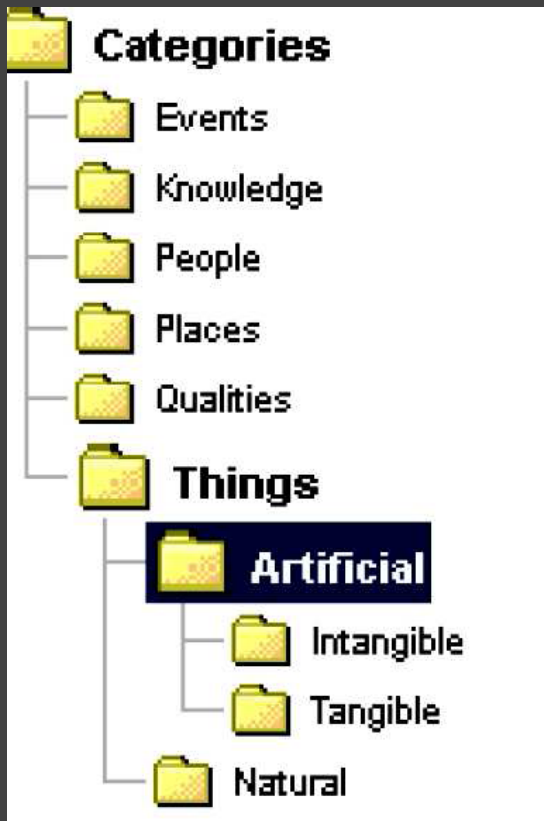

Microsoft File Explorer

VS.

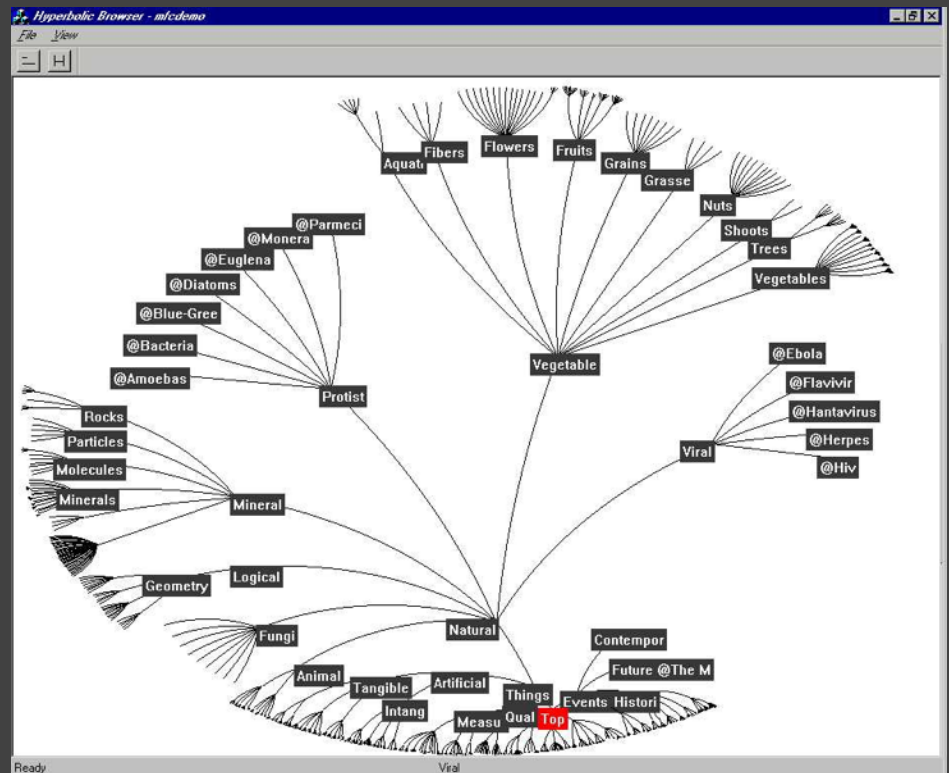

Xerox PARC Hyperbolic Tree

How do users navigate the tree?

Information Scent: A user's (imperfect) perception of the value, cost, or access path of information sources obtained from proximal cues. [Pirolli & Card 99]

How do users navigate the tree?

Information Scent: A user's (imperfect) perception of the value, cost, or access path of information sources obtained from proximal cues. [Pirolli & Card 99]

Operationalize as: the proportion of participants who correctly identified the location of the task answer from looking at upper branches in the tree.

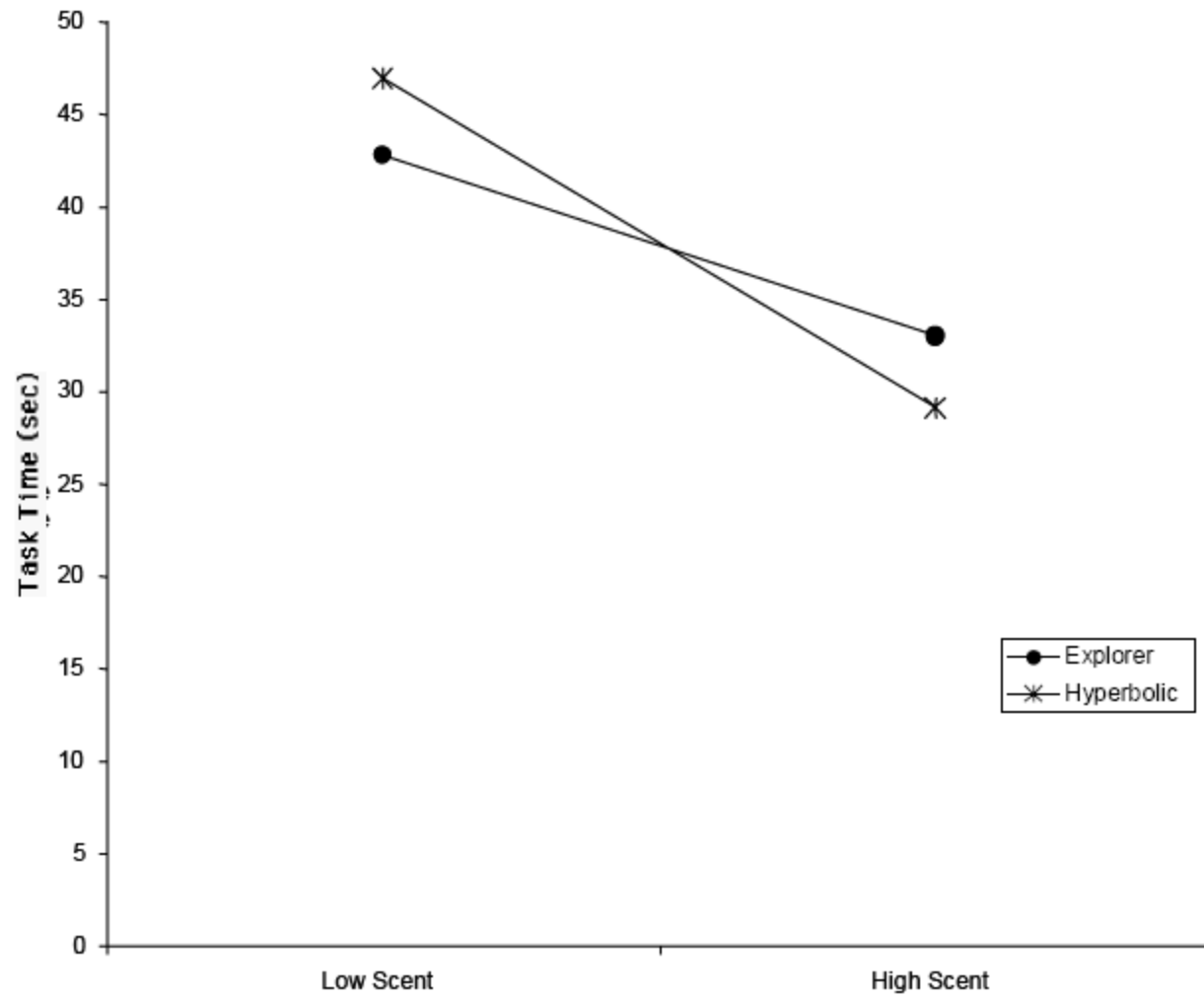

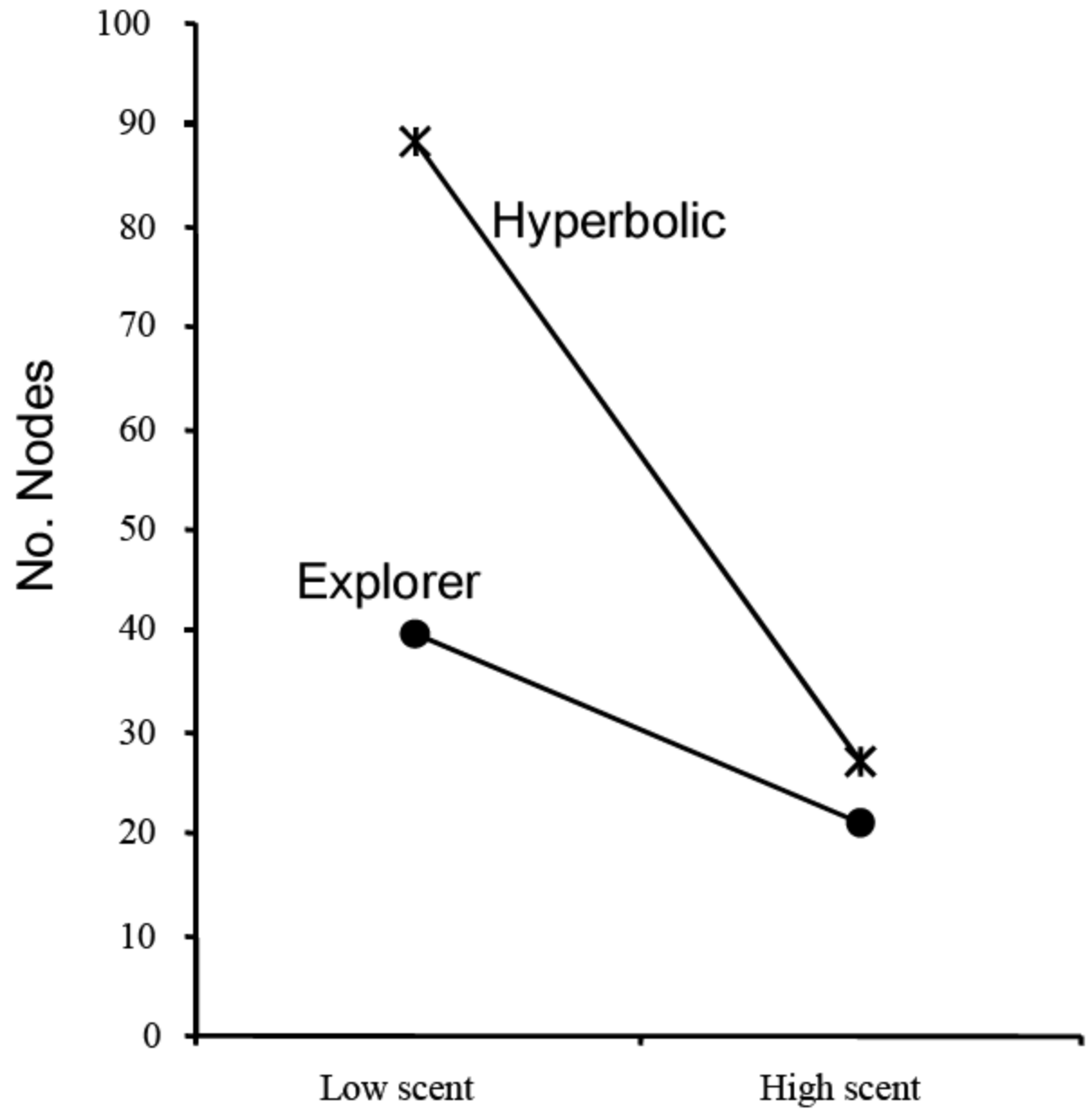

Length of Eye Movements

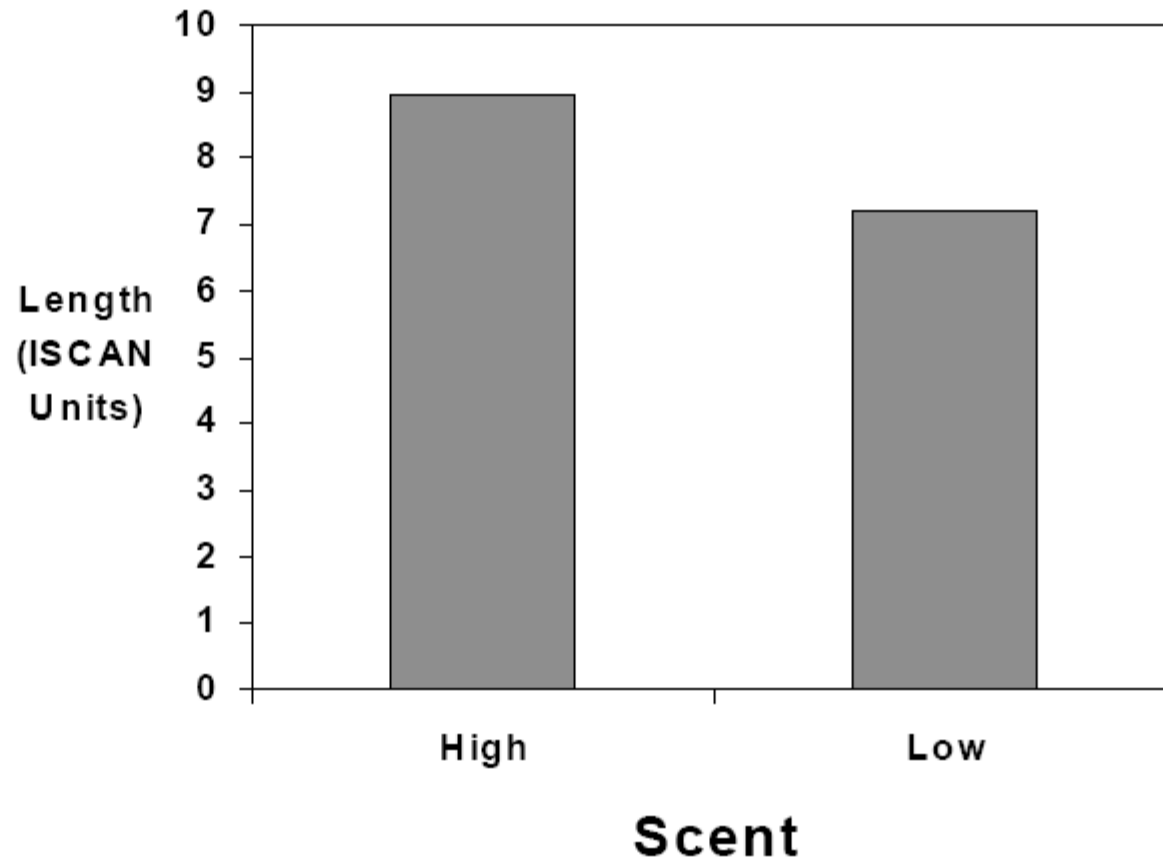

An Adaptive Field of View?

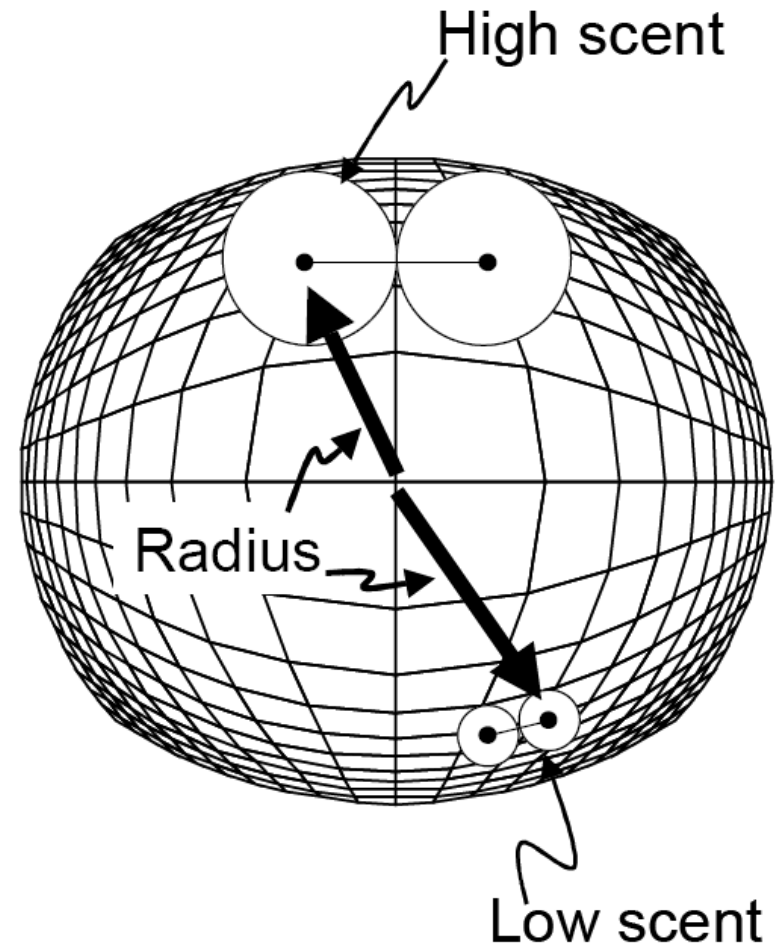
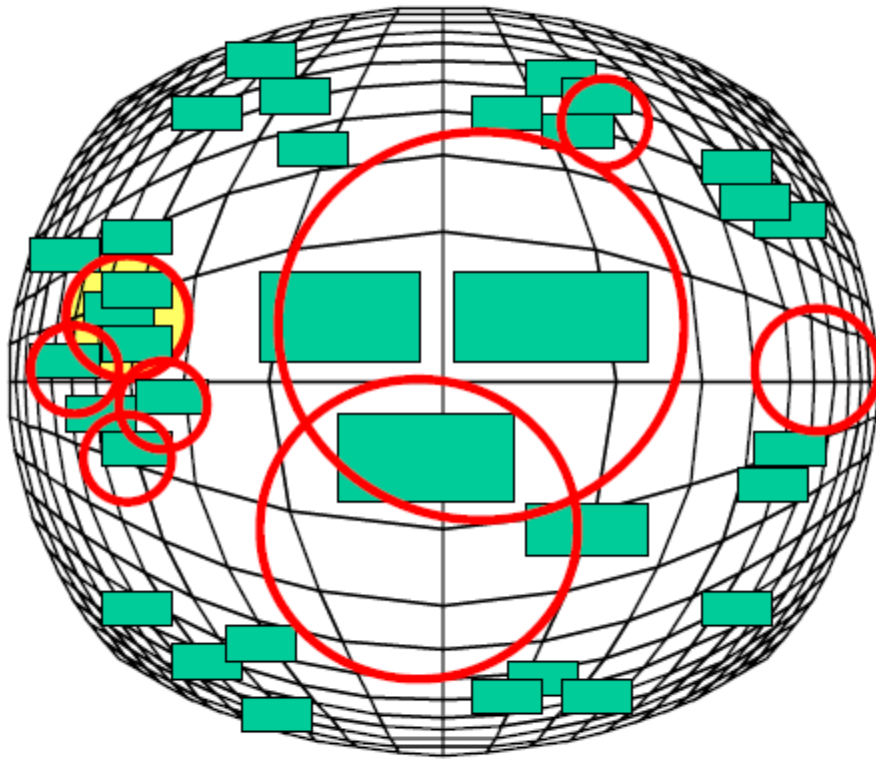

More Evaluations

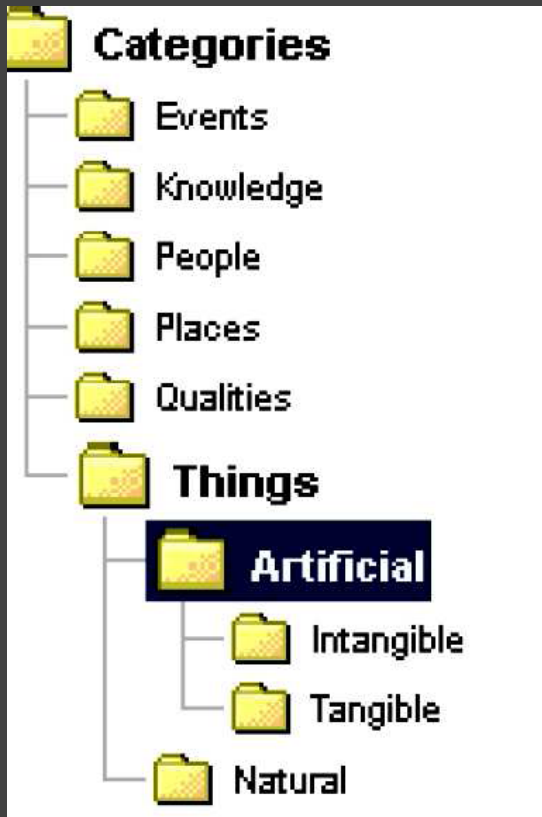

vs.

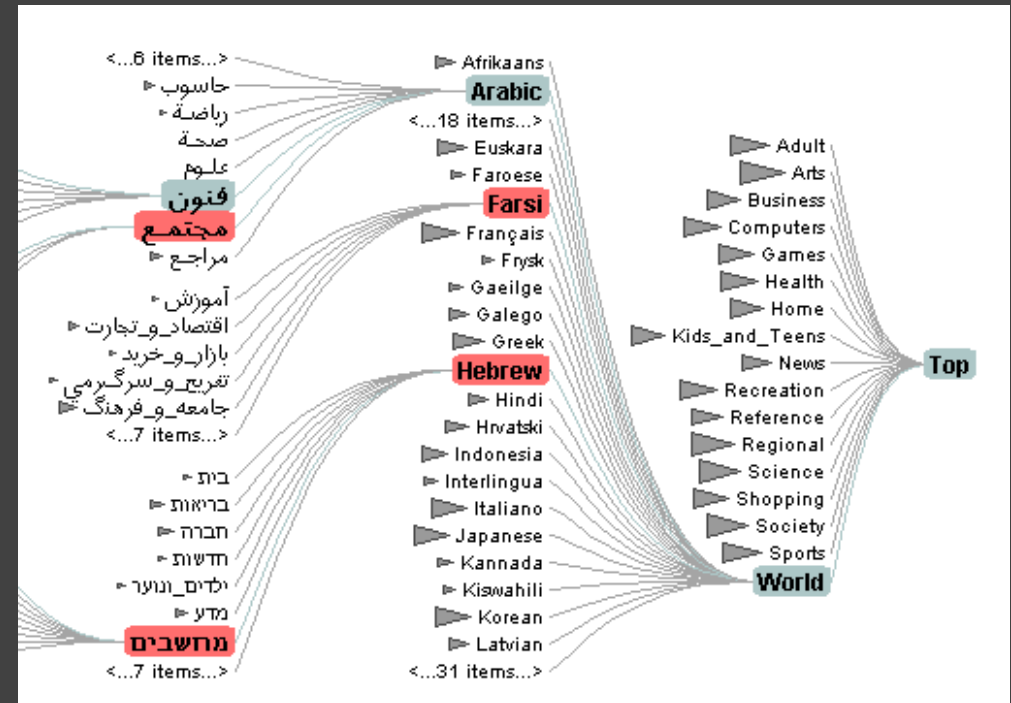

Evaluation of DOI Trees

DOI Tree vs. Windows Explorer [Budiu, AVI 06]

Nodes visited (avg)	DOI:83	Exp:53	$p < .005$
Revisitation (avg)	DOI:6.6	Exp:8.2	$p < .005$
Divergence (avg)	DOI:4.6	Exp:3.9	$p < .001$

DOI Tree more forgiving to navigation errors

BUT no significant difference in task time

DOI Tree vs. Google Directory [Pirolli, CHI 06]

DOI Tree has superior task knowledge transfer

Design Guidelines

Design Guidelines

Support rapid visual scanning

Most people don't read in circles!

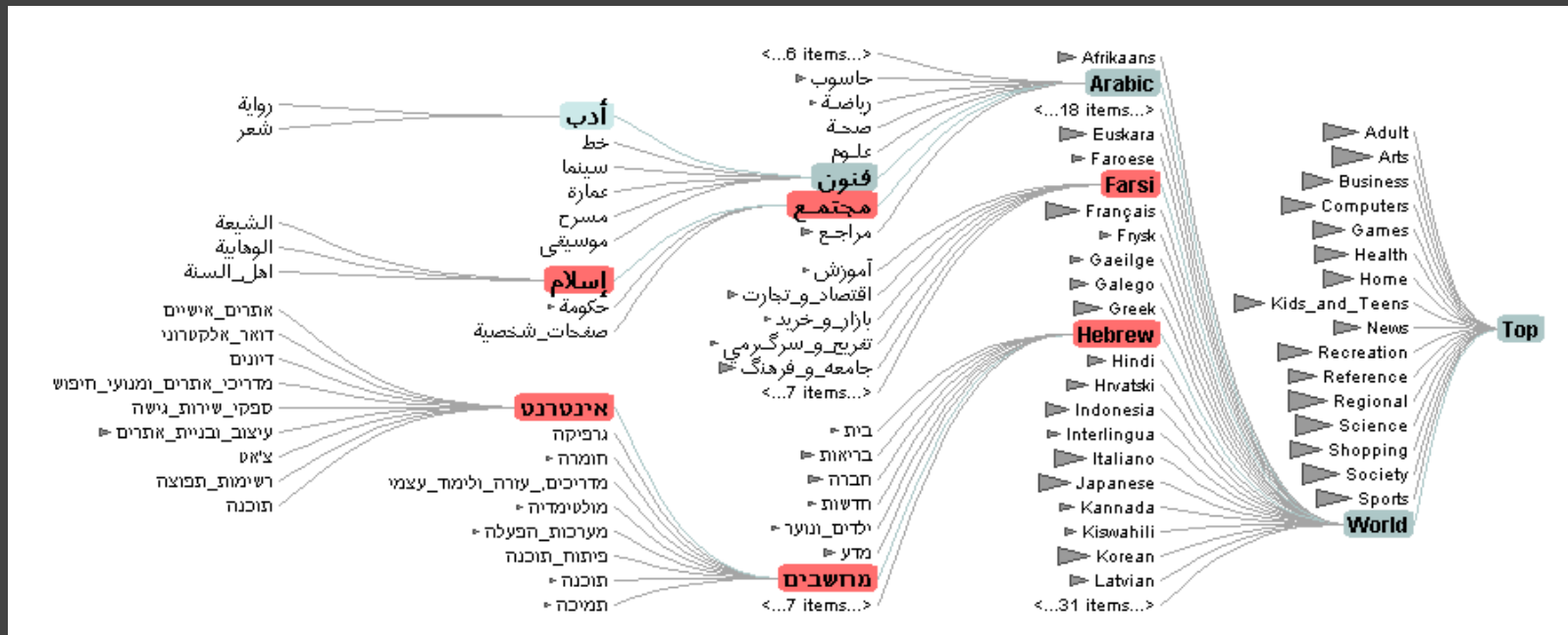

Design Guidelines

People don't read in circles!

Showing more is not always better

Distractors can decrease task performance

Interaction with quality of **information scent**

Design Guidelines

People don't read in circles!

Showing more is not always better

Navigation cues critical to search

Informative labels or landmarks needed

Poor **information scent** undermines search

Lessons Learned

Both **task** and **data properties** (here, *information scent*) may interact with the visualization type in unexpected ways.

Equal **performance** in terms of accuracy or response time is **not the whole picture**.
We often require more detailed study!

Spatial Navigation

An Evaluation of Pan & Zoom and Rubber Sheet Navigation with and without an Overview

Dmitry Nekrasovski, Adam Bodnar, Joanna McGrenere,
François Guimbretière, Tamara Munzner

Pan & Zoom vs. Rubber Sheet

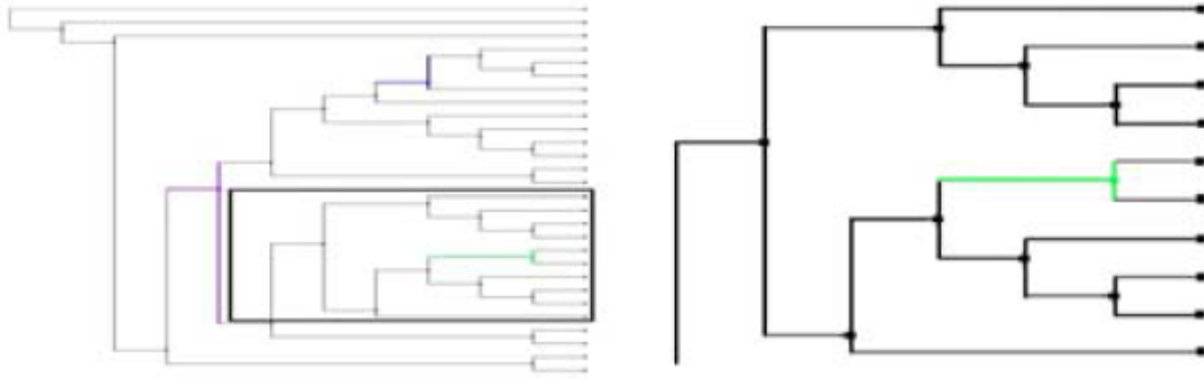

(i) PZN

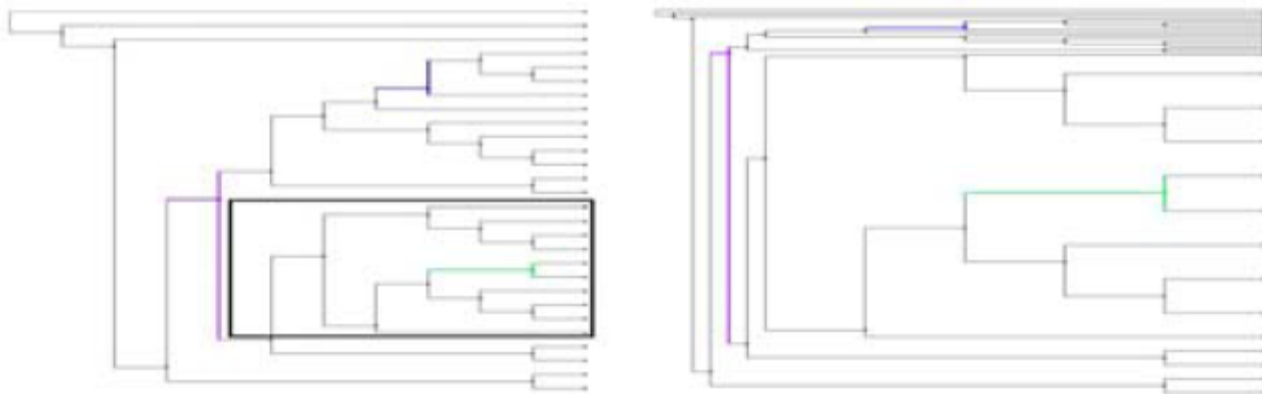

(ii) RSN

Experimental Task

Compare topological distance between nodes in a dendrogram.

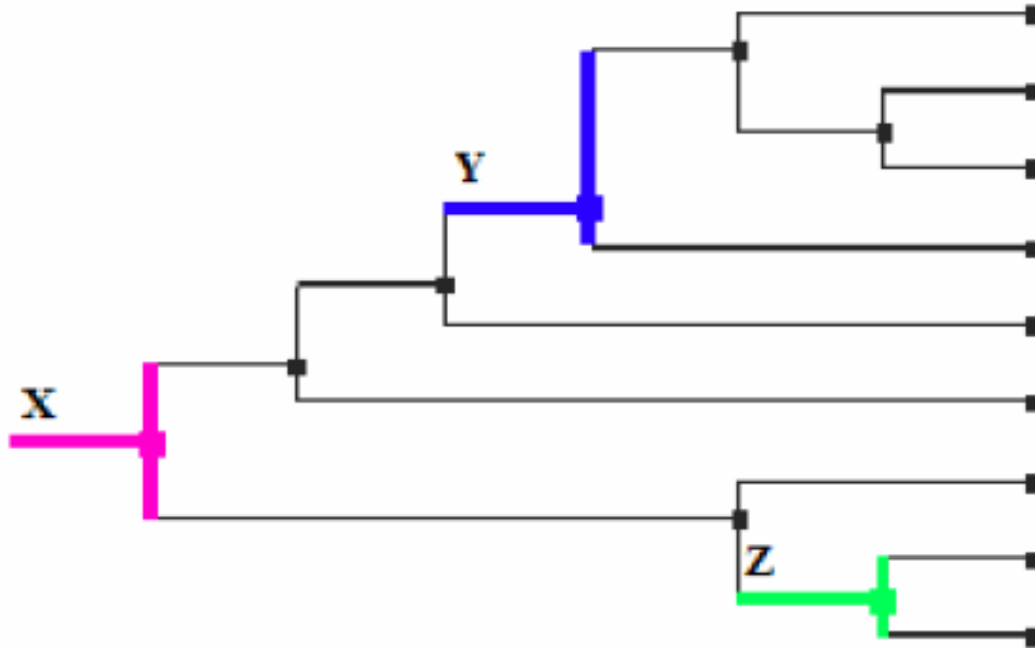

Experiment

Compare performance in 4 conditions:

1. Pan & Zoom (no overview)
2. Pan & Zoom (with overview)
3. Rubber Sheet (no overview)
4. Rubber Sheet (with overview)

40 subjects (24F/16M), between 18-39 years old.

Right-handed, normal vision.

Between-subjects design.

1. Rubber Sheet / No Overview

Evaluation13.gib, CL, level = 8
File Edit Tools Help

Which node is the purple node closer to in terms of topological distance?

Blue Green

Drag with LEFT mouse button to ZOOM IN
Drag with RIGHT mouse button to PAN
Press R to RESET the visualization
Press ESCAPE to CLEAR the current mouse drag

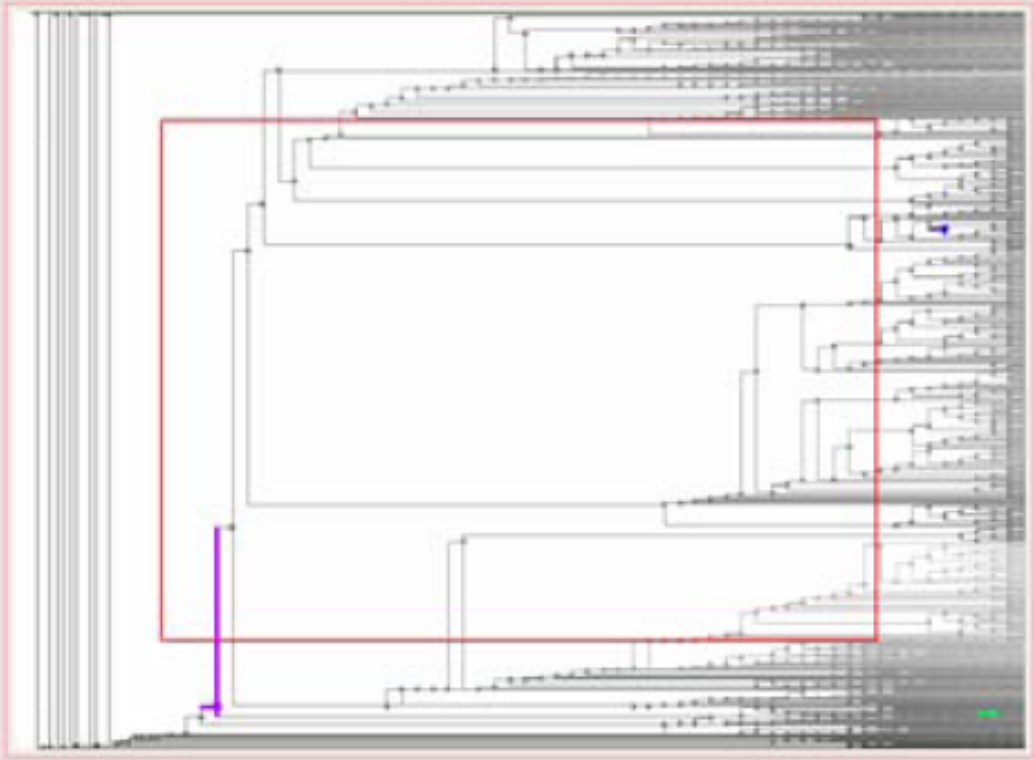

The image shows a complex network graph visualization within a software window. The graph consists of numerous nodes and edges, forming a dense, interconnected structure. A red rectangular bounding box highlights a specific region of the graph, which appears to be a large, roughly rectangular cluster of nodes and edges. Within this red box, a purple node is visible at the bottom left corner. The graph is rendered in a grayscale style with black lines for edges and small circles for nodes. The software window has a standard menu bar at the top with 'File', 'Edit', 'Tools', and 'Help'. Below the menu bar, there is a title bar that reads 'Evaluation13.gib, CL, level = 8'. The main content area of the window contains the graph visualization and a question: 'Which node is the purple node closer to in terms of topological distance?'. Below the question are two radio buttons labeled 'Blue' and 'Green', and a 'Submit' button. On the left side of the window, there are instructions: 'Drag with LEFT mouse button to ZOOM IN', 'Drag with RIGHT mouse button to PAN', 'Press R to RESET the visualization', and 'Press ESCAPE to CLEAR the current mouse drag'.

2. Pan & Zoom / No Overview

EvolutionT3.gp, C2, level = 8

File Edit View Help

Which node is the purple node closer to in terms of topological distance?

Blue Green

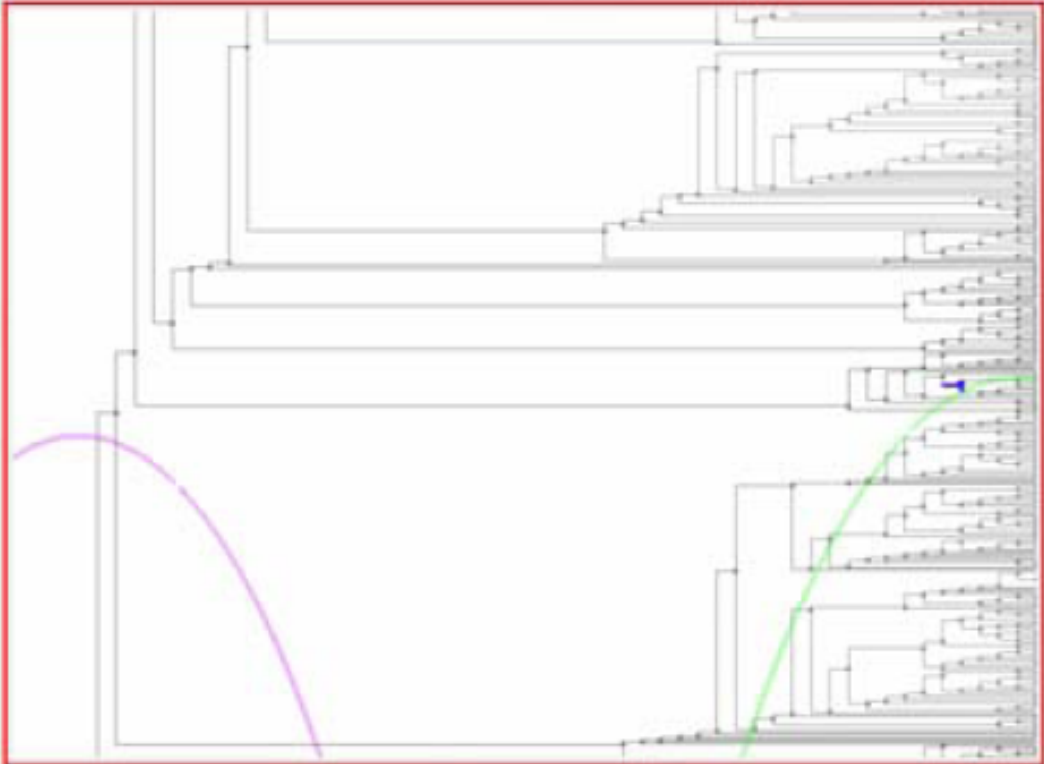

Drag with LEFT mouse button to ZOOM IN
Drag with MIDDLE mouse button to ZOOM OUT
Drag with RIGHT mouse button to PAN

Press R to RESET the visualization
Press ESCAPE to CLEAR the current mouse drag

3. Rubber Sheet / Overview

Evaluation 1.1 pt, C3, level = 3
File Edit View Help

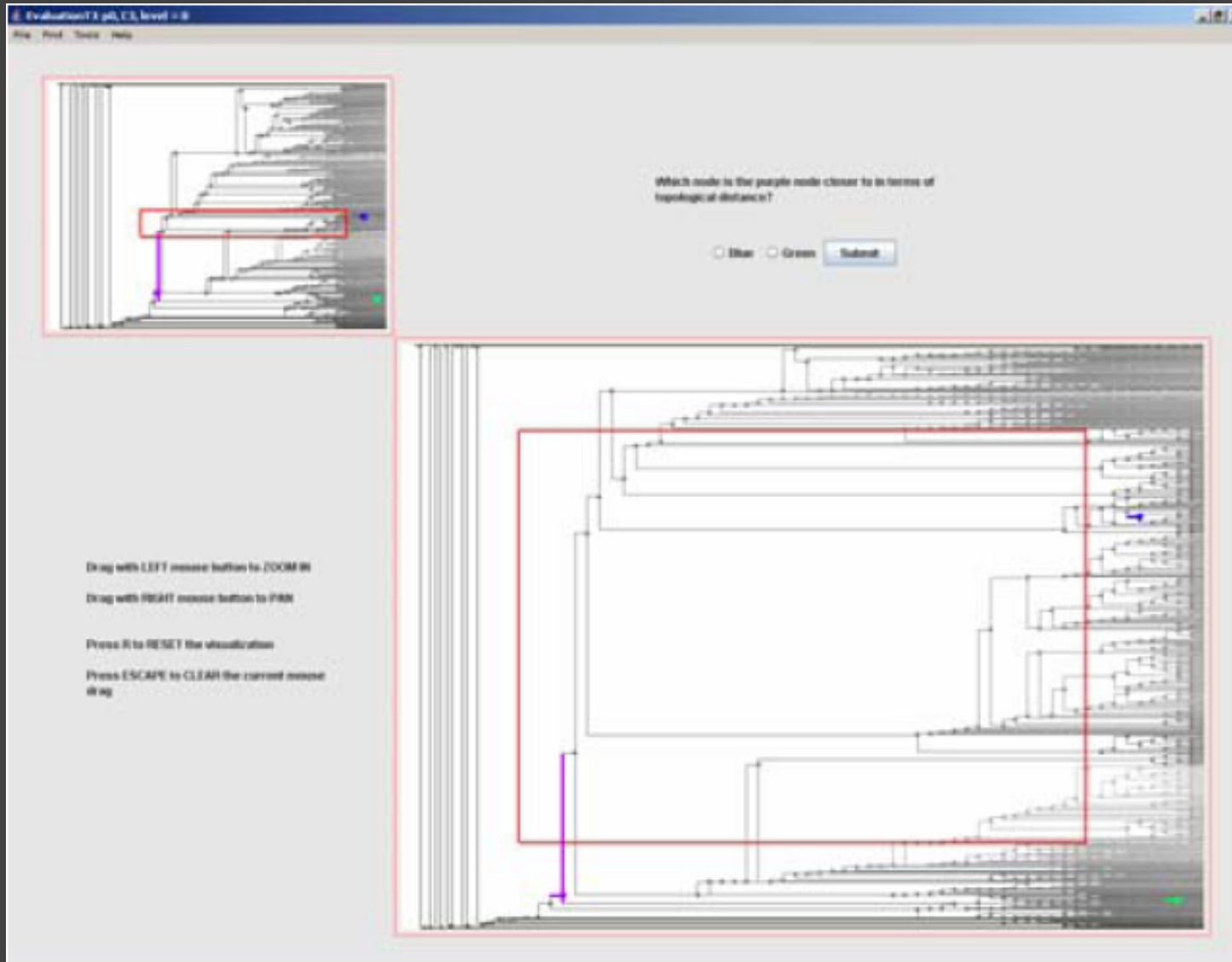

Which node is the purple node closer to in terms of topology or distance?

Blue Green

Drag with LEFT mouse button to ZOOM IN
Drag with RIGHT mouse button to PAN
Press R to RESET the visualization
Press ESCAPE to CLEAR the current mouse drag

4. Pan & Zoom / Overview

Evolution 3 pt, CA, level = 9
File Edit View Help

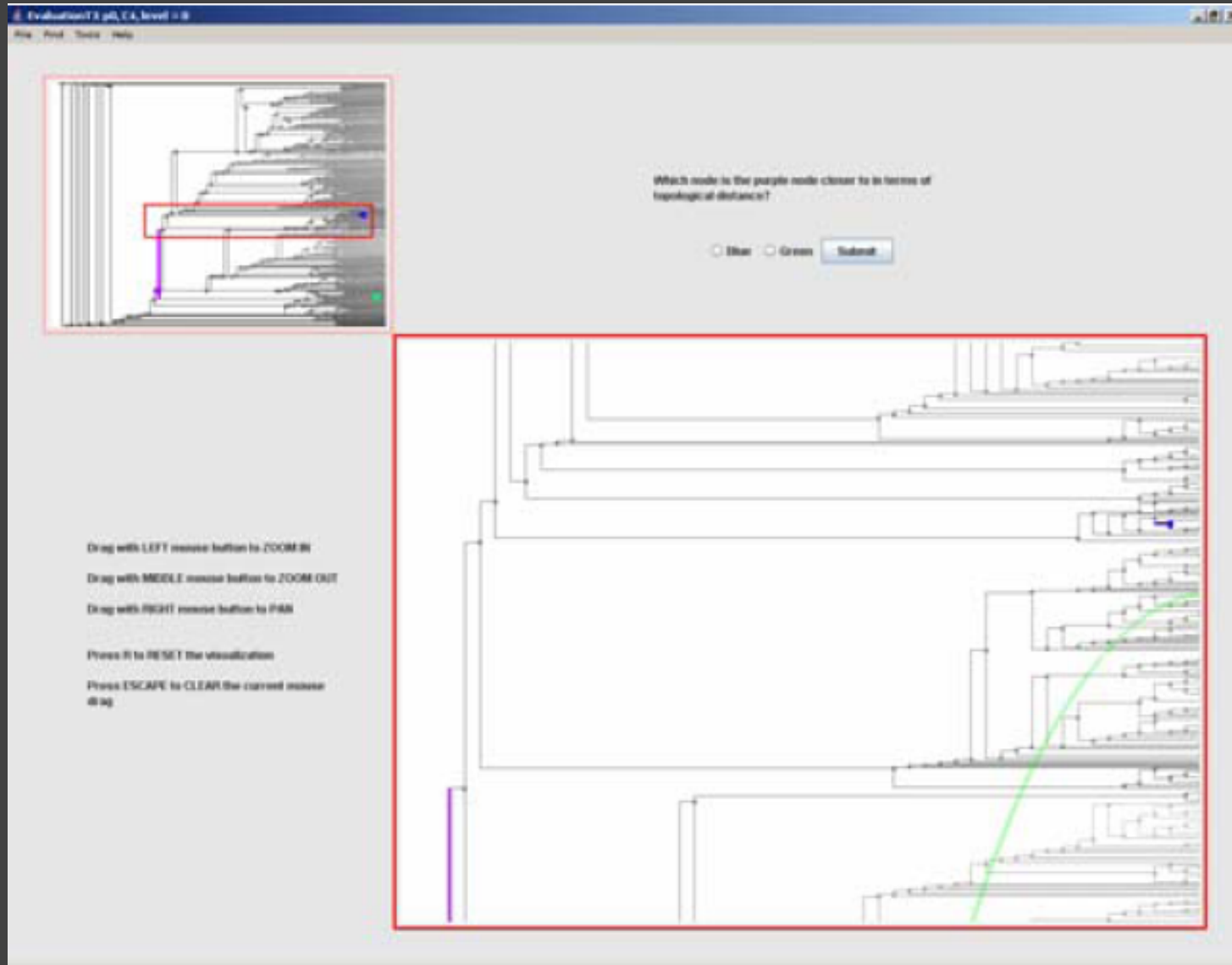

Which node is the purple node closer to in terms of topology or distance?

Blue Green

Drag with LEFT mouse button to ZOOM IN
Drag with MIDDLE mouse button to ZOOM OUT
Drag with RIGHT mouse button to PAN
Press R to RESET the visualization
Press ESCAPE to CLEAR the current mouse drag

Hypotheses

1. RSN interfaces perform better than PZN interfaces independently of the presence or absence of an overview.
2. For RSN, the presence of an overview does not result in better performance.
3. For PZN, the presence of an overview results in better performance.

Results: H1 False

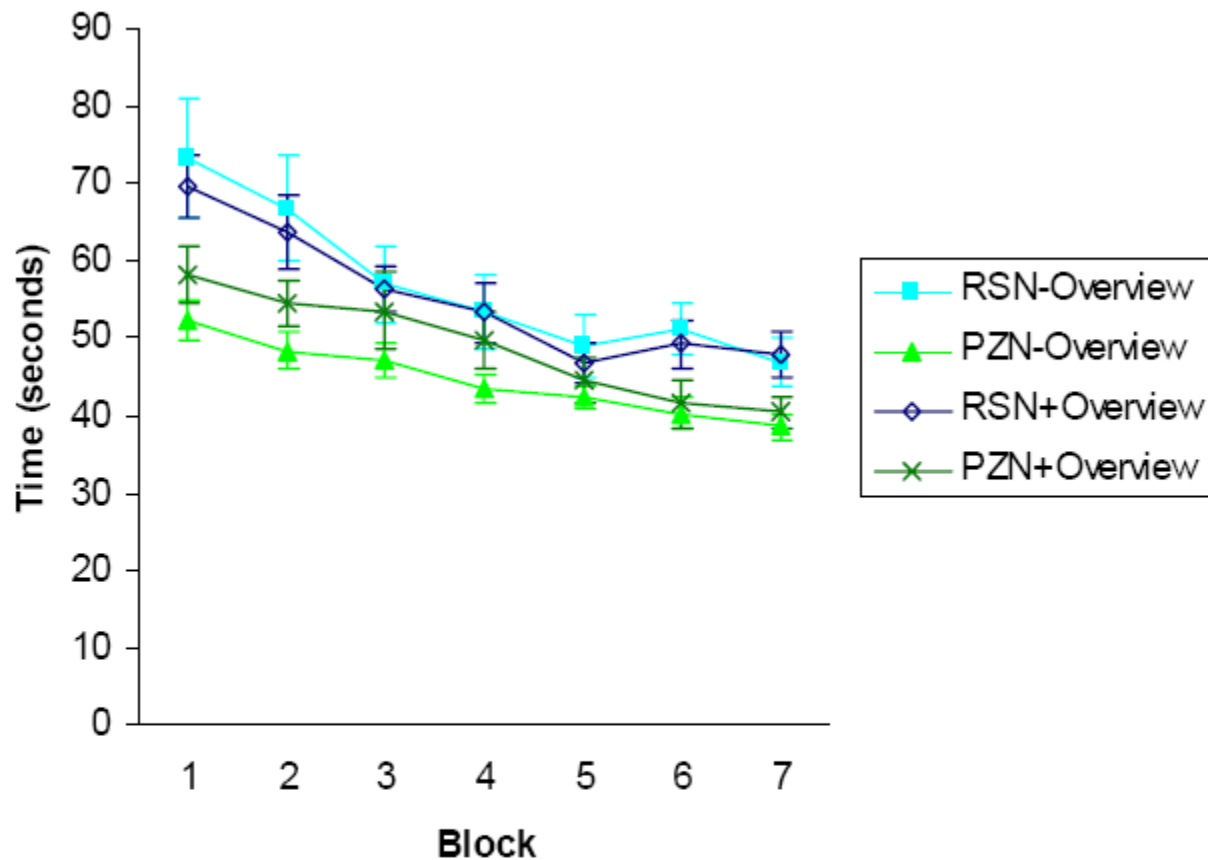

Figure 7: Mean completion times per trial for each interface by block in seconds (N=40).

Results: H2 True, H3 False

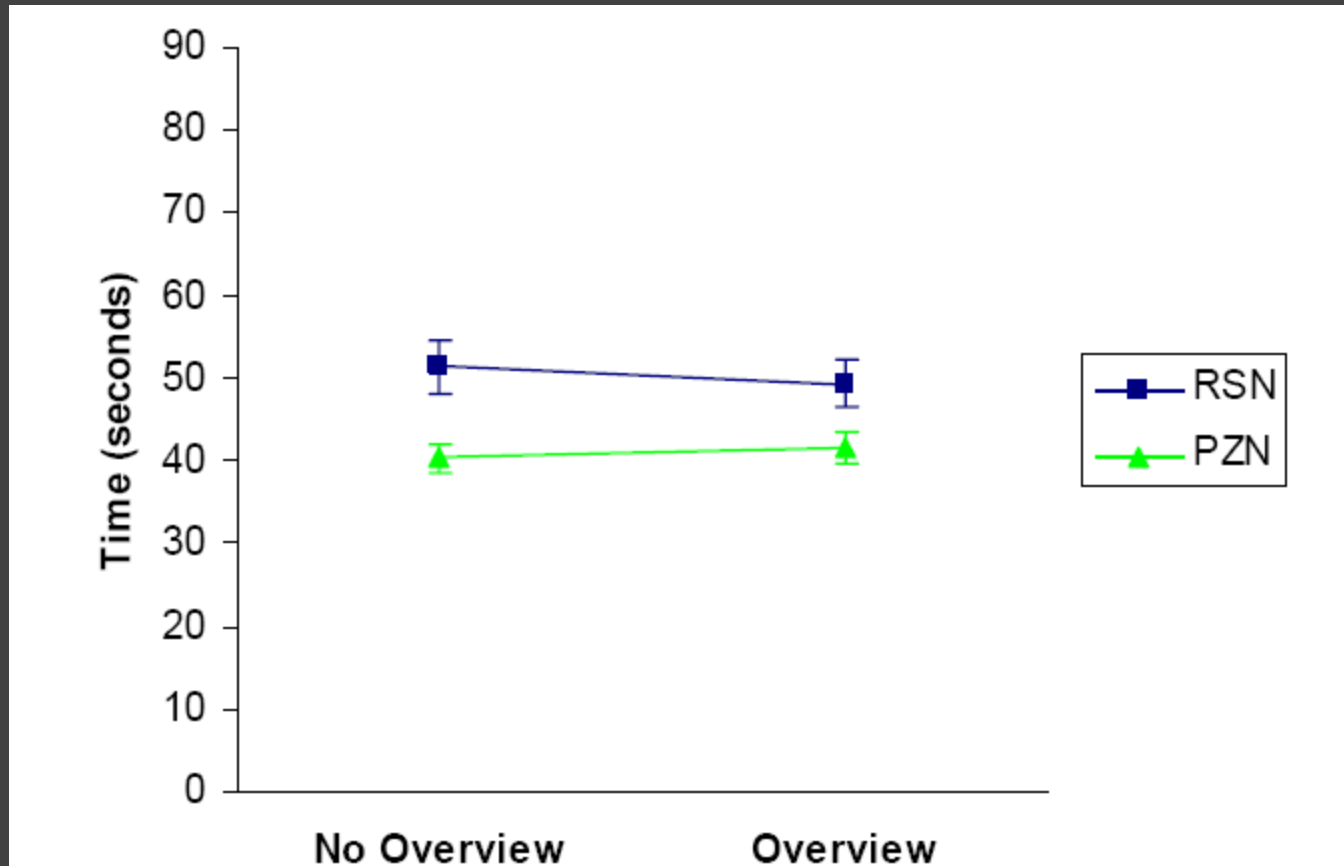

Figure 9: Block 7 mean per-trial completion times in seconds by navigation technique with and without an overview.

Results

R1. Pan & Zoom had lower completion times, navigation actions, resets, and reported mental demand.

R2. Overview has no significant impact on rubber sheet navigation, though it was reported to reduce physical demand.

R3. Overview has no significant impact on pan & zoom navigation, though it was reported to reduce physical demand.

Thoughts?

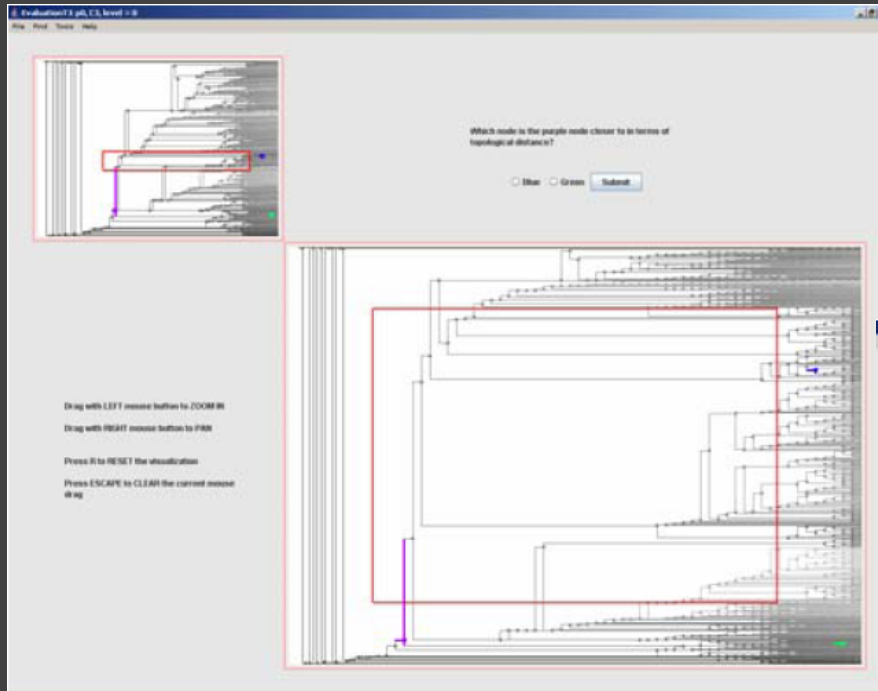

Does this generalize for overview displays?

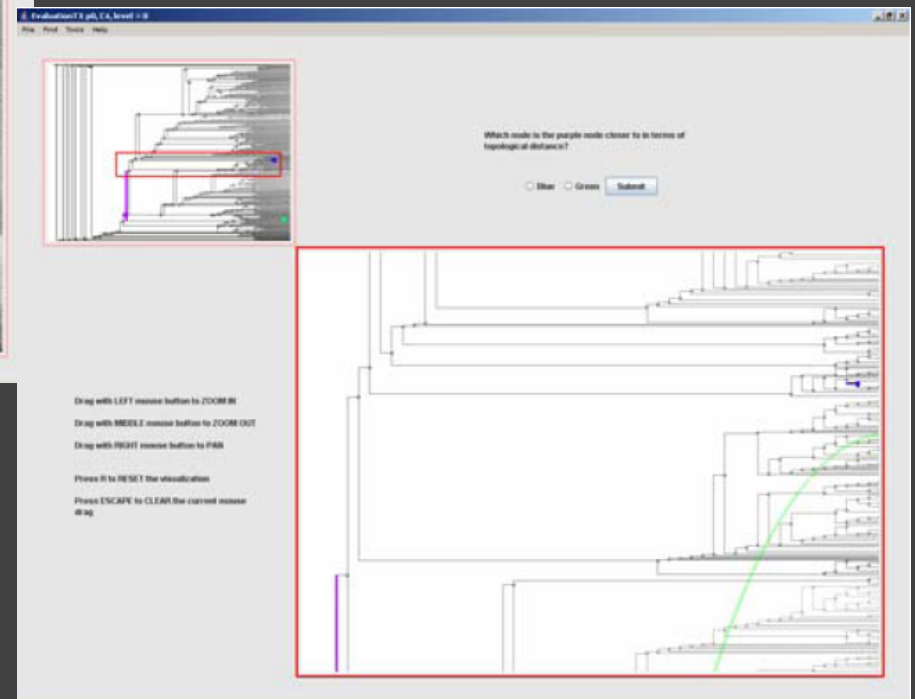

Data Density

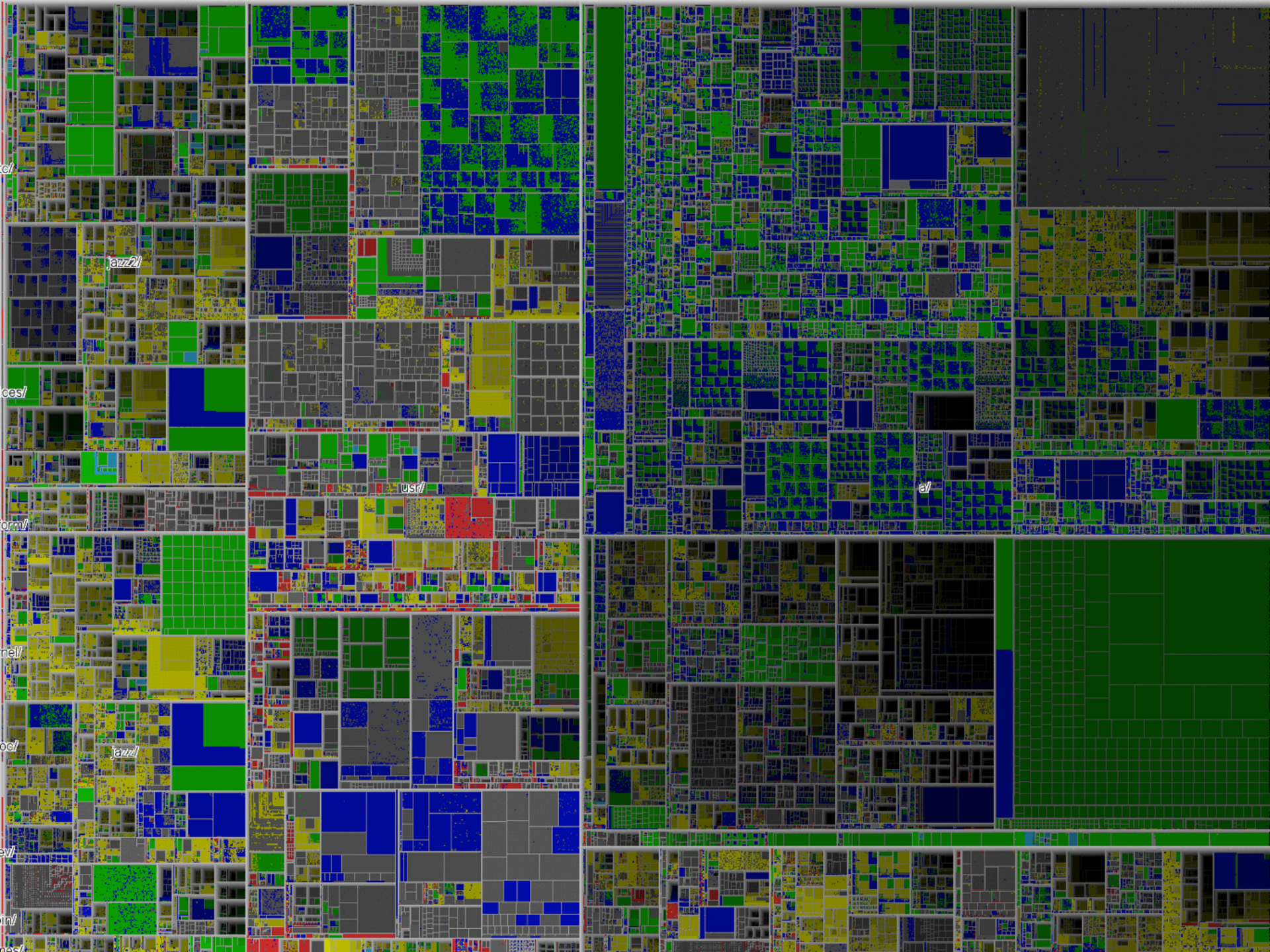

$$\text{Data Density} = \frac{(\# \text{ entries in data})}{(\text{area of graphic})}$$

“Graphical excellence... gives to the viewer the greatest number of ideas in the shortest time with the least ink in the smallest space”

[Tufte 83]

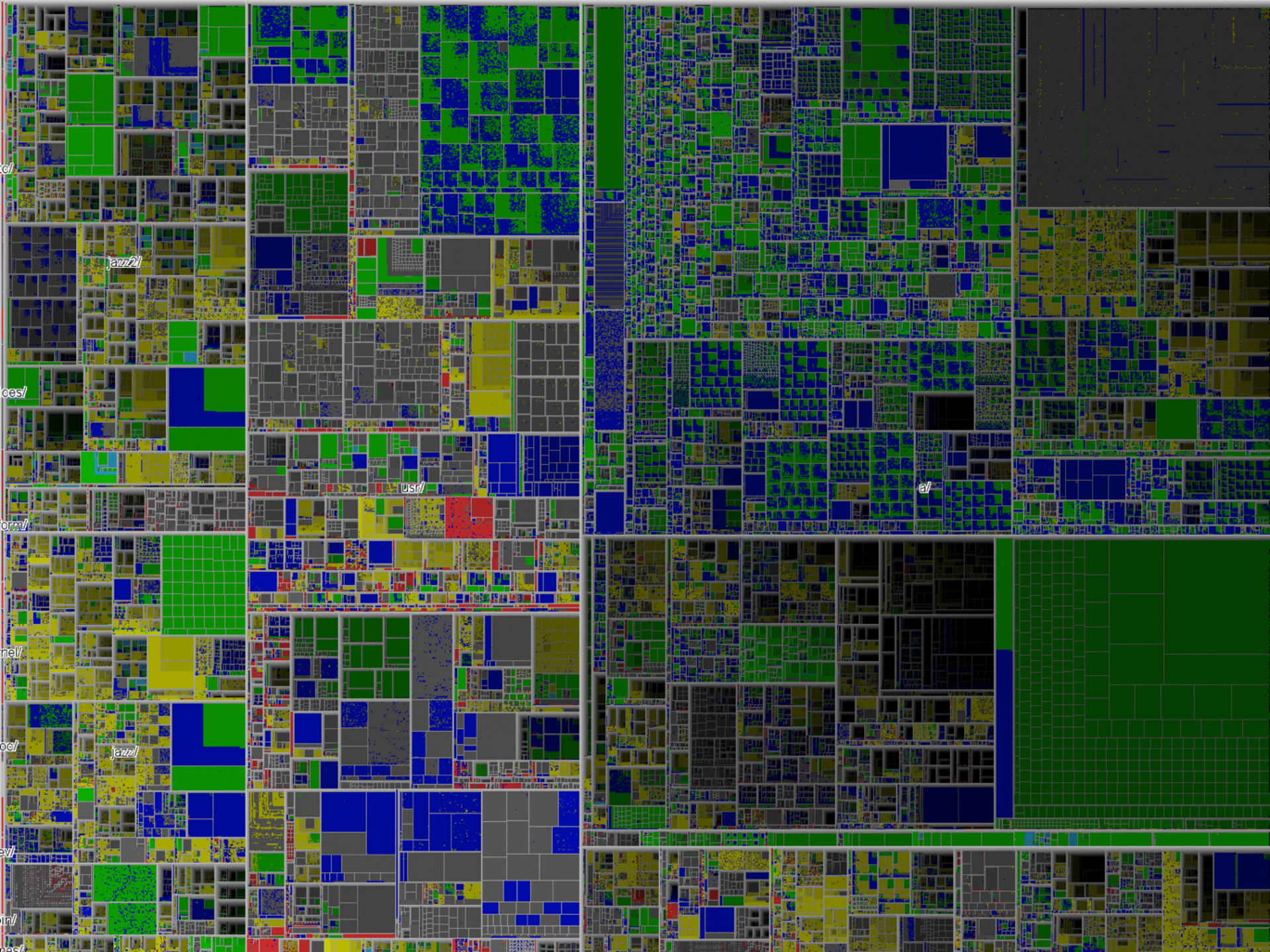

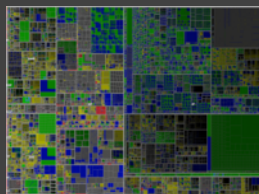

Relative Technology Stock Performance: Jan 2008 - Present

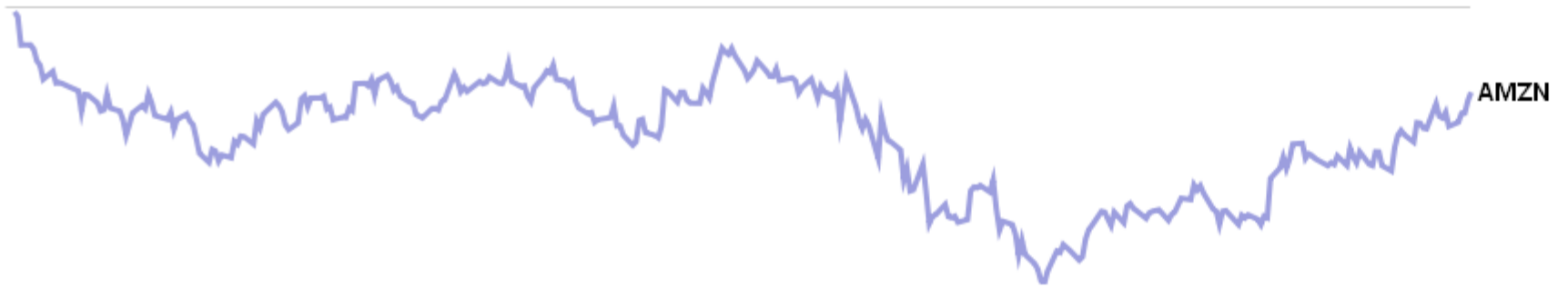

Relative Technology Stock Performance: Jan 2008 - Present

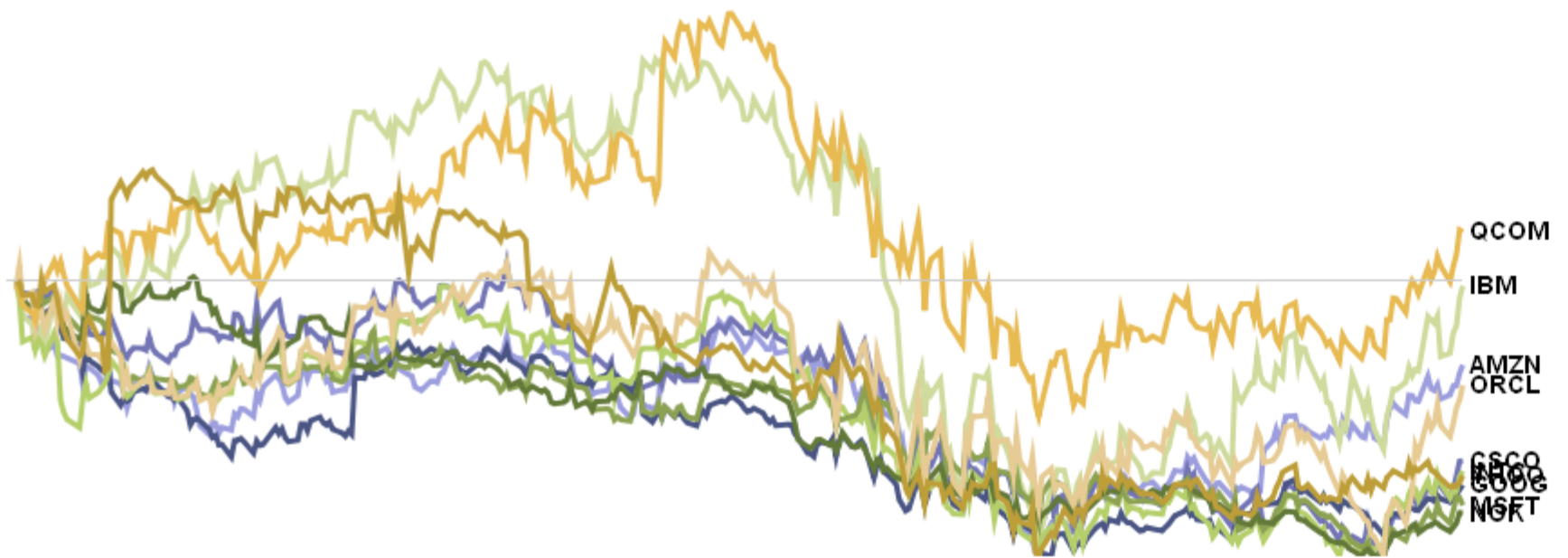

Relative Technology Stock Performance: Jan 2008 - Present

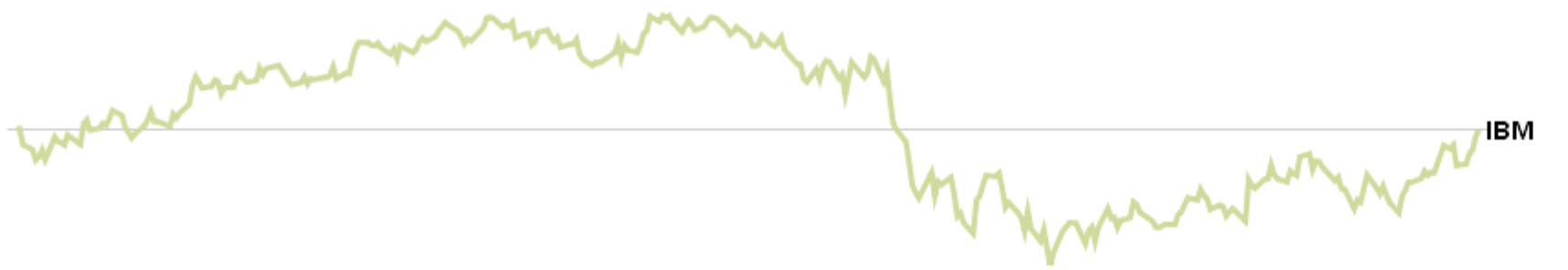
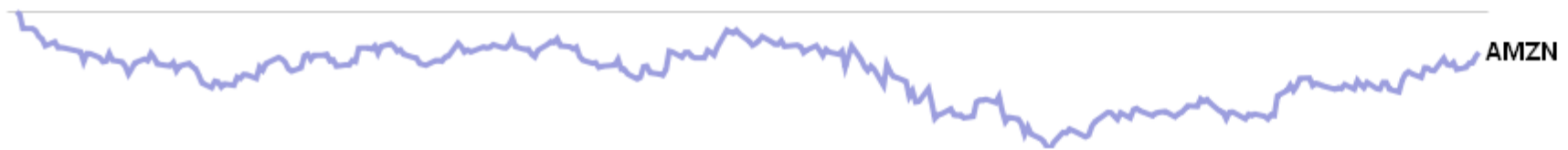

Relative Technology Stock Performance: Jan 2008 - Present

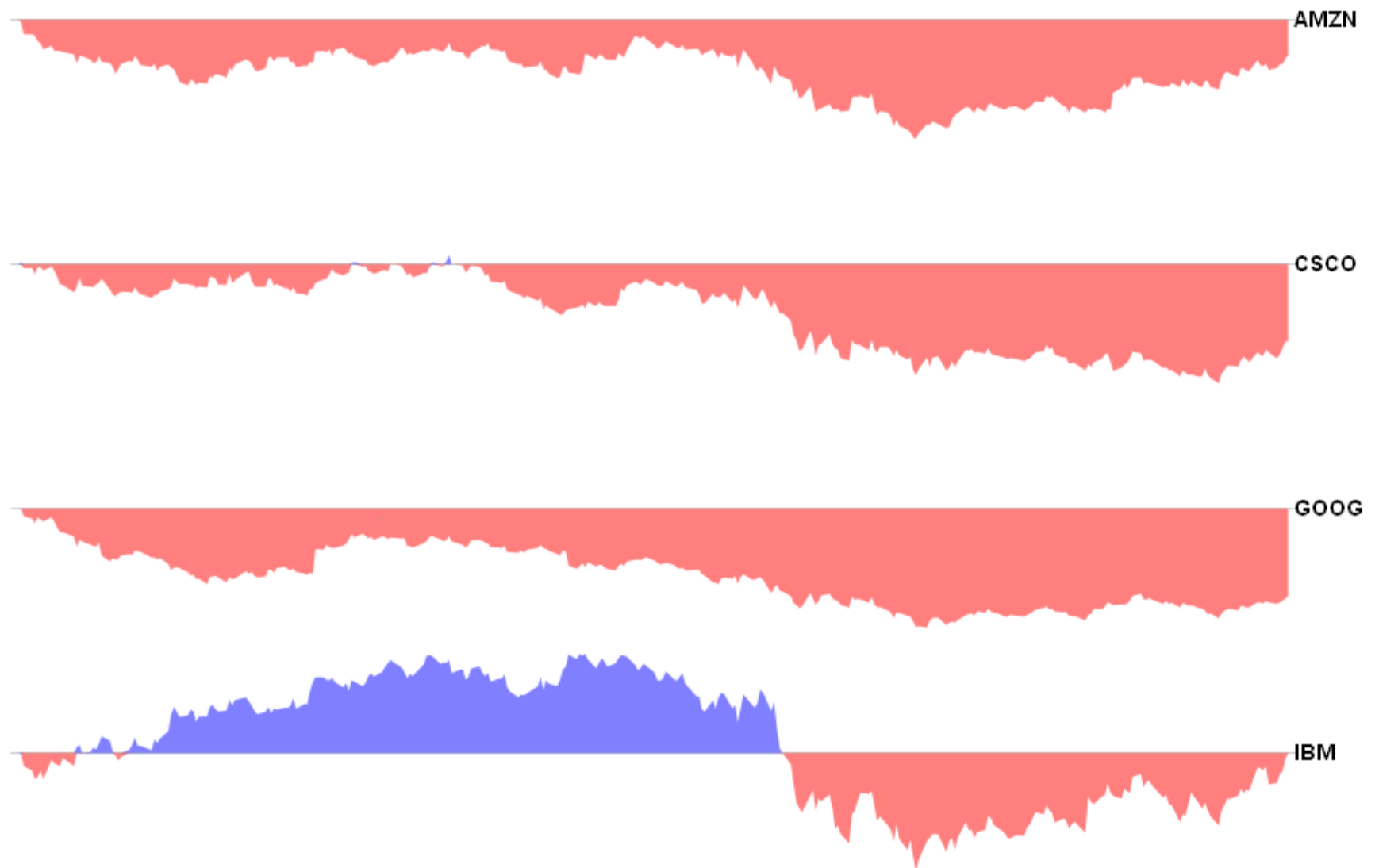

Relative Technology Stock Performance: Jan 2008 - Present

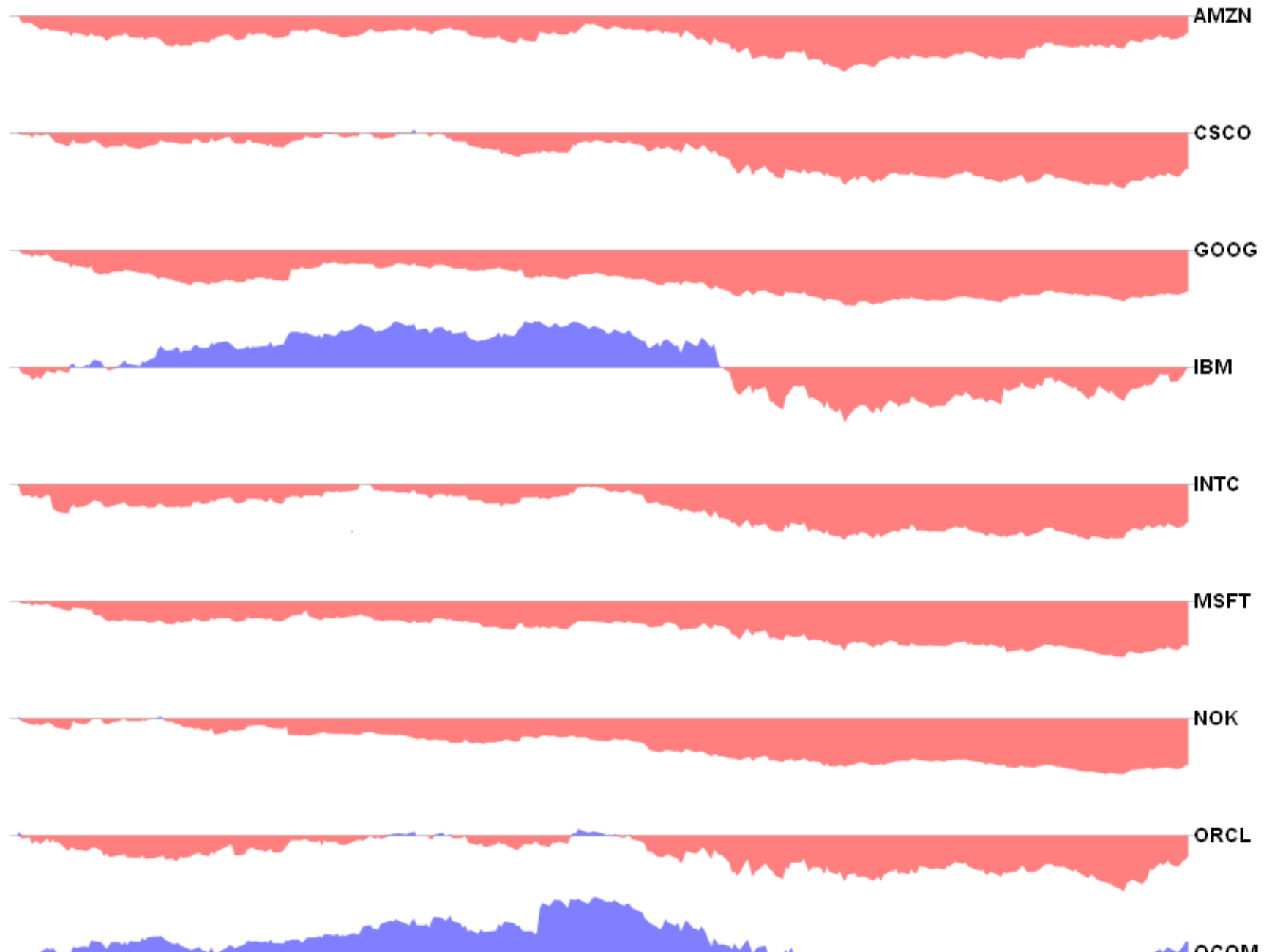

Relative Technology Stock Performance: Jan 2008 - Present

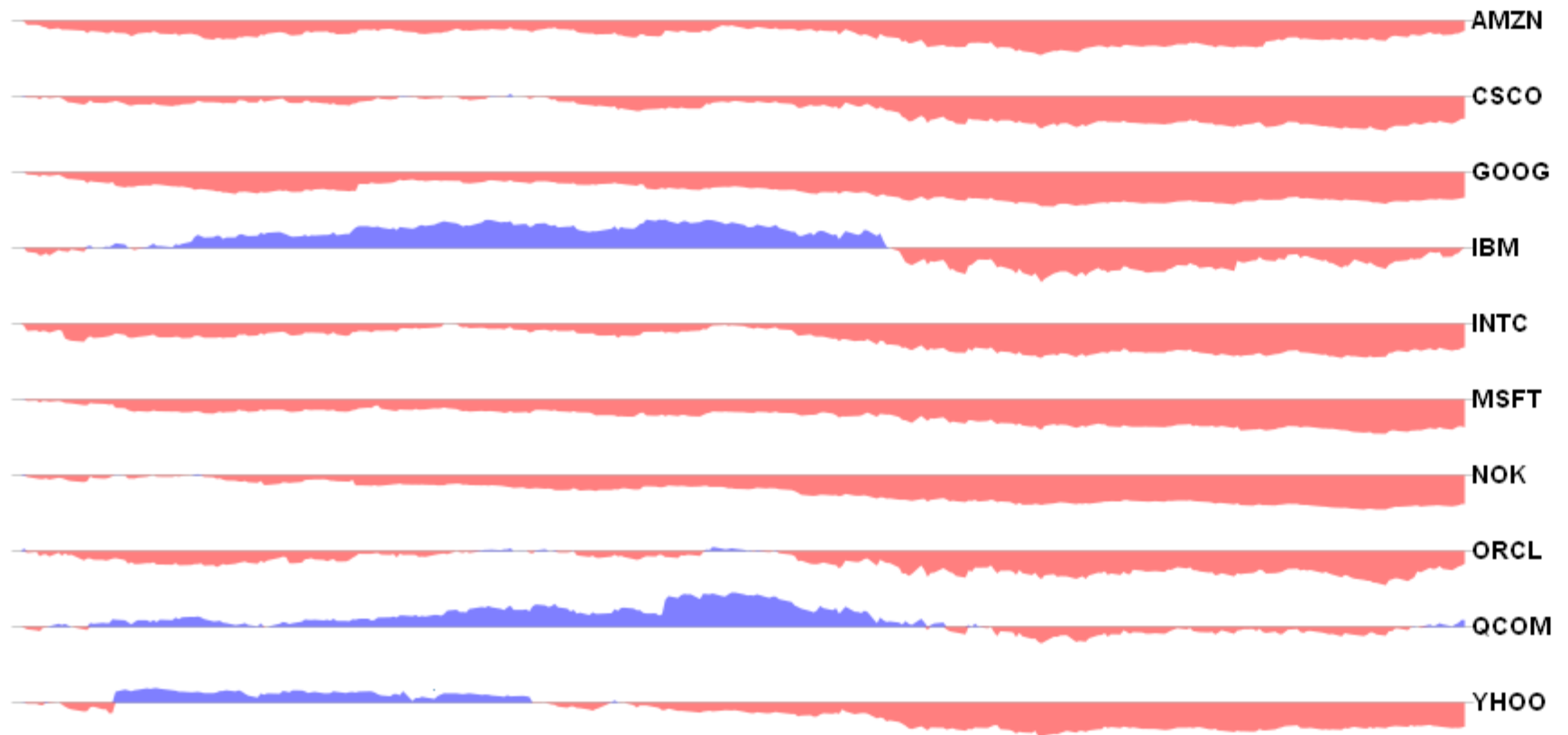

Relative Technology Stock Performance: Jan 2008 - Present

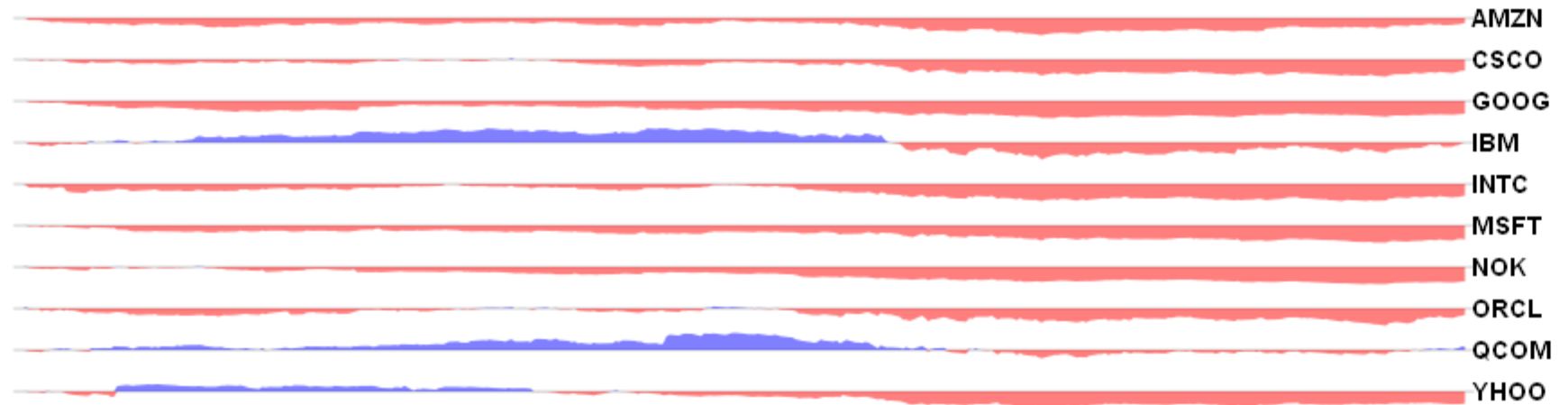

Relative Technology Stock Performance: Jan 2008 - Present

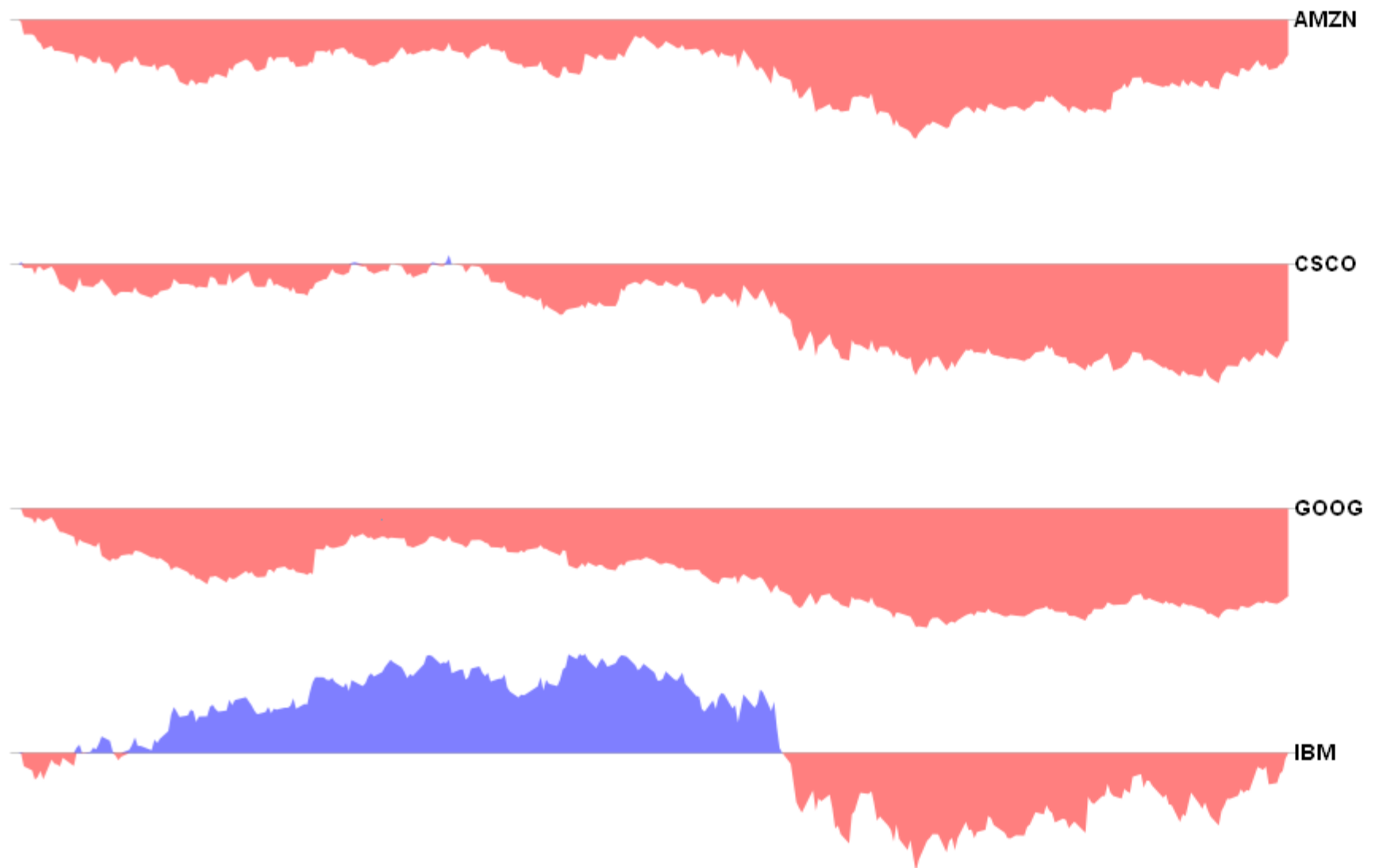

Relative Technology Stock Performance: Jan 2008 - Present

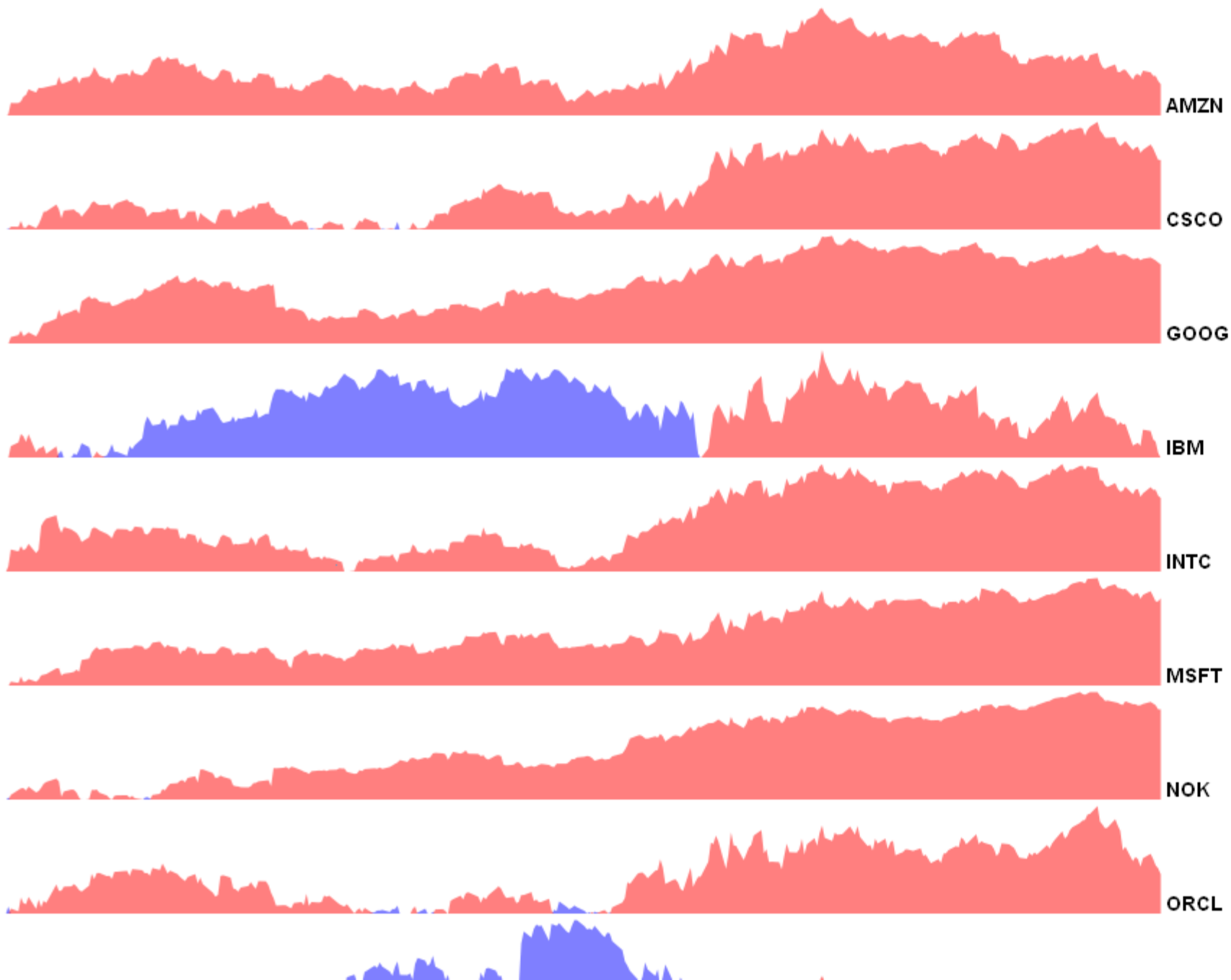

Relative Technology Stock Performance: Jan 2008 - Present

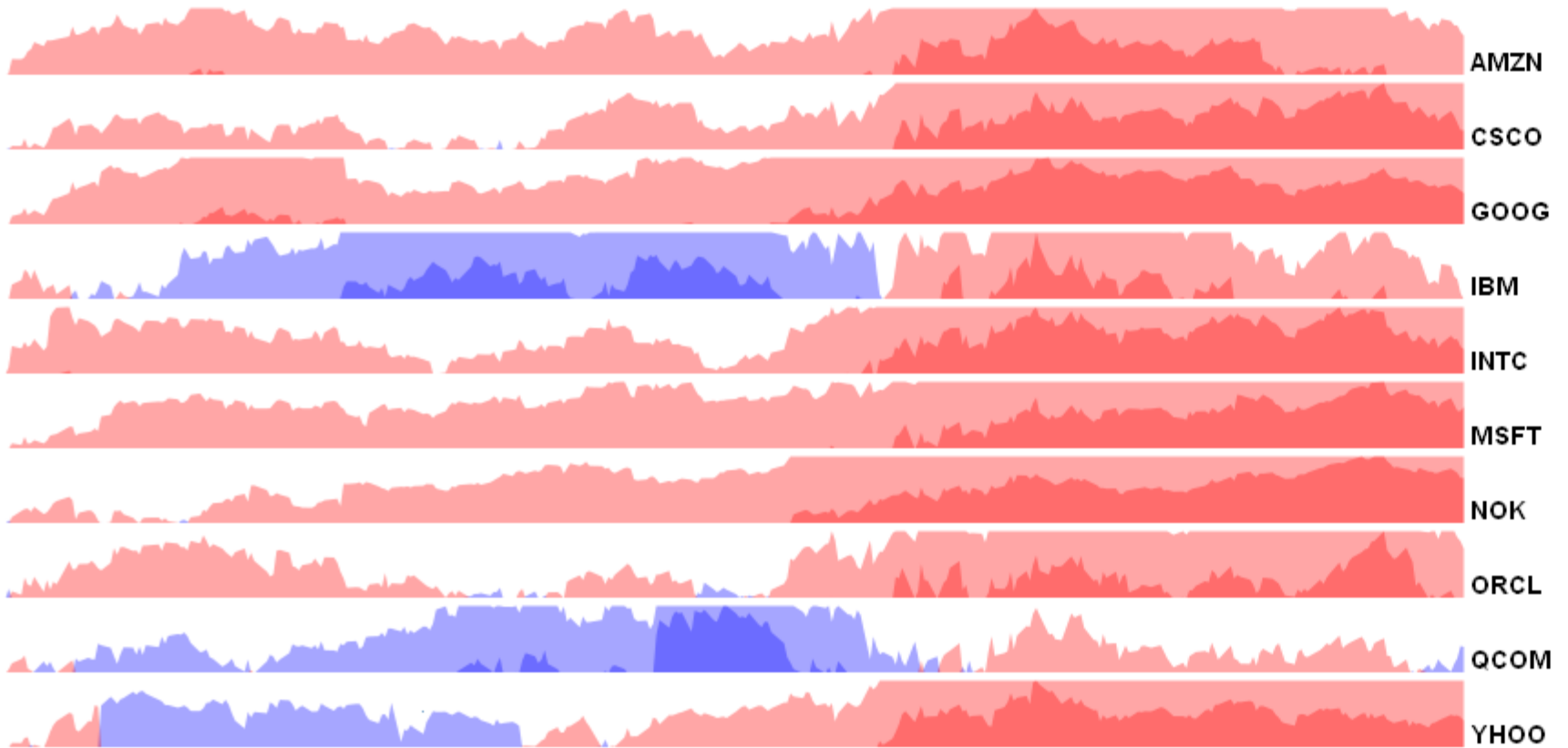

Horizon Graphs

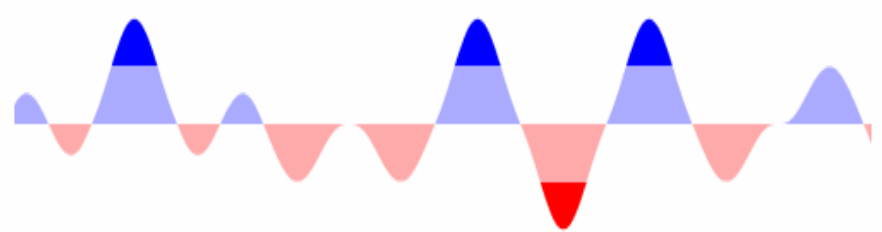

Segment Peaks



Layer Segments



Mirror Negative Values

Relative Technology Stock Performance: Jan 2008 - Present

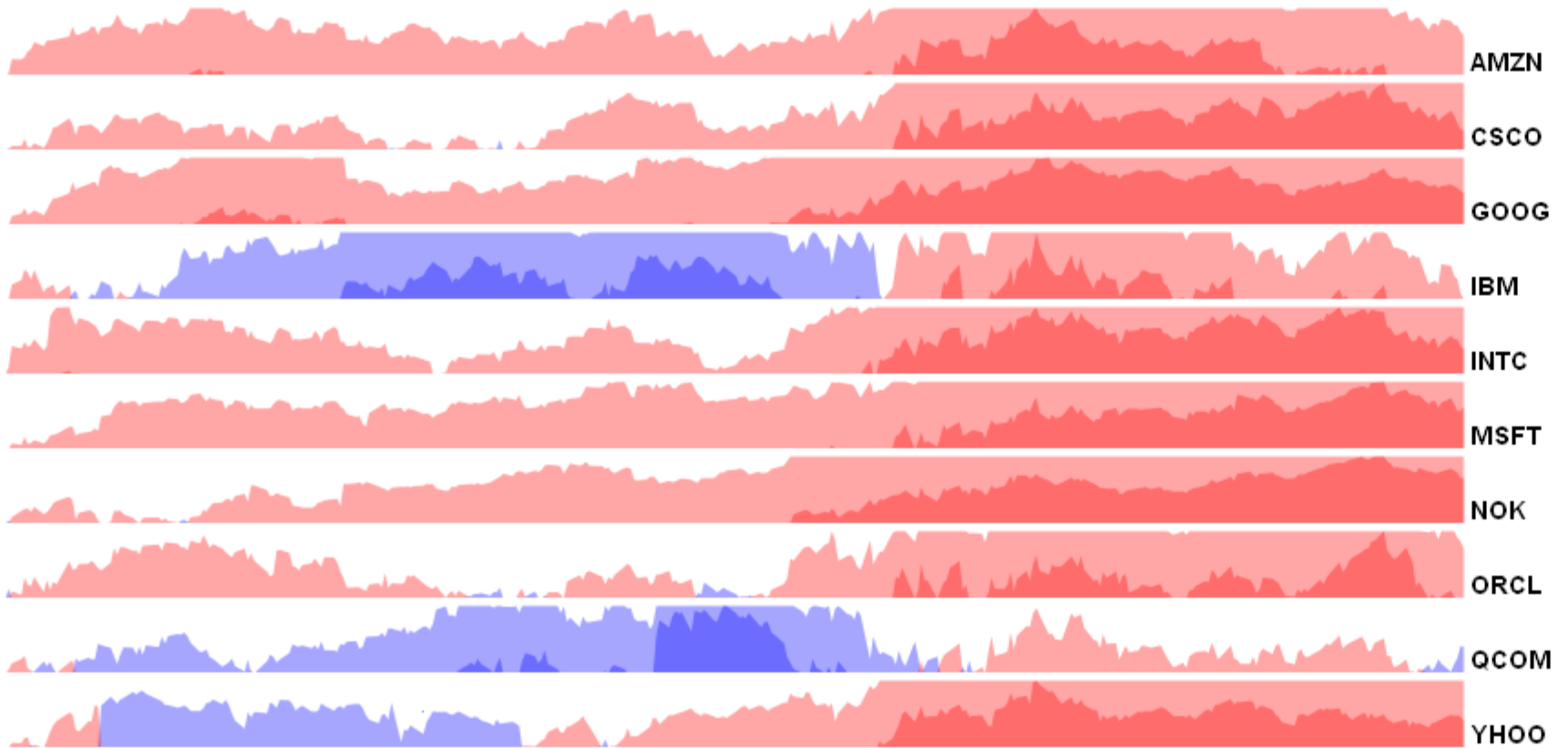

Relative Technology Stock Performance: Jan 2008 - Present

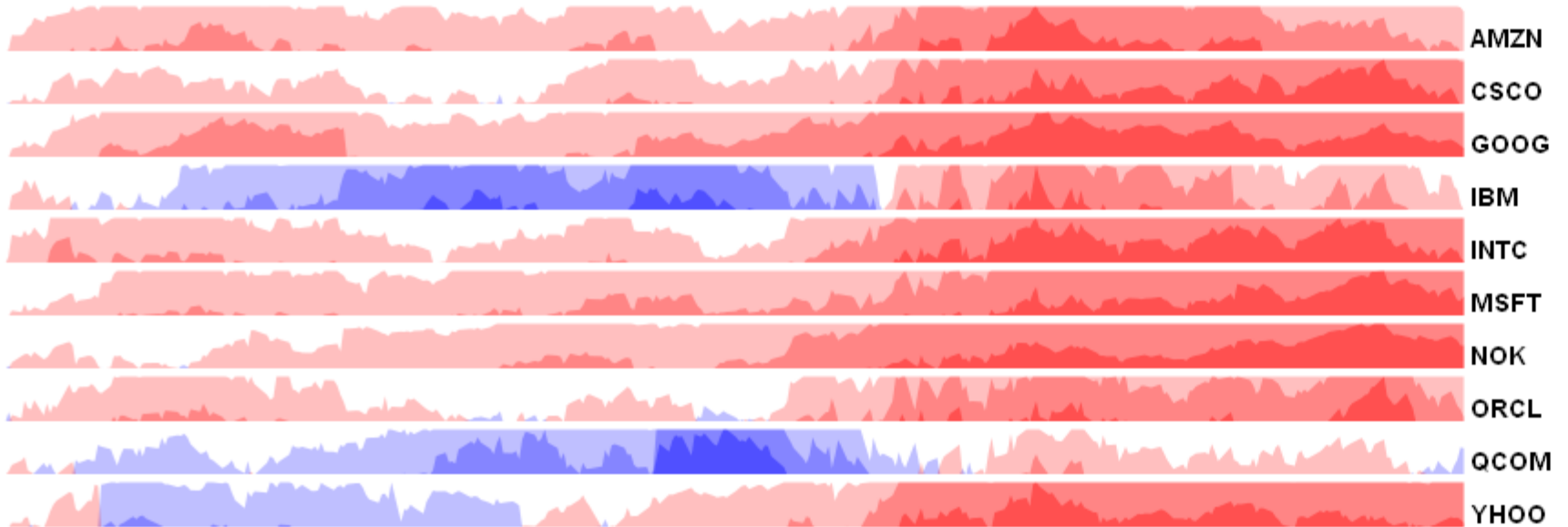

Relative Technology Stock Performance: Jan 2008 - Present

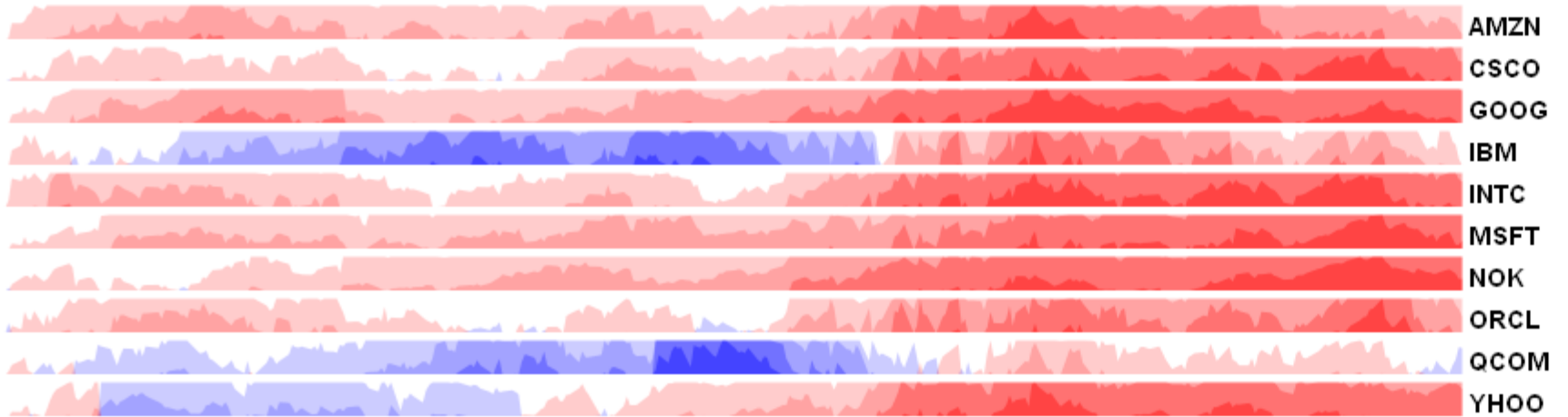

Relative Technology Stock Performance: Jan 2008 - Present

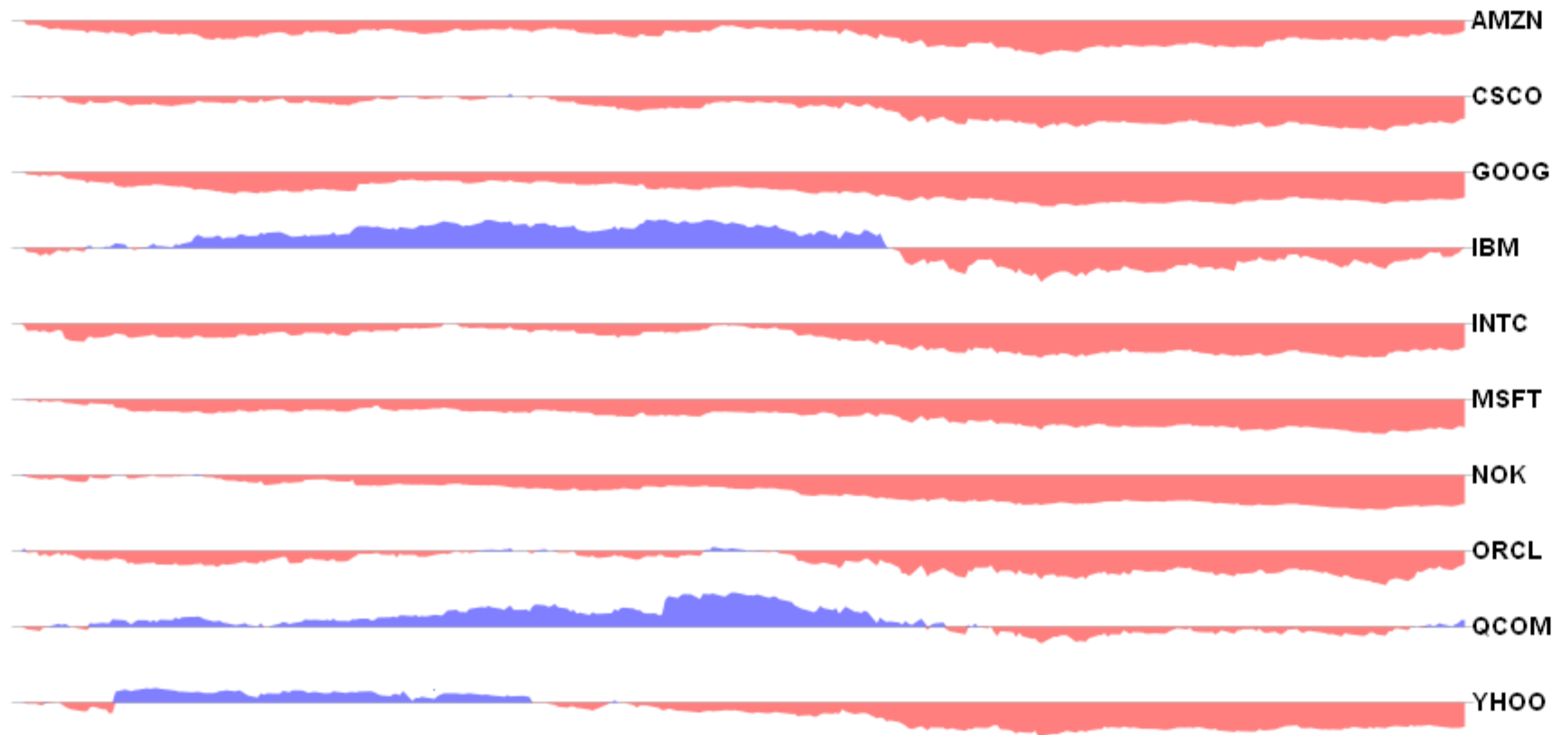

Relative Technology Stock Performance: Jan 2008 - Present

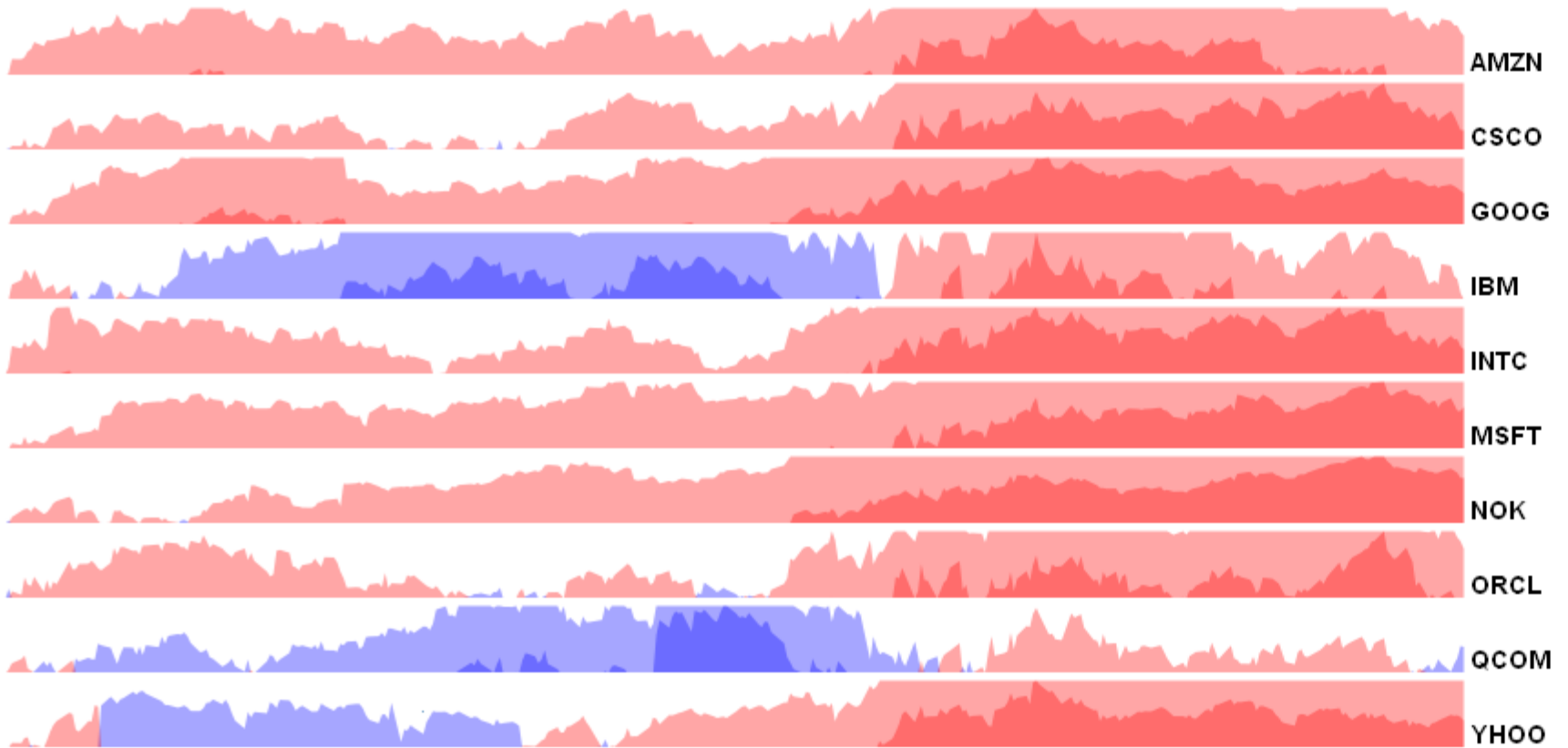

10/03/2005

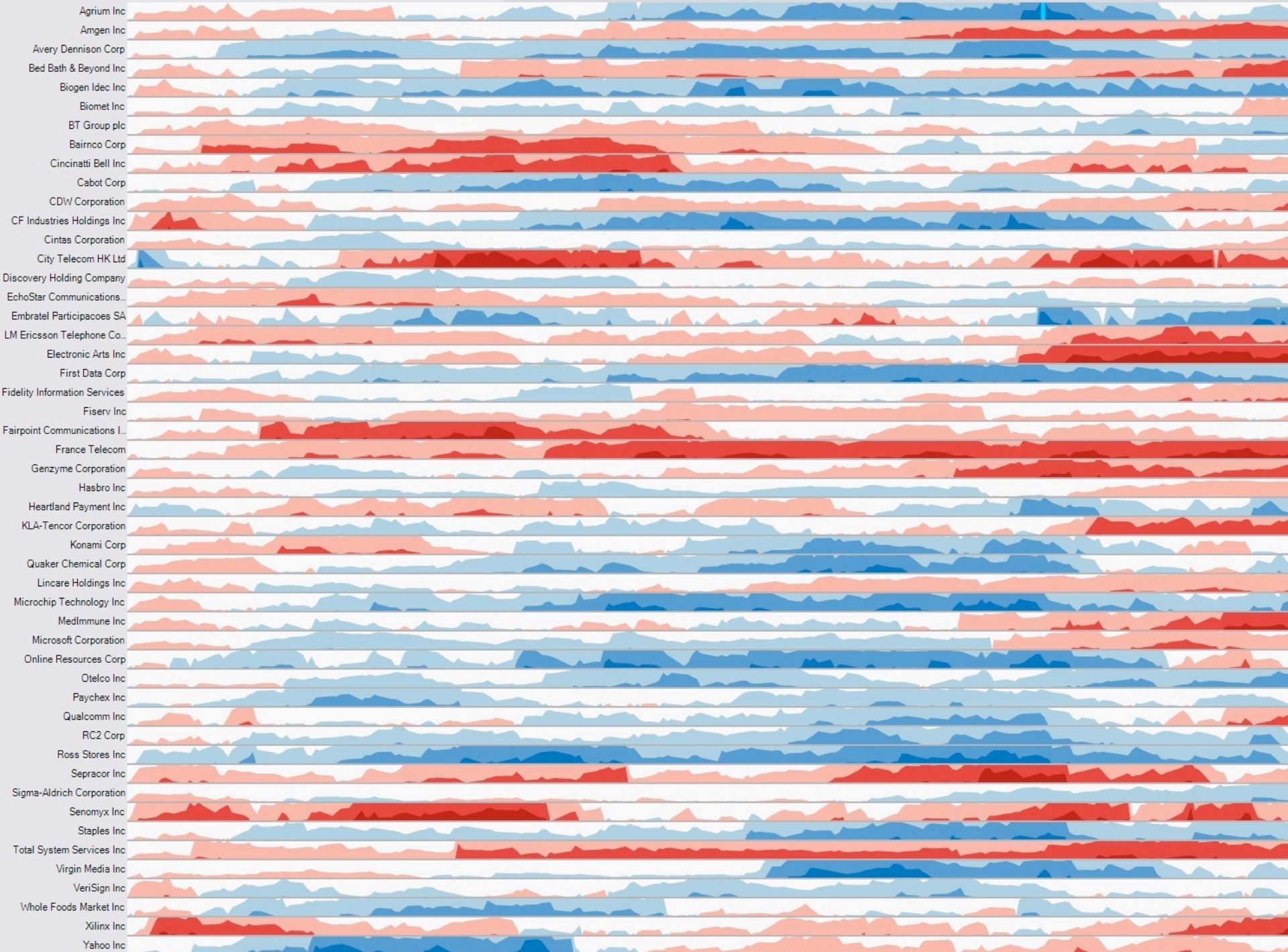

Experiment: Chart Type & Size

Q1: How do mirroring and layering affect estimation time and accuracy compared to line charts?

Q2: How does chart size affect estimation time and accuracy?

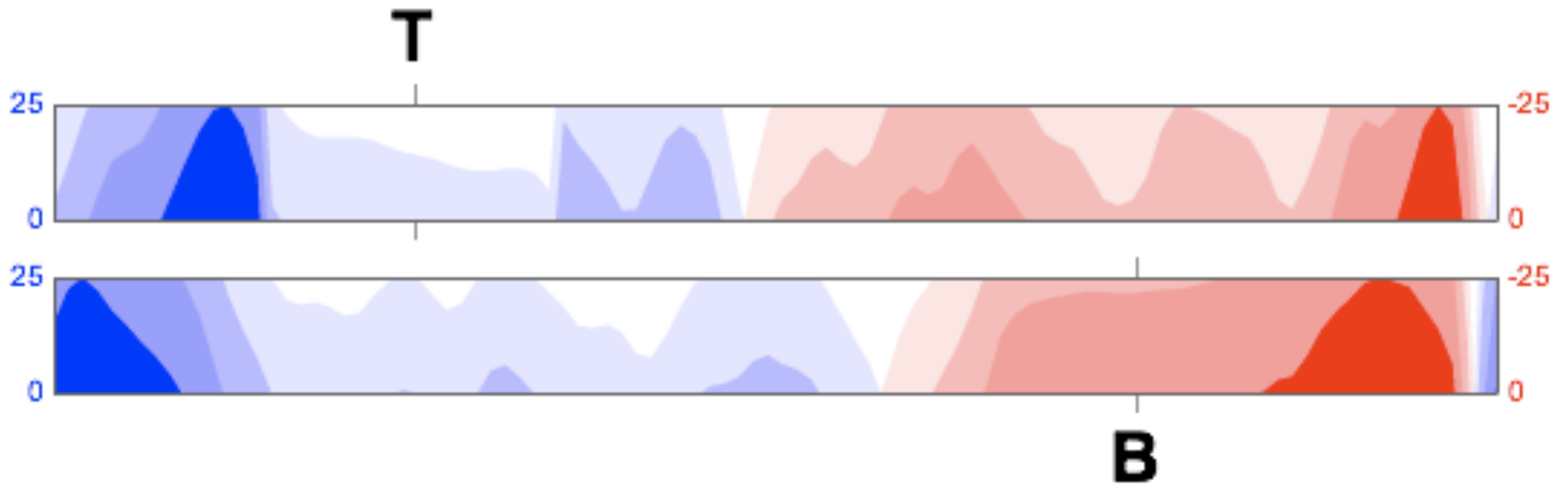

Estimate the difference between T and B (0-200) to within 5 values.

Experiment Design

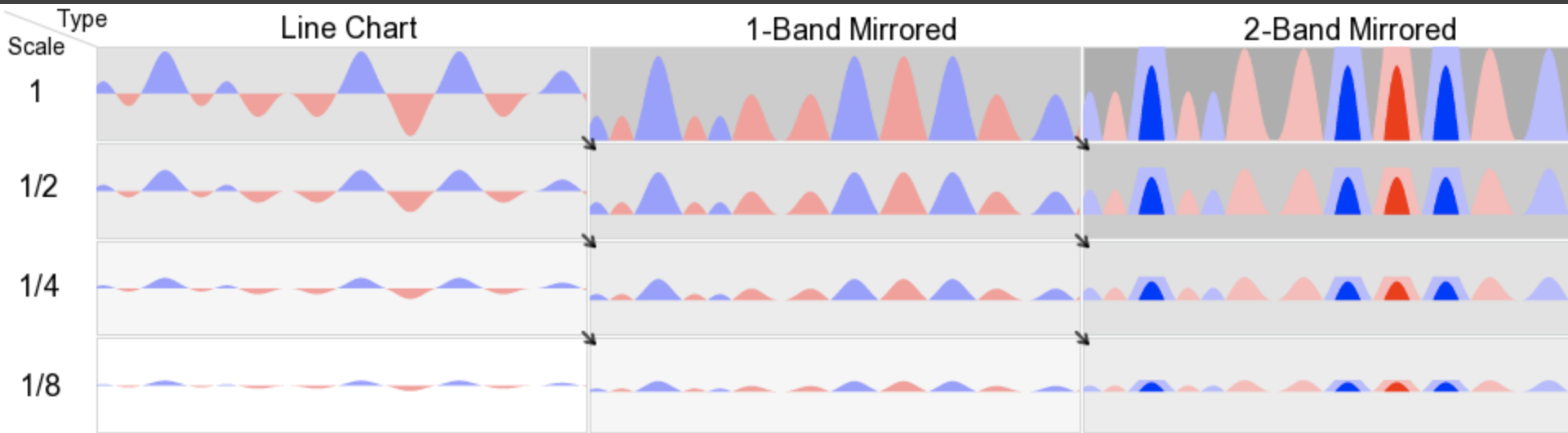

- 3 (chart type) x 4 (size) within-subjects design
- N = 30 (17 male, 13 female), undergrads
 - 14.1 inch LCD display, 1024 x 768 resolution
 - At scale = 1, chart is 13.9 x 1.35 cm (48 px)

Experiment Design

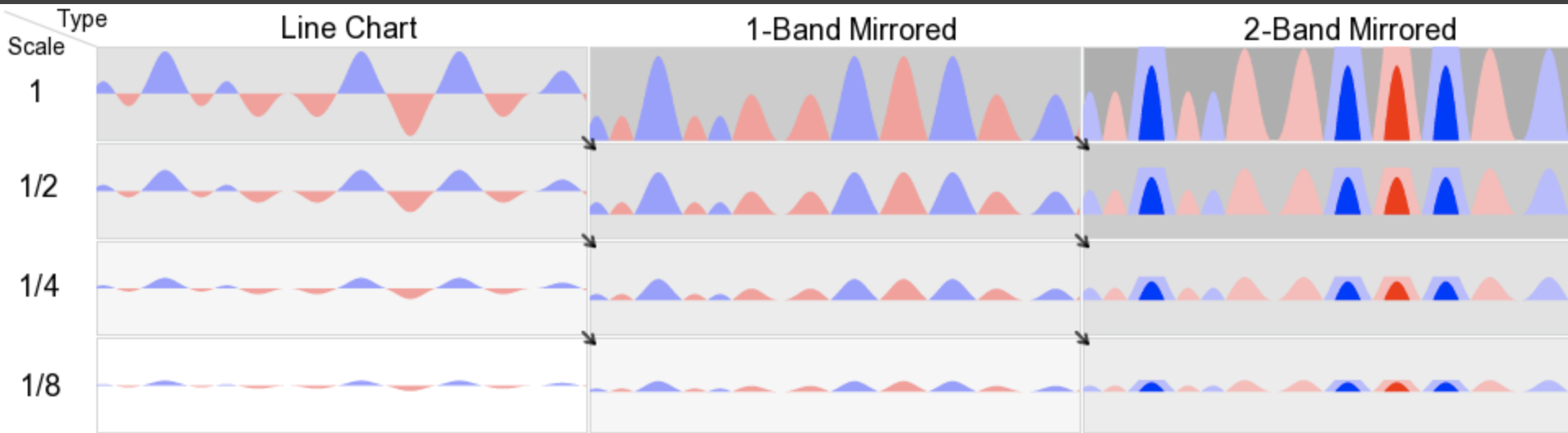

3 (type) x 4 (size) within-subjects design

N = 30 (17 male, 13 female), undergrads

2 (type) x 3 (size: 1/8, 1/12, 1/24) follow-up

N = 8 (6 male, 2 female), engineering grads

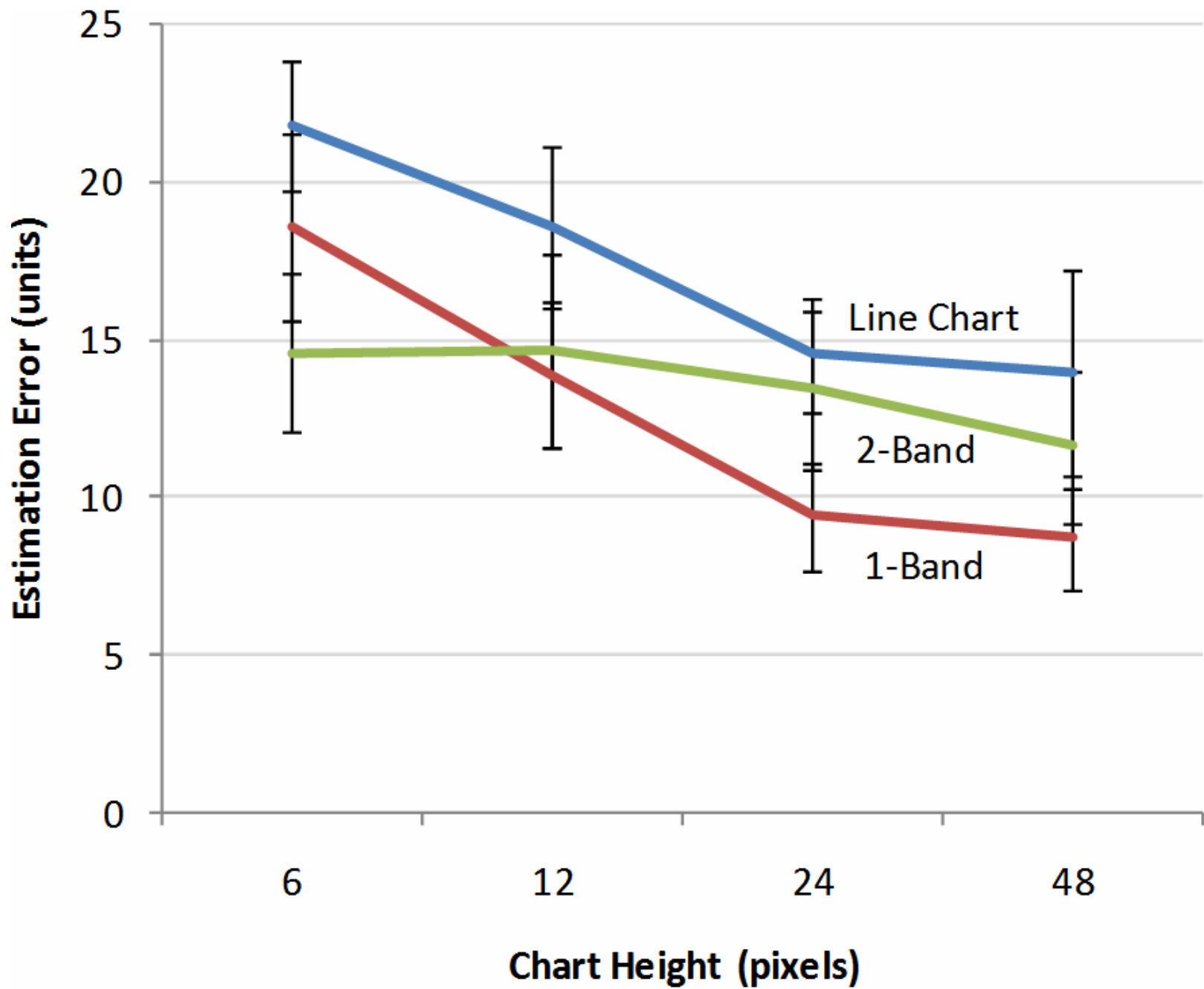

Virtual Resolution (VR)

The un-mirrored, un-layered height of a chart



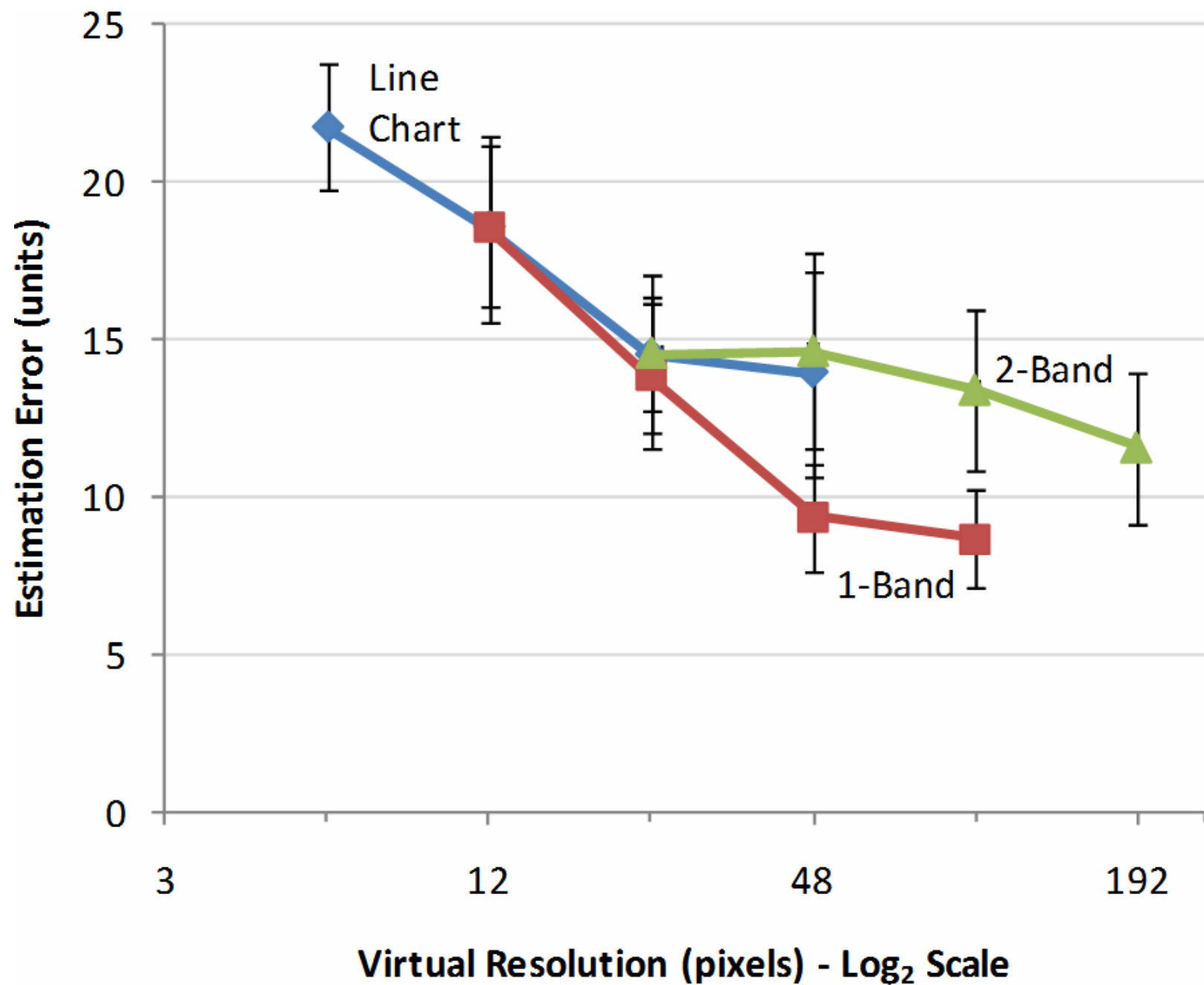

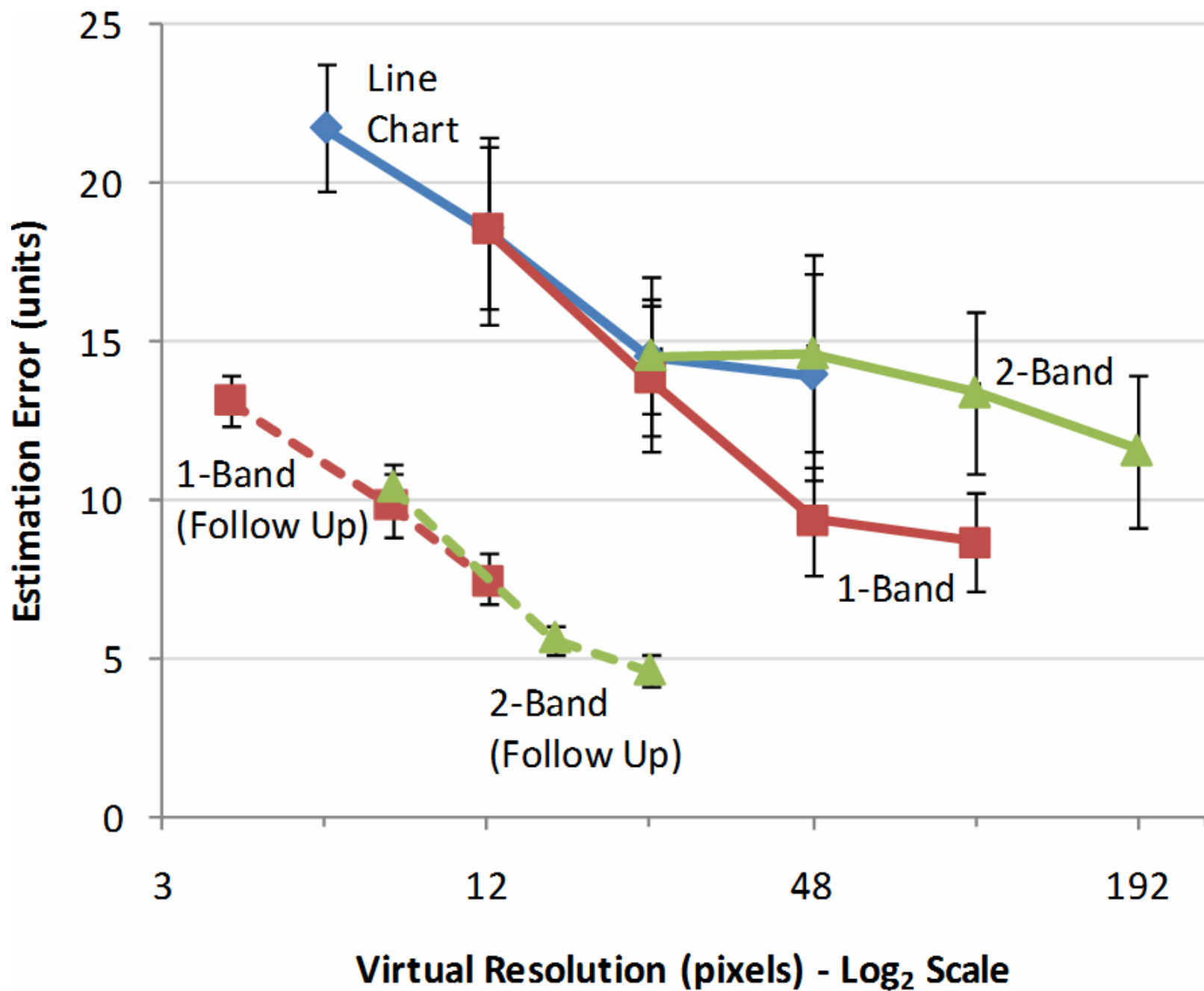

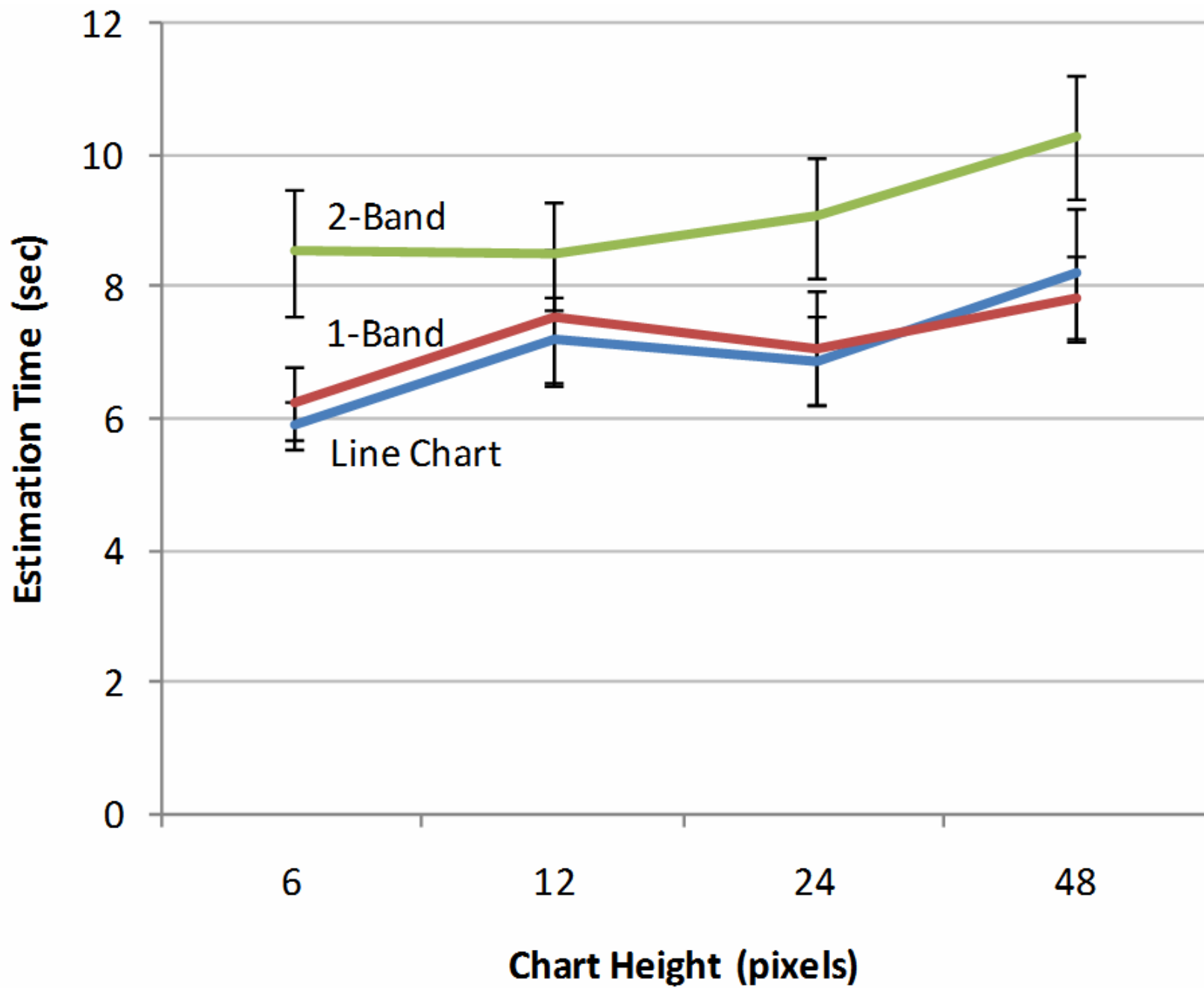

Experiment Results

Q1: 2-band horizon graph (but not mirrored graph) has higher baseline estimation time and error.

Q2: Estimation error increases as the *virtual resolution* decreases.

Estimation time decreases as the *physical height* decreases.

Design Guidelines

Mirroring does not hamper perception

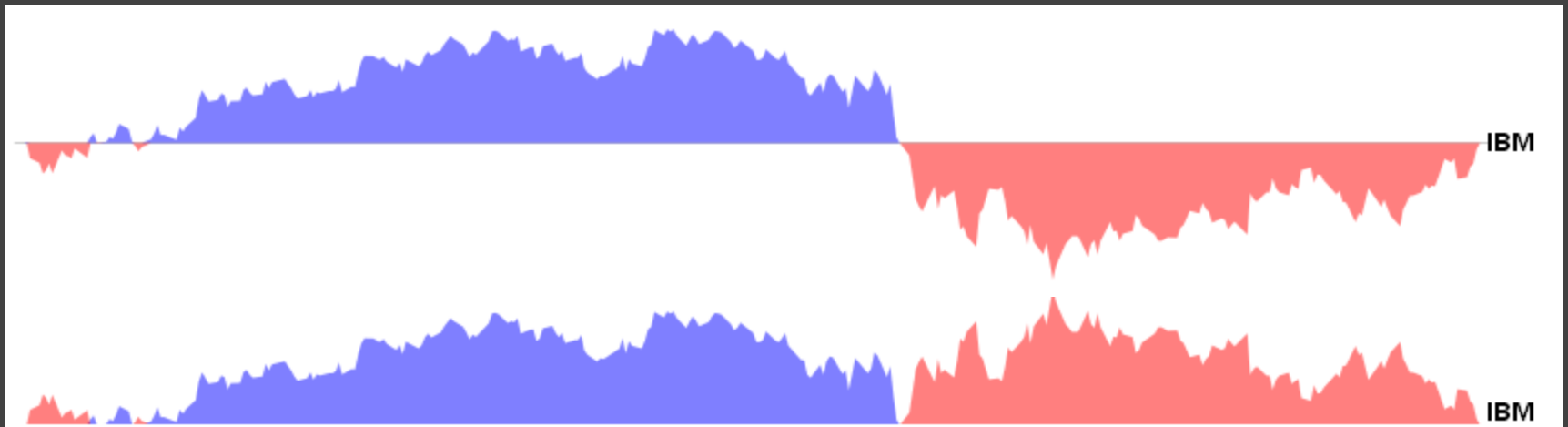

Design Guidelines

Mirroring does not hamper perception

Layered bands beneficial for smaller charts

2-band mirror charts more accurate for heights under 6.8mm (24 pixels @ 1024x768)

Predict benefits for 3 bands under 1.7mm (6 px)

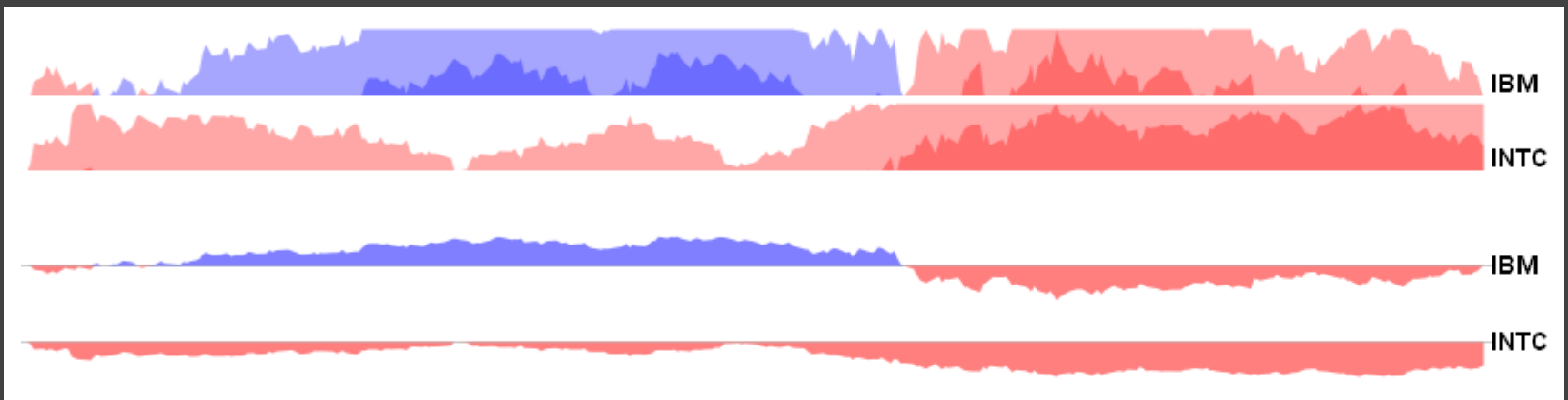

Design Guidelines

Mirroring does not hamper perception

Layered bands beneficial for smaller charts

Optimal chart sizing

Sweet spots in time/error curves

6.8mm (24 px) for line chart & mirrored chart

3.4mm (12 px) for 2-band horizon graph

FOLLOW-UP QUESTION:

What other **tasks** and
performance measures
should one test?

Administrivia

Final Project

Poster Presentations

Session is **Mon Jun 8 5-8pm** in CSE Atrium

Bring **Poster + Laptop/Device** for demos

Arrive early to setup!

Post Webpage on GitHub Pages

List team members, title, abstract, link to paper

Include summary image for project!

Final Project Reports

Due **Thu Jun 11**, by **8am**, posted to GitHub

4-6 pages in ACM or IEEE TVCG format

Perceptual Organization of Node-Link Diagrams

Perceptual Organization of Graphs

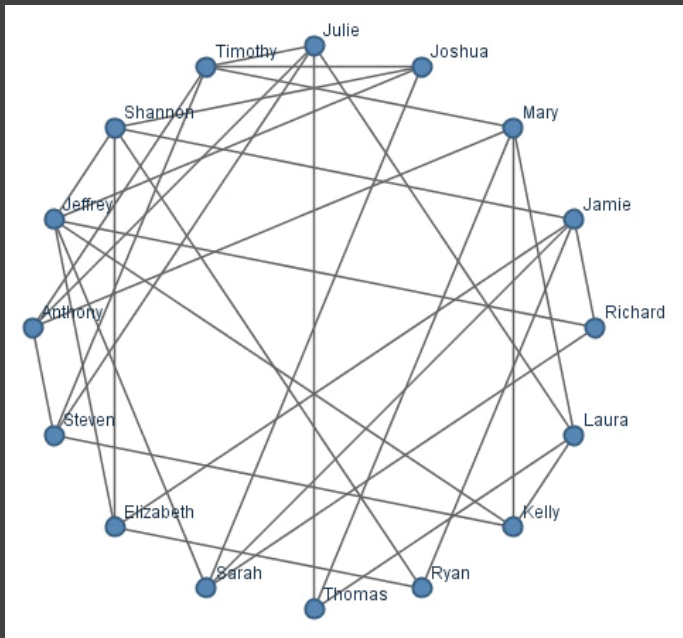

Circular

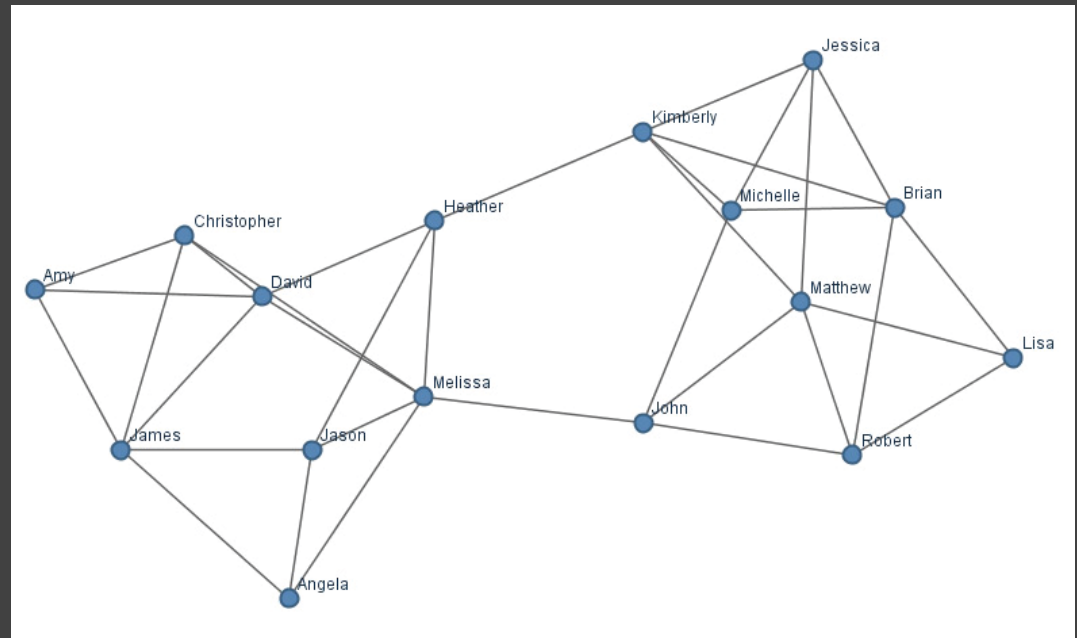

Force-Directed

Experiment Design

Factors

Circular or Force-Directed Seed Layout

of Between-Cluster Edges ("masking")

All graphs had two primary clusters

Measures

of Edge Crossings

Average Edge Length

Average Node Distance

within or between clusters

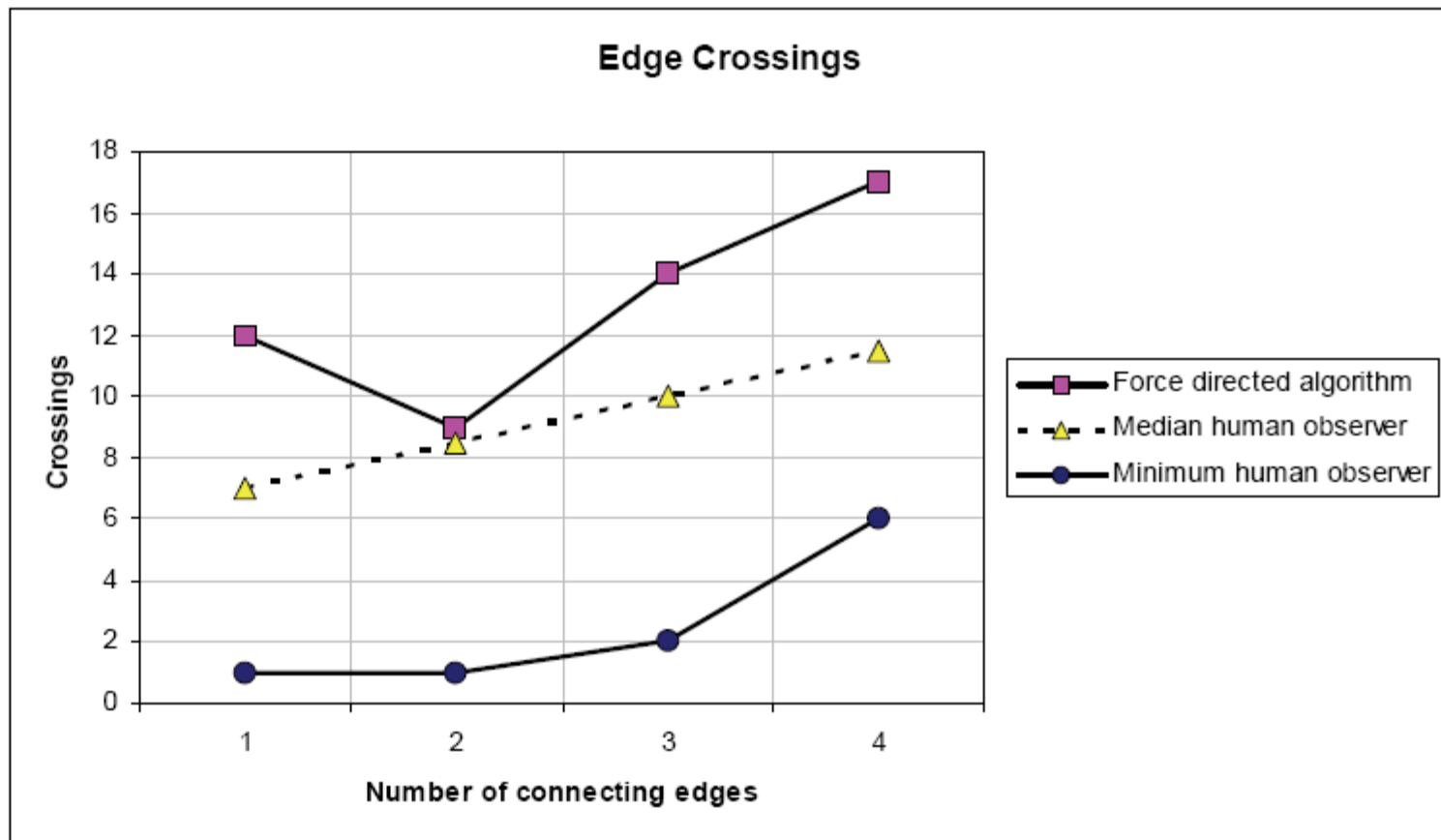

Figure 4. Edge Crossings. Human observers produced graph layouts with fewer edge crossings than the force-directed graph algorithm.

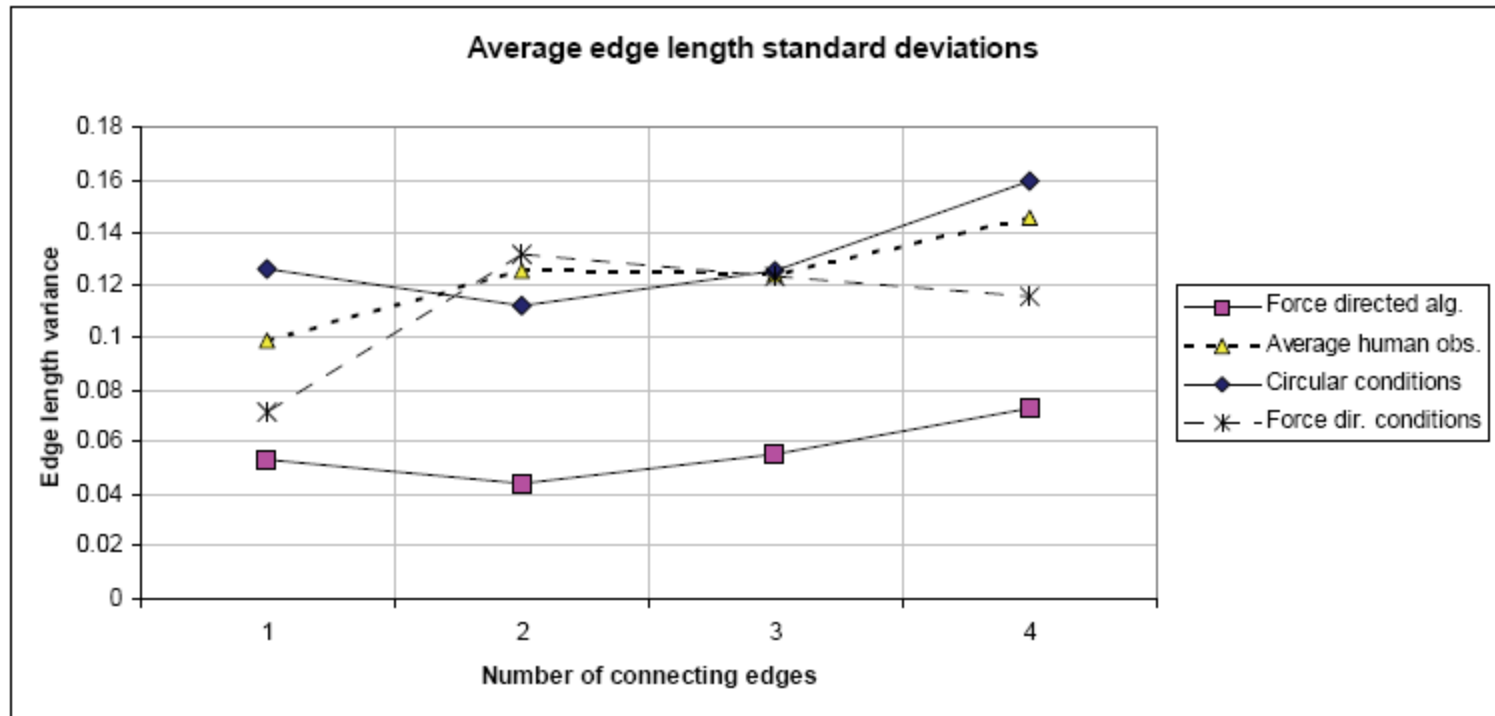

Figure 5. Edge Length Distribution. Human observers did not focus on maintaining equal edge length as much as the force directed algorithm.

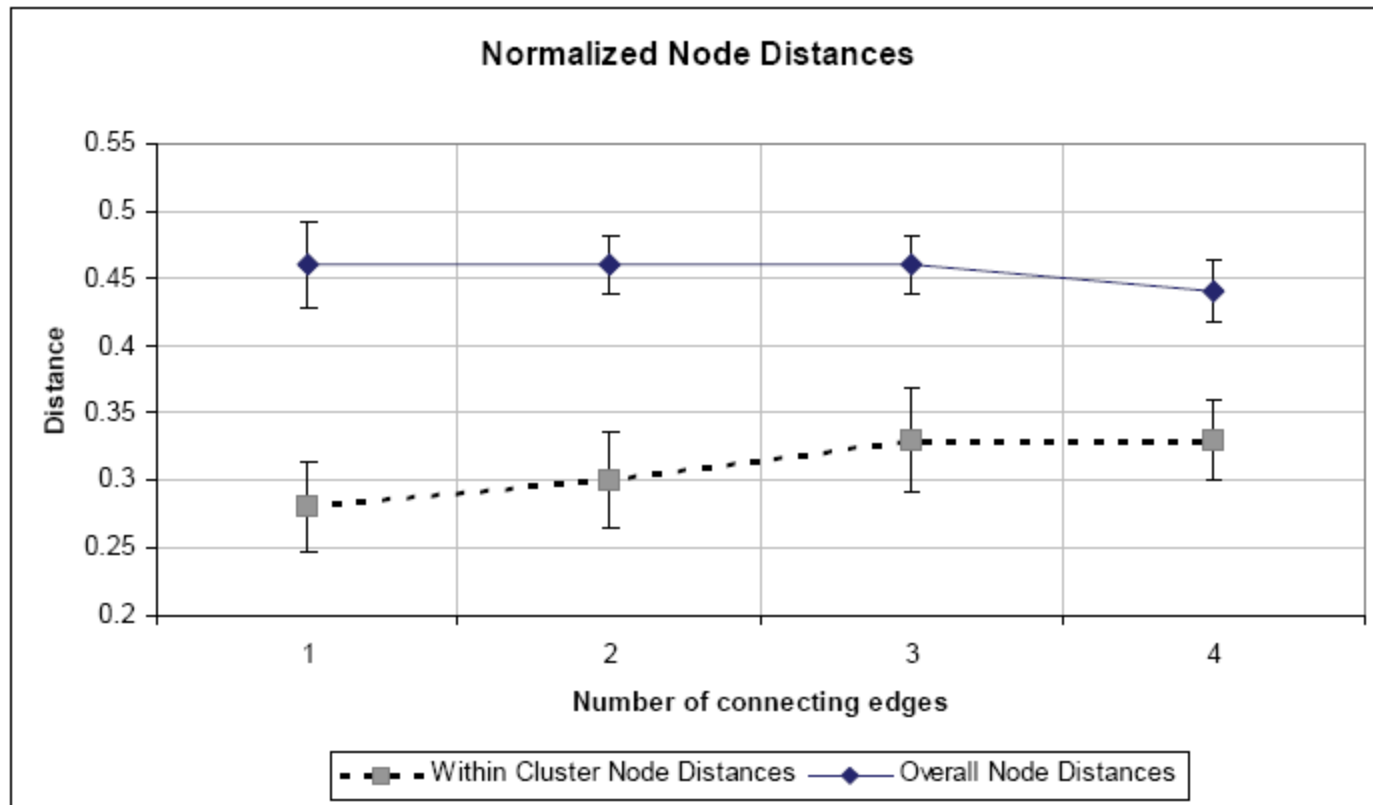

Figure 7. Cluster Extraction. For all levels of masking, the distance between nodes within a cluster is significantly smaller than the overall inter-node distance, demonstrating perceptual grouping. Error bars show 95% confidence intervals

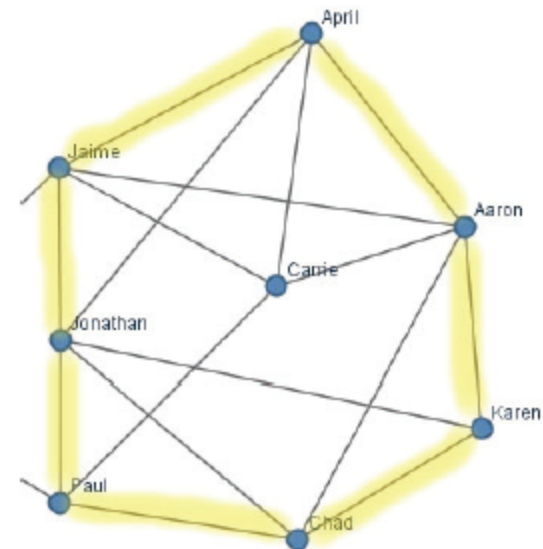
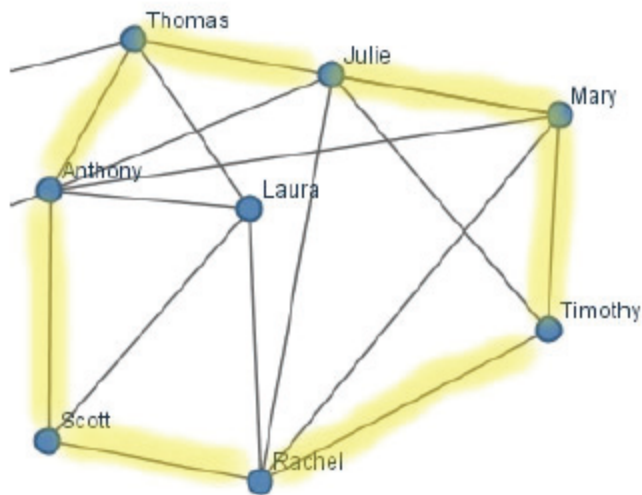
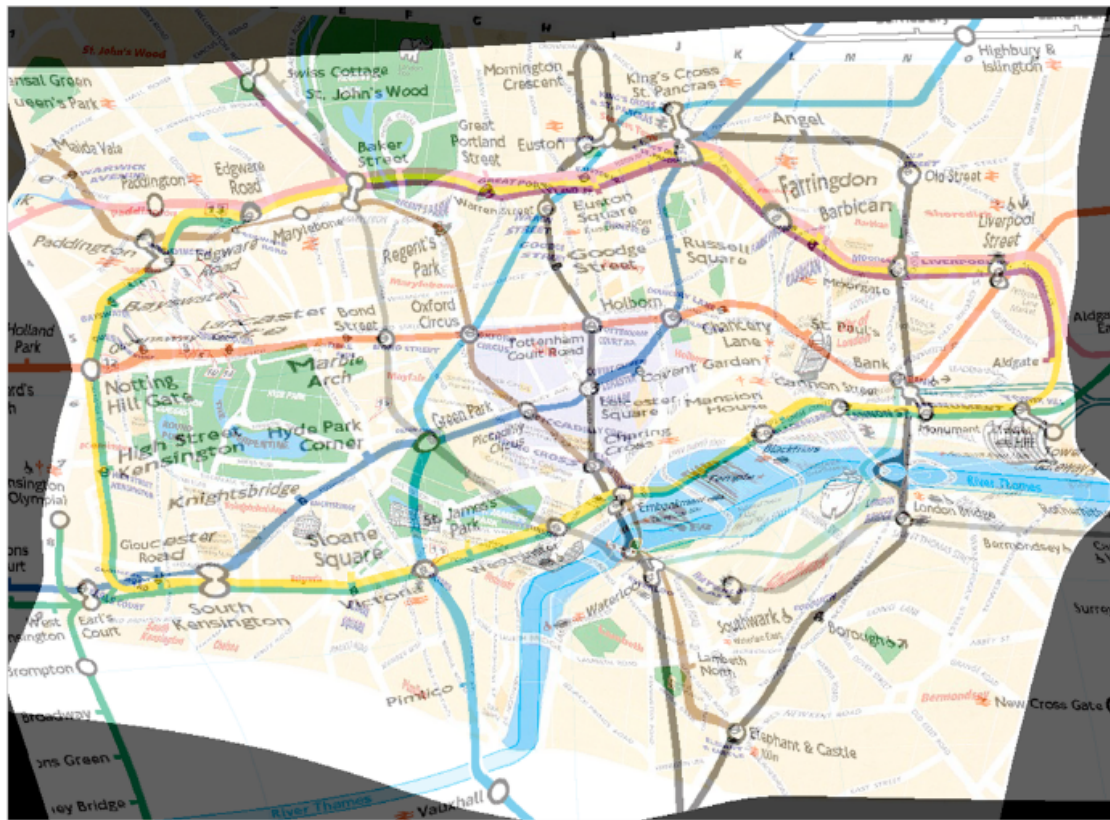

Figure 9. Cluster Hulls. Two examples of user-generated layouts where cluster edges formed a hull enclosing the cluster, organizing it into a single perceptual group.

Role of Environment [Reilly '07]





The slider was used to control the bidirectional morph. Shape blending (distortion) and alpha blending occurred simultaneously, in proportion to the distance of the slider from each endpoint.



The Tube map was at the left endpoint of the morph.



The right endpoint showed the tourist map.

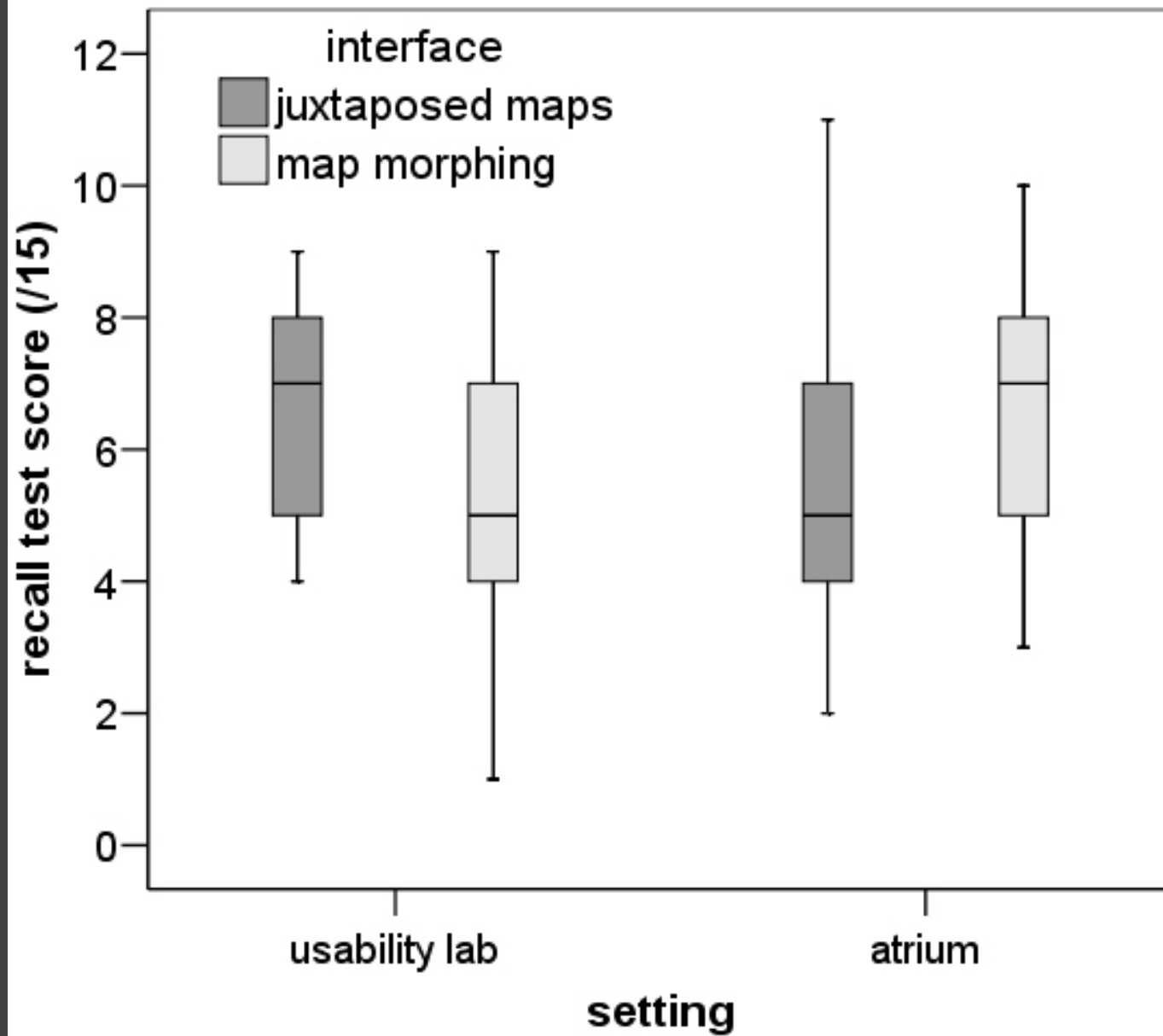

Summary

Design and analyze visualization techniques in context of real-world use.

Time/error analyses can be insightful, but they don't provide a complete picture.

Performance measures may be more suited to serious analysis than casual use?

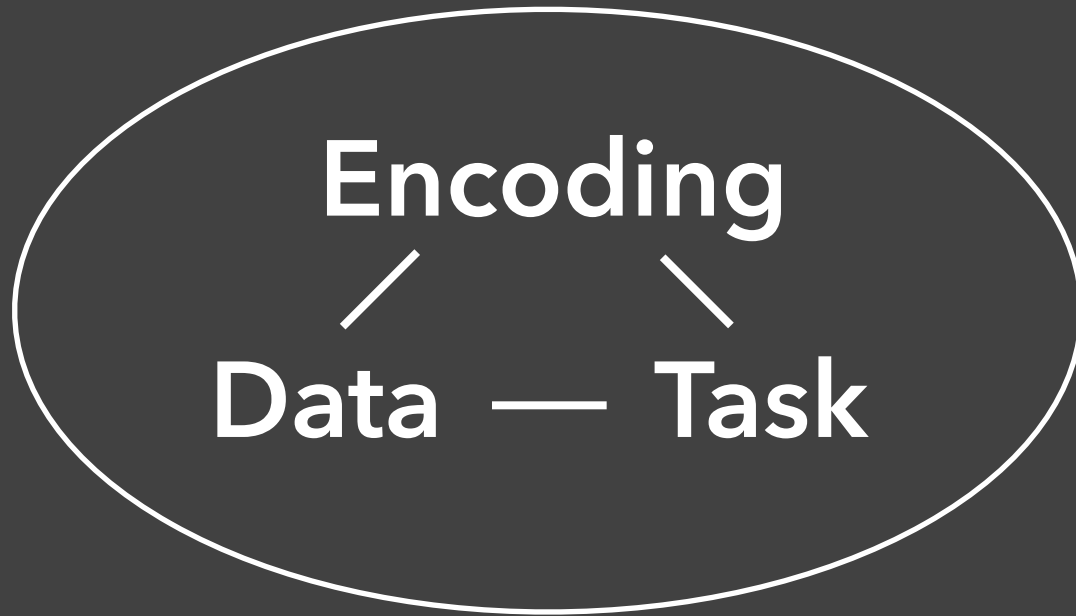

Users & Domain

Course Summary

Data and Image Models

LES VARIABLES DE L'IMAGE										
						12	14			
						POINTS	LIGNES	ZONES		
XY 2 DIMENSIONS DU PLAN										
Z TAILLE										
VALEUR										
LES VARIABLES DE SÉPARATION DES IMAGES										
						13				
GRAIN										
COULEUR										
ORIENTATION										

Visualization (Re-)Design

SlicerDicers' Sales Compared to Other Products

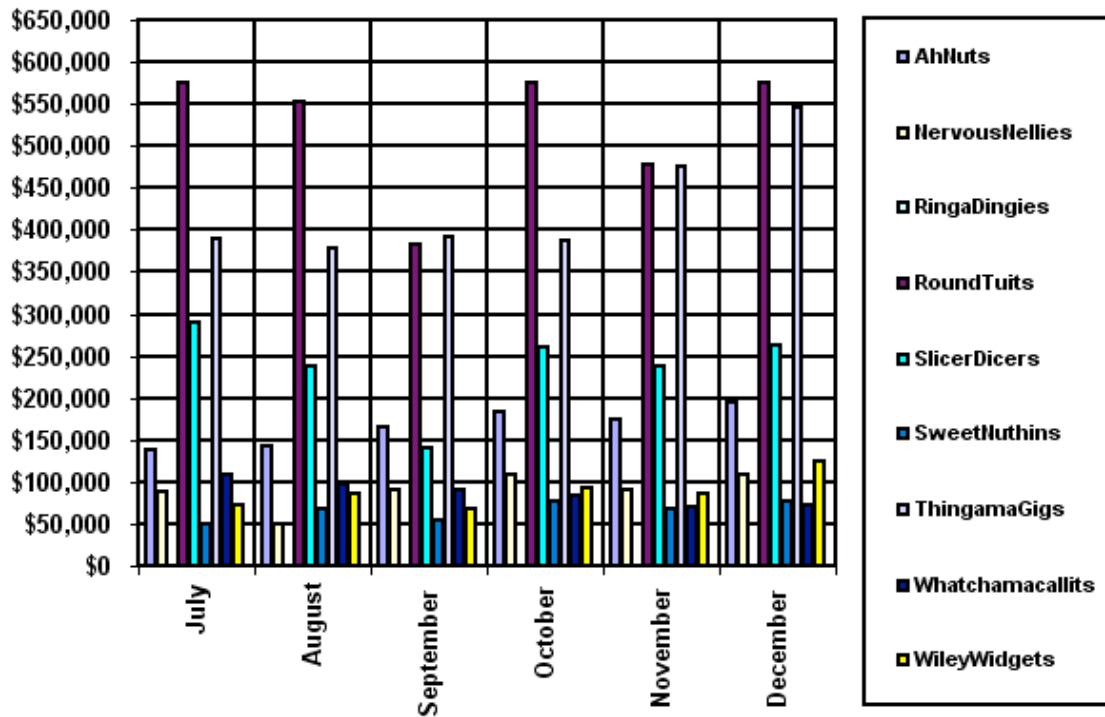

Problematic design

Sales of SlicerDicers Compared to Other Products

July - December, 2003

(SlicerDicers' sales are displayed as black reference lines of 100%; the red bars represent the average monthly sales percentage for July through December.)

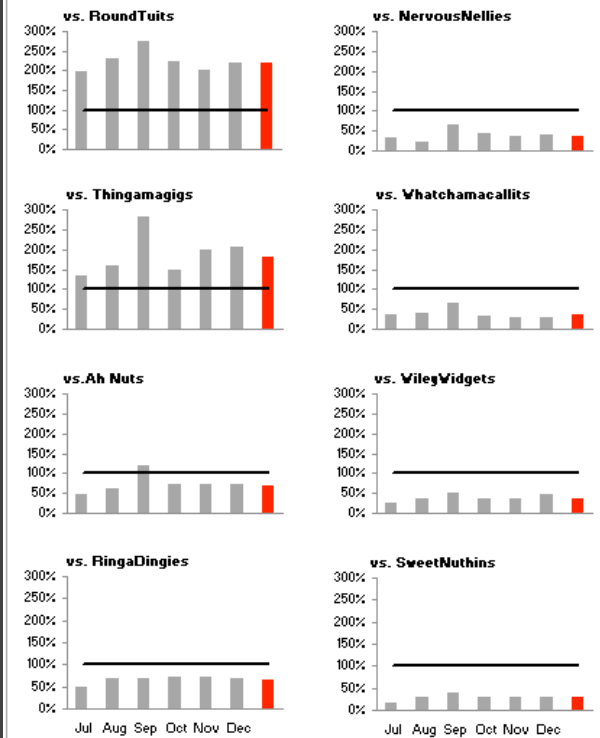

Redesign

Visualization Software

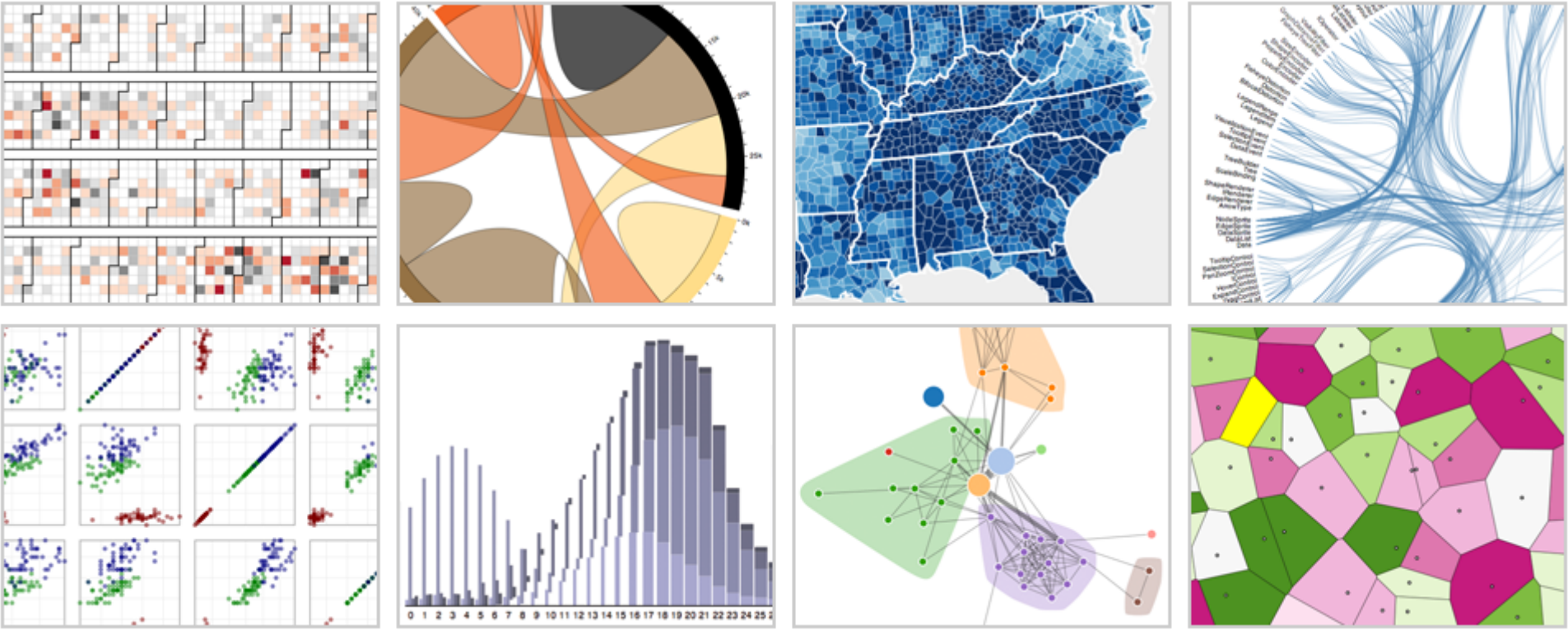

D3: Data-Driven Documents

Graphical Perception

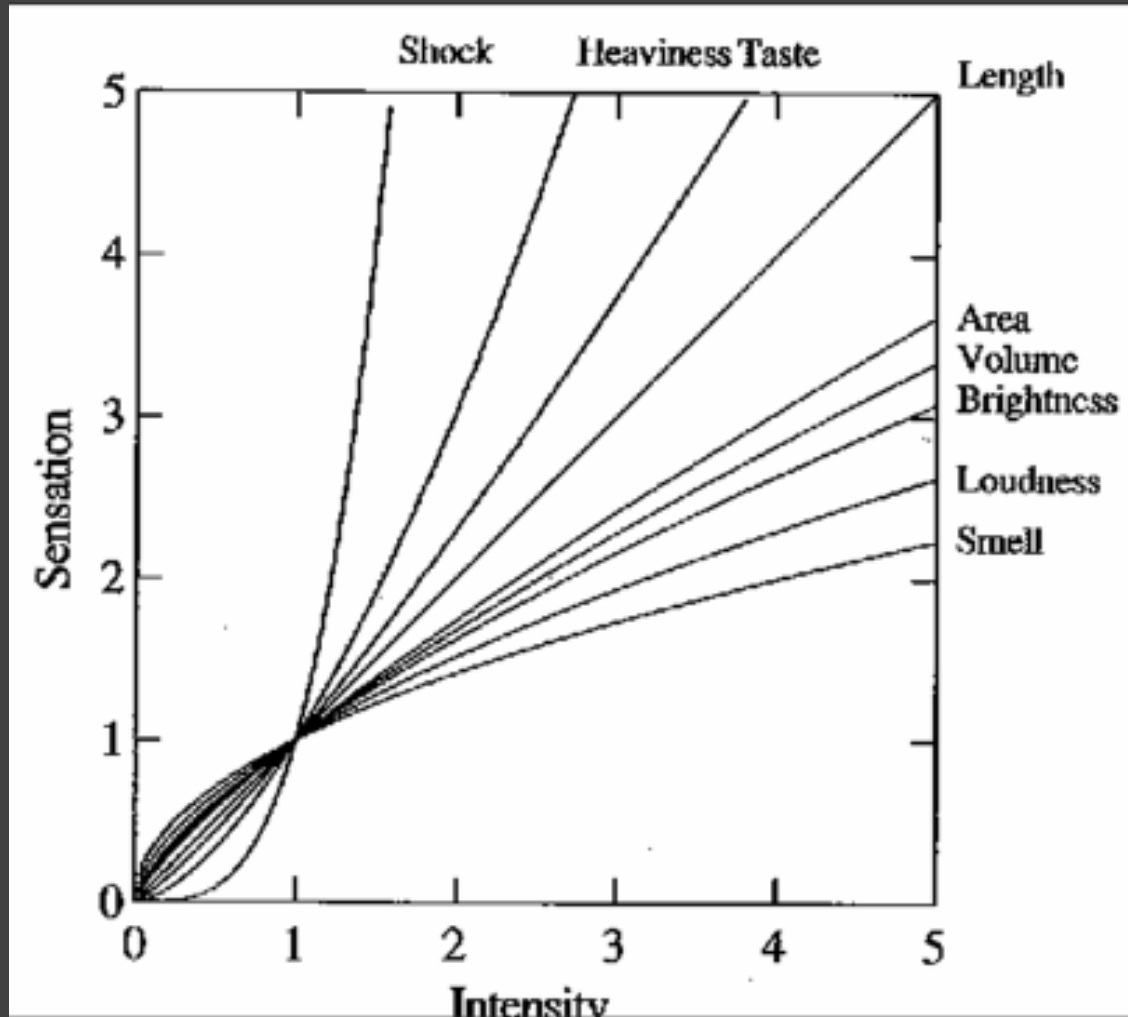

The psychophysics of sensory function [Stevens 61]

Color

CIE 1931 xy chromaticity diagram

showing the gamut of the sRGB and Adobe RGB color spaces including the Planckian locus, with temperatures indicated. Wavelengths of monochromatic light are shown in blue.

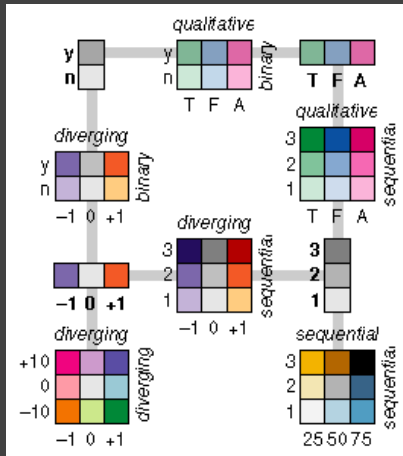
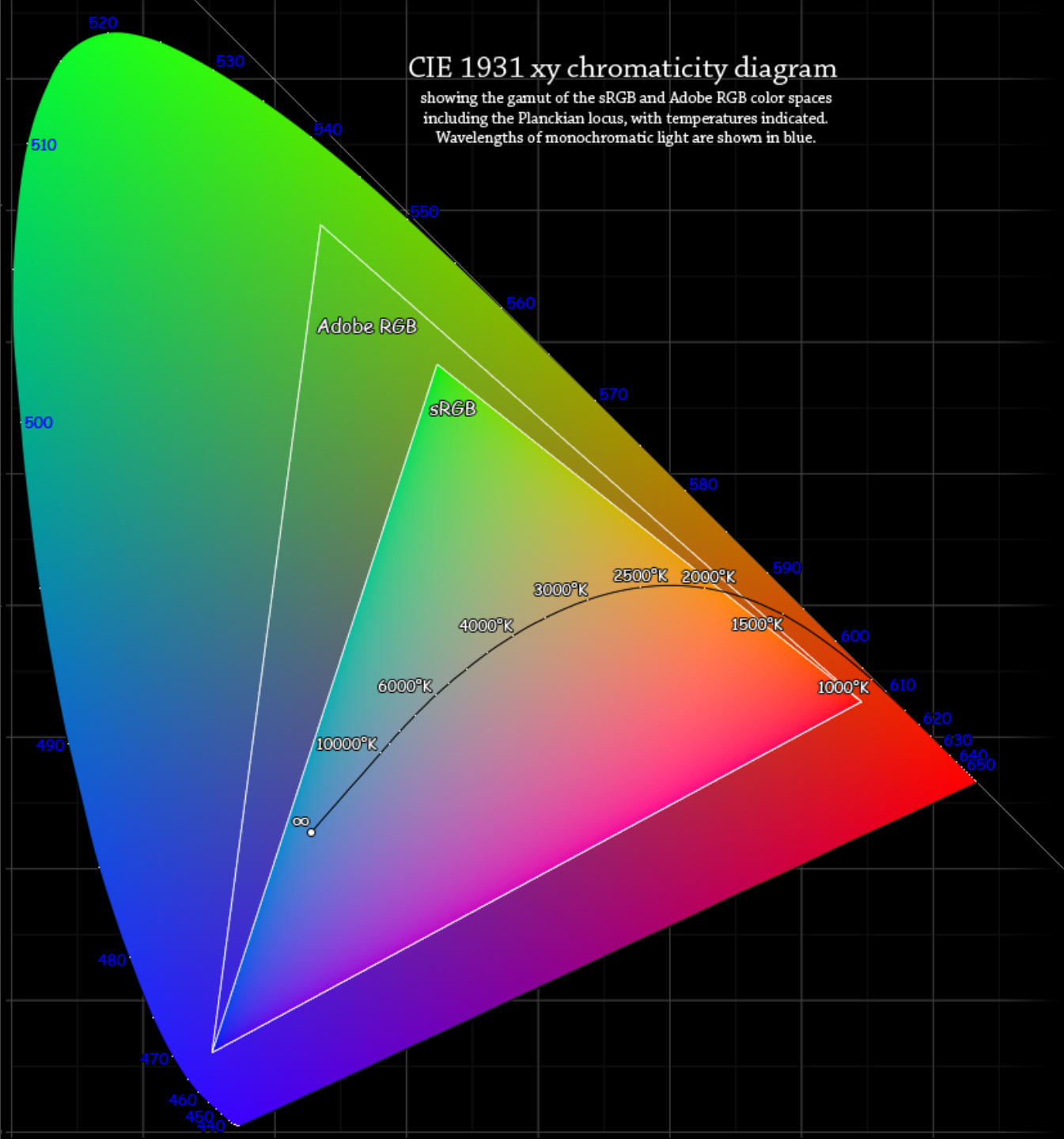

Color Brewer

Interaction

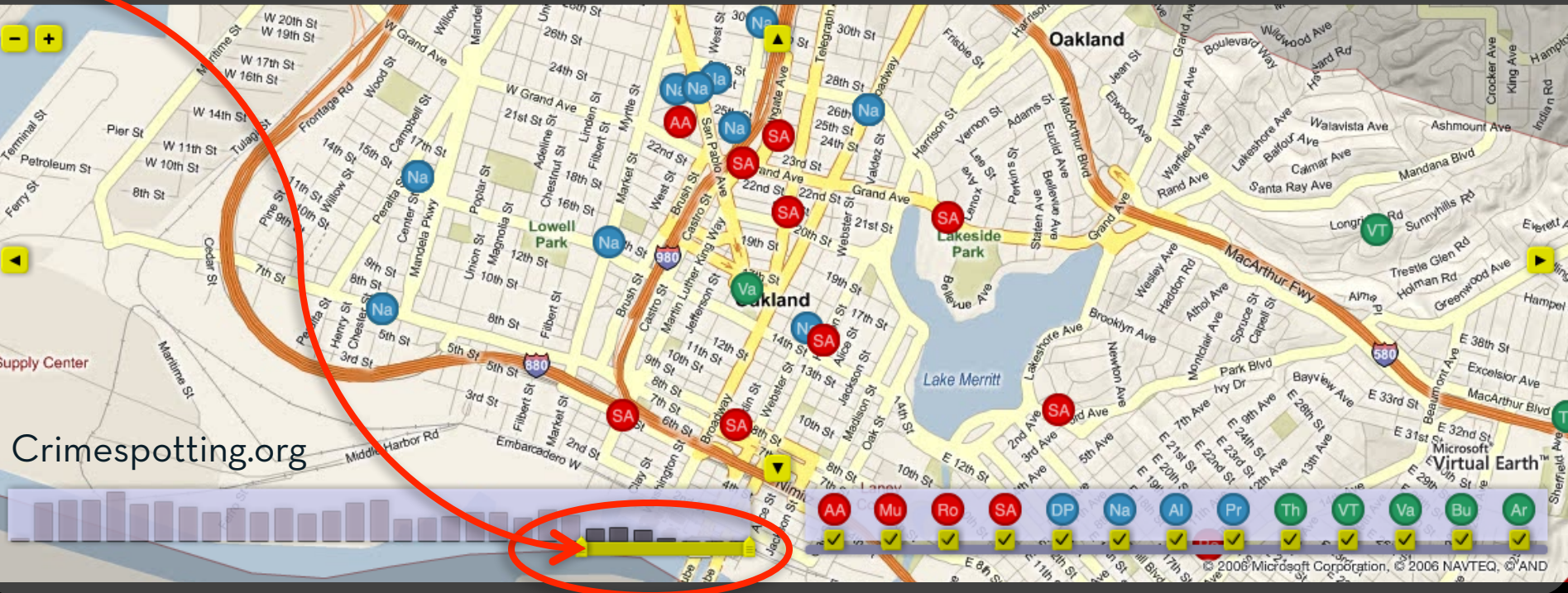
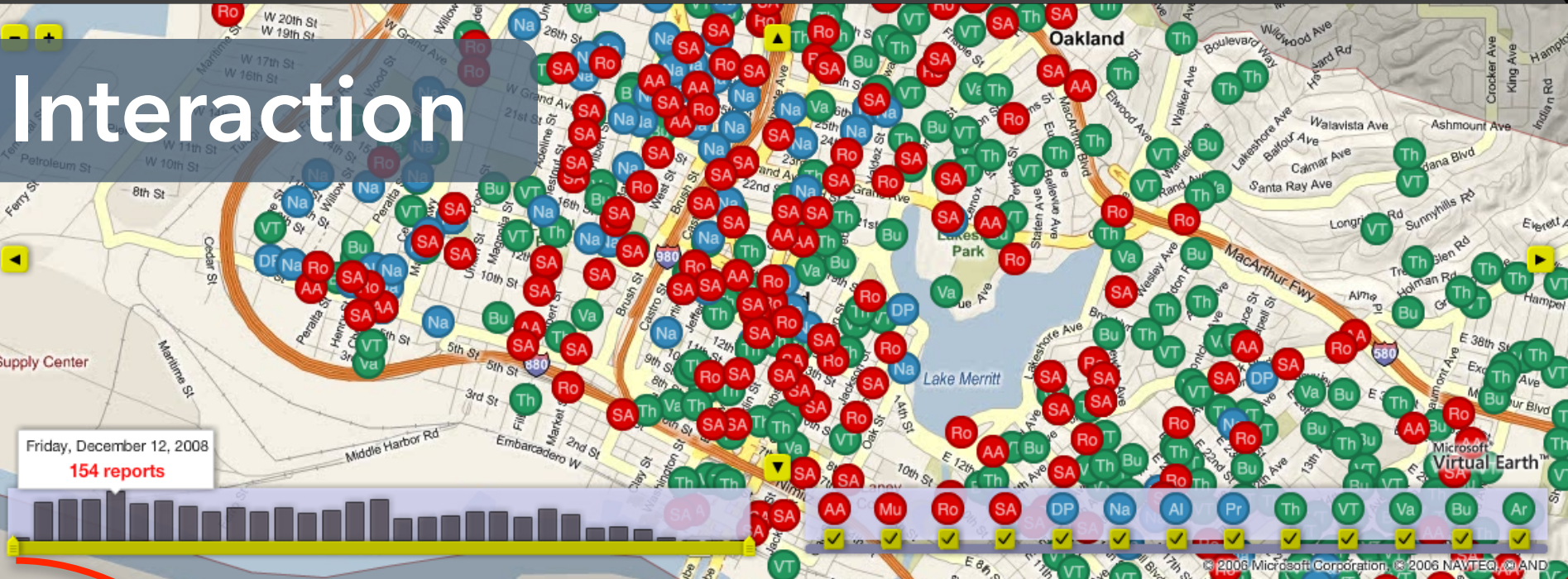

Animation

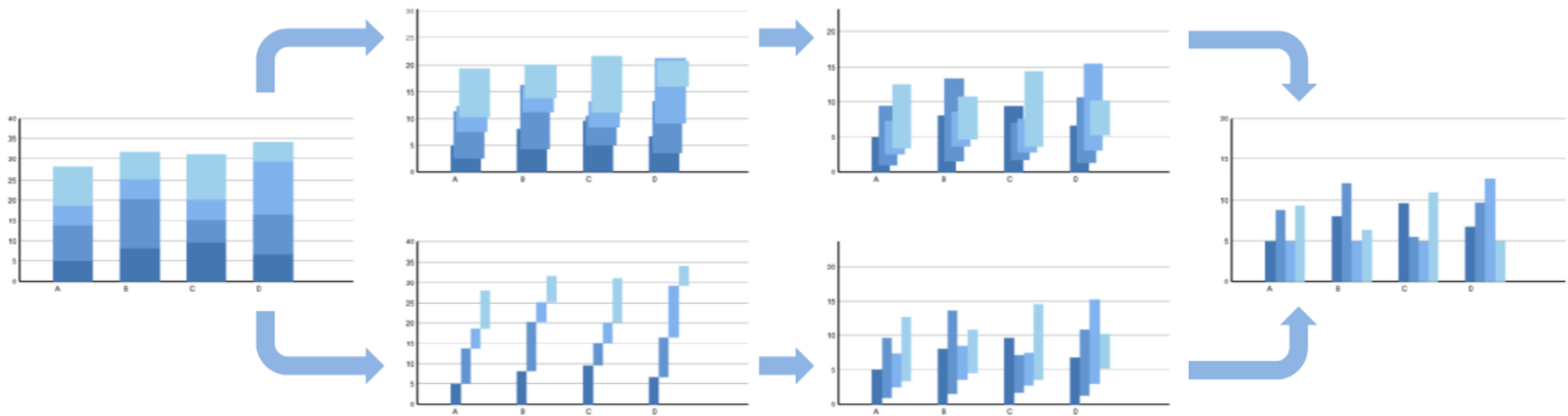

Animated transitions in statistical data graphics [Heer & Robertson 07]

Mapping & Cartography

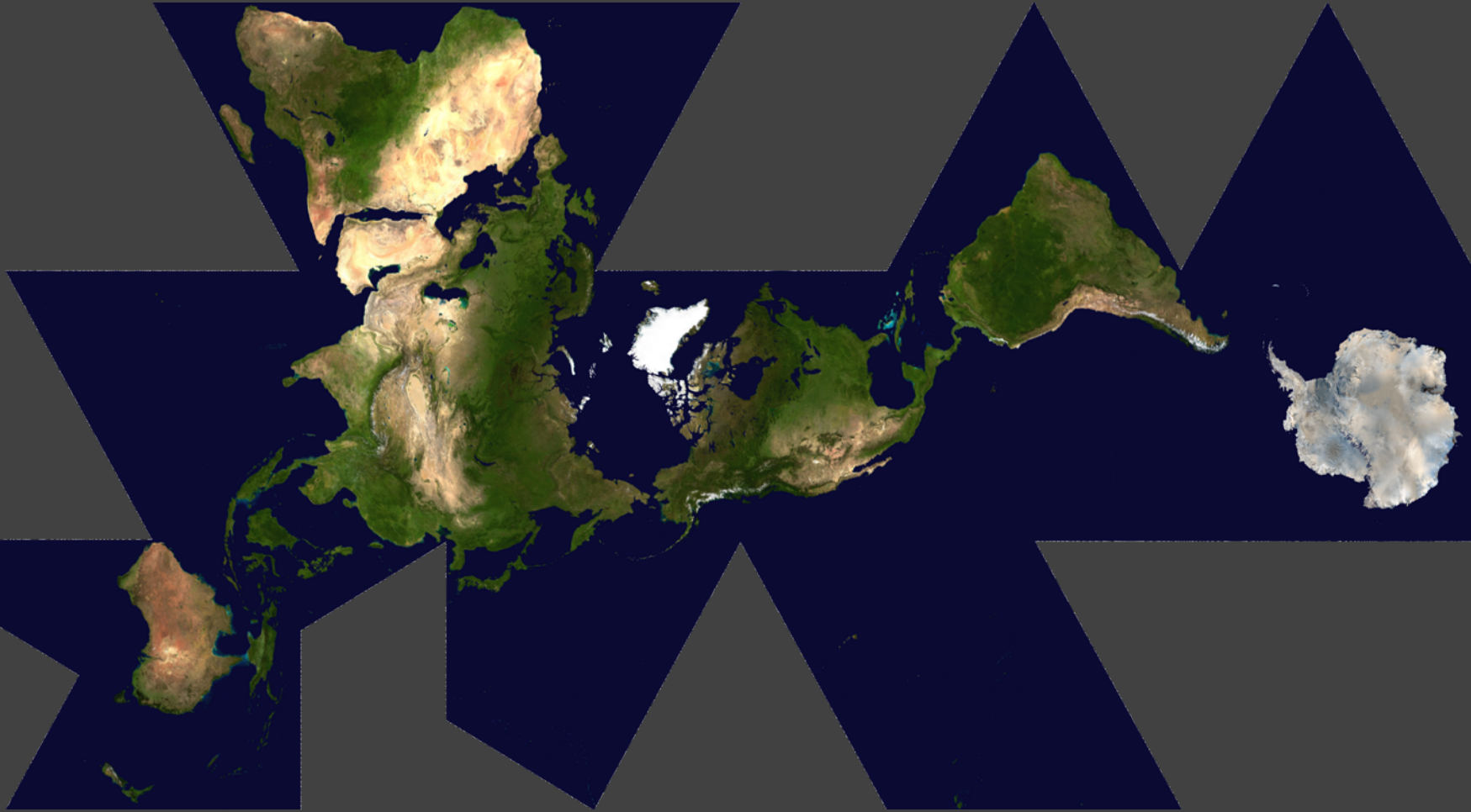

Dymaxion Maps [Fuller 46]

Graphs and Trees

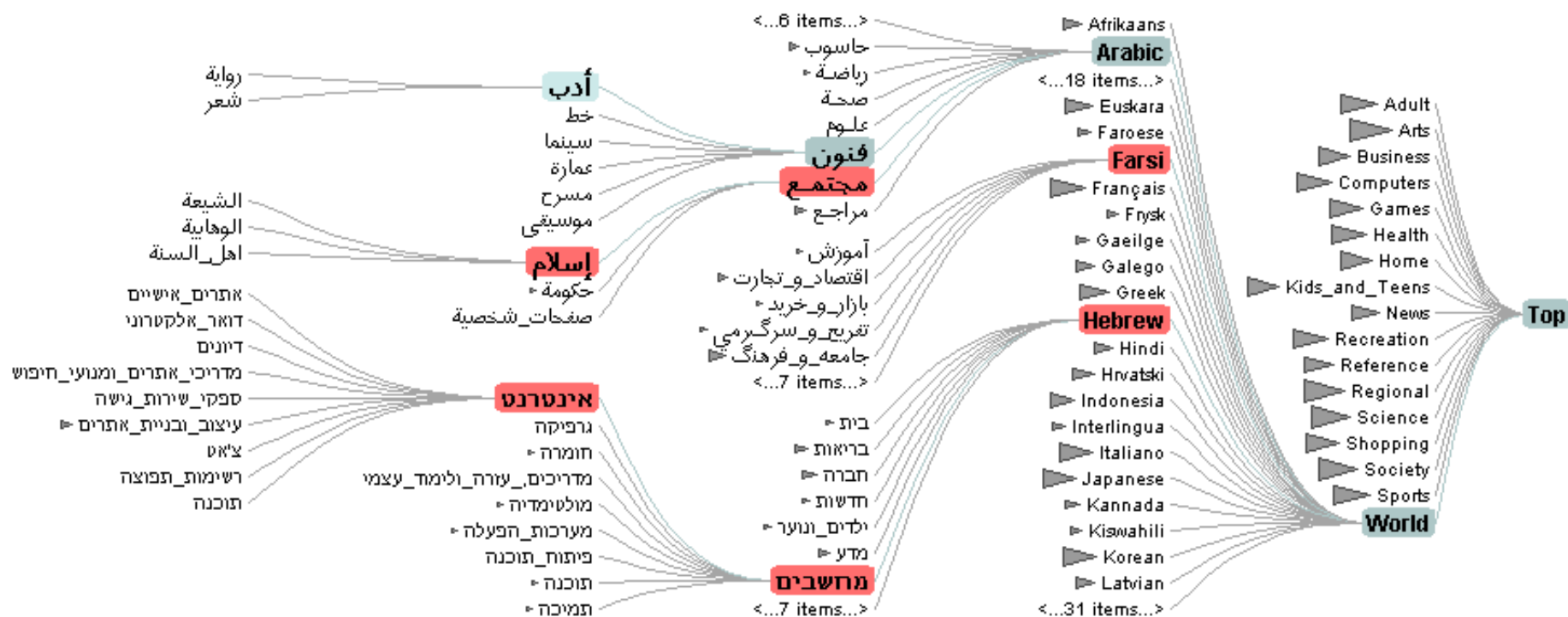

Degree-Of-Interest Trees [Heer & Card 04]

Graphs and Trees

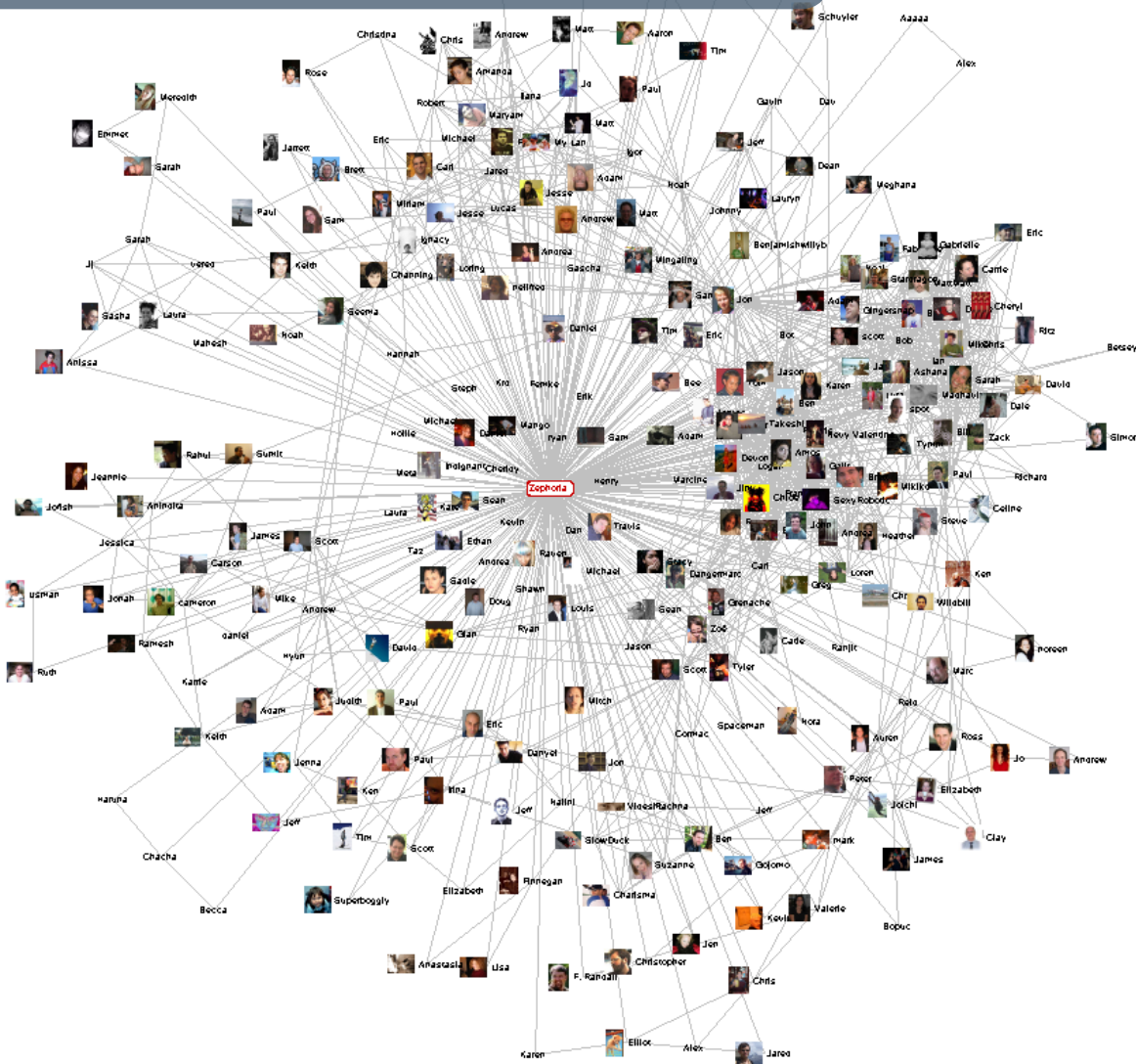

Zephoria

User ID	21721
Friends	<input type="checkbox"/> 266
Age	??
Gender	<input type="checkbox"/> Female
Status	<input type="checkbox"/> Single
Location	San Francisco, CA
Hometown	Lancaster, PA
Occupation	researcher: social networks, identity, context
Interests	apophenia, observing people, culture, questioning power, reading, buddhism, ipseity, computer-mediated communication, social networks, technology, anthropology, stomping
Music	psytrance/goa/trance [Infected Mushroom, Son Kite... Iboga/Digital Structures], Ani Difranco, downtempo, Thievery Corporation, Beth Orton, Morcheeba, Ween, White Stripes
Books	Authors: Erving Goffman, Stanley Milgram, Jeanette Winterson, Eric Schlosser, Leslie Feinberg, Dorothy Allison, Italo Calvino, Hermann Hesse
TV Shows	??
Movies	Koyaanisqatsi, Amelie, Waking Life, Tank Girl, The Matrix, Clockwork Orange, American Beauty, Fight Club, Boys Don't Cry
Member Since	??
Last Login	2003-10-21
Last Updated	2003-10-21
About	[Some know me as danah...]

I'm a geek, an activist and an academic, fascinated by people and society. I see life as a very large playground and enjoy exploring its intricacies. I revel in life's chaos, while simultaneously providing my own insane element.

My musings:
<http://www.zephoria.org/thoughts/>

Want to Meet Someone who makes life's complexities seem simply elegant.

Text Visualization

Visualizations: Word tree / Alberto Gonzales

Creator: Martin Wattenberg

Tags:

explore

- visualizations
- data sets
- comments
- topic hubs

participate

- create visualization
- upload data set
- create topic hub
- register

learn more

- quick start
- visualization types
- data format & style
- about Many Eyes
- FAQ
- blog

contact Us

- contact
- report a bug

legal

- terms of use

Popular Dataset Tags

- 2007 2008 bible blog
- books census crime
- education eharmony
- election energy food
- health inauguration
- internet ireland literature
- lyrics media music
- network obama
- people politics
- population
- president prices religion
- social

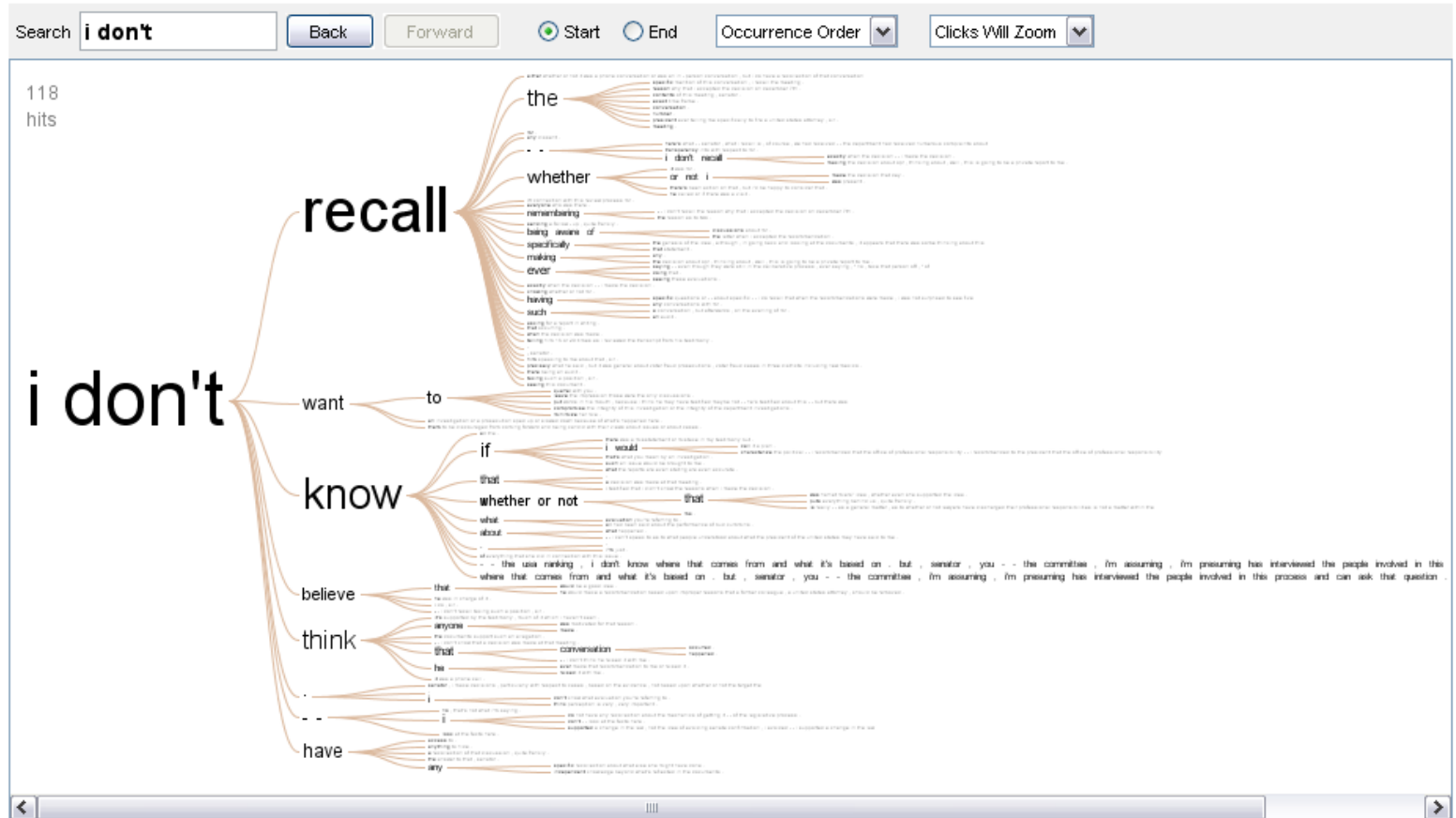

Data file: [Word in testimony from Gonzales, 4/19/2007](#) Data source: CQ Transcript Wire via the Washington Post This data set has not yet been rated

Comments (4)

currently showing

This visualization has 4 positive and 0 negative

Collaborative Analysis

Where have all the dentists gone?

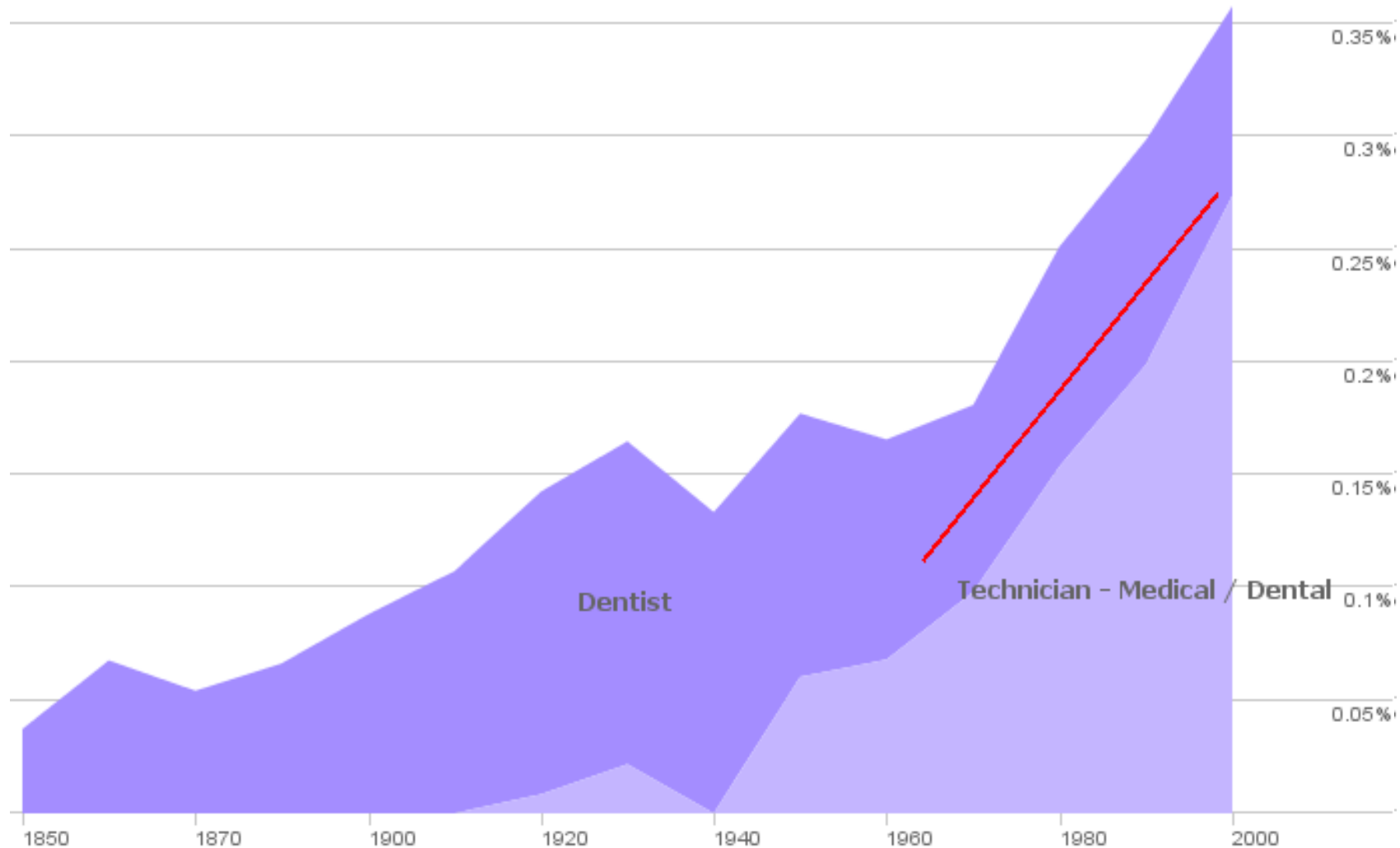

The Future of Visualization

Where is more work required?

What emerging technologies and societal trends will impact visualization design?

What did you find most difficult in creating visualizations and designing techniques?

Course Evaluation

Course Evaluation

Official campus course evaluation

Distributed and completed online.

Your opinion is valued!

<https://uw.iasystem.org/survey/146030>

Thanks for a great quarter!

Thank You!

