

Getting Started with Maya 7



Legal Notices

Maya®, Version 7

© Copyright 1997-2005 Alias Systems Corp. ("Alias") and its licensors. All rights reserved.

Protected by U.S. patents 6,414,700; 5,818,452; 5,777,619; 5,764, 233; 5,808,625; 6,348,924; 6,204,860; 6,266,071; 6,525,735; 5,929,864; 6,317,128; 6,118,427; 5,847,716; 6,462,740; 6,246,416; 6,549,212; 5,889,528; 6,211,882; 5,809,219; 6,618,063; 5,926,178; 5,689,667; 6,389,154; 6,553,337; 6,850,638; 6,587,105; 6,307,555; 5,852,450; 5,990,908; 6,414,700; 6,025,852; Patents Pending.

Graph Layout Toolkit © Copyright 1992-2003. Tom Sawyer Software, Berkeley, California. All rights reserved.

Mozilla Open Source Project © Copyright 1998-2004 by Contributors to the Mozilla codebase under the Mozilla Public License. Source code may be found at <http://222.mozilla.org/source.html>. The Mozilla software is distributed under the Mozilla Public License on an "AS IS" basis, WITHOUT WARRANTY OF ANY KIND. The Mozilla Public License may be found at www.mozilla.org/MPL/. All rights reserved.

Portions relating to JPEG © Copyright 1991-1998 Thomas G. Lane. All rights reserved. This software is based in part on the work of the Independent JPEG Group.

Portions relating to TIFF © Copyright 1997-1998 Sam Leffler. © Copyright 1991-1997 Silicon Graphics, Inc. All rights reserved.

The Tiff portions of this software is provided by the copyright holders and contributors "as is" and any express or implied warranties, including, but not limited to, the implied warranties of merchantability and fitness for a particular purpose are disclaimed. In no event shall the copyright owner or contributors of the TIFF portions be liable for any direct, indirect, incidental, special, exemplary, or consequential damages (including, but not limited to, procurement of substitute goods or services; loss of use, data, or profits; or business interruption) however caused and on any theory of liability, whether in contract, strict liability, or tort (including negligence or otherwise) arising in any way out of the use of the TIFF portions of this software, even if advised of the possibility of such damage.

Portions relating to the implementation of the Edge Detection and Image SegmentatiON (EDISON) System are provided "AS IS". More information may be found at <http://www.caip.rutgers.edu/riul/research/code.html>.

Portions of the subdivision surface implementation technology incorporate the use of the Pixar Subdivision Surface Patents.

Alias, the swirl logo and Maya are registered trademarks of Alias Systems Corp. in the United States and/or other countries. Adobe, Illustrator and Photoshop are either registered trademarks or trademarks of Adobe Systems Incorporated in the United States and/or other countries. The Ravix logo is a trademark of Electric Rain, Inc.

All documentation ("Documentation") is copyrighted © 2005 Alias and contains proprietary and confidential information of Alias. The Documentation is protected by national and international intellectual property laws and treaties. All rights reserved. Use of the Documentation is subject to the terms of the license agreement that governs the use of the software product to which the Documentation pertains ("Software"). The authorized licensee of the Software is hereby authorized to print no more than one (1) hardcopy of any Documentation provided in digital format per valid license of the Software held by such licensee. Except for the foregoing, the Documentation may not be translated, copied or duplicated in any form (physically or electronically), in whole or in part, without the prior written consent of Alias.

Alias, the swirl logo, FBX and Maya are registered trademarks and the Maya logo, Conductors, Maya Trax, IPR and MEL are trademarks of Alias in the United States and/or other countries worldwide. SGI, IRIX, OpenGL and Silicon Graphics are registered trademarks of Silicon Graphics, Inc. in the United States and/or other countries worldwide. mental ray and mental images are registered trademarks of mental images GmbH & CO. KG. in the United States and/or other countries. Macromedia, Director, Shockwave, Lingo and Macromedia Flash are trademarks or registered trademarks of Macromedia, Inc. Wacom is a trademark of Wacom Co., Ltd. NVIDIA is a registered trademark and Geforce is a trademark of NVIDIA Corporation. Linux is a registered trademark of Linus Torvalds. Intel and Pentium are registered trademarks of Intel Corporation in the United States and other countries. Red Hat is a registered trademark of Red Hat, Inc. ActiveX, Microsoft and Windows are either registered trademarks or trademarks of Microsoft Corporation in the United States and/or other countries. Apple, Mac, Macintosh and QuickTime are trademarks of Apple Computer, Inc., registered in the United States and other countries. Adobe, Illustrator, Photoshop and Acrobat are either registered trademarks or trademarks of Adobe Systems Incorporated in the United States and/or other countries. UNIX is a registered trademark of The Open Group. AutoCAD, Discreet, Inferno and Flame are either registered trademarks or trademarks of Autodesk, Inc./Autodesk Canada, Inc. in the USA and/or other countries. OpenFlight is a registered trademark of MultiGen Paradigm Inc. Java is a registered trademark of Sun Microsystems, Inc. RenderMan is a registered trademark of Pixar Corporation. Softimage is either a registered trademark or trademark of Avid Technology, Inc. in the United States and/or other countries. SUSE is a trademark of SUSE LINUX Products GmbH, a Novell business. FLEXIm is a registered trademark of Macrovision Corporation. Safari is a trademark of Apple Computer, Inc. KDE and K Desktop Environment are trademarks of KDE e.V. GNOME & the GNOME logo are registered trademarks or trademarks of GNOME Foundation. All other trademarks mentioned herein are the property of their respective owners.

All images © Copyright Alias unless otherwise noted. All rights reserved.



ALIAS ■ 210 KING STREET EAST ■ TORONTO, CANADA M5A 1J7

Table of Contents

1 Introduction	17	
About the Getting Started lessons	18	
Before you begin the Getting Started lessons	19	
Installing Maya	19	
Conventions used in this book	20	
Using the Getting Started lesson files	21	
Using the Maya Help	22	
Additional learning resources	27	
Restoring default user settings	28	
2 Maya Basics	31	
Preparing for the lessons	31	
Lesson 1	An overview of the Maya user interface	33
Starting Maya	33	
The Maya interface	34	
Saving your work	44	
Exiting Maya	44	
Beyond the lesson	45	
Lesson 2	Creating, manipulating, and viewing objects	46
Creating a new scene	47	
Primitive objects	47	
The Toolbox: Layout shortcuts	49	
The Toolbox: Transformation tools	51	
The Channel Box	55	

Table of Contents

	Duplicating objects	56
	Creating a project	58
	Save your work	58
	Beyond the lesson	59
Lesson 3	Viewing the Maya 3D scene	61
	Camera tools	62
	Workflow overview	66
	Viewing objects in shaded mode	72
	Grouping objects	73
	The Hypergraph	74
	Selection modes and masks	78
	Pivot points	79
	Save your work	80
	Beyond the lesson	80
Lesson 4	Components and attributes	82
	Template display	82
	Components	84
	The Attribute Editor	87
	Surface materials	89
	Save your work	92
	Beyond the lesson	93
3 Polygonal Modeling		95
	Preparing for the lesson	96
Lesson 1	Modeling a polygonal surface	97
	Creating a foundation shape from a primitive	98

Table of Contents

	Splitting polygons	100
	Using the poly extrude manipulator	104
	Subdividing polygon faces	108
	Smoothing edges.	110
	Beyond the lesson	113
4	NURBS Modeling	115
	Preparing for the lessons	115
Lesson 1	Revolving a curve to create a surface	116
	Creating a profile curve	116
	Creating a revolve surface	118
	Editing a revolve surface	118
	Beyond the lesson	120
Lesson 2	Sculpting a NURBS surface	122
	Preparing a surface for sculpting.	122
	Basic sculpting techniques	125
	Additional sculpting techniques.	128
	Sculpting a nose	130
	Sculpting eye sockets	131
	Sculpting eyebrows	132
	Sculpting a mouth	133
	Sculpting other facial features	135
	Beyond the lesson	136
Lesson 3	Lofting curves to create a surface	138
	Creating profile curves for a surface	138
	Duplicating curves	140

Table of Contents

Lofting a surface	141
Modifying a primitive object	142
Using the Outliner to parent objects	143
Beyond the lesson	144
5 Subdivision Surfaces	147
Preparing for the lesson	147
Lesson 1 Modeling a subdivision surface	148
Creating a subdivision surface	148
Splitting a surface in polygon proxy mode	151
Extruding polygon faces	152
Deleting polygon faces	157
Subdivision surface levels	158
Refining surface components	160
Creating a crease in a subdivision surface	162
Beyond the lesson	164
6 Animation	165
Preparing for the lessons	165
Lesson 1 Keyframes and the Graph Editor	166
Setting the playback range	167
Setting keyframes	168
Using the Graph Editor	172
Changing the timing of an attribute	176
Fine tuning an animation	177
Deleting extra keyframes and static channels	179
Using Playblast to playback an animation	180

Table of Contents

	Beyond the lesson	181
Lesson 2	Set Driven Key	183
	Lesson setup	184
	Using Set Driven Key to link attributes	184
	Viewing the results in the Graph Editor	187
	Beyond the lesson	188
Lesson 3	Path animation	189
	Open the scene for the lesson	190
	Animating an object along a motion path	190
	Changing the timing of an object along a motion path	193
	Rotating an object along a motion path	200
	Blending keyframe and motion path animation	202
	Using Playblast to playback an animation	208
	Beyond the lesson	208
Lesson 4	Nonlinear animation with Trax	210
	Open the first scene for the lesson	211
	Creating clips with Trax	213
	Changing the position of clips with Trax	221
	Editing the animation of clips	223
	Reusing clips within Trax	225
	Soloing and muting tracks	229
	Scaling clips within Trax	230
	Open the second scene for the lesson	231
	Creating clips from motion capture data	233
	Extending the length of motion capture data	234

Table of Contents

	Redirecting the motion within a clip.	239
	Beyond the lesson	247
Lesson 5	Inverse kinematics	250
	Open the scene for the lesson	251
	Understanding hierarchies	252
	Viewing hierarchies using the Hypergraph	254
	Creating a skeleton hierarchy	255
	Parenting a model into a skeleton hierarchy.	259
	Applying IK to a skeleton hierarchy	263
	Creating a control object for an IK system	266
	Constraining an IK system	269
	Limiting the range of motion of an IK system	273
	Simplifying the display of a hierarchy.	281
	Applying parent constraints on an IK system	281
	Planning an animation for an IK system.	285
	Animating an IK system	288
	Beyond the lesson	293
7	Character Setup	295
	Preparing for the lessons	295
Lesson 1	Skeletons and kinematics	296
	Open the scene for the lesson	296
	Creating joints	297
	Adding joints to a skeleton	302
	Creating a skeleton hierarchy	304
	Forward and inverse kinematics	305
	Posing and animating using inverse kinematics	306

Table of Contents

	Posing and animating using forward kinematics	309
	Beyond the lesson	309
Lesson 2	Smooth skinning.	311
	Open the scene for the lesson	311
	Smooth binding a skeleton	312
	Skin weighting and deformations	314
	Modifying skin weights	315
	Influence objects	317
	Beyond the lesson	320
Lesson 3	Cluster and blend shape deformers.	322
	Open the scene for the lesson	322
	Creating a target object for a blend shape	323
	Creating a cluster deformer on a target object	324
	Editing cluster weights	326
	Creating a blend shape	330
	Refining deformation effects	332
	Adding target objects to an existing blend shape	333
	Beyond the lesson	338
8 Polygon Texturing		341
	Preparing for the lesson	342
Lesson 1	UV texture mapping	343
	Creating a cracker box model	344
	Applying a texture map to a polygon mesh	345
	Viewing UVs in the UV Texture Editor	351
	Mapping UV texture coordinates	355

Table of Contents

	Working with UVs in the UV Texture Editor	359
	Selecting UV components	359
	Sewing UVs	362
	Moving UV components	365
	Beyond the lesson	368
9	Rendering	371
	Preparing for the lessons	372
Lesson 1	Rendering a scene	373
	Open the scene for the lesson	374
	Creating shading materials for objects	375
	Refining shading materials for objects	379
	Maya renderers	384
	The Render View window	386
	Rendering a single frame using IPR	386
	Rendering using the Maya software renderer	392
	Batch rendering a sequence of animation frames	394
	Viewing a sequence of rendered frames	397
	Beyond the lesson	398
Lesson 2	Shading surfaces	400
	Open the scene for the lesson	401
	Assigning a shading material	402
	Modifying surface specularly	404
	Material types	405
	Assigning textures	406
	Using the Hypershade editor	410
	Creating a texture within the Hypershade editor	413

Table of Contents

	Modifying a bump texture	416
	Beyond the lesson	419
Lesson 3	Lights, shadows, and cameras	421
	Open the scene for the lesson	422
	Directional lights	423
	Spotlights	425
	Editing light attributes	428
	Shadows	431
	Creating additional cameras in a scene	433
	Animating camera moves	435
	Beyond the lesson	437
Lesson 4	Global Illumination	439
	Open the scene for the lesson	440
	Render the scene using raytracing	441
	Using the mental ray for Maya renderer	441
	Setting render settings for raytracing	442
	Setting the image size for rendering	443
	Turning on shadows	444
	Rendering the image	445
	Render the scene using Global Illumination	446
	Setting a panel layout for rendering	448
	Rendering the scene with Global Illumination	449
	Increasing the brightness of Global Illumination	450
	Adjusting the quality of Global Illumination	451
	Beyond the Lesson	456

Table of Contents

Lesson 5	Caustics	458
	Open the scene for the lesson	459
	Render the scene using raytracing	460
	Setting a panel layout for rendering	460
	Turning on shadows	461
	Using the mental ray for Maya renderer	462
	Setting the image size for rendering	463
	Setting render presets for raytracing	464
	Rendering the image	464
	Render the scene using caustics	466
	Rendering the scene with caustics	467
	Adjusting the refraction levels	469
	Increasing the brightness of caustics	470
	Adjusting the quality of caustics	471
	Beyond the Lesson	473
10 Dynamics	475
	Preparing for the lessons	475
Lesson 1	Particles, emitters, and fields.	476
	Creating an emitter	477
	Creating volume axis fields.	479
	Adjusting the velocity of moving particles.	485
	Setting the particle render type	486
	Adding dynamic attributes	487
	Adding per particle attributes	488
	Adding color to particles with a color ramp.	489
	Hardware rendering particles	492
	Beyond the lesson.	494

Table of Contents

Lesson 2	Rigid bodies and constraints	496
	Lesson setup	497
	Creating hinge constraints	499
	Running a dynamics simulation.	500
	Changing an active rigid body to passive	501
	Beyond the lesson	502
11	Painting	505
	Preparing for the lessons	506
Lesson 1	Painting in 2D using Paint Effects	507
	Painting strokes	507
	Modifying the default brush settings	510
	Modifying the canvas	512
	Modifying the colors of a preset brush.	513
	Editing strokes with tubes attributes	515
	Saving brush settings for future use	516
	Blending brushes.	517
	Smearing, blurring, and erasing paint	518
	Beyond the lesson	519
Lesson 2	Painting in 3D using Paint Effects	521
	Preparing for the lessons	522
	Brushes and strokes	522
	Rendering Paint Effects strokes	530
	Paint Effects on 3D objects	535
	Creating a surface to paint on.	535
	Painting on objects	539
	Using turbulence with brush stroke tubes	540

Table of Contents

	Using additional preset brushes	541
	Mesh brushes	544
	Converting mesh strokes to polygons	546
	Modifying a converted polygonal mesh	548
	Beyond the lesson	552
Lesson 3	Painting textures on surfaces	554
	Open the scene for the lesson	554
	Preparing for painting	555
	Painting with an Artisan brush	556
	Painting symmetrical strokes	558
	Using Flood All to apply a single color	559
	Brush shapes	560
	Painting with a Paint Effects brush	562
	Smearing and blurring	564
	Painting a bump map texture	565
	Beyond the lesson	567
12 Expressions	571
	Preparing for the lessons	572
Lesson 1	Creating a simple expression	573
	Creating expressions to control a single attribute	573
	Editing expressions	577
	Using expressions to control multiple attributes	578
	Linking multiple attributes on the same object	578
	Controlling attributes in two objects	579
	Beyond the lesson	579

Table of Contents

Lesson 2	Conditional expressions	582
	Creating a conditional expression	582
	Other conditional statement options	585
	Fixing a problem in an expression	587
	Using else statements	588
	Simplifying expressions	589
	Editing expressions to refine an animation	590
	Beyond the lesson	593
Lesson 3	Controlling particle attributes	594
	Creating particle objects	594
	Using creation expressions to set a constant color	595
	Using runtime expressions	597
	Modifying runtime expressions	598
	Beyond the lesson	600
13 MEL		601
	Preparing for the lesson	601
Lesson 1	MEL basics	602
	Using MEL commands	602
	Creating a Shelf button for a MEL command	604
	Downloading Alias MEL scripts	608
	Creating a user interface slider using a MEL script	610
	Beyond the lesson	613
Index		617

Table of Contents

Getting Started with Maya
16

1 Introduction

Welcome to Alias® Maya®, the world's leading software application for 3D digital animation and visual effects. Maya provides a comprehensive suite of tools for your 3D content creation work ranging from modeling, animation, and dynamics through to painting and rendering to name but a few.

With Maya, you can create and edit 3D models in a variety of modeling formats and animate your models using Maya's suite of animation tools. You can create convincing visual simulations of rigid and soft body objects interacting in the physical world using the computational dynamics and particles tools. Maya also provides a range of tools to allow you to render your animated 3D scenes to achieve photo realistic imagery and animated visual effects.

The Maya software interface is fully customizable for those users who require the ability to maximize their productivity. Maya allows users to extend their functionality within Maya by providing access to MEL™ (Maya Embedded Language). With MEL, you can customize the user interface and write scripts and macros. In addition, a full Application Programmers Interface (API) is available to enhance the power and functionality of Maya.

The content creation power of Maya is provided to users in an integrated software application that is designed to enhance user productivity and ease of use.

The goal of this manual is to assist you in getting started with Maya as you embark upon your learning path.

This chapter provides the following information:

- About Getting Started with Maya—Contents of the Getting Started with Maya manual.
- Prerequisites—What you should know before using Getting Started with Maya.
- Installing Maya—Information on installing Maya.
- Using the Getting Started with Maya files—How to copy the files provided on CD-ROM for the Getting Started with Maya lessons.
- Maya Help—Outlines the help resources provided with your Maya software.
- Additional Resources—Outlines resources beyond what is included with your Maya software.

1 | Introduction

> About the Getting Started lessons

About the Getting Started lessons

Getting Started with Maya introduces the different areas of Maya in a set of brief lessons. The lessons are designed to let you learn these modules at your own pace.

If you are new to Maya, this manual gets you started on your learning path. If you are an existing user or are transitioning from another 3D software application, *Getting Started with Maya* provides a starting point for understanding features you haven't yet had time to learn.

If you are a user of Maya® Unlimited™ you can learn about the features of your software by going through the lessons in *Getting Started with Maya Unlimited* which accompanies your software package. If you are new to Maya, we recommend that you begin with the lessons contained within Getting Started with Maya.

Getting Started with Maya is not meant to replace the documentation that comes with the Maya software. Only the commands and options used in the lessons are explained in this manual. You will find the Maya Help provides an excellent companion reference to the lessons and much more.

Many of the lessons in *Getting Started with Maya* contain one or more separate lessons that provide step-by-step instructions for creating or accomplishing specific tasks within Maya. You can follow the lessons in this book from start to finish or complete only the lessons that correspond to your interests and needs.

We recommend that any new Maya user begin by completing the following:

- Viewing the Essential Skills Movies that are available when you first start Maya.
- Completing the Maya Basics lessons (Chapter 2) which introduce many fundamental concepts and skills related to the Maya user interface.

Getting Started with Maya is also available for use within the Maya Help. This version of Getting Started with Maya contains Apple® QuickTime® movies for some of the lessons that supplement the printed version of the manual.

The Maya Help version of Getting Started with Maya includes an additional lesson chapter that is not available in the printed version of this manual. The additional lesson chapter is called *Expressions*.

To use the lessons from the Maya Help

- 1 In Maya, select Help > Tutorials.
The Maya Help window displays the *Getting Started with Maya* lessons.
- 2 Click the tutorial you want to work through.
The Maya Help displays the associated lessons for that tutorial.

Before you begin the Getting Started lessons

Before beginning *Getting Started with Maya*, you should have a working knowledge of your computer's operating system. You should know how to use a mouse, select menus, and enter text and commands from your keyboard. You should also know how to open and save files, copy files from a CD-ROM to your hard drive, and be able to navigate your computer operating system's file browser.

If you require an overview or review of these techniques, we recommend that you refer to the documentation that came with your particular computer and operating system.

If you are new to 3D computer graphics and animation, you may want to obtain *The Art of Maya* (ISBN: 1-894893-82-4, available from the Alias online store). It explains many concepts and techniques that are unique to the world of 3D computer graphics as they relate to Maya.

Installing Maya

You must have Maya installed and licensed on your computer system to successfully complete the lessons in this manual. To operate Maya on your computer you must be running a qualified Microsoft® Windows®, Linux®, or Apple® Mac OS® X operating system with the recommended minimum memory and storage requirements. Maya requires a three button mouse to access its full functionality for menus, commands, and 3D viewing.

For complete instructions on qualified hardware and operating systems, as well as installation and licensing of the Maya software, please refer to the *Installation and Licensing* manual that came with your Maya software or see the Support section of our Web site at www.alias.com.

1 | Introduction

> Conventions used in this book

Conventions used in this book

Some important conventions used throughout Getting Started with Maya are explained here.

Maya is available for use on a wide range of operating systems. Any differences between operating systems when operating Maya are identified throughout this book in the following ways:

(Windows), (Mac OS X), (Linux)

The screen illustrations and examples within Getting Started with Maya vary among the Windows, Mac OS X, and Linux operating systems. Maya's interface is generally consistent across these systems.

When instructed to select a menu within Maya we use the following convention:

- Menu > Command (For example, File > New Scene)



When you are instructed to select the option box for a particular menu item within Maya, we use the following convention:

- Menu > Command > Option (For example, Create > NURBS > Primitives > Sphere >)

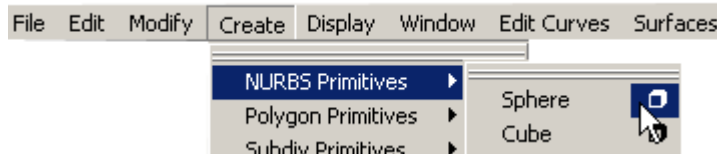

Using the Getting Started lesson files

Some of the Getting Started with Maya lessons have accompanying Maya files that were created for use with the lessons. These files are contained on the *Maya Documentation, Lessons, and Extras* CD-ROM which is included with your Maya software package. To use the lesson files, do one of the following:

- Open the Getting Started with Maya lesson files directly from the *Maya Documentation, Lessons, and Extras* CD-ROM.
- Copy the Getting Started with Maya lesson files to your computer's hard drive and then open them from your hard drive.

To open the lesson files from your CD-ROM drive

- 1** Insert the *Maya Documentation, Lessons, and Extras* CD-ROM into your drive.
- 2** Within Maya, select File > Open Scene.
- 3** Navigate to the CD-ROM drive, locate the Getting Started with Maya folder, and select it.
- 4** Double-click on the Getting Started with Maya lessons folder to view its contents.
- 5** Double-click the specific lesson folder and required file to open it in Maya.

To copy the lesson files from the *Maya Documentation, Lessons, and Extras* CD-ROM

- 1** Insert the *Maya Documentation, Lessons, and Extras* CD-ROM into your drive.
- 2** From the CD-ROM, copy the Getting Started with Maya folder to your computer into the following directory:

(Windows) drive:\Documents and Settings\username\
My Documents\maya\projects

(Mac OS X) Users/username/Library/Preferences/Alias/maya/
projects

(Linux) ~username/maya/projects

When you are asked to open specific lesson files, open the Getting Started with Maya lessons that you have copied to the *projects* directory.

1 | Introduction

> Using the Maya Help

Using the Maya Help

Your Maya software application comes with a comprehensive set of documentation resources.

Essential Skills Movies

The first time you start Maya, the Essential skills movies window displays in Maya. Watch these movies to learn about the skills you need to master when you first use Maya.



To play the Essential Skills Movies

- 1** In the Essential Skills Movies window, click the buttons to play the movie. Your computer launches its default multimedia player and your chosen movie begins to play.
- 2** Click your multimedia player's controls to start, stop, and pause the movie.
- 3** To view the online help of your multimedia player, select its help menu.

Getting Started with Maya

To close the Essential Skills Movies window or the multimedia player

- 1** To close the Essential Skills Movies window, click the close box in the upper right corner of the window.
If you do not want to have this dialog box automatically display when you start Maya, turn on the *Don't show this at startup* check box.
- 2** To close the multimedia player, select File > Exit or click the close box in the upper right corner of the window. (This instruction may vary depending upon which multimedia player is used)

If you want to watch the movies in the future

- In Maya, select Help > Learning Movies.
The Essential Skills Movie window appears.

Maya Help

Your Maya software application comes installed with Maya technical documentation that assists you in learning the Maya software. The Maya Help is HTML-based, structured by module, fully searchable, and is displayed using your computer's web browser.

The Maya Help is topic based and displays the major functionality categories for Maya. The Maya Help can assist you in finding reference information about particular topics, how to perform specific tasks, and MEL™ command references.

To launch the Maya Help

- Select Help > Maya Help.
The Maya Help appears in a separate browser (depending on your user preference settings)

To obtain help on a particular Maya topic

- In the Maya Help window, click the name of the Maya topic you want information about (for example, Animation, Dynamics, MEL commands, etc.).
The Maya Help displays the associated sub-topics and categories associated with the name you selected.

1 | Introduction

> Using the Maya Help

Maya Index and search

You can search the Maya Help directly using the index and search capabilities. With these tools you find the Maya topic you're looking for by searching the topic word in an alphabetic list or by directly typing the topic word(s) into the search field and having the search tool find the documentation entries associated with it.

To use the Maya Index

- 1** In Maya, select Help > Maya Help.
The Maya index appears near the top of the Help window as a an alphabetic set of icons.
- 2** To view an index entry by alphabetic listing, click the letter icon that is associated with the first letter of your desired topic (for example: Click on D for Dynamics).
The Maya index displays all entries in the Maya Help that begin with the letter D in the left navigation pane.
- 3** Scroll through the alphabetic listing until you find the entry you are looking for using the scroll bar on the right side of the pane.
- 4** In the left navigation pane, click the entry you want.
The information related to that topic appears in the right pane.

To use the Maya Search

- 1** Select Help > Maya Help.
The Maya Help appears in a separate window (depending on your user preferences). You search for your topic by typing in a specific word that best represents the information you require.
- 2** In the Search text box at the top of the Maya Help window, type a word that best represents your search topic.
- 3** Click the magnifying glass icon to begin your search.
The search results appear in the left navigation pane, sorted by relevancy.
- 4** Click the appropriate search result in the left window.

The information related to that entry appears in the right window. By default, the search will find both topic related information as well as task based instructions and related Getting Started lessons.

Popup Help

Popup Help provides you with a quick method of identifying a particular tool or icon in the Maya user interface.

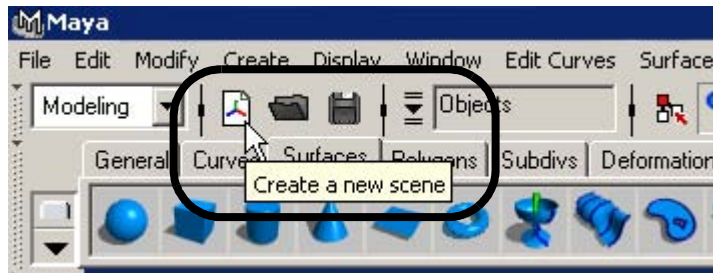

To use Popup Help

- Move your mouse cursor over an icon or button.
The name or description of it appears in a popup window directly over it.

To turn on the Popup Help if it does not appear

- 1** If you're operating Maya on a Windows or Linux operating system:
 - Select Window > Settings/Preferences > Preferences.
 - In the Preferences window, click the Help category and click the Tooltips Enable box in the Popup Help section so a check mark appears.
 - Click the Save button to close the Preferences window.
- 2** If you're operating Maya on a Mac OS X operating system:
 - Select Maya > Preferences.
 - In the Preferences window, click the Help category and click the Tooltips Enable box in the Popup Help section so a check mark appears.
 - Click the Save button to close the Preferences window.

1 | Introduction

> Using the Maya Help

Help Line

The Help Line at the bottom of Maya's window shows information about tools, menus, and objects. Like the Popup help, it displays descriptions when you move the mouse over icons and menu items. It also displays instructions when you select a tool. This is useful if you don't know or forget how to use a particular tool.

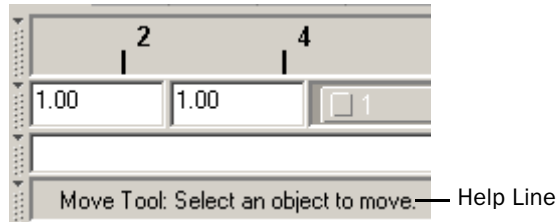

To use the Help Line

- Move your mouse cursor over an icon or button.

The icon or button name and instructions about how to use that tool appear in the Help Line.

Find Menu

The Find Menu lets you find the location of a particular menu item. Find Menu works only on the main menu items.

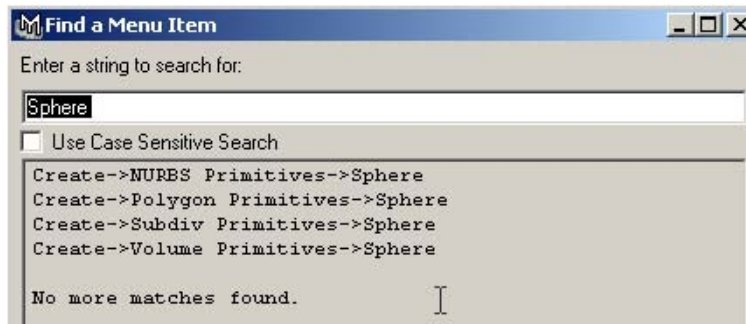

Getting Started with Maya

To find the location of a main menu item

- 1** Select Help > Find Menu.
The Find Menu window appears.
- 2** Type the menu item you want to locate in the text field, and press Enter (Windows and Linux) or Return (Mac OS X).
The possible locations for the main menu item display in the results field of the Find Menu window.

Maya Quick Reference

Maya Quick Reference is a printed reference that came with your Maya software package. It contains keyboard shortcut information that you will want to keep handy for quick reference.

Additional learning resources

Beyond the Maya Help resources within your Maya software, you can access the following resources to learn more about Maya or obtain technical assistance.

The Alias Web site

The Alias Web site contains a wealth of resources related to your Maya software and many other related products and services. You can view the Alias Web site at www.alias.com using your web browser.

Alias Education

Alias provides a range of products and services to help you get the most from your Maya software. You can purchase additional self-study learning materials or attend certified instructor led training courses at our Alias training facilities. Alias also runs Maya seminars at major computing trade shows and events. For more information, select the Education link on the Alias Web site.

1 | Introduction

- > Restoring default user settings

Alias Support

Alias Support delivers technical support services globally through telephone and email Hotline services, as well as online eSupport services. For more information, click the *Support Center* link from the Maya Help menu or click the *Support* link on the Alias Web site.

Restoring default user settings

If you have already used Maya or have a prior version of Maya installed, you should restore the default settings for Maya before you begin the lessons. This ensures that Maya appears and operates exactly as the lessons describe.

If you are an existing user of Maya we recommend that you save your existing preferences for later use prior to restoring the default user settings.

To save your existing custom user preferences

- 1 Ensure Maya is not running.
Each time you exit Maya it saves the configuration of most components of your user interface so it appears the same when you start it the next time. It writes the preferences to a directory called *prefs*. If you rename the *prefs* directory, your original preferences will be maintained and Maya will create a new *prefs* directory the next time it is run.
- 2 Rename your existing user preferences file to a name, for example, *myprefs*.
The *prefs* directory path is:
(Windows) `drive:\Documents and Settings\username\
My Documents\maya\7.0\prefs`
(Mac OS X) `Users/username/Library/Preferences/Alias/maya/7.0/
prefs`
(Linux) `~username/maya/7.0/prefs`
If you have a previous version of Maya installed, also rename that *prefs* directory to a new name such as *myprefs*. Maya will load older preferences if they exist from a previous version.
- 3 Start Maya and begin the Getting Started with Maya lessons.

1 | Introduction

> Restoring default user settings

To restore your custom user preferences after doing the lessons

- 1** Ensure Maya is not running.
- 2** Rename the previously changed preferences back to `prefs`.

1 | Introduction

- > Restoring default user settings

2 Maya Basics

Critical to learning any software program is some initial understanding of the basic concepts: how that software's world works and the fundamental skills you need to work in that world. If you have never used a three dimensional (3D) software application before, you may initially find Maya different compared to 2D applications.

If you are wondering “where do I begin?”, this chapter is the best place to start. We recommend that you complete the lessons in this chapter so the essential concepts and skills presented become familiar to you.

This chapter covers some of the fundamental concepts and skills for Maya in four lessons:

- “Lesson 1 An overview of the Maya user interface” on page 33
- “Lesson 2 Creating, manipulating, and viewing objects” on page 46
- “Lesson 3 Viewing the Maya 3D scene” on page 61
- “Lesson 4 Components and attributes” on page 82



Image created by: David Atkinson

Preparing for the lessons

To ensure the lessons work as described:

- Ensure Maya is installed and licensed on your computer.

If you have not installed Maya yet, refer to the *Installation and Licensing* manual that accompanies your Maya software package. It outlines the requirements for installing Maya and procedures for installation and licensing Maya on supported hardware platforms.

2 | Maya Basics

> Preparing for the lessons

- If you have never started Maya on your computer before, it will start for the first time using the default preference settings.
- If you have run Maya before, you should ensure that your Maya user preferences are reset to their default setting. This ensures that the lessons appear and work as described.

Refer to *Before you begin the lessons* section in the Introduction of this book for instructions on resetting user preferences to the default setting.

Lesson 1 An overview of the Maya user interface

Just as the driver of an automobile is familiar with the dashboard of their vehicle, it is important for you to become familiar with the Maya “dashboard.”

The Maya *user interface* refers to everything that the Maya user sees and operates within Maya. The menus, icons, scene views, windows, and panels comprise the user interface.

Through the Maya user interface you access the features and operate the tools and editors that allow you to create, animate, and render your three dimensional objects, scenes, and effects within Maya.

As you spend time learning and working with Maya, your knowledge of and familiarity with the user interface will increase until it becomes second nature.

In this lesson you learn how to:

- Start Maya on your computer.
- Use the Maya interface so that you can begin to understand where and how to access the critical tools to get started with Maya.
- Select the menu and icon sets within Maya.
- Learn the names of tools related to the icons in Maya.
- Create a new scene view.

This first lesson contains additional explanations of the tools and concepts compared to many of the lessons later in this manual. We suggest you take some time to review these explanations as they lay the foundation for understanding where things are in Maya.

Starting Maya

To start Maya on Windows

Do one of the following:

- Double-click the Maya icon on your desktop.

2 | Maya Basics

Lesson 1 > The Maya interface

- (Windows 2000 Professional) From the Windows Start menu, select Programs > Alias > Maya 7.0 > Maya (Complete or Unlimited).
- (Windows XP Professional) From the Windows Start menu, select All Programs > Alias > Maya 7.0 > Maya (Complete or Unlimited).

To start Maya on Mac OS X

Do one of the following:

- Double-click the Maya icon on your desktop.
- Click the Maya icon in the Dock.
- From the Apple Finder menu, select Go > Applications and then browse for the Maya icon and double-click it to start Maya.

To start Maya on Linux

Do one of the following:

- Double-click the Maya icon on your desktop.
- In a shell window, type: `maya`.

The Maya interface

Now that Maya is running, you first need to understand what you are seeing. There are a lot of items displayed in the Maya user interface.

The best way to begin is to learn the fundamental tools and then learn additional tools as you need them. Begin by learning some of the main tools.

2 | Maya Basics
Lesson 1 > The Maya interface

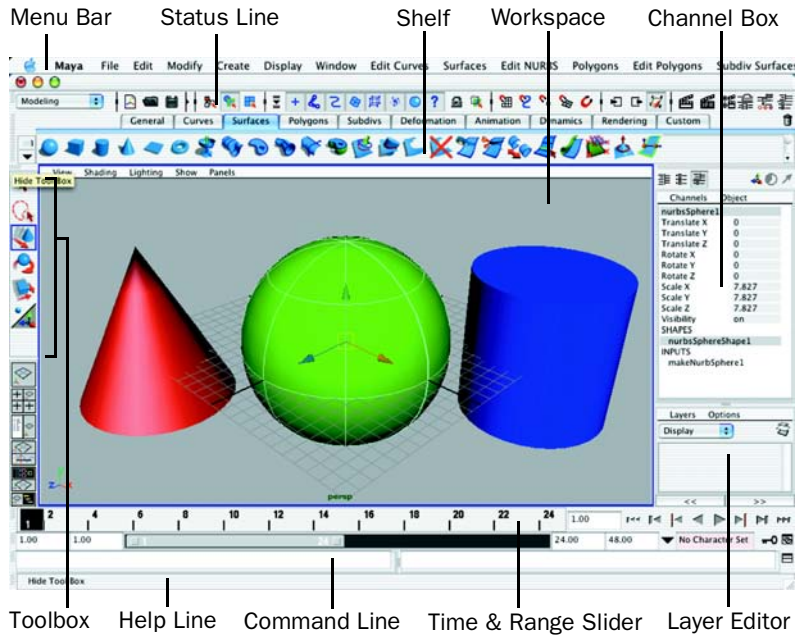

The Maya workspace

The Maya workspace is where you conduct most of your work within Maya. The workspace is the central window where your objects and most editor panels appear.

2 | Maya Basics

Lesson 1 > The Maya interface

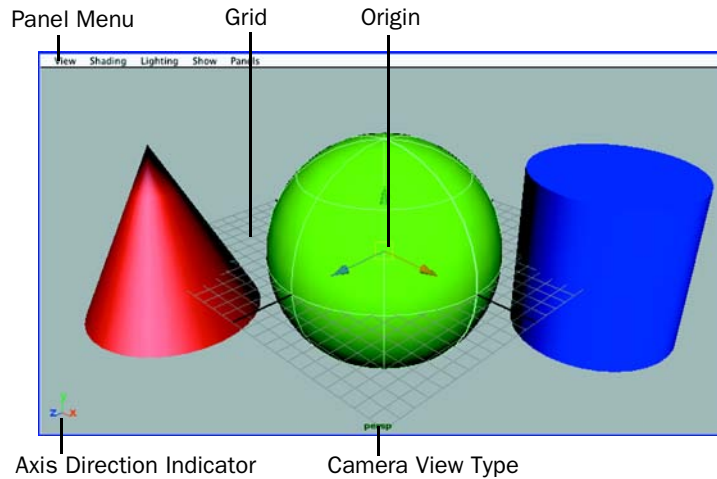

When you start Maya for the first time, the workspace displays by default in a perspective window, or *panel*. There are the other components of the default perspective view panel:

- The panel is labeled *persp* at the bottom to indicate that you are viewing the Maya scene from a perspective camera view.
- The panel has its own menu bar at the top left corner of the panel. These menus allow you to access tools and functions related to that specific panel.
- The grid is displayed with two heavy lines intersecting at the center of the Maya scene. This central location is called the *origin*. The origin is the center of Maya's 3D world, and with all object's directional values measured from this location.

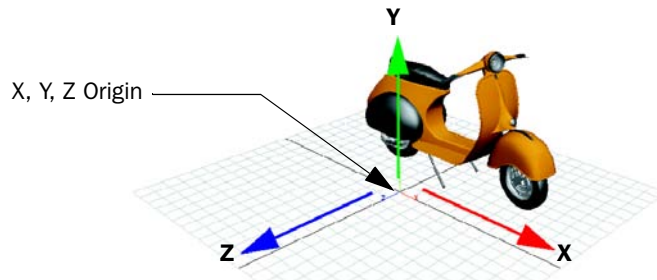

In Maya, like many other 3D applications, the three dimensions are labeled as the X, Y, and Z axes. The origin is located at X, Y, Z position of 0, 0, 0. The grid also lies along the X, Z plane. We refer to this as a *plane* because you might visualize an imaginary, flat, two-dimensional square laying along this 3D position.

Maya labels the X, Y, and Z axes with a color scheme: red for X, green for Y, and blue for Z. Many tools that you use in Maya use this color scheme to indicate that you are accessing a particular item that relates to X, Y, and Z in some way.

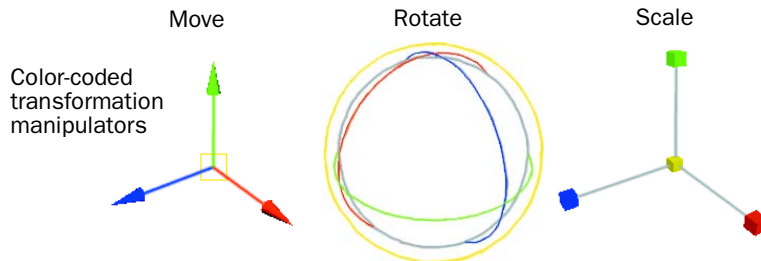

The axis indicator shows in which direction, X, Y, or Z, you are viewing the Maya scene. The axis indicator is color coded in the red, green, and blue color scheme and appears in the lower left corner of a view panel.

This is extremely useful if you are new to 3D, as many of the instructions in this manual and the Maya Help assume you know where you are viewing the scene in relation to the X, Y, Z axes.

2 | Maya Basics

Lesson 1 > The Maya interface

Main Menu bar

Tools and items are accessible from pull down menus located at the top of the user interface. In Maya, menus are grouped into *menu sets*. These menu sets are accessible from the Main Menu bar.

The Main Menu bar appears at the top of the Maya interface directly below the Maya title bar and displays the chosen menu set. Each menu set corresponds to a *module* within Maya: Animation, Modeling, Dynamics, and Rendering. Modules are a method for grouping related features and tools. Maya® Unlimited™ has additional menu sets (Maya® Cloth™ and Maya® Live™).

Menu Selector

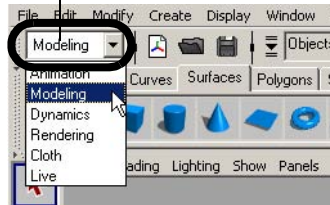

You switch between menu sets by choosing the appropriate module from the menu selector on the Status Line (located directly below the File and Edit menus). As you switch between menu sets, the right-hand portion of the menus change, but the left-hand portion remains the same; the left-hand menus are common menus to all menu sets. The left-hand menus contain File, Edit, Modify, Create, Display, and Window.

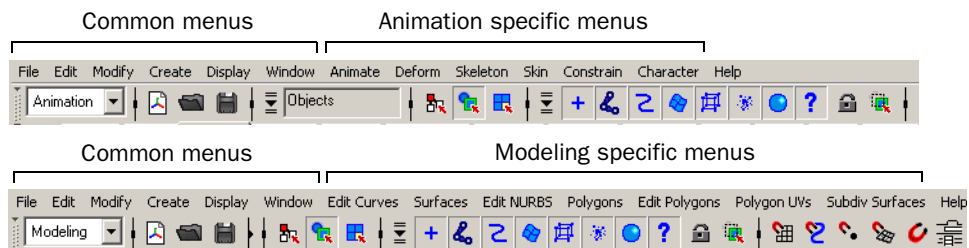

Getting Started with Maya

To select a specific menu set

- 1 On the Status line, select Animation from the drop-down menu.
The Main Menu changes to display the menu set that relates to the Animation module. In particular, menu titles such as Animate, Deform, Skeleton, Skin, and so on, appear.
- 2 Using the menu selector, choose Modeling from the drop-down menu.
The main menu changes to display the menu set for Modeling. Menu titles such as Edit Curves, Surfaces, Edit NURBS, and so on, appear.
For now, leave the menu set at Modeling. You will use this set in the next step.

To create a primitive 3D object from the Modeling menu set

- 1 From the Main Menu Bar, select Create > Polygon Primitives > Cube.
Maya creates a 3D cube primitive object and places it at the center (origin) of the Maya workspace.

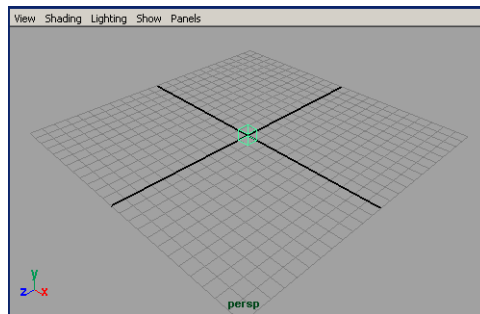

Status Line

The Status Line, located directly below the Main Menu bar, contains a variety of items, most of which are used while modeling or working with objects within Maya. Many of the Status Line items are represented by a graphical icon. The icons save space in the Maya interface and allow for quick access to tools used most often.

In this lesson, you learn about some of the Status Line areas.

2 | Maya Basics

Lesson 1 > The Maya interface

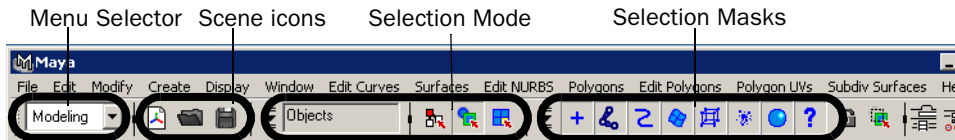

You've already learned the first item on the Status line: the Menu Selector used to select between menu sets.

The second group of circled icons relate to the scene and are used to create, open, and save your Maya scenes.

The third and fourth group of buttons are used to control how you can select objects and components of objects. You will learn more about selection of objects in later lessons.

The fifth group of icons are used to control the Snap Mode for objects and components. You will begin to use these tools in a later lesson in this chapter.

The last section comprise three buttons that are used to show or hide editors, including the Attribute Editor, Channel Box, Layer Editor, and Tool Settings. The default display shows the Channel Box and the Layer Editor. When you create an object, like the cube for example, information about that object displays in these editors. You will learn how to use these editors later in this chapter.



For better organization on the Status Line, all of the icon buttons are broken into groups that you can expand and collapse, as shown.

Collapse icon groups by clicking on vertical bars

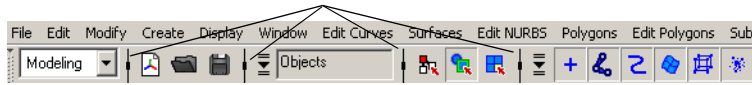

Expand icon groups by clicking on vertical arrow bars

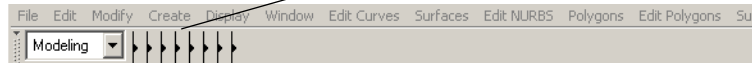

Shelf

The Shelf is located directly below the Status line. The Maya Shelf is useful for storing tools and items that you use frequently or have customized for your own use. You can keep the tools and items you use most frequently in a location that provides handy access. Maya has some of the Shelf items pre-configured for your use.

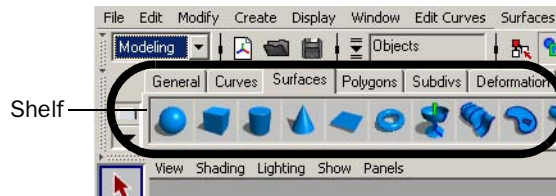

To create an object using a tool from the Shelf

- 1 From the Shelf, select the Surfaces tab in order to view the tools located on that shelf.

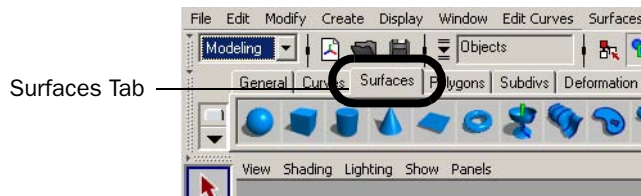

- 2 From the shelf, select the NURBS sphere icon located on the left end of the shelf by clicking on it.

2 | Maya Basics

Lesson 1 > The Maya interface

Maya creates a sphere primitive object and places it at the center of the Maya workspace in the same position as the cube.

Tip

You can determine if this is the correct tool prior to choosing it by first placing your mouse cursor over the icon, the name or description of it appears in a popup window directly over it.

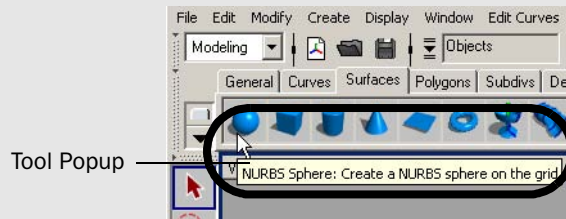

In your scene view the wireframe outline of the cube you created earlier in the lesson has changed color to navy blue, and the sphere is displayed in a bright green color. The sphere is now the *selected* object and the cube is no longer selected. In Maya, when the object displays like this, we refer to it as being *selected* or *active*.

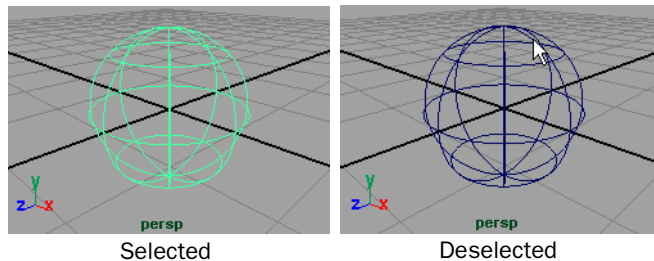

Selection of objects and components is a way of indicating to Maya that this particular item is to be affected by the tool or action you will subsequently choose. As you work with Maya, you will be selecting and deselecting items a lot. You will learn how to select and deselect objects later in this chapter.

Some numerical information appears in the *Channel Box* editor on the right hand side of the user interface. This information relates to X, Y, and Z, translation, rotation, and scaling for the active object. The X, Y, and Z Translate numerical values are currently set to 0. This indicates that the sphere's location is at the origin. The Channel Box is useful for viewing and editing this type of basic information. You will use the Channel Box later in this chapter.

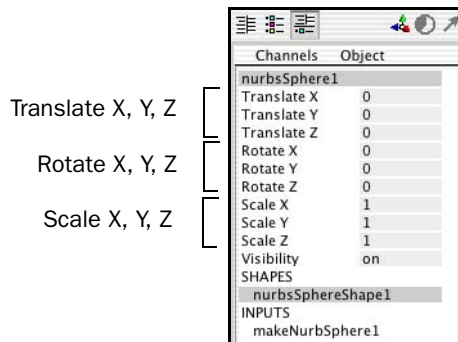

To hide or show the Channel Box

- 1 To hide the Channel Box, click the Show/Hide Channel Box icon from the right end of the Status line.

The Channel Box disappears, and the perspective scene view expands slightly. With the Channel Box hidden, you have more working area in your scene view.

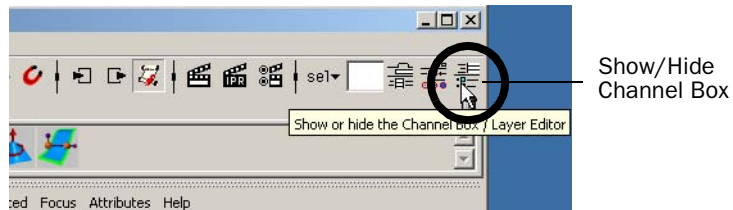

- 2 To show the Channel Box, click the Show/Hide Channel Box icon on the Status line. The Channel Box appears in the scene view.

2 | Maya Basics

Lesson 1 > Saving your work

Saving your work

Make it a habit to save your work often when working on your Maya projects. In that way, you can always open an earlier version of your work should you make a mistake.

Maya refers to everything you've created in your workspace as the *scene*. This includes any objects, lights, cameras and materials associated with your working session.

To save your Maya scene

- 1 Select File > Save Scene.

A file browser appears, listing the default directory where you can save your scene.

- 2 Type: `Lesson1` in the file name text box.

- 3 Click Save.

Maya saves your file to the scene directory within your Maya default project directory. Maya automatically saves the file with a `.mb` file extension. The `.mb` file extension indicates that the scene was saved as a Maya binary file: the default file type for a Maya scene.

Exiting Maya

Before you exit Maya, ensure you save any work that you want to retrieve and continue with at a later time.

To exit Maya

- 1 Select File > Exit from the main menu.

Maya does one of the two following actions:

- If you have saved your scene immediately preceding the Exit command, Maya exits.
- If you have not recently saved your scene, a message prompt appears on the screen asking if you want to save your changes. Click either Yes, No, or Cancel.

Beyond the lesson

In this lesson you began your orientation to Maya by learning:

- How to start Maya on your computer.
- The Maya workspace, and how it shows three dimensional space (X, Y, Z).
- How Maya color-codes items and tools related to X, Y, Z.
- The location of the main menus for the various modules within Maya.
- How to create a three-dimensional object from the Modeling menu.
- The location of the Status Line and how items are displayed as icons.
- About the Shelf how to create a three dimensional object from the Shelf.
- How to hide and show the Channel Box and that basic transformation, scaling, and rotational information for an object can viewed in the Channel Box.
- How to save your work.
- How to exit Maya.

As you proceed through Getting Started with Maya you should be familiar with the fundamental concepts and skills covered in this first chapter.

If you want to learn more about a particular tool or feature that has been presented in this lesson, refer to the Maya Help.

Lesson 2 Creating, manipulating, and viewing objects

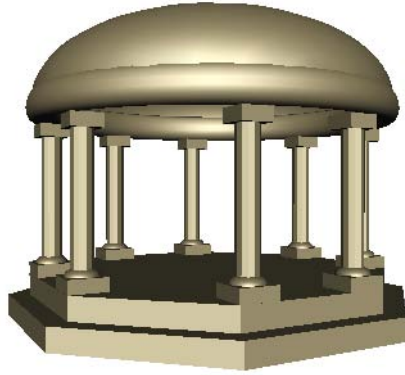

Using primitive objects to model 3D forms is a great place to continue learning about Maya. You can create many types of 3D objects using Maya and then move, scale, and rotate them to create more complex forms in your scene.

In this lesson, you begin to construct a classic temple using the primitive object creation tools in Maya. The project is not very complex and provides you with experience in using some of the important object manipulation and viewing tools.

As you continue to work with Maya, you'll learn how to visualize more complex forms using these basic objects. Maya has many advanced tools and options for modeling complex forms, as you will learn in later chapters.

In this lesson, you learn how to:

- Create 3D primitive objects.
- Select objects for manipulation and editing purposes.
- Move and rotate objects using your mouse.
- Move, rotate, and scale objects using numeric input.
- Duplicate objects.

- Change the viewing panels in Maya using a variety of methods so you can view your objects from different points of view.
- Undo actions when you need to undo a particular task or step.

Creating a new scene

You begin your temple project by creating a new empty scene.

To create a new scene

- 1** Start Maya (if it is not already running).
When Maya starts, it automatically creates a new scene.
If Maya was previously running, follow steps 2 and 3.
- 2** From the main menu, select File > New Scene.
Maya displays the following prompt.

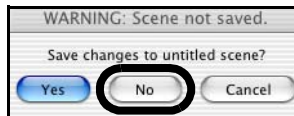

- 3** Click No.
Maya creates a new scene and delete everything that was in the previous scene.

Primitive objects

Maya provides many types of primitive types and shapes such cubes, spheres, cylinders, and planes.



2 | Maya Basics

Lesson 2 > Primitive objects

Primitive objects can be used as a starting point for a wide variety of shapes and forms. The most common workflow when using primitive objects is:

- Set the construction options for the primitive when you initially create it so that it appears in the Maya scene roughly in the size and shape that you require.
- Move, scale, and rotate the primitive object into its final position either by direct manipulation (the move, scale, and rotate tools), or by entering numeric values through an editor.
- Duplicate the primitive objects to create multiple copies of the original or create different variations from your original primitive object.

In this section, you construct the base for the temple using a polygonal cylinder primitive. The octagonal shape is created by modifying the creation options for the cylinder tool before you create the object. If you did not modify the cylinder options you would create a round cylinder.

To create a polygonal cylinder for the base

- 1 Select the Modeling menu set.

Note Unless otherwise indicated, the directions in this lesson for making menu selections assume you've already selected the Modeling menu set.

- 2 From the main menu, select Create > Polygon Primitives > Cylinder > .
An option window appears.
- 3 In the Polygon Cylinder Options window, select Edit > Reset settings and then set the following options:
 - Radius: 10
 - Height: 1
 - Subdivisions Around Axis: 8
 - Subdivisions Along Height: 1
 - Subdivisions on Caps: 1

- Axis: Y
- 4** In the Polygon Cylinder Options window, click Create.
- Maya creates a cylinder primitive object that is octagonal in shape and positioned at the center of the Maya workspace. This cylinder is 20 units wide by one unit high, and has eight faceted sides.

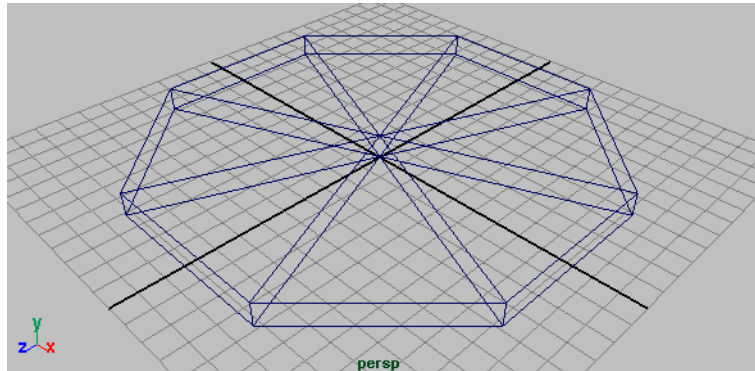

Note You were instructed to reset the option settings as a precaution in case they had been set differently. This is a good habit to practice when working with tool options to avoid getting a result that was different from what you expected.

The Toolbox: Layout shortcuts

The Toolbox is located on the left hand side of the Maya user interface. It contains icons that open tools for transforming your objects within Maya (selection, move, rotate, scale) as well as layout shortcuts for changing the views and panel layouts.

The Quick Layout buttons shortcuts allow you to select a different panel or switch to another layout.

2 | Maya Basics

Lesson 2 > The Toolbox: Layout shortcuts

You need to finish positioning the cylinder. To do this you need to see the object from a side view to make sure it is sitting exactly on the ground plane.

To change the panel layout to view the base from a side view

- 1 From the Toolbox, click the Four View layout shortcut.

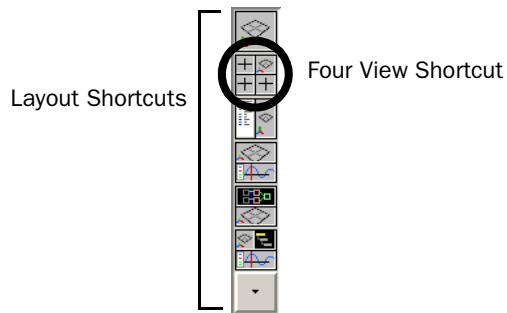

The workspace changes to a four-view layout. The perspective view is located in the top right corner and the other views show the object from the top, front and side. The layout shortcuts have other options that you will learn later in this tutorial.

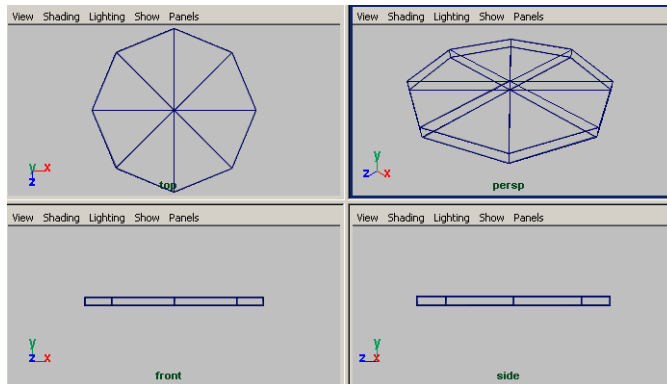

It is now possible to see the base from the side view, but it would be easier to determine the position of the base if the side view were enlarged to a full view.

- 2 To enlarge the side view, position the mouse cursor in the side view, and tap the spacebar of your keyboard.

The workspace changes to a single view layout with the side view in an enlarged view. It is easier to view the position of the base from this side view. Notice that the base lies slightly above and below the ground plane (X, Z).

Tip You can position your mouse cursor in any modeling view and click the spacebar once to toggle the view. If the view is a full panel view, it will change to a four panel view and vice versa.

The Toolbox: Transformation tools

You need to move the base slightly upwards in the Y direction so it is positioned on the X, Z plane. To do this you use the Move transformation tool located in the Toolbox.

The upper half of the Toolbox contains the tools for transforming objects (selection, move, rotate, scale) within Maya. When you move your mouse cursor over any transformation tool icon you see the name of the tool appear next to the mouse cursor.

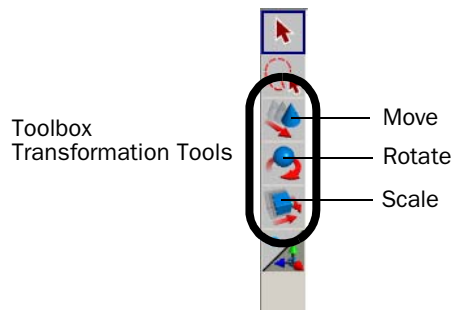

2 | Maya Basics

Lesson 2 > The Toolbox: Transformation tools

The tool's name also appears in the Help Line at the bottom of the Maya window. The Help Line has an additional purpose: it displays summary instructions as you use tools that require several steps.

Move Tool: Use manipulator to move object(s). Use edit mode to change pivot (INSERT). Ctrl+LMB to move perpendicular.

Selection and de-selection of objects

Before you can transform an object, you must ensure it is selected. You can select objects by clicking them directly, or by dragging a rectangular bounding box around some portion of the object to indicate what you want selected. To deselect an object, you simply click somewhere off of the selected object.

Click on wireframe object to select

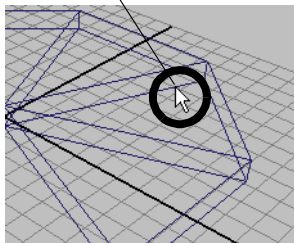

Bounding box selection

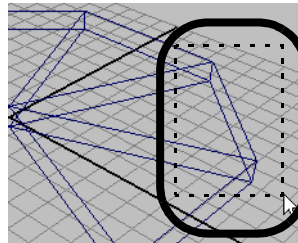

To select the base primitive object in the scene view

Do one of the following:

- With your left mouse button, click the object's wireframe outline in the scene view.
- With your left mouse button, drag a bounding box around one corner or edge of the object's wireframe.

The object is selected when its wireframe outline color displays in a bright green color. If it is not selected, its display color is navy blue.

To use the Move Tool to adjust the position of the base

- 1 Select the Move Tool from the Toolbox.

A move manipulator icon appears over the primitive cylinder in the scene view.

The Move Tool Manipulator has handles that point in the direction of the three fundamental axis directions of 3D space: X, Y, Z. The handles are colored red, green, and blue based on their function related to the X, Y, Z axes and control the direction of the movement along an axis.

When you click a specific handle, it indicates that the move is constrained to that particular axis direction.

- 2** In the side view, drag the green Y manipulator handle to move the primitive cylinder upwards in the Y direction. Move it upwards enough so that the bottom of the base cylinder is aligned with the X axis (the thick dark line of the grid)

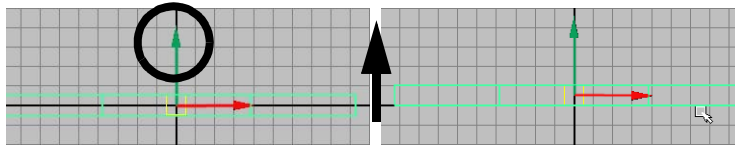

The base cylinder now needs to be rotated slightly so the front of the base is parallel to a grid line. Since each facet of the octagon represents 45 degrees of a circle, you need to rotate the object approximately half of that amount or 22.5 degrees.

To use the Rotate Tool to adjust the position of the base

- 1** Display all four views by positioning the mouse cursor in the view and tapping the spacebar of your keyboard.
The four view panel appears.
- 2** Position the mouse cursor in the top view and tap the spacebar once.
The top view appears in the workspace.
- 3** With the base cylinder selected, choose the Rotate tool from the Toolbox.
A rotate manipulator icon appears over the primitive cylinder in the scene view.

2 | Maya Basics

Lesson 2 > The Toolbox: Transformation tools

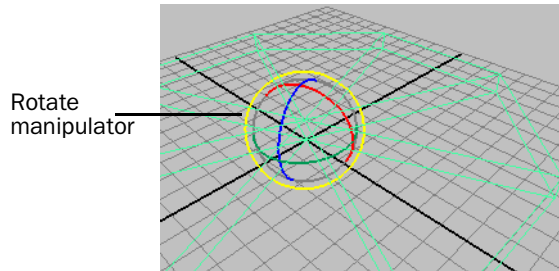

The Rotate Tool manipulator consists of three rings (handles), plus a virtual sphere enclosed by the rings. The colors of the handles correspond to the X, Y, and Z axes. The handles are colored red, green, and blue based on their function related to the X, Y, Z axes and control the direction of the rotation around an axis.

- 4 In the top view, drag the green Y manipulator ring to rotate the primitive cylinder so that one of the facets of the base cylinder is aligned with the grid as shown in the image below.

You are rotating the cylinder around its Y axis.

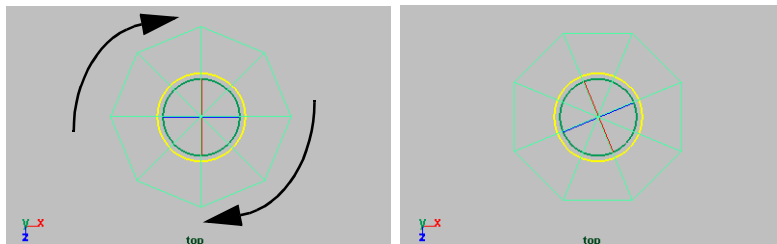

You may be asking yourself the question “How do I know if I’ve rotated the base exactly 22.5 degrees?” You can check the accuracy of the rotation by viewing the Channel Box. Rotate Y should be close to 22.5 degrees.

Tip

You can undo and redo the last action you performed. Undo reverses the last action you performed on a selected object. It also reverses any action you performed from the Edit Menu.

To undo an action select, Edit > Undo. Maya allows you to perform multiple undos.

The Channel Box

The Channel Box is an editing panel that provides you access to an object's transformation information and much more. It provides information on three distinct areas for any type of object: The transform node, shape node, and input node.

Nodes are where information about object types are kept track of within Maya. Nodes are comprised of *attributes*. *Attributes* refer to information related to what the node is designed to accomplish. In this case, information about the primitive cylinder's Y axis rotation is referred to as the *Rotate Y attribute*. You will learn more about nodes later in this tutorial.

When you moved and rotated the cylinder primitive using the Move Tool, you were doing this by your own visual judgement. This will usually be sufficient for many of your creative applications.

If you need to control the attribute of an object with more accuracy you can do this by entering the precise values into the appropriate attribute field of the Channel Box.

To move and rotate the base using the Channel Box

- 1 With the base cylinder selected, view the Transformation attributes in the Channel Box. Specifically, view the values for Translate Y, and Rotate Y.

2 | Maya Basics

Lesson 2 > Duplicating objects

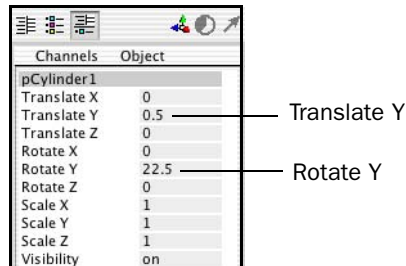

- 2 In the Channel Box, adjust the attribute values so they match the above image by clicking in the field and entering the correct numerical values. This accurately positions the base in your Maya scene. Maya named the cylinder primitive when it was first created. Rename the cylinder to something more meaningful to your project.

To rename the cylinder primitive using the Channel Box

- 1 In the Channel Box, click in the field with the name *pCylinder1*.
- 2 Rename the primitive object by typing the new name: `templeBase` and then pressing Enter.

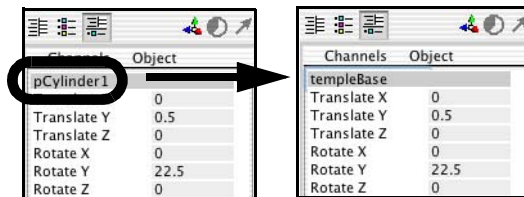

Duplicating objects

Duplicating an existing object is a useful way to make an exact copy of it without having to start over. When you duplicate an item the copy takes on the characteristics of the original. Using the Duplicate Tool you can additionally apply transformations to the copy (move, rotate, scale).

Return to a four view layout to view what you've accomplished to this point.

To change the panel layout to a four view layout

- From the Toolbox, click the Four View layout shortcut.

The workspace changes to a four view layout. It is easier to view the work from this four view layout.

The base for the temple is constructed of two levels and appears stepped. You duplicate and scale the templeBase object using the duplicate tool.

To duplicate the temple base

- 1** Display all four views by positioning the mouse cursor in the view and tapping the spacebar. Then click in the perspective view to display the base in this view.
- 2** With templeBase selected, choose Edit > Duplicate > from the main menu. The Duplicate Options window appears.
- 3** In the Duplicate Options window, select Edit > Reset settings and then set the following options:
 - Translate: 0 1.0 0
 - Rotate: 0 0 0
 - Scale: 0.9 1.0 0.9
 - Geometry Type: Copy
 - Group under: Parent
- 4** In the Duplicate Options window, click Duplicate.

Maya creates a duplicate of the templeBase object that is scaled to 0.9 of the original in the X, Z axes, and is one unit above *templeBase*. As a result of the scale operation, the base for the temple now appears stepped.

Maya keeps track of the name of the duplicated object based on the name of original and renames the duplicated object *templeBase1*.

2 | Maya Basics

Lesson 2 > Creating a project

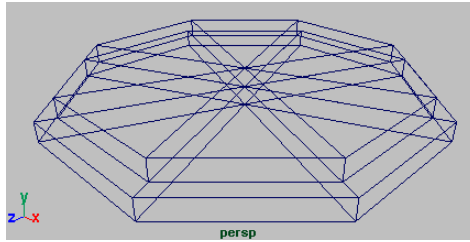

Creating a project

A project is a file directory that stores and organizes all of the files (scenes, images, materials, textures, etc.) related to a particular scene. In Maya, you create and work with a variety of file types and formats. The project directory allows you to keep these different file types in their unique subdirectory locations within the project directory.

To create a project

- 1** From the main menu, select File > Project > New.
The New Project window opens.
- 2** Enter the name `MayaBasics` for the new project in the Name text box, and then click Use Defaults.
Clicking Use Defaults will assign a default directory and name to the various subdirectories associated with the project.
- 3** Click Accept to create the new project with subdirectories.
When you next save your work for this lesson it will automatically default to the `MayaBasics` project directory.

Save your work

In the last lesson we recommended that you save your work at regular intervals. An example of this is when you have just completed a major task such as constructing the base for the temple. With this strategy, if you ever make a mistake, you can always open the previously saved version of your work and begin from there.

To save your Maya scene

- 1 Select File > Save Scene.

A file browser appears showing the default project scene directory where you can save your scene.

- 2 Type `Lesson2Base` in the file name text box.
- 3 Click Save.

Beyond the lesson

In this lesson you continued with the fundamental tools and skills to successfully learn:

- An overall workflow for constructing forms using primitive objects.
- Where the primitive object tools are located in the main menu.
- How to create a primitive object as well as reset and edit its creation options.
- How to change between a single view and four view panel layout using layout shortcuts and by tapping the spacebar of your keyboard.
- How to select objects by clicking them with your mouse.
- How to move and rotate objects using the transformation tools in the Toolbox.
- That tool manipulators can constrain a transformation to the X, Y, or Z axes.
- How to edit an object's transformation node attributes (move, rotate, scale) accurately using the Channel Box.
- How to rename objects using the Channel Box.
- How to duplicate objects and apply transformations while doing so.
- How to create a project directory.

We suggest you additionally practice the following tasks on your own:

- Creating other primitive object types, with various options so that you can understand the variations that are possible.

2 | Maya Basics

Lesson 2 > Beyond the lesson

- Practice moving, rotating, and scaling objects, and changing between the various scene views (single perspective, four view, single side, single top etc.)

Lesson 3 Viewing the Maya 3D scene

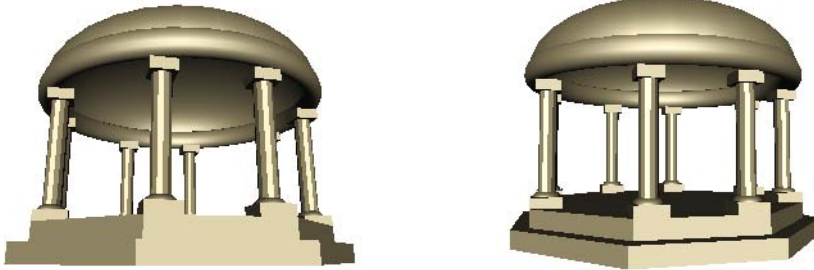

In the previous lesson you learned how to view your 3D scene by changing between single and four view layouts. It is important for you to learn how to change your views in a more interactive manner so that you can: view your objects close up or far away, select objects more accurately, or view objects from different angles in your perspective view.

In this lesson you learn how to:

- Understand the difference between moving objects in the scene and moving the point of view on the scene.
- Use the dolly, track, and tumble camera tools to change the view of your scene in both the orthographic and perspective views.
- Rotate objects using the transformation tools in the Toolbox.
- Select objects using a variety of techniques.
- Group objects together so they can be transformed as a unit.
- Display objects in both wireframe and shaded modes.
- Use additional primitive objects and options.

2 | Maya Basics

Lesson 3 > Camera tools

Camera tools

In the lessons so far, when you looked at an object from the top, front, or side views you have been viewing the scene through an *orthographic view*. Orthographic views appear two-dimensional because the object is displayed using parallel projections of only two axes at a time. (Scooter images courtesy of *The Art of Maya*)

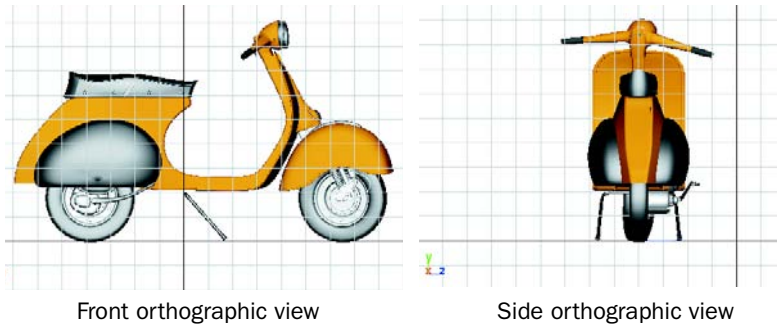

When you view the scene through the perspective view, you are viewing the scene in a three-dimensional manner. The perspective view simulates what your scene would look like from a camera's point of view.

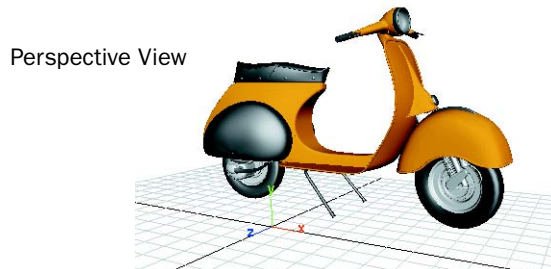

In Maya, you view the scene through a set of virtual cameras. These cameras are either orthographic or perspective in nature. You can adjust how these cameras view the scene using the Camera Tools.

The three primary methods for manipulating the camera view are *dolly*, *tumble*, and *track*.

Dolly Tool

The Dolly Tool gets its name from filmmaking where a camera, mounted on a wheeled tripod, is moved towards or away from the scene. In Maya, dollying allows you to view the items in your scene either close up or from further back.

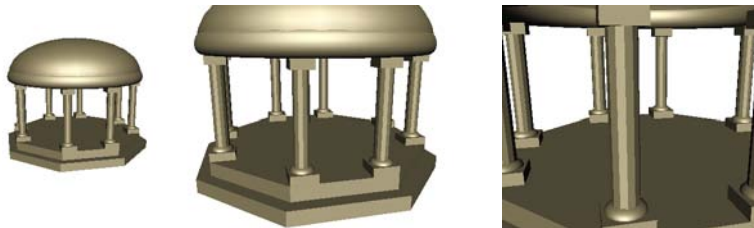

To dolly the perspective view

- 1** Enlarge the scene view to a single perspective view.
- 2** Do one of the following:
 - (Windows) Press the Alt key and drag the mouse to the right while holding down the right button on your mouse.
 - (Mac OS X) Press the Option key and drag the mouse to the right while holding down the right button on your mouse.
 - (Linux) Press the Alt key and drag the mouse to the right while holding down the left and middle buttons on your mouse.

2 | Maya Basics

Lesson 3 > Camera tools

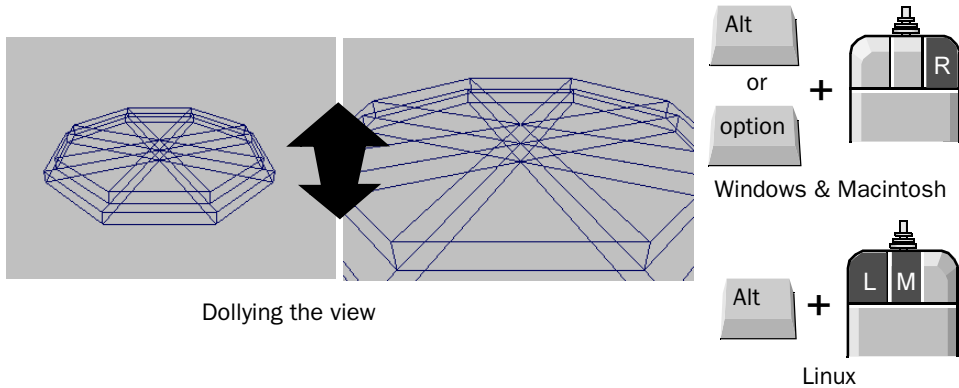

- 3** To dolly the camera outwards from the subject in the scene you can perform the same key and mouse combinations as described above but drag the mouse to the left.

Dolly works in both the perspective and orthographic views.

Tip If you make an error when adjusting your camera view of the scene, you can reset the camera to its default home setting. To reset the camera view for a particular orthographic or perspective view:
From the panel menu, select View > Default Home.

Tumble Tool

The Tumble Tool allows you to tumble or rotate the camera's view around a particular center of interest to achieve either a higher or lower vantage point, or a different side angle.

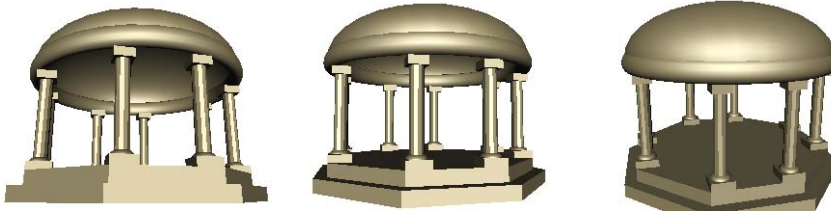

To tumble the perspective view

- Press the Alt key (Windows & Linux) or the Option key (Mac OS X) and drag the mouse either left or right, or up or down, while holding down the left button on your mouse.

Tumbling the view revolves the camera around the center of the scene view, in whichever direction you drag (left, right, up or down). The Tumble Tool does not work in the orthographic views.

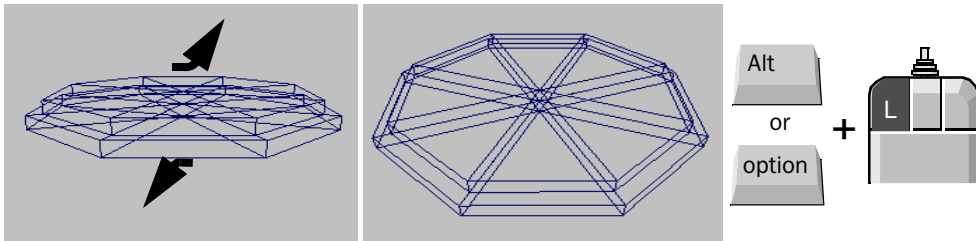

Tumbling the persp view

Track Tool

The Track Tool allows you to move the camera up, down, or sideways in relation to the scene.

2 | Maya Basics

Lesson 3 > Workflow overview



To track the perspective view

- Press the Alt key (Windows & Linux) or the Option key (Mac OS X) and drag the mouse in any direction, while holding down the middle button on your mouse.

The Tracking Tool works for both orthographic and perspective views.

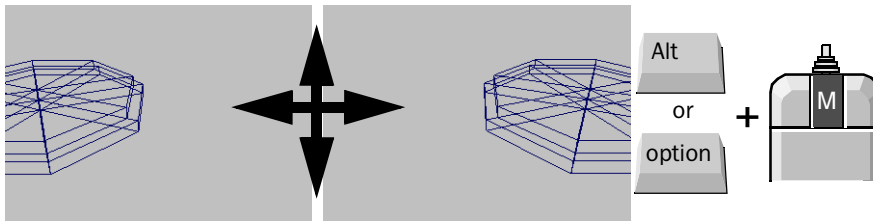

Tracking the view

Note Even though the objects appear to move across the screen when operating any of the camera tools, it is the viewing camera that is actually moved in relation to the scene, not the objects.

Workflow overview

The columns are made up of multiple primitives that are moved, scaled, and rotated into position. Once the first column is created, with each component named and accurately positioned, you will group and duplicate it to create others.

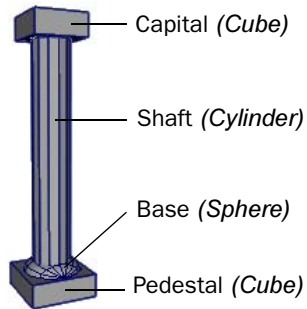

To create a polygonal cube for the pedestal

- 1 From the Main Menu, select Create > Polygon Primitives > Cube > .
- 2 In the Polygon Cube Options window, select Edit > Reset settings and then set the following options:
 - Width: 1.75
 - Height: 0.6
 - Depth: 1.75

Leave the other options at their default settings.

- 3 In the Polygon Cube Options window, click Create.

Maya creates a cube primitive and positions it at the origin.

- 4 In the side view, move the cube upwards (Y axis) so it rests on the top surface of the temple base.

You can do this using the Move Tool or with the Channel Box. If you use the Channel Box, enter a Translate Y value of 2.3.

You may find it useful to dolly or tumble the scene view to obtain a better viewpoint.

2 | Maya Basics

Lesson 3 > Workflow overview

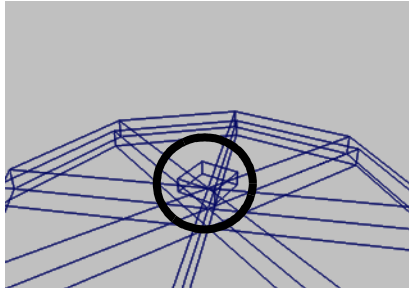

- 5 In the Channel Box, rename the cube *columnPedestal*.

To create a polygonal cylinder for the shaft

- 1 From the main menu, select Create > Polygon Primitives > Cylinder > .
- 2 In the Polygon Cylinder Options window, select Edit > Reset settings and then set the following options:
 - Radius: 0.5
 - Height: 6
 - Subdivisions Around Axis: 12Leave the other options at their default settings
- 3 In the Polygon Cylinder Options window, click Create.
Maya creates the cylinder primitive at the origin.
- 4 In side view, move the cylinder upwards (Y axis) so it rests on the top surface of *columnPedestal*.
You can do this using the Move Tool or with the Channel Box. If you use the Channel Box, enter a Translate Y value of 5.6.

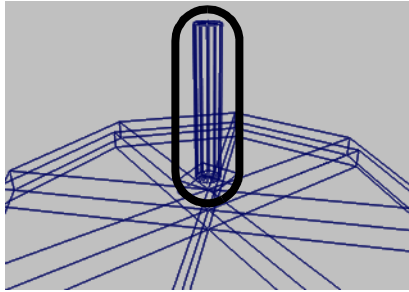

- 5** In the Channel Box, rename the cube *columnShaft*.

The capital for the column rests on top of the column and is very similar to the pedestal. You duplicate the pedestal and position the duplicate at the top of the column.

To duplicate the pedestal to create the capital

- 1** With only *columnPedestal* selected, select Edit > Duplicate >  from the main menu.

The Duplicate Options window appears.

- 2** In the Duplicate Options window, select Edit > Reset settings and then set the following options:
 - Translate: 0 6.6 0
 - Scale: 0.8 1.0 0.8

Leave the other options at their default settings.

- 3** In the Duplicate Options window, click Duplicate.

Maya creates a duplicate of the *columnPedestal* object and moves and scales it based on the options you set.

Note If you positioned the geometry for the column using the Transform Tools and your mouse, the Y translate values may be incorrect for your particular model. You may want to continue positioning the objects by visual reference using your mouse.

2 | Maya Basics

Lesson 3 > Workflow overview

Using the duplicate options is an alternate method for positioning and scaling duplicated objects when you can anticipate its final location.

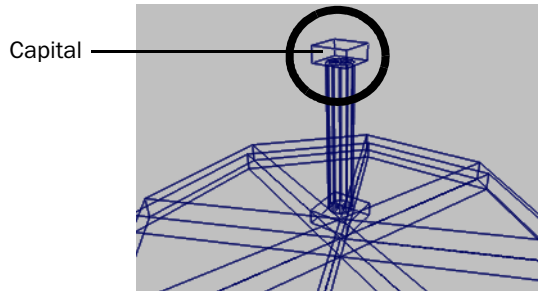

- 4 In the Channel Box, rename the duplicated cube *columnCapital*.

The base for the column rests on top of the pedestal. You will create the base using one half of a NURBS sphere primitive and then move and rotate it into position. You will do this by modifying the creation options for the sphere primitive.

To create a NURBS sphere for the column base

- 1 Select Create > NURBS Primitives > Sphere > .
- 2 In the NURBS Sphere Options window, select Edit > Reset settings and then set the following options:
 - Start Sweep Angle: 0
 - End Sweep Angle: 180
 - Radius: 0.75
 - Number of Sections: 8
 - Number of Spans: 4

Leave the other options at their default settings.

- 3 In the NURBS Sphere Options window, click Create. Maya creates a half-sphere primitive at the origin.

To rotate and position the sphere on the pedestal

The sphere needs to be rotated 90 degrees and then positioned on top of the pedestal.

- 1** In side view, rotate the sphere so that the dome part is pointing up. This is accomplished by either of the following methods:
 - Rotating the sphere about the X axis using the Rotate Tool's manipulator handle.
 - Using the Channel Box to change the Rotate X value to -90.
- 2** Move the sphere so it rests on the top surface of columnPedestal (Translate Y = 2.6, if you have been inputting values into the Channel Box).
- 3** Using the Scale Tool, scale the sphere along its Z axis (blue manipulator handle) so that the sphere becomes slightly squashed in appearance.

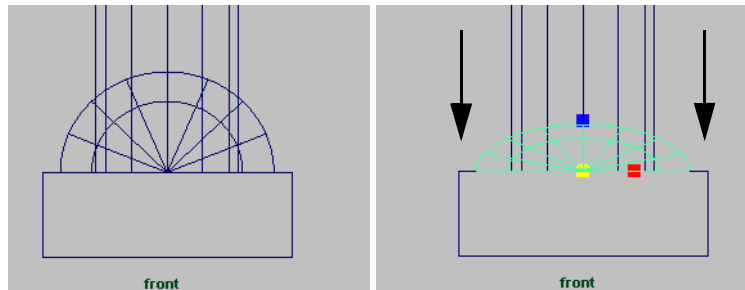

When you scale an object non-uniformly along one of its axes, you are scaling it *non-proportionally*.

2 | Maya Basics

Lesson 3 > Viewing objects in shaded mode

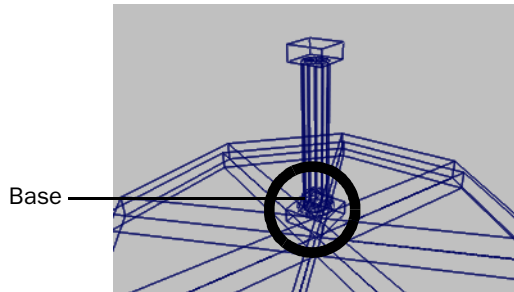

- 4 In the Channel Box, rename the sphere *columnBase*.

Viewing objects in shaded mode

Up to this point, you have been viewing your objects in the default wireframe mode. In wireframe mode, objects appear transparent except for the simple wire outline that indicates their position and general shape. Maya provides several options for displaying objects in a shaded manner.

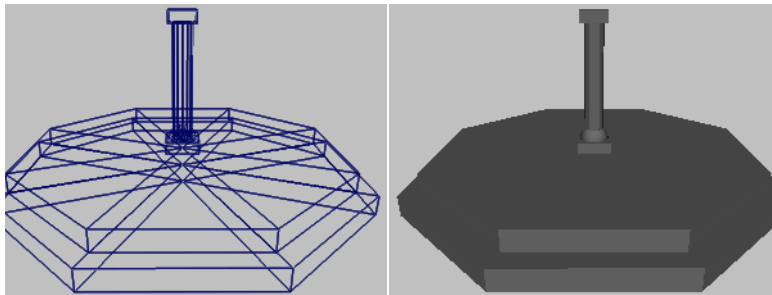

Change the display of your scene so that the objects display as shaded objects.

To display the objects in smooth shaded mode

- 1 Enlarge your perspective view, and dolly and tumble the scene so you can easily view what you've completed so far.
- 2 From the panel menu, select Shading > Smooth Shade All.

The objects in your scene display in an opaque dark gray color. You can work with objects in either shaded or unshaded mode for the balance of this lesson.

Grouping objects

When you need to move, scale or rotate multiple objects as one unit it is easier if they have been grouped together so that they transform as one unit.

Many of primitive objects in Maya are grouped objects. For example, the NURBS cube primitive is comprised of 6 flat squares or *planes* that have been grouped together as one unit. When the plane objects are grouped together they create a *hierarchy*.

A hierarchy is a collection of nodes or objects that are connected together to form a unit for some purpose. Hierarchies are useful for describing how the objects within them share similar characteristics or *attributes*; move, scale, rotate for example.

To group the objects for the column

- 1** Select the four objects that comprise the column simultaneously by doing one of the following:
 - With your left mouse button, shift-click each object in turn until the four objects are selected in the scene view.
 - With your left mouse button, drag one large bounding box around the column objects in an orthographic view.

It is important that you do not select any of the templeBase objects as part of your selection. If you accidentally select any of the base objects, deselect them.

- 2** From the main menu, select Edit > Group > .
- 3** In the Group Options window, select Edit > Reset settings and then set the following options:
 - Group Under: ParentLeave the other options at their default settings
- 4** In the Group Options window, click Group.

2 | Maya Basics

Lesson 3 > The Hypergraph

Maya groups the objects together in a *hierarchy*. You will learn more about hierarchies in the steps that follow.

The Hypergraph

The Hypergraph is a window that shows how the nodes and their connections are organized in your scene. You view object hierarchies and dependencies in the Hypergraph. Use the Hypergraph to view what happens when you group an object.

To view the Hypergraph

- 1 From the view menu, select Panels > Layouts > Two Panes Stacked.
The scene view splits into two viewing panels - each has their own separate view menu. You will set these to view the scene in the upper view and the Hypergraph in the other.
- 2 From the lower pane menu, select Panels > Panel > Hypergraph.
The Hypergraph panel will display below the scene view panel.
- 3 At the top of the Hypergraph panel, select the Scene Hierarchy icon.

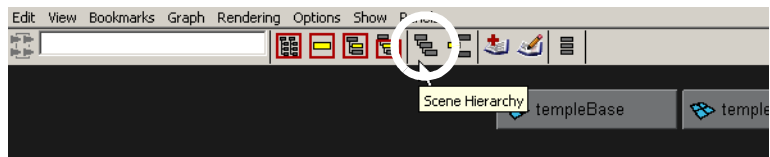

- 4 In the Hypergraph panel, select View > Frame All.
The Hypergraph displays the hierarchy for all of the objects in the scene. This approach to viewing the entities in the scene provides a very graphical approach to viewing all of the various nodes in your scene.



In the Hypergraph, each node is represented as a rectangle labelled with an icon that denotes the type of information it represents (for example, surface, shading, and so on). Each node has a unique name assigned to it when it is first created. When you rename your objects, you are actually renaming the node associated with that object.

Some nodes display with a line connecting them. This denotes that they are in a hierarchy and have a dependency structure based on how they were originally grouped.

For the temple's column objects, the hierarchy displays each of the named objects under a node labelled *group1*. *Group1* is the *parent node* for this hierarchy of objects.

In Maya, when the *parent node* (sometimes referred to as the root node) is moved, rotated, or scaled in any way, the child nodes (sometimes referred to as the leaf nodes) underneath are also affected.

When you select objects at the top level of a hierarchy and move them, the objects within the hierarchy or group follow.

Note This system of nodes, attributes, and hierarchies may initially appear somewhat complex, but it is one of the most powerful features of Maya. The node based architecture provides flexibility and power to create complex models, shaders, and animations.

To rename the parent node in the Hypergraph

- 1** In the Hypergraph, click on the *group1* node so it becomes active.
In the scene view, all of the objects in the column group become selected as a result of selecting the group at the top (parent) level of the hierarchy.
- 2** In the Hypergraph, right-click the top node representing *group1* and select Rename from the pop-up menu.
A small text box appears in the node.
- 3** Enter `Column` as the new name.

Now that the column is grouped, you need to position it at one corner of the temple base.

2 | Maya Basics

Lesson 3 > The Hypergraph

To position the column on the temple base

- 1 Change the display of objects to wireframe mode by tapping the 4 key on your keyboard.

This is a keyboard shortcut. Instead of selecting the item from the menu you can use a single key to implement the command.

Tip Many of the tools and features in Maya can be accessed using keyboard shortcuts. In Maya, these shortcuts are called *Hotkeys*. Some Hotkeys are displayed directly beside the menu item, others are listed in the Hotkey editor. For a complete listing of available hotkeys, go to Window > Settings/Preferences > Hotkeys.

- 2 In the Hypergraph, select the *Column* at the top node so that *Column* becomes active in the scene view.
- 3 In the scene view, use the Move Tool to position *Column* at the front corner of the temple base as shown below.

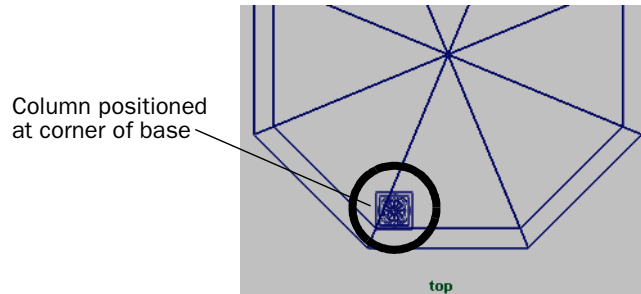

With your first column in position, you can now create a copy of the column and position it on the adjacent corner of the base.

To create a duplicate copy of the column

- 1 With *Column* still selected in the Hypergraph, select Edit > Duplicate > from the main menu.

The Duplicate Options window appears.

- 2** In the Duplicate Options window, select Edit > Reset settings and then set the following options:

- Number of Copies: 1

Leave the other options at their default settings.

- 3** In the Duplicate Options window, click Duplicate.

The Hypergraph view updates to show an additional column object in the scene. The copy also takes on the prefix name of the original group and is now labelled *Column1*.

In the scene view it appears that nothing was actually duplicated. When an object is duplicated without any transformations the copy is positioned in the same position as the original. The two objects are on top of each other.

You need to move the column into position on the adjacent corner of the temple base.

To move the duplicate column into position on the base

- 1** In the Hypergraph, ensure *Column1* is selected by clicking on its top node so it becomes selected in the scene view.
- 2** In the scene view, use the Move Tool to position *Column1* on the adjacent corner of the temple base as shown below.

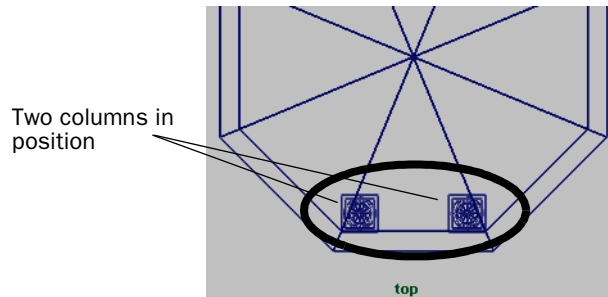

- 3** From the Toolbox, click the Four View layout shortcut.
The workspace changes to a four view layout and the Hypergraph is no longer displayed.

2 | Maya Basics

Lesson 3 > Selection modes and masks

Selection modes and masks

It isn't always efficient to have the Hypergraph window open when you want to select an object at a particular level within its hierarchy. Maya allows you to select items in different selection modes depending upon your specific needs.

There are three main types of selection modes: Hierarchy, Object and Component. You use these modes in order to *mask* or limit the selection of other objects in order to select only the types of items you want. When you use a selection mask you are filtering out or masking items you don't want to be chosen as part of the selection.

The icons for the three modes appear on the Status Line.

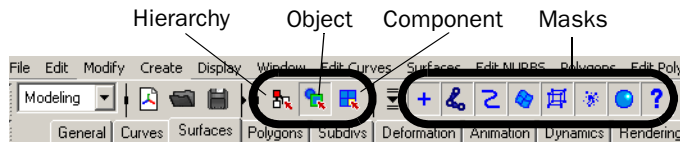

When you first start Maya, the default selection mode is set to Objects. This is useful for much of your selection work with Maya, with a few exceptions. When you want to select items that have been grouped, set the selection mode to Hierarchy.

Tip If you set the selection mask, it will remain that way until you change it again. If an item won't select for you in Maya, you should check the selection mask setting to see if it is set correctly.

To use the Hierarchy and Combinations selection mask

- 1 On the Status Line, choose the Select by Hierarchy and Combinations icon. The Selection Mask icons update to display the three selection choices.
- 2 On the Status Line, choose the Select by hierarchy icon.

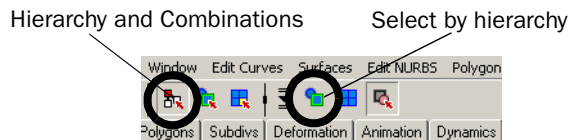

Select by hierarchy ensures that when you select items they are selected at their parent or root node.

- 3** In the scene view, shift-click *Column* and *Column1* so they are selected simultaneously. (Do not be concerned that they highlight in different colors.)

Pivot points

A pivot point is a specific position in 3D space that is used as a reference for the transformations of objects. All objects (curves, surfaces, groups) have pivot points.

When you group objects in Maya, a new node called a *parent node* is created for the group of objects. The pivot point for the group's parent node is placed at the origin (0, 0, 0). This is useful if you later want to duplicate and rotate the objects radially (that is, in a circular fashion around the pivot).

To group the two columns

- 1** Ensure *Column* and *Column1* are selected.
- 2** From the main menu, select Edit > Group > .
- 3** In the Group Options window, select Edit > Reset settings. Set the following options:
 - Group Under: Parent
- 4** In the Group Options window, click Group.

Maya groups the objects together in a hierarchy and the pivot point is positioned at the origin. (When the pivot point is relocated to the origin the Move Tool manipulator for the selected group appears at the origin)

With the two columns grouped, you then duplicate the columns with a rotation option, the groups will duplicate and rotate around the pivot point at the origin (0, 0, 0).

To duplicate and rotate the group

- 1** With column group selected, select Edit > Duplicate >  from the main menu.

2 | Maya Basics

Lesson 3 > Save your work

- 2 In the Duplicate Options window, select Edit > Reset settings and then set the following options:
 - Rotate: 0 90 0
 - Number of Copies: 3
- 3 In the Duplicate Options window, click Duplicate.
The columns are duplicated and rotated by 90 degrees with each copy.

Each column group is duplicated and copied 90 degrees

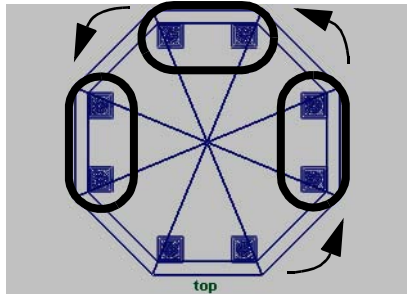

Save your work

Your temple is taking shape! Save your work before proceeding to the next lesson.

To save your Maya scene

- 1 To save your Maya scene, select File > Save Scene As.
- 2 Type `Lesson3Columns` in the file browser area reserved for file names.
- 3 Click Save.

Beyond the lesson

In this lesson, you explored additional tools and skills within Maya as you continued with the construction of the classic temple. In this lesson you learned how to:

- Use your mouse to change the view of your scene using the dolly, track, and tumble camera tools in both the orthographic and perspective views.

Getting Started with Maya

- Rotate objects using the transformation tools in the Toolbox and the Channel Box.
- Group objects so they can be transformed as a unit.
- Display objects in both wire frame and shaded modes.
- Access the Hypergraph to view nodes and hierarchies. You are also learning that many tasks in Maya can be completed or approached using multiple techniques.
- Rename nodes within the Hypergraph.
- Select objects in your scene using the Hypergraph.
- Use the group pivot point to your advantage when duplicating objects.

Before proceeding with the next lesson you may want to review the material presented in this lesson so you are familiar with the concepts and skills associated with them. Some suggested tasks you can try on your own include:

- Practice using the view camera tools (dolly, track, and tumble) so you can navigate within the scene views efficiently.
- Practice moving and rotating objects, and changing between the various scene views (single perspective, four view, single side, single top, and so on).
- View objects in the Hypergraph so you can understand their relationships and hierarchy.

2 | Maya Basics

Lesson 4 > Template display

Lesson 4 Components and attributes

Working with components is an important part of the workflow when working in Maya. Components describe objects at a more detailed level. As you edit the components of your classic temple, you will learn more about what is possible in Maya.

In this lesson you learn how to:

- Template objects in the scene.
- Understand the difference between objects and components.
- Edit objects at their component level.
- Assign surface material attributes
- Access the Attribute editor

Template display

When your scene becomes complex, templating the display of some of the objects in your scene allows you to more easily select only the objects you want. When you template the display of an object, its wireframe changes to a gray color. The object(s) can still be seen, but not easily selected. This helps to prevent you from selecting or modifying it accidentally. You can change the display of objects to a template and use them as a modeling reference (the way a grid is used).

You need to change the display of the base and columns to template mode so that you can more easily work on the temple roof.

To template the base and columns

- 1** In the side view, with the Selection Mask set to Hierarchy, select all the objects in your scene.
- 2** From the main menu, select Display > Object Display > Template.
The selected objects become templated.

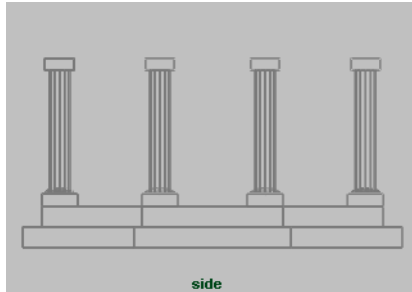

For your classic temple, you need to create the entablature using a torus primitive. An entablature is a structure that lies horizontally upon the columns of a temple and supports the roof.

To create and position a torus primitive for the entablature

- 1** From the main menu, select Create > NURBS Primitives > Torus > .
- 2** In the NURBS Torus Options window, select Edit > Reset settings and then set the following options:
 - Radius: 8.5
 - Minor Radius: 0.5
 - Number of Sections: 24
- 3** In the NURBS Torus option window, click Create.
- 4** In the Channel Box, rename the torus primitive *Entablature*.
- 5** Move the entablature vertically in the scene so it rests on top of the columns (Translate Y = 9.7).

2 | Maya Basics

Lesson 4 > Components

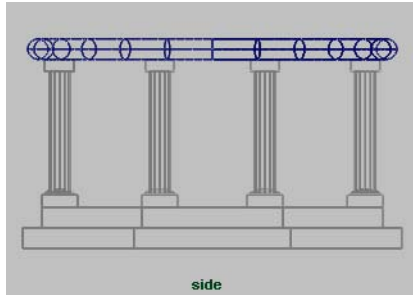

Components

All objects in Maya have a transform and a shape node. Geometric shapes, like the primitives in this tutorial, have smaller parts called *components*. A few examples of components in Maya are control vertices, faces, and hulls. Components allow you to work with objects at a finer level and allow you to edit them in creative ways.

In order to change the shape of the entablature beyond the basic scale transformations, you need to modify its component information.

To select components of the entablature

- 1** In the side view, dolly in for a closer view of *Entablature*.
- 2** Set the Selection Mode to Components.
- 3** Right-click the wireframe of Entablature and select Control Vertex from the pop-up menu.

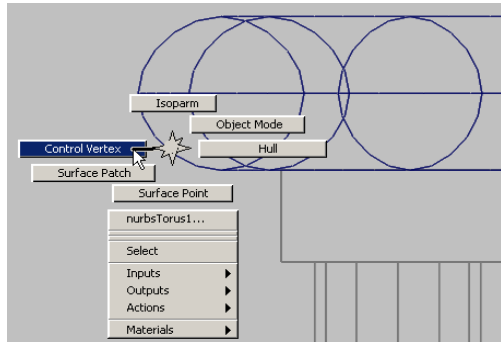

The menu that pops up is a *marking menu* for quickly selecting operations relevant to the object where you right-click the mouse. In this case, the choices pertain to the display of the entablature's components.

A set of small blue squares appear on Entablature called control vertices. Control Vertices (CVs) describe the shape of an object based on their position in space. If you move any combination of these vertices, you change the shape of the object.

- 4** Drag a selection box around the top row of vertices so they become selected.
- 5** Using the Move Tool, move the vertices up vertically as shown below to change the shape of *Entablature*.

Control Vertices
moved upwards

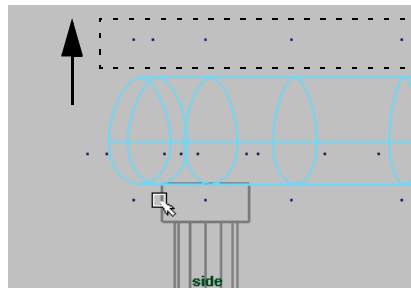

- 6** To cancel the display of the CVs, right-click the wireframe of Entablature once again and select Object Mode from the pop-up menu.

2 | Maya Basics

Lesson 4 > Components

The roof for the temple rests on top of the entablature. The roof for the temple is created using one half of a sphere primitive.

To create a roof for the temple

- 1 Select Create > NURBS Primitives > Sphere > .
- 2 In the NURBS Sphere Options window, select Edit > Reset settings and then set the following options:
 - Start Sweep Angle: 0
 - End Sweep Angle: 180
 - Radius: 8.75
 - Number of Sections: 8
 - Number of Spans: 4

In the NURBS Sphere Options window, click Create.

- 3 Rename the half-sphere *templeRoof*.

The roof needs to be rotated 90 degrees and positioned on top of the entablature.

To rotate and position the roof on the entablature

- 1 In side view, rotate the roof so that the dome part is pointing up.
- 2 Move the roof so it is positioned close to the top edge of *Entablature*.
- 3 Scale the roof along its Z axis (blue manipulator handle) so that the sphere becomes slightly squashed in appearance.

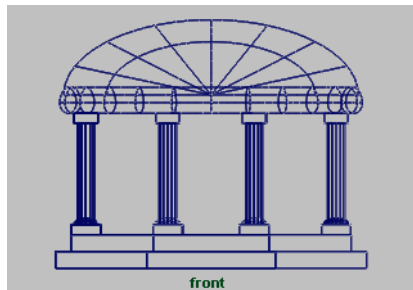

Now that the roof is complete, you can untemplate the templated objects.

To untemplate objects

- 1 On the Status Line, choose the Select by Hierarchy and Combinations button.
- 2 On the Status Line, choose the Select by hierarchy: template button.

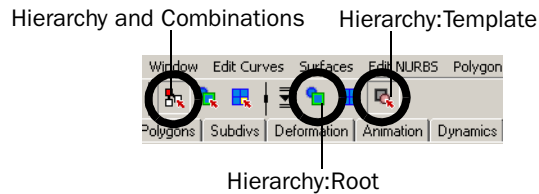

Select by hierarchy: template ensures that only templated objects will be affected by a selection.

- 3 In the scene view, drag a selection box around all the objects in the scene so that the templated objects are selected simultaneously.
- 4 From the main menu, select Display > Object Display > Untemplate.
- 5 On the Status Line, choose the Select by hierarchy: root button.

The Attribute Editor

The Attribute Editor provides information about the various nodes and attributes for the objects and materials in your scene. Like the Channel Box, you can view and edit the basic transform information and many other keyable attributes. However, the Attribute Editor provides a more detailed display of all attributes for a selected object.

To view object attributes using the Attribute Editor

- 1 In the scene view, select templeRoof so it becomes the selected object.
- 2 To view the Attribute Editor, click the Show/Hide icon on the Status Line.

2 | Maya Basics

Lesson 4 > The Attribute Editor

Show/Hide Attribute Editor



The Attribute Editor displays the attributes for templeRoof. The various attributes for the templeRoof object appear under various tabs. Each tab represents a node.

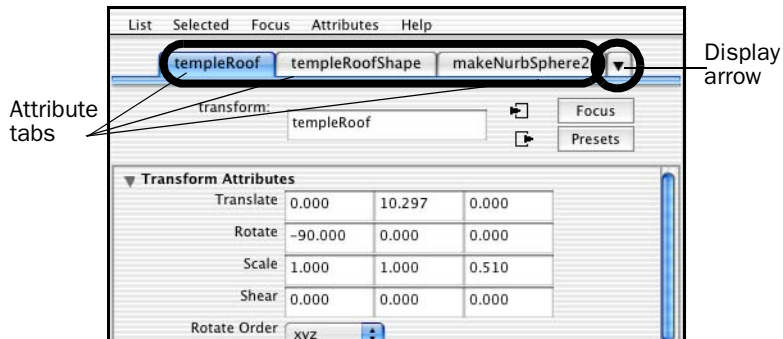

- 3 Click on the templeRoof tab to see its attributes.

This tab is known as the transform node, because the most important attributes on this tab control templeRoof's transformation. Every visible object in Maya has a transform node, including cameras and lights.

- 4 Click on the templeRoofShape tab to see its attributes.

This tab is called the shape node because the attributes establish the object's geometric shape or physical properties when the object is first created. Most objects have shape nodes, some do not, such as the group for the column objects. The shape node also includes other types of attributes, such as object display attributes.

- 5 Click on the makeNurbSphere tab to see its attributes.

This is an input node that includes attributes related to the object's construction history. The attributes of an input node are passed to another node subsequent in the construction history for the object—in this case, to the templeRoofShape node.

- 6** The last two nodes are initialShadingGroup and lambert1. If you can't see them, click the display arrow.

The initialShadingGroup and lambert1 nodes are default nodes that relate to the default shading material for an object. Maya uses them to establish the initial color of objects and other settings related to shading. If you create your own shading materials for the temple, as you will in the following steps, these nodes are replaced by the new shading nodes you create.

Surface materials

The color, shininess, and reflectivity attributes of an object are controlled by its surface material (sometimes referred to as a shader, or shading material). Material attributes relate to how the object simulates a natural reaction to light in Maya's 3D computer world.

Maya assigns a default shading material to all objects when they are first created. In this section, you learn how to assign a new material to your objects.

To assign a new material to the temple objects

- 1** Right-click the wireframe of Entablature and select Object Mode from the pop-up menu.

2 | Maya Basics

Lesson 4 > Surface materials

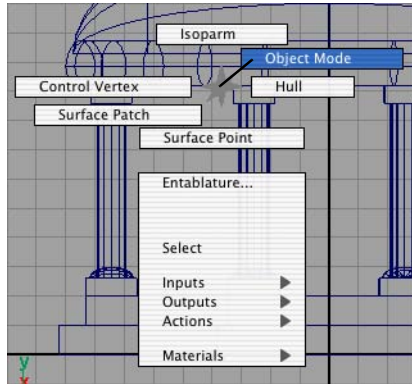

This changes the selection mask back to objects so you can select objects in the scene. It is a shortcut to access this feature.

- 2 Drag a selection box around all the objects in your scene to select them.

Tip If objects won't select in the Maya scene, check that your selection mask is set correctly on the Status Line.

- 3 From the Status Line, select the Rendering menu set using the menu selector.
The main menu changes to display the menu set for Rendering.
- 4 From the main menu, select Lighting/Shading > Assign New Material > Blinn.
A Blinn shading material is assigned to all the objects in the scene and the Attribute Editor updates. Blinn shading materials (named after the inventor of this shading algorithm) provide for high-quality specular highlights on surfaces.
- 5 In the Attribute Editor, rename the blinn1 shading material to *templeShader*.

With a shading material assigned to all the objects, you need to edit the color attributes of the *templeShader* material.

To edit the shading material's attributes

- 1 In the Attribute Editor, click in the gray box to the right of the word Color.



The Color Chooser appears.

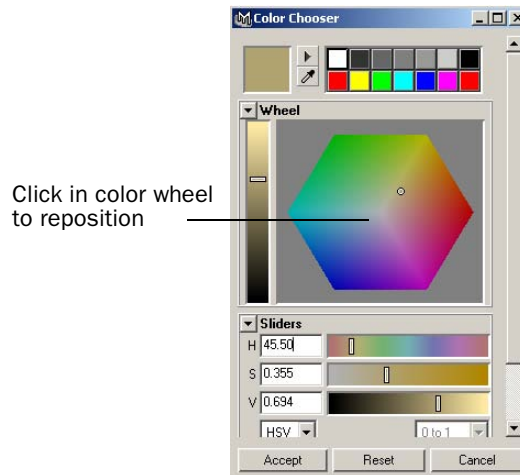

- 2** Click inside the color wheel (hexagon) and drag the pointer to achieve a sand color.

The exact color is unimportant for this lesson. As you adjust the color wheel indicator, the temple objects become the same color you select in the Chooser.

- 3** Click Accept to close the chooser.

You will learn more about Maya's shading and texturing capabilities in future lessons.

2 | Maya Basics

Lesson 4 > Save your work



- 4 In the Attribute Editor menu, choose the Selected menu item, and select `templeBase` from the list.

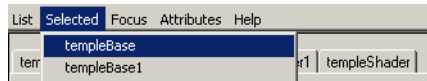

The attributes for `templeBase` display in the Attribute Editor.

- 5 Click on the `templeShader` node tab to see its attributes.

If you can't see this tab, click the display arrow to the right of the tabs.

These are the same attributes you edited when you assigned the `templeShader` shader to all the objects in the scene. When you first create an object, you see two default nodes for shading, `initialShadingGroup` and `lambert1`. When you assign a shading material, the two default nodes are replaced by the attribute node for the assigned shading material.

You will encounter transform, shape, input, and shading nodes throughout your work with Maya. There are other types of nodes that you'll learn about as you continue learning about Maya.

- 6 Close the Attribute Editor using the Show/Hide icon.

Save your work

You have completed this lesson. Save your work before proceeding.

To save your Maya scene

- 1 Select File > Save Scene As.

Getting Started with Maya

- 2 Type `Lesson4Final` in the file browser area reserved for file names, and then click **Save**.

Beyond the lesson

In this lesson, you completed the construction of the classic temple and learned how to:

- Display objects in template mode.
- Select objects at their component level using selection masks and the right mouse button.
- Assign and edit shading materials for your objects in the scene.
- Access the Attribute editor and view the various node types for objects.

As you proceed through *Getting Started with Maya*, we assume you are familiar with the fundamental concepts and skills covered in this first chapter.

Before proceeding to the next chapter you may want to review the material presented in this lesson so you are familiar with the concepts and skills associated with them. Some suggested tasks you may want to do on your own:

- Practice construction of additional forms using primitive shapes by creating additional details for your temple scene (stairs, roof details, etc.).
- Learn more about the tools and options that have been presented in this lesson, by referring to the Maya Help. To view the Maya Help, select **Help > Maya Help**.

2 | Maya Basics

Lesson 4 > Beyond the lesson

3 Polygonal Modeling

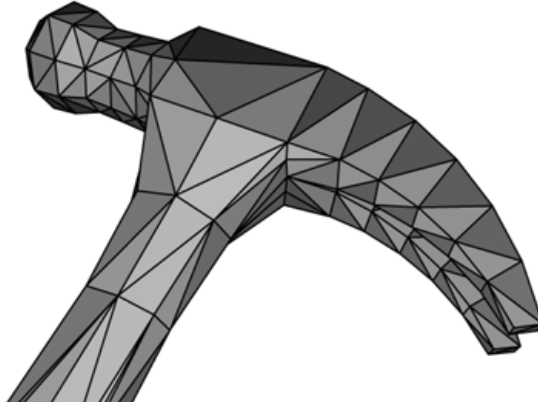

In Maya, *modeling* refers to the process of creating virtual 3D surfaces for the characters and objects in the Maya scene. Surfaces play an important role in the overall Maya workflow as they are the items upon which shading and texture attributes will be assigned. It is these attributes that assist in the creation of a convincing 3D image. The more accurate you are when modeling your forms in terms of size, shape, detail, and proportion, the more convincing your final scene will become.

There are three modeling surface types in Maya:

- Polygons
- NURBS
- Subdivision surfaces.

Each surface type has particular characteristics and benefits, and requires specific modeling techniques. Maya groups the surface modeling tools in a menu set specific to modeling.

3 | Polygonal Modeling

> Preparing for the lesson

Polygon surfaces are a surface type comprised of flat surfaces called *faces*. You can create a single polygonal face or a network of polygonal faces called a *poly mesh*. A poly mesh is comprised of many faceted three-or-more flat sided polygon faces. When a poly mesh is rendered, it is shaded smoothly so that the facets are not as apparent in the final image.

Polygonal surfaces can be used to create virtually any type of surface shape and are particularly useful when simple forms are required. Polygonal surfaces have a wide range of applications and are the preferred surface type for interactive games and web development applications. Polygonal surfaces are described with the smallest amount of data, and therefore, can be rendered more quickly, delivering increased speed and interactive performance to the end user.

Preparing for the lesson

To ensure the lesson works as described, do these steps before beginning:

- 1** Select File > New Scene to create a new scene.
- 2** Make sure the Construction History icon (below the menu bar) is on: . (If it is turned off, it has a large X across it.)
- 3** Select the Modeling menu set. Unless otherwise noted, the directions in this chapter for making menu selections assume you've already selected the Modeling menu set.
- 4** Make sure Display > UI Elements > Help Line is turned on. You will use the Help Line while modeling.

Lesson 1 Modeling a polygonal surface

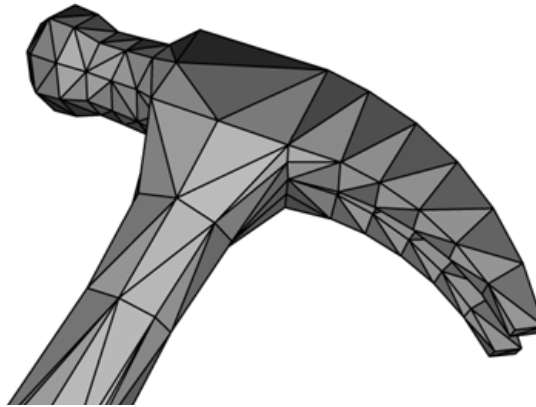

In this lesson, you model a simple hammer, starting from a cube primitive, using polygonal surface modeling techniques.

In this lesson you learn how to:

- Differentiate the basic components of polygonal surfaces.
- Use primitive objects as the basis for more complex polygonal models.
- Select the faces, edges, and vertices of polygonal meshes using your right mouse button.
- Extrude faces from an existing poly model to add detail.
- Move and rotate extruded polygonal meshes using the polygonal transformation manipulator.
- Split vertices and subdivide polygonal faces.
- Smooth polygons to make the model appear less faceted.
- Use the grid magnet feature.

3 | Polygonal Modeling

Lesson 1 > Creating a foundation shape from a primitive

Creating a foundation shape from a primitive

You begin the lesson by creating and scaling a cube into the rough shape of a hammer handle. You'll extrude a face of the handle to create a small box shape that you will use as the foundation for the head of the hammer.

To create a foundation shape

- 1** Select Create > Polygon Primitives > Cube > . In the options window, select Edit > Reset Settings and click the Create button.
- 2** With the pointer in the perspective view, press 5 (for Shading > Smooth Shade All).
- 3** Scale the cube into the general shape of a hammer handle. You'll enhance the shape later.

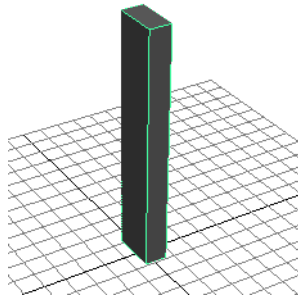

- 4** Move the cube so that its bottom lies on the grid (see illustration).
- 5** Right-click the cube and select Face from the marking menu.
Maya displays small squares at the centers of the faces. To select a face, you select the small square.
- 6** Select the face center at the top of the cube. Whenever you select a face, tumble the view in several directions to check that you've selected only the desired face.
- 7** Select Edit Polygons > Extrude Face.

3 | Polygonal Modeling

Lesson 1 > Creating a foundation shape from a primitive

Maya creates a new face in the same position as the previously selected one. The extrusion manipulator works like a combined Move, Rotate, and Scale Tool, but it modifies the new face rather than the whole object.

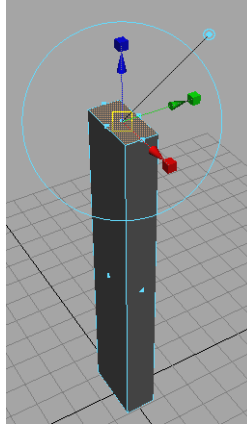

- 8 Drag the blue arrow up a little to extrude the face (see the following figure). The blue arrow turns yellow when selected. The resulting extension to the surface will become the middle section of the hammerhead between the claw end and the pounding end.

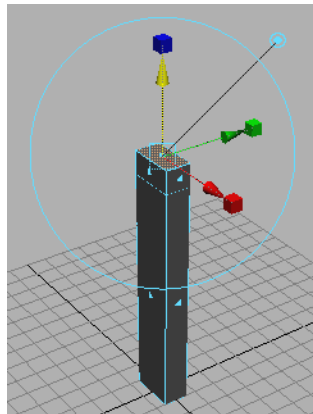

3 | Polygonal Modeling

Lesson 1 > Splitting polygons

- 9 Examine the parts of this manipulator, as shown in the following illustration. It is called the Show Manipulator Tool and appears for various operations throughout Maya.

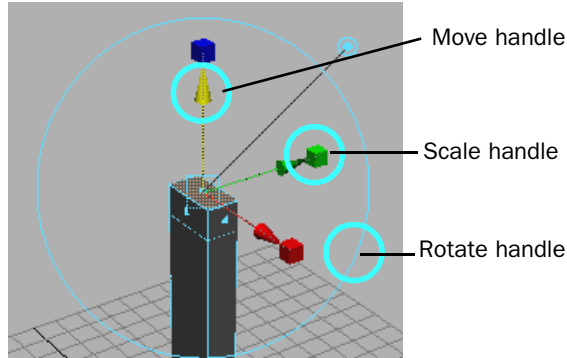

If you cancel the selection of the face, the manipulator disappears from the face. To display the manipulator again, select the face, select **Modify > Transformation Tools > Show Manipulator Tool**, then click the `polyExtrudeFace#` in the Channel Box.

Splitting polygons

Now you'll split one of the faces of the extruded shape into two parts. From these two parts, you'll create the claw end of the hammerhead.

To split polygons and manipulate the foundation shape

- 1 Select **Edit Polygons > Split Polygon Tool**.
- 2 Click one of the top, narrow edges as shown.

3 | Polygonal Modeling

Lesson 1 > Splitting polygons

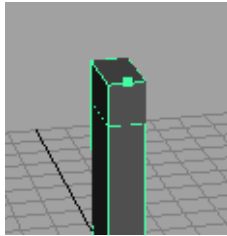

- 3 Middle-drag the point roughly to the edge's midpoint. If you are a perfectionist, examine the Help Line as you drag the point. When you see Percentage: 50%, the point is at the midpoint.
- 4 Click the bottom edge of the face and similarly drag the pointer to its midpoint. Press Enter (Windows and Linux) or Return (Mac OS X) to divide the face into two.

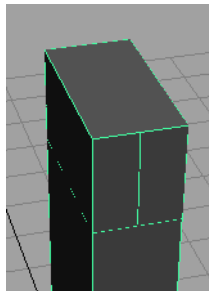

A single face split
into 2 faces

- 5 Right-click the cube and select Vertex from the marking menu.
- 6 Select the vertices at the top and bottom of the edge that divides the two faces. (If the vertices are hard to see, press 4 to select wireframe display mode.) Examine the object from several camera views to make sure you haven't accidentally selected extra vertices.

3 | Polygonal Modeling

Lesson 1 > Splitting polygons

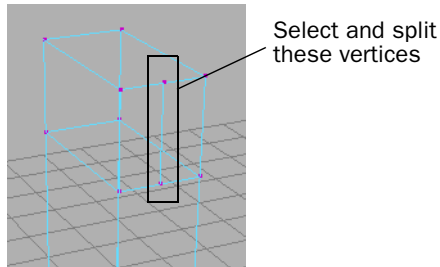

- 7** Select Edit Polygons > Split Vertex. The reason for splitting the vertices is explained later.
- 8** Shift-select the two split faces. (To display the face centers, right-click the cube and select Face from the marking menu.)
- 9** Select Edit Polygons > Extrude Face > . In the options window, open the Other Values section and enter 6 for Divisions, then click the Extrude Face button. You may need to scroll the option window to access the Divisions option.

A manipulator appears on one of the faces. Because two faces were selected when you selected Extrude Face, the manipulator controls the extrusion of both faces.

- 10** Drag the blue arrow outward to extrude the faces to a length appropriate for a hammer claw.

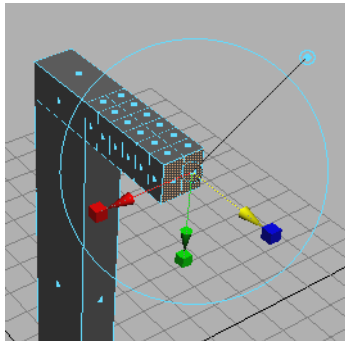

3 | Polygonal Modeling

Lesson 1 > Splitting polygons

When you extrude the faces, the length of the extruded surface will have six subdivisions rather than the default single subdivision. With the extra subdivisions, it will be easier to modify the extrusion into a claw shape in a later step.

- 11** Drag the red scale manipulator (the small cube) inward to narrow the blades, then drag the green scale manipulator up to flatten the blades at their tips. (See the next figure.)

This creates the preliminary shape of the hammer's claw.

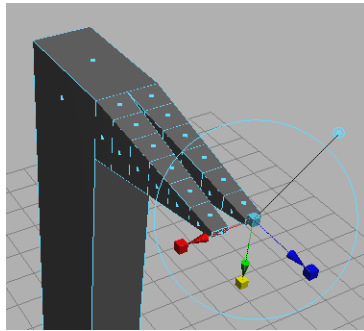

In a prior step, you split the vertices at the top and bottom of the edge that divided the two faces. This created two additional, overlapping vertices at each split vertex (a total of six vertices). The extra vertices were necessary to create a gap between the blades. Without the extra vertices, the two blades would be a solid single blade.

If you had extruded each face individually to create the two blades, you would not have needed to split the vertices to create the gap. However, it would have been harder to make the two blades exactly the same length, width, depth, and so on.

When you extrude two or more faces at the same time, the manipulators influence both identically. Symmetry is ensured.

3 | Polygonal Modeling

Lesson 1 > Using the poly extrude manipulator

Using the poly extrude manipulator

Now you'll enhance the curvature of the claw's blades and split the blades apart more. You will use the same extrude manipulator. If the manipulator is not displayed because you mistakenly cancelled the selection of the faces, select the extruded faces of the claw, select **Modify > Transformation Tools > Show Manipulator Tool**, and click `polyExtrudeFace2` in the Channel Box.

To modify the claw's shape using the manipulator

- 1 Click the large circle surrounding the manipulator to display the rotate manipulators. Drag the red circular manipulator down a bit to rotate the extrusion (see the following figure).

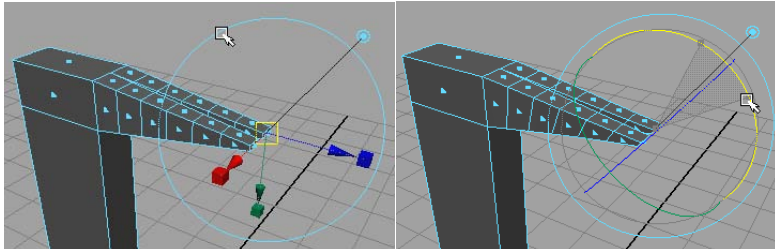

Rotating the angle of extrusion will help you to shape the claws downward in the next few steps.

- 2 Drag down the green and blue arrows a short distance to begin shaping the claw downward.

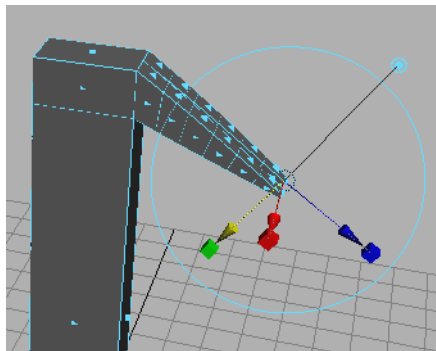

3 | Polygonal Modeling

Lesson 1 > Using the poly extrude manipulator

- 3 Right-click any part of the surface and select Vertex from the marking menu. Each subdivision of the claw has a group of vertices that separate it from the adjacent subdivision (see the following figure). Move each of these groups down or up a small distance to make the claw arch downward. (Drag one group of the vertices at a time.) You can shift-drag to constrain the movement of the vertices to a straight line.

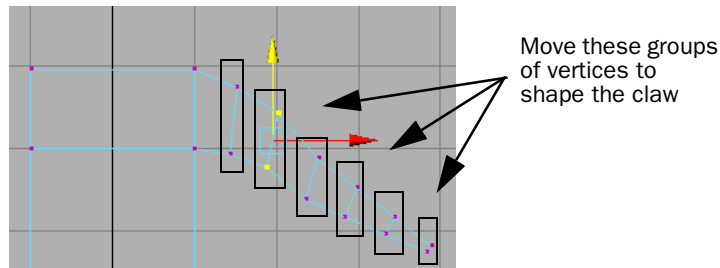

Two views of a completed example follow:

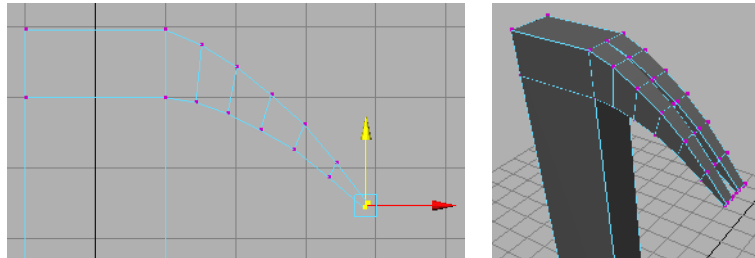

In the next steps, you'll extrude a face to create the pounding end of the hammerhead.

To extrude the pounding head for the hammer

- 1 Select the back face of the polygonal hammerhead.
- 2 Select Edit Polygons > Extrude Face > . In the options window, set Divisions to 1 and click the Extrude Face button. Move the face outward a short distance.

3 | Polygonal Modeling

Lesson 1 > Using the poly extrude manipulator

Also scale the extrusion inward along all three axes. To do this, click any of the scale manipulators to display a general scale manipulator at the center of the manipulator axes. Drag the center manipulator left to shrink the overall scale. This tapers the middle section of the pounding end of the head.

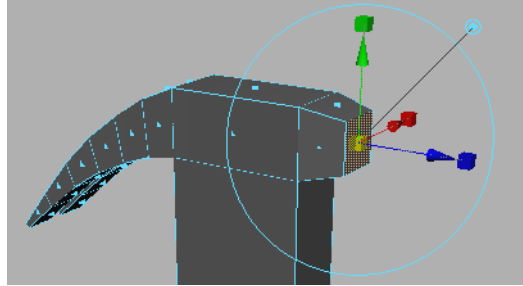

- 3 Select Edit Polygons > Extrude Face again and move the face outward again. Scale the extrusion outward along all three axes.

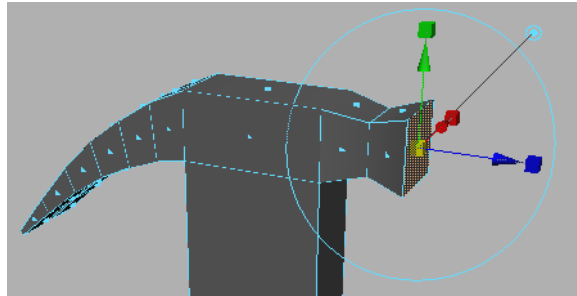

- 4 Select Edit Polygons > Extrude Face one more time and move the face outward. Leave the scale the same as the last extrusion.

3 | Polygonal Modeling

Lesson 1 > Using the poly extrude manipulator

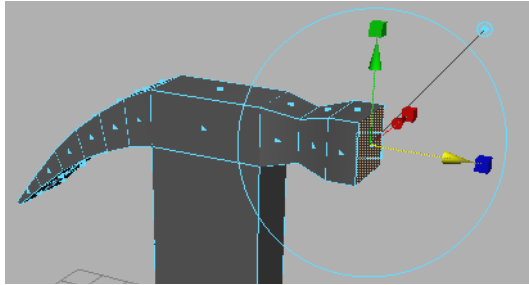

To create a depression at the top of the head

Now you'll extrude the top of the hammerhead inward and down to create a pit or depression. Hammers often have such pits where the handle is fastened to the head.

- 1 Select the face at the center top of the hammerhead.

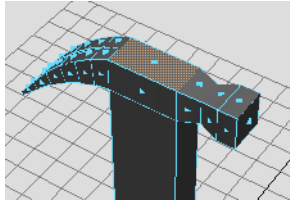

- 2 Select Edit Polygons > Extrude Face and scale the extrusion inward along all three axes.

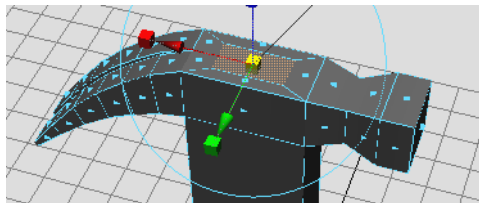

- 3 Select Edit Polygons > Extrude Face and drag the extrusion down. This creates the pit in the hammerhead.

3 | Polygonal Modeling

Lesson 1 > Subdividing polygon faces

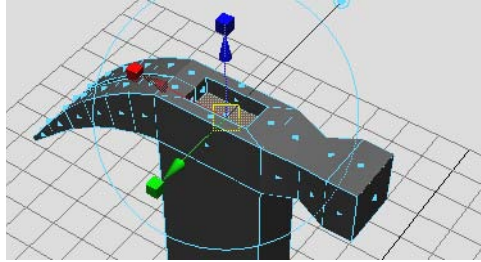

Subdividing polygon faces

A real hammer handle is narrower near the head than at the base. In the next steps, you'll adjust the width of the handle. First, you need to subdivide the faces of the handle to add extra vertices.

Currently the handle has only four vertices, one at each corner. With vertices only at the corners, you can taper the ends of the handle but not other regions. By creating extra vertices throughout the handle, you can tune the shape wherever you choose.

To subdivide the handle

- 1 Shift-select the faces of the handle, including the bottom face. Dolly and tumble the view to see all the faces to select them.

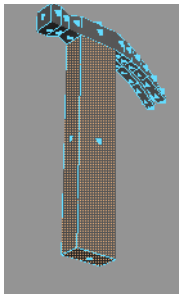

- 2 Select Edit Polygons > Subdivide > . In the options window, enter 2 for Subdivision Levels, then click the Subdivide button.

3 | Polygonal Modeling

Lesson 1 > Subdividing polygon faces

This divides the selected faces into multiple faces with corresponding extra vertices. You can then make fine alterations to the handle's shape.

You could have subdivided the handle faces using the Split Polygons Tool described earlier in the lesson. Subdivide is easier to use because you merely select the face you wish to subdivide. You don't need to select exact positions on the faces. The disadvantage is that you might end up with more faces and vertices than you want to work with.

The advantage of the Split Polygons Tool is that you create only the number of faces and vertices you want, which makes the surface simpler to edit and faster for Maya to process.

- 3 To see the vertices, right-click the hammer and select Vertex from the marking menu. Display the hammer in wireframe mode by clicking the 4 hotkey.
- 4 Scale each row of vertices on the handle inward as desired. A row refers to the vertices that are at the same height along the edges of the handle. If a few vertices lie at an odd location, that is, they lie a little above or below a row, move them into a position even with the row.

Besides scaling a row of vertices, you can also move a row of vertices up or down the handle to alter the contours.

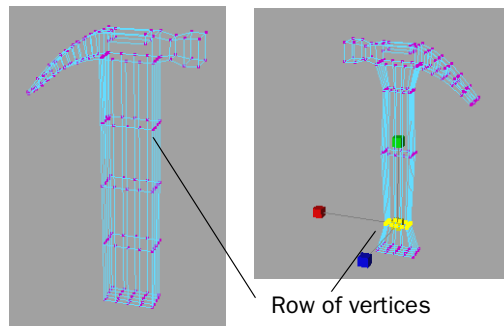

In the next part of the lesson, you'll smooth the edges of the hammer so it looks more authentic. Before doing this, you might want to tune the hammer's shape by modifying your prior extrusions or by moving or scaling vertices.

3 | Polygonal Modeling

Lesson 1 > Smoothing edges

- 5 To modify an extrusion, first select the face or faces, and then select Modify > Transformation Tools > Show Manipulator Tool. Next, click each polyExtrudeFace# in the Channel Box until the extrude manipulator appears on the desired extrusion.

You can move and scale a face with the standard Move Tool rather than the Show Manipulator Tool. However, the Show Manipulator Tool moves the face in the direction of the surface normal rather than in a direction along the View Axis. This surface normal direction is usually the desired direction.

Smoothing edges

Now you'll smooth the edges of the hammer. Smoothing the edges adds more vertices, which means it will be harder to select vertices when you reshape the surface thereafter. Generally it's best to hone the shape as much as possible before you smooth edges.

To smooth the polygon edges and make final modifications

- 1 Decide which edges you want to smooth. For each edge to be smoothed, select the faces that lie on each side of it. For example, to smooth all edges except those on the claw, select the faces as shown in the following illustration.

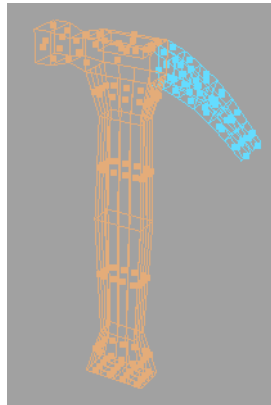

3 | Polygonal Modeling

Lesson 1 > Smoothing edges

- 2 Select Polygons > Smooth. After smoothing, you may see some vertices at improper positions. For example, you might see a vertex jutting out at the base of the handle.



Improper vertex position

- 3 Select each improperly positioned vertex and move it to a position where the surface looks symmetrical. Strive for uniform, regular vertex and edge positions.

If there are improperly positioned edges or extra edges that make the hammer lumpy, you can either select them and move them or delete the unwanted edges by using the Edit Polygons > Delete Edge tool. If you need to add an edge, do so with Edit Polygons > Split Polygons Tool as shown previously in the lesson.

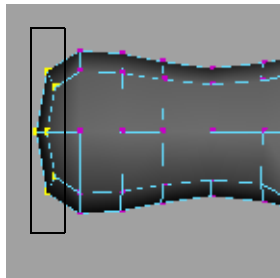

- 4 Notice how the pounding end of the hammerhead has a rounded shape. On a real hammer, this end is flat. To flatten the end, select the vertices there. It's easiest to do this in a front view by dragging a selection box around the vertices.

3 | Polygonal Modeling

Lesson 1 > Smoothing edges

- 5 In the Toolbar double-click the Move Tool so the tool settings window is displayed.
- 6 Turn off Retain Component Spacing under the Move Snap Settings section. This will ensure that the following steps work as described.
- 7 Turn on Snap to Grids: 
- 8 Move the vertices straight out from the head until they snap to a position while working in an orthographic view.
This makes the vertices lie on the same plane, though maybe not the plane you want.
- 9 Turn off Snap to Grids, then drag the vertices back toward the hammerhead to the desired position.

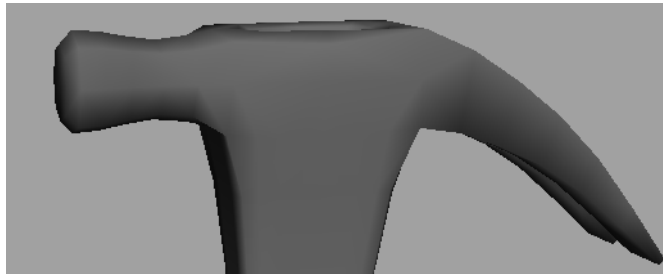

- 10 Feel free to enhance the positioning of other vertices anywhere on the hammer. You can smooth edges more than one time. For example, if you want a more rounded pounding face, select the faces surrounding the edges of the pommel and use Polygons > Smooth again.
The hammer will look smoother when you render an image from the scene as compared to displaying it in the scene view. Examples of rendered images follow:



Beyond the lesson

In this lesson you learned some basic techniques of polygonal modeling:

- You can create complex polygonal models with surprisingly few techniques.
- Starting from a primitive surface such as a cube, you extrude, split, scale, move, and rotate faces of the primitive to create a rough likeness of the object.
- You then adjust vertices to tune the shape, and finally smooth the edges between faces where desired.

Polygonal modeling has many timesaving features not covered in this lesson. For example, Boolean operations (union, intersection, and so on) are a common way to create a new object from the interaction of two existing objects.

If you're planning to use your polygonal surfaces where the poly count is constrained, such as with computer games, Maya has a number of tools for minimizing the number of polygonal faces of an object such as the Reduce Tool. Fewer faces means simpler geometry—This is critical when fewer polygons means increased interactive performance.

“Lesson 2 Sculpting a NURBS surface” on page 122 describes how to use the Sculpt Geometry Tool. With this tool, you can drag your mouse to push, pull, and smooth a surface without first selecting vertices. Though the lesson shows how to shape a NURBS surface, you can apply most of the same techniques when sculpting polygonal surfaces. If you want to learn more about a particular tool or feature that has been presented in this lesson, refer to the Maya Help.

3 | Polygonal Modeling

Lesson 1 > Beyond the lesson

4 NURBS Modeling

NURBS (Non-Uniform Rational B-splines) use a method of mathematically describing curves and surfaces that are well suited to 3D applications. NURBS are characterized by the smooth organic forms they produce.

NURBS surfaces can be quickly modeled and edited using a variety of techniques. NURBS surfaces are created using one or more NURBS curves that define the profile of the shape that you want for a surface, and then using a specific construction method to create the finished surface.

NURBS curves and surfaces have many applications and are the preferred surface type for industrial and automotive designers where smooth forms with minimal data are required to define a particular form. NURBS curves are ideal for defining a smooth motion path for an animated object. With NURBS, a surface can be modeled and then converted to a poly mesh.

In this chapter, you will learn some basic techniques for working with NURBS curves and surfaces in Maya. This chapter includes these lessons:

- “Lesson 1 Revolving a curve to create a surface” on page 116
- “Lesson 2 Sculpting a NURBS surface” on page 122
- “Lesson 3 Lofting curves to create a surface” on page 138

Preparing for the lessons

To ensure the lessons work as described, do these steps before beginning:

- 1** Select File > New Scene to create a new scene before starting each lesson.
- 2** Make sure the Construction History icon (below the menu bar) is on: . (If it is turned off, it has a large X across it.)
- 3** Select the Modeling menu set. Unless otherwise noted, the directions in this chapter for making menu selections assume you've already selected the Modeling menu set.

4 | NURBS Modeling

Lesson 1 > Creating a profile curve

Lesson 1 Revolving a curve to create a surface

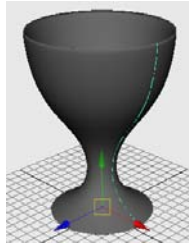

A simple technique for creating NURBS surfaces is to create a curve for the profile of your desired form and then create a surface using one of the various NURBS surfacing tools available in Maya. In this lesson, you create an egg holder using NURBS curves and the Revolve Tool.

In this lesson you learn how to:

- Create a NURBS curve using the control vertice (CV) creation technique.
- Use the grid for visual reference when modeling.
- Determine the start and end points for a NURBS curve and its direction.
- Create a revolved NURBS surface using the Revolve tool.
- Change the display shading smoothness for a NURBS surface.
- Edit a NURBS surface by editing its initial profile curve when it is linked to the surface by construction history.

Creating a profile curve

Revolve is a common modeling technique similar to shaping a vase on a spinning potter's wheel. You must first create a profile curve in an orthographic view and use the Revolve Tool to create a surface.

4 | NURBS Modeling

Lesson 1 > Creating a profile curve

To create a profile curve

- 1 Make sure you've done the steps in "Preparing for the lessons" on page 115.
- 2 Select Panels > Layouts > Four Panes so you can see multiple views of the scene.
- 3 Select Create > CV Curve Tool.

This is the most commonly used tool for drawing curves.

- 4 In the front view, click the numbered positions as shown in the figure. Make sure the first and last positions are on the grid's Y-axis (the thickest vertical line of the front view's grid).

Also, click three times in the same spot for positions 9, 10, and 11. This is necessary to create a sharp point or corner in the curve.

To change the position of the most recent point clicked, you can middle-mouse drag it.

- 5 (Windows and Linux) After you click position 13, press Enter to complete the curve's creation.

(Mac OS X) Press Return to complete the curve's creation.

The points you clicked in the scene view become the control vertices (CVs) of the completed curve. CVs are points you manipulate to alter the shape of a curve (or surface). These points often lie away from the curve.

It takes a little practice to be able to predict exactly where a curve will be positioned when you click CV positions with the CV Curve Tool. Once you've learned the technique, you'll be able to create and edit curves with graceful symmetry. By default, you must click at least four points to create a curve with the CV Curve Tool.

For some advanced operations in Maya, you need to know the meaning of the *start of a curve* and the *curve direction*. The start of a curve is the first CV you create when you draw the curve. It is indicated by a small hollow box at the

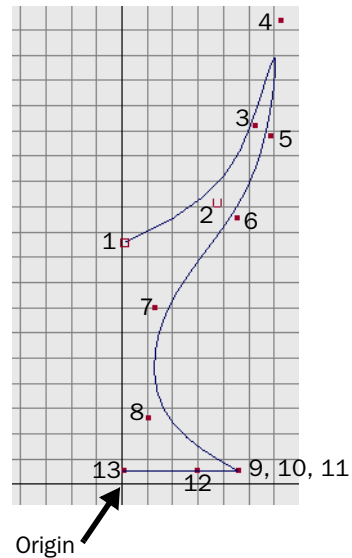

4 | NURBS Modeling

Lesson 1 > Creating a revolve surface

first CV, visible as you create the curve. Curve direction is shown on the second CV after the start of the curve, indicated by a small u icon as you create the curve.

Creating a revolve surface

With the Revolve surface tool, a curve is rotated about an axis to create a surface. The user can define the axis of revolution.

To create a revolve surface

- 1 With the curve selected, select Surfaces > Revolve. This creates the egg holder surface from the revolved profile curve. Examine the results in the perspective view.
Maya does not delete the profile curve. In a subsequent step, you'll edit the profile curve to alter the shape of the surface.
- 2 Select the surface and rename it `Eggholder` in the Channel Box.
- 3 With the pointer in the perspective view, press 5 (for Shading > Smooth Shade All). This displays the egg holder as a shaded surface rather than a wireframe in the perspective view.
- 4 Press 1, 2, and 3 to switch between the different degrees of display smoothness. (These hotkeys correspond to the menu items under Display > NURBS Smoothness.)

The finer the smoothness, the greater the impact is on interactive performance when you work with complex models.

The smoothness display only affects the scene view. Rendered images display with high quality smoothness regardless of this setting.

Editing a revolve surface

After you create a surface from a revolved curve, you can reshape the original creation curve to reshape the surface. This is possible because Maya's Construction History feature was turned on before you did the revolve operation.

4 | NURBS Modeling

Lesson 1 > Editing a revolve surface

Selecting the original creation curve can be challenging when it is situated amongst other existing curves and surfaces. The Outliner is an editor that is useful for quickly examining the structure and components of a scene. The Outliner is also useful for selecting objects in situations like this.

To edit a surface with construction history

- 1 Select Window > Outliner.

The Outliner appears and displays a list of the items in the scene.

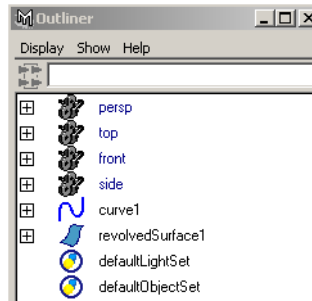

- 2 In the Outliner, select the curve you revolved (curve1) by clicking on its name in the list.

The curve becomes highlighted in the scene views.

- 3 In the front view, right-click in the view and select Control Vertex from the marking menu.

The CVs for the curve appear.

- 4 Select and move one or more CVs to adjust the curve shape as desired.

If you have trouble selecting one of the CVs in the front view, select it in the perspective view after dolly and tumbling the camera as necessary.

This modifies the shape of the egg holder because it is linked to the shape of the curve by its construction history.

4 | NURBS Modeling

Lesson 1 > Beyond the lesson

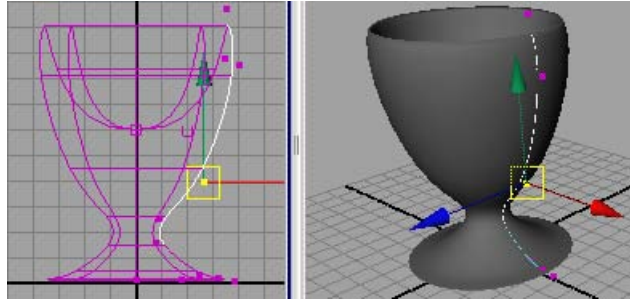

- 5 If desired, save the scene for future review.
- 6 Close the Outliner window.

Beyond the lesson

In this lesson you were introduced to a few basic techniques related to NURBS modeling:

- Revolving a curve is the easiest way to create surfaces with radially symmetrical forms— wheels, vases, glasses, pillars, and so on.
- NURBS surfaces are webs of interconnected curves. The creation curves are used to create and subsequently modify the surfaces if required.
- Proficiency at drawing and editing curves is an important part of NURBS modeling.
- The grid is a useful aid for constructing and modifying curves.

Some additional points you should know are:

- You cannot render curves, so your work with them is always an adjunct to creating and editing surfaces.
- Besides moving a curve's CVs to alter its shape, you can cut, attach, extend, close, and smooth curves.

4 | NURBS Modeling

Lesson 1 > Beyond the lesson

- After you create a surface from a revolved curve, you can edit the surface at a component level by moving CVs or scaling groups of CVs on that surface to customize the shape of the surface. (You will need to turn off construction history in order to do this.)

4 | NURBS Modeling

Lesson 2 > Preparing a surface for sculpting

Lesson 2 Sculpting a NURBS surface

In addition to creating NURBS surfaces using curves, you can edit and sculpt surfaces and primitive objects in Maya using the Sculpt Geometry Tool.

The Sculpt Geometry Tool allows you to interactively push or pull on the surface regions to create areas that are embossed or in relief in relation to the surface.

In this lesson, you learn some of the basic concepts of these tools by sculpting a cartoon face and head from a NURBS primitive sphere using the Sculpt Geometry Tool.

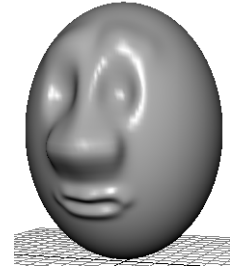

In this lesson you learn:

- Basic sculpting operations (push, pull, smooth, and erase) with the Sculpt Geometry Tool.
- How the density of isoparametric lines affects the surface detail possible when sculpting.
- How to increase the surface subdivisions on a NURBS surface to aid with surface sculpting.
- How to change the brush radius for the Sculpt Geometry Tool.
- How Opacity and Max Displacement affect the sculpting operations.
- How to import geometry from a pre-existing file into your current scene.

Preparing a surface for sculpting

Because a head is roughly spherical, you can create a primitive sphere as a quick starting point for creating a head and face.

To prepare a sphere for sculpting

- 1 Make sure you've done the steps in "Preparing for the lessons" on page 115.

- 2** Select Create > NURBS Primitives > Sphere > . In the options window, select Edit > Reset Settings, enter the following values, then click the Create button:
- Radius: 6
 - Number of Sections: 30
 - Number of Spans: 30

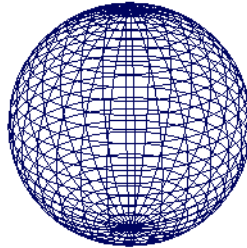

The Radius sets the sphere's size in grid units. A value of 6 creates a sphere big enough to use the grid for size comparison.

The Number of Sections sets the number of vertical curves, called *isoparms*, for the sphere. Isoparms show the outline of the surface shape. The more isoparms a surface has, the more CVs it has. (By default, CVs are not displayed.) More CVs means better precision as you edit a surface. The Number of Spans sets the number of horizontal isoparms.

The drawback to having too many CVs is that you'll have a harder time making smooth shape changes to broad regions. Lots of CVs also means slower processing time as you work with the surface. It's best to make surfaces with as few CVs as necessary.

We chose 30 Sections and Spans for this lesson because experience has shown that this allows adequate facial subtlety without slowing Maya operation on a workstation of modest processing power.

4 | NURBS Modeling

Lesson 2 > Preparing a surface for sculpting

Note In wireframe display mode, if you select Display > NURBS Smoothness > Fine or Medium, more isoparms appear than there are actual spans and sections. The surface is visually displayed with extra precision, but the extra isoparms have no CVs and cannot be edited.

- 3 Name the sphere `Egghead`.
- 4 Rotate the sphere 90 degrees on its side (Rotate Z: 90). This positions the sphere's CVs well for modeling a simple head and face. You'll learn why later in this lesson.
- 5 To give Egghead an oval shape, set the ScaleX for the sphere to 1.3 or so. Optionally, you can move Egghead above the grid so the grid doesn't interfere with your view of Egghead. Also, position the camera view so the Z-axis of the View Axis points toward you.

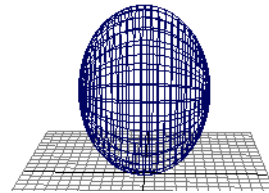

Modifying the surface material for easier viewing

Because you will do subtle surface modeling in this lesson, it's helpful to display Egghead with bright highlights so you can clearly see the effects of the changes you make. In the next steps, you'll assign a Blinn material to Egghead to give its surface bright highlights. The steps have no explanations, as the shading subject matter is the focus of a later lesson.

To assign a Blinn surface material

- 1 With Egghead selected, press 5 to display the surface with smooth shading.
- 2 Right-click Egghead and select Materials > Assign New Material > Blinn. The Attribute Editor will immediately be displayed for the Blinn material.
- 3 Drag the Color attribute slider roughly 3/4 of the way to the right, set Eccentricity to 0, and close the window.

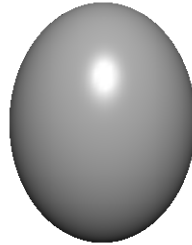

Basic sculpting techniques

In the next steps, you'll become familiar with features of the Sculpt Geometry Tool. With this tool, you use your mouse or stylus to push, pull, or smooth a surface's shape without selecting or displaying CVs. After you practice sculpting the surface, you'll erase your practice strokes then begin sculpting Egghead's features.

To practice sculpting using basic sculpting operations

- 1 With Egghead selected, select Edit NURBS > Sculpt Geometry Tool > . In the Tool Settings window, click Reset Tool, and make sure the Sculpt parameters are displayed.

In the Sculpt Parameters section, there are four operations for sculpting a surface. Each affects the region of the surface where you drag (*stroke*) your mouse or stylus relative to the surface normals:



- The *Push* operation depresses the surface in the region of the stroke.
- The *Pull* operation raises the surface in the region of the stroke.
- The *Smooth* operation diminishes bumps or ridges where you drag.
- The *Erase* operation eliminates the effects of the other three operations. The Erase operation works up to the last time you saved the scene or clicked the Update button to the right of Erase Surface.

4 | NURBS Modeling

Lesson 2 > Basic sculpting techniques

- 2 Experiment with each of the four operations on the surface. Don't be concerned with the results. Just become familiar with the response to your mouse strokes.

By default, Push and Pull strokes deform the surface in a direction normal (perpendicular) to the surface. To create the resulting deformation more accurately, use Push and Pull strokes in a front, side, or top view while examining the results in a separate perspective view. Tumble the perspective view regularly for best visual feedback.

When you position the mouse pointer on the surface, it changes to a red sculpt icon that shows an abbreviation for the name of the operation you are performing. For instance, Ps stands for Push.

The red icon also displays the radius of the region affected by the stroke. The Radius(U) value changes the radius.

- 3 Select the Erase operation and click the Flood button. This erases all your changes.

- 4 Select the Pull operation and enter a Radius(U) of 0.25, then drag between a pair of horizontal isoparms without crossing either.

This has no effect because the stroke radius didn't make contact with the CVs of either isoparm. Regardless of which operation you use, only CVs are affected by the strokes.

- 5 Change the Radius(U) to 2 and repeat the prior strokes.

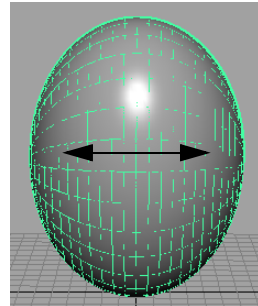

4 | NURBS Modeling

Lesson 2 > Basic sculpting techniques

The strokes alter the surface because the radius overlaps the CVs. As this example shows, you need to make sure the radius is big enough to influence the desired CVs. It's common to change the radius many times during a sculpting session.

If you prefer to affect a small region without increasing the radius, you can add CVs to the region by inserting more isoparms. You'll do this later in the lesson.

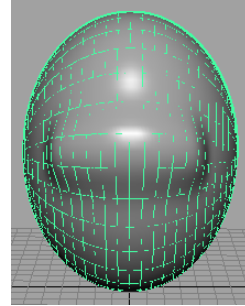

- 6 Flood-erase the changes to the surface as you did previously.
- 7 Select the Pull operation with a Radius(U) of 0.5. Drag along a vertical isoparm. For comparison, drag along a horizontal isoparm.

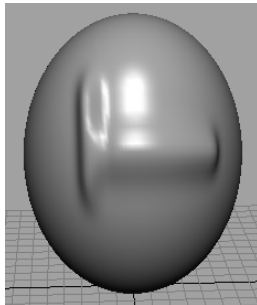

Before taking the snapshot for this figure, we set the Wireframe on Shaded on the Display tab to None (Window > Setting/Preferences > Preferences). This turned off highlighting of the surface isoparms, making surface alterations easier to see. Consider switching between the off and on settings for Show Wireframe as you learn the Sculpt Geometry Tool.

The vertical stroke creates a thinner ridge than the horizontal stroke because the density of vertical isoparms is greater. The number of underlying CVs and their positioning affects the outcome of your strokes.

Tip

You can alternatively adjust the radius of the Sculpt Geometry Tool using a Hotkey. Move the tool over the object, press and hold the b Hotkey and drag left or right. The circle on the object with numerical radius value represents the size of your tool. Stroke on the object to try out a new size

- 8 Flood-erase the changes to the surface as you did previously.

4 | NURBS Modeling

Lesson 2 > Additional sculpting techniques

- 9 Rotate the camera view so the X axis of the View Axis points toward you. Draw a vertical Pull stroke again.

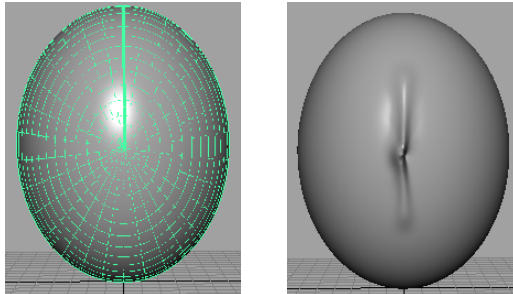

As your stroke nears the center of Egghead, a kink occurs. It's challenging to alter a surface symmetrically in a region where many isoparms converge at a single point, called a *pole*. Always consider the position of isoparms as you sculpt a surface. In general, sculpt where isoparms are evenly, regularly distributed.

- 10 Erase all changes again, then reposition the camera view so the Z-axis of the View Axis points toward you.

Tip If the Sculpt Geometry Tool is selected but not the surface you want to work on, right-click the surface and select Select from the marking menu.

Additional sculpting techniques

Now that you've learned the basic features, you'll learn other useful techniques before starting to model the facial features.

To practice additional sculpting techniques

- 1** In the Sculpt Parameter section of the Sculpt Geometry Tool, set Max Displacement to 2.
- 2** Draw a vertical Pull stroke.
- 3** Change the Max Displacement to 1.
- 4** Draw another vertical stroke nearby.
The Max Displacement sets the maximum distance the surface's CVs are pushed (or pulled) with a single stroke.
- 5** Erase the changes to the surface.
- 6** Set Max Displacement to 2.
- 7** Draw a vertical Pull stroke.
- 8** Set the Opacity from the default value of 1 to a value of 0.2.
- 9** Draw another vertical stroke nearby.

One ridge is higher than the other. The Opacity value scales the influence of Max Displacement. For example, with an Opacity of 0.2, each stroke has only roughly 0.2 times the effect of the Max Displacement setting.

It's generally best to use a low Opacity value as you Push or Pull. You can increase the deformation gradually with multiple strokes.

If you want to affect only a small region of a surface, use your mouse to click rather than stroke the region. If the Radius(U) and Opacity of the brush is small, you might need to click the nearest intersection point of two isoparms.

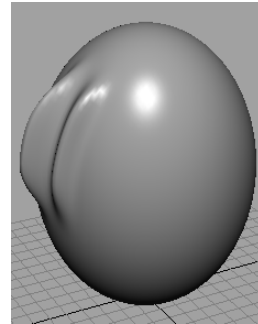

4 | NURBS Modeling

Lesson 2 > Sculpting a nose

10 With Opacity set to 1, erase all changes to the surface again.

Tip

Consider using an electronic tablet with pen stylus. A pen stylus is more natural for stroking surface changes as it feels like a pen. With a stylus, you can set an option that causes the Radius or Opacity to vary with stylus pressure. For example, you can have heavy strokes create a bigger Radius than light strokes.

To do this, display the Stroke tab of the Sculpt Geometry Tool. For Stylus Pressure, select Opacity, Radius, or Both. Radius is a common choice. If you select Radius, the Radius(U) value on the Sculpt tab sets the maximum radius, while Radius(L) is the minimum. Explore various settings.

If you use a mouse, set the Stylus Pressure to None. The Radius(U) sets a fixed radius. Radius(L) is ignored.

Sculpting a nose

Now you'll begin sculpting Egghead's face, starting with a simple nose.

To sculpt a nose for the character

- 1** Position the perspective view so the Z-axis of the View Axis points toward you.
- 2** Reset the Sculpt Geometry tool.
- 3** Select the Pull operation and set the following options:
Radius(U): 1
Opacity: 0.2
- 4** Select this Shape setting so your strokes have a soft, faded edge: 
- 5** Above the midpoint of Egghead, stroke vertically downward from the top of the nose to the tip—about the distance between two horizontal isoparms (see the following illustration). Use several strokes to build up the bridge of the nose. Create nostrils by stroking horizontally to the right of the tip of the nose a few times, then to the left of the tip a few times.

To build up a small area, position the stroke icon there and click the mouse rather than drag. Tumble the view to examine your results after each stroke or click.

If the strokes create a bumpy surface, turn on the Smooth operation and click Flood once or twice to smooth all strokes on the surface. Because Opacity is 0.2, the Smooth operation is subtle. Alternatively, you can smooth a selected region by stroking just that area. It's common to smooth a surface regularly while using pull and push strokes.

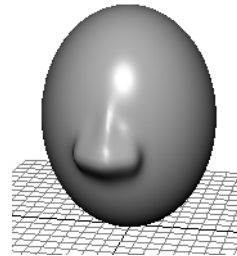

Because there are relatively few isoparms in the nose area, you can only create a simple nose that's broad and rounded. If you want to create sharper features, for instance, depressed nostrils or sharp ridges, you'll need to insert isoparms in the nose region. "Sculpting a mouth" on page 133 describes how to insert isoparms.

Sculpting eye sockets

Eye sockets provide an inset and backdrop for eyes.

To sculpt eye sockets for the character

- 1 Select the Push operation.
- 2 Leave other settings the same as for the nose.
- 3 To make a pair of identical eye sockets, display the Stroke settings in the Tool Settings window and turn on Reflection.
- 4 Set the Reflection Axis to Z and then position the sculpt icon on Egghead. A pair of identical Push icons appears on Egghead.
- 5 Adjust the positioning as desired for the eye sockets. Click the mouse many times in the desired location.

4 | NURBS Modeling

Lesson 2 > Sculpting eyebrows

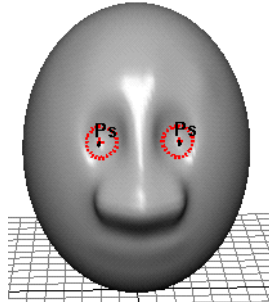

In your future work, keep in mind that on some surfaces, the position of the mirrored stroke icons might appear vertically or diagonally opposite one another rather than horizontally. There's a simple technique for adjusting the positioning. With Reflection and U Dir turned on, try various slider positions for U Dir. If the positioning isn't correct, turn on V Dir and try various slider positions for V Dir. Make subtle adjustments by moving the brush icon.

Sculpting eyebrows

Eyebrows help define how stern or pleasant a face appears.

To sculpt eyebrows for the character

- 1 Select the Pull operation. Use the same option settings as for the eye sockets, including Reflection.

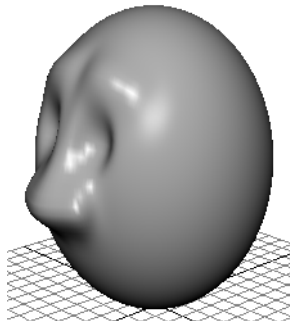

- 2 Position the sculpt icons above the eyes and draw horizontal strokes. If necessary, click positions where you need to build up the eyebrows. Smooth the eyebrows as necessary.

Sculpting a mouth

With the 30 Sections and 30 Spans specified for the original sphere in this lesson, the large space between isoparms in the mouth region makes it impossible to create a subtle shape for the lips.

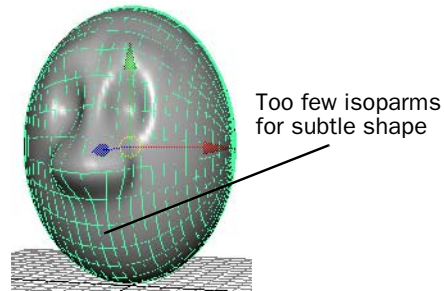

To overcome this problem, you must insert isoparms in the mouth region before sculpting.

To insert additional isoparms

- 1 Right-click Egghead and select Isoparm from the marking menu.
- 2 From the Toolbox, choose the Select Tool.



- 3 Click the horizontal isoparm below the nose and shift-click the next two below it.

4 | NURBS Modeling

Lesson 2 > Sculpting a mouth

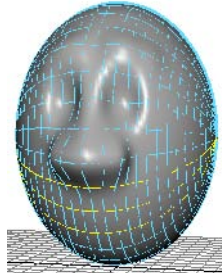

- 4 Select Edit NURBS > Insert Isoparms > . In the options window, turn on Between Selections, enter a value of 2 for # Isoparms to Insert, then click Insert.

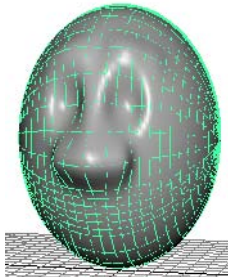

This inserts two extra isoparms between each pair of selected isoparms, for a total of four extra isoparms. This provides enough CVs to create subtlety in the mouth.

You might want to add vertical isoparms at the lips in a similar way. The extra isoparms would also be useful if you were to later enhance the shape of the nose. Insert isoparms only where needed. More isoparms means slower processing speed.

In any case, do not change the number of isoparms by editing the original number of Sections and Spans in the makeNurbSphere history node. This will reshape your sculpted surface undesirably.

To sculpt a mouth for the character

- 1 Select the Sculpt Geometry Tool again.

- 2 Select the Push operation. Enter 0.2 for Radius(U). In the Stroke tab, make sure Reflection is turned on.
- 3 Starting at the center of the area appropriate for the indentation between the lips, stroke outward from the center. It's best to start the stroke with the dual icons on top of one another (in other words, only one icon is displayed).
- 4 Select the Pull operation and set the Radius(U) to 0.3. Using a similar technique as for the prior step, stroke the upper lip. Repeat for the lower lip.



Note It might be easier to push or pull the lips with the Ref. Vector set to Z Axis. This moves the region you stroke in the world Z-Axis direction. The default Normal setting moves the region in a direction normal (perpendicular) to the surface. Because the normal direction on a lip might be up, down, or straight out, depending on the part of the lip you stroke, there's more possibility of undesired results when you use the Normal setting.

Sculpting other facial features

You can now optionally add other facial features. Consider these tips:

- For facial features such as the chin, cheeks, and forehead, use a Radius(U) larger than 1 and start with a Maximum Displacement between 0.5 and 1.
- Insert isoparms wherever you want to add extra detail with the Sculpt Geometry Tool.

4 | NURBS Modeling

Lesson 2 > Beyond the lesson

- To create eyeballs for the sockets, create a sphere and scale it as necessary to fit the socket. You might want to increase the eyeball's Scale X value to make it oblong. To duplicate the eyeball, and make a mirrored copy of the original you'll first need to set the pivot point for the eyeball to be at the origin 0, 0, 0 using the following steps. With the sphere selected, press the Insert (Windows and Linux) or Home (Mac OS X) key so that the sphere's pivot point is displayed. Next move the pivot point to the origin using the X hotkey so that the pivot snaps to the grid at 0, 0, 0. Select Insert (Home) to turn off the pivot point display. Finally, use Edit > Duplicate >  and set the Scale setting to -1, 1, 1. This makes the new eyeball a mirrored duplicate of the original on the opposite side of Egghead's face. Position the eyeballs in the sockets. Parent the eyeballs to Egghead.
- To create simple, unadorned ears, you can create, scale, and squash a sphere. Create ridges and valleys by pulling CVs or by using the Sculpt Geometry Tool. Duplicate the ear by first setting its pivot point to the origin and with the Scale option set to -1, 1, 1. Parent the ears to Egghead.

To import existing models into your scene:

If you saved the Eggholder scene in the prior lesson, you can import the egg holder into this Egghead scene, then position Egghead into the egg holder.

- 1** To import the egg holder into the Egghead scene, use File > Import and select the name of the scene that contains Eggholder.
Importing a scene imports all objects from that scene.
- 2** Increase (or decrease) the scale of the egg holder (or Egghead) as necessary for a snug fit.



Beyond the lesson

In this lesson you were introduced to a few basic techniques related to sculpting surfaces:

4 | NURBS Modeling

Lesson 2 > Beyond the lesson

- The Sculpt Geometry Tool is indispensable for quickly shaping a variety of surfaces. As you do your own projects, pay special attention to the position and density of isoparms before you begin sculpting.
- Isoparms converge at a single point (the *pole*). Pole regions of a primitive or surface are hard to sculpt so it's best to avoid using the Sculpt Geometry Tool there. For example, when you created the original sphere in this lesson, you rotated it 90 degrees around its Z-axis. Because of the rotation, ears for the head would need to be modeled via a different technique (for example, you could model a pair of ears and parent them to the head).
- The density and orientation of isoparms on a surface affects the results with the Sculpt Geometry Tool. As you gain NURBS modeling experience, you'll learn how to use the density and orientation of isoparms to your advantage.
- Primitive objects are useful objects for sculpting in many cases. After you create a primitive, you typically sculpt, scale, trim, or otherwise alter the object into a more complex shape. Though most primitives are surfaces rather than curves, they still derive their shape from curves.



In general, a sphere makes a convenient foundation for creating a simple head, but it's not ideal if you plan to animate an expressive, talking head. Many 3D artists start with a cylinder or a lofted surface. The procedures for doing this are more complex than starting with a sphere and are beyond the scope of this lesson.

4 | NURBS Modeling

Lesson 3 > Creating profile curves for a surface

Lesson 3 Lofting curves to create a surface

Another method for creating NURBS surfaces is to loft a series of curves that define the cross section of your desired surface form. Lofting a surface works like stretching a skin over each of the cross sections to create the final surface.

In this lesson, you learn additional NURBS surfacing techniques by using the Loft tool to create the body of a salt shaker. You will also create the cap for the salt shaker by modifying the shape of a primitive sphere.



In this lesson you learn how to:

- Modify the outline of a circle primitive by editing the position of its CVs.
- Use the magnet snap feature.
- Loft cross section curves to create a NURBS surface using the Loft tool.
- Edit the form of an existing primitive object by moving its CVs.
- Parent one object to another using the Outliner.

Creating profile curves for a surface

You begin the lesson by creating a pair of profile curves. You then create several copies of these curves to form the skeletal contours of the salt shaker's surface.

To create profile curves for the salt shaker's body

- 1 Make sure you've done the steps in "Preparing for the lessons" on page 115.
- 2 Select Create > NURBS Primitives > Circle > . In the options window, select Edit > Reset Settings, enter the following values, then click the Apply button:
 - Radius: 4
 - Number of Sections: 24

The Radius sets the size of the circle in grid units. A value of 4 creates a circle with enough size so that you can use the grid for convenient size comparison.

4 | NURBS Modeling

Lesson 3 > Creating profile curves for a surface

The Number of Sections sets the number of CVs in the circle. By using 24 CVs, you can create a circle with the subtle contours required in this lesson. Display the CVs of the circle to see the 24 CVs.

A circle is a curve that loops back on itself. The CVs work the same way as for any other curve. The more CVs you create for a curve or surface, the more detail you can give its shape.

The drawback to using many CVs is that you'll have a harder time making smooth shape changes to broad regions. Also, more CVs means slower processing time as you work with the curve. It's best to make curves with as few CVs as necessary. With experience, you'll learn how many CVs to use in a situation.

3 Create another circle, this time with these options:

- Radius: 2
- Number of Sections: 24

This creates a smaller circle inside the first circle as shown below.

4 Change the scene view so you can see the circles from the top view.

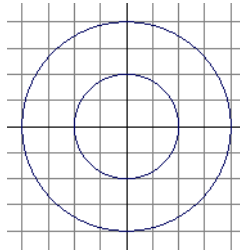

5 Right-click the inner circle and select Control Vertex from the marking menu. Repeat for the outer circle.

6 Turn on Snap to Points (below the menu bar). 

7 As shown in the following figure, move CVs from the outer circle to the corresponding inner circle positions. As you drag a CV near its destination, the Snap to Points mode causes the CV to jump to the exact CV position.

4 | NURBS Modeling

Lesson 3 > Duplicating curves

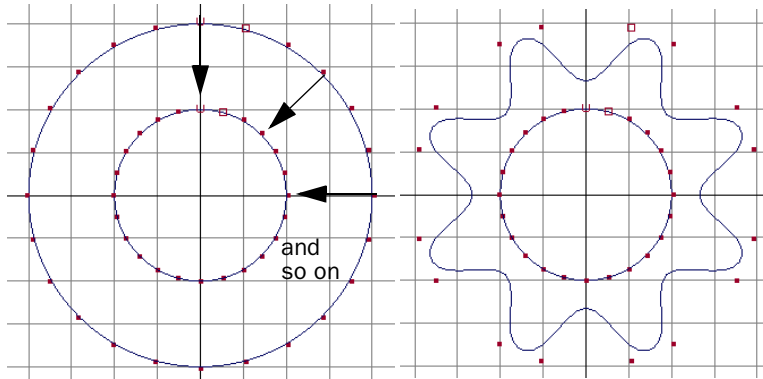

- 8 Turn off Snap to Points. Turn off the display of CVs for both circles by right-clicking on the circles and selecting Object Mode from the marking menu.

Duplicating curves

In the next steps, you'll create several copies of the previously created circles (also called *curves*) to form the skeletal contours of the salt shaker's surface.

To duplicate curves for the lofted surface

- 1 Right-click the outer curve and choose Select from the marking menu.
- 2 Select Edit > Duplicate > . In the options window, select Edit > Reset Settings, enter the following values, then click Duplicate:

- Translate: 0 3 0
- Scale: 0.93 1 0.93
- Number of Copies: 4

This creates four copies of the original curve, each translated three units above the last, and each scaled smaller than the last.

- 3 Select the inner circle and then move it to 0, 13, 0 by entering these translate values in the Channel Box. Increase its Scale attributes to 1.33, 1.33, 1.33.

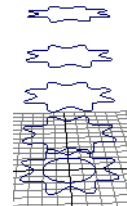

4 Use Edit > Duplicate > with the following options:

- Translate: 0 2 0
- Scale: 1.05 1 1.05
- Number of Copies: 3

This creates three copies of the circle, each translated two units above the last, and each bigger than the last.



Lofting a surface

You've created a total of nine curves. In the next steps, you loft these curves into a surface that matches the contours of their perimeters. Above the midpoint of the surface, the shape will change from a flower-shaped perimeter to a circular perimeter.

To loft a surface for the salt shaker's body

1 Shift-select all circles, one at a time.

The order of selection is important when shift-selecting for a loft operation. You must start with the bottom flower-shaped circle and end with the top circular-shaped circle. Alternatively, you can drag a selection box around the circles. The surface to be lofted will be based on the selection order of the curves.

2 Select Surfaces > Loft.

This creates the salt shaker's body.

3 Name the surface `shakerBody`.

4 Press 5 to display the view with smooth shading.

4 | NURBS Modeling

Lesson 3 > Modifying a primitive object



Lofted surface set to smooth shaded mode

Note Many of the surface creation tools also have the option of creating polygon or subdivision surface versions of a surface with the same input curves. You do this by setting the appropriate Output Geometry option for that particular surface tool.

Modifying a primitive object

To create a simple cap for the salt shaker, you'll create a sphere, alter its shape, and position it above the body.

To create and modify a sphere for the salt shaker's cap

- 1** Select Create > NURBS Primitives > Sphere > . In the options window, select Edit > Reset Settings, and click the Create button. Maya puts the sphere at the origin, its display currently obstructed by the salt shaker body.
- 2** Name the sphere `Cap`.
- 3** Move the cap to the top of the body

4 | NURBS Modeling

Lesson 3 > Using the Outliner to parent objects

- 4 Scale the cap size so that its diameter fits snugly at the top of the body.
- 5 Adjust the cap's position as desired.
- 6 In a side view, make sure that the cap is displayed as a wireframe.
- 7 Right-click on the Cap and choose Control Vertex from the marking menu.
- 8 Select the top row of CVs and drag them down until the top of the cap is flattened:

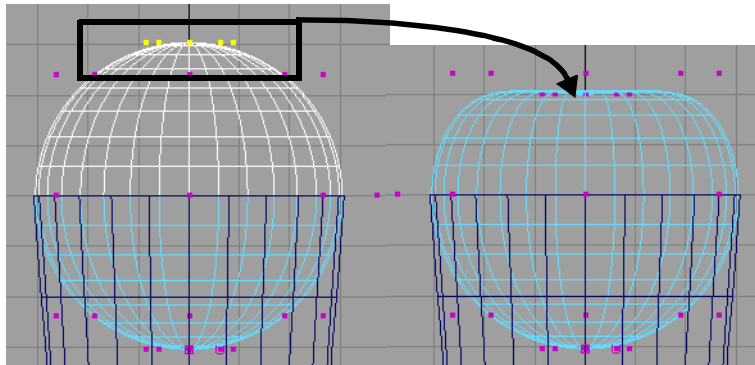

Check that the bottom half of the cap isn't poking through the visible surface of the body. You can scale the bottom CVs inward to avoid this problem.

Using the Outliner to parent objects

The Outliner is an editor that is useful for quickly examining the structure and components of a scene. You can use the Outliner to quickly parent objects to create an object hierarchy.

4 | NURBS Modeling

Lesson 3 > Beyond the lesson

To parent an object using the Outliner

- 1 From the main menu, select Window > Outliner.
The Outliner window is displayed. A list of the scene's components is listed in the Outliner.
- 2 In the Outliner, click on the word *Cap* to select it.
- 3 Parent the cap to the body by middle-mouse dragging *Cap* onto *Body* in the Outliner.

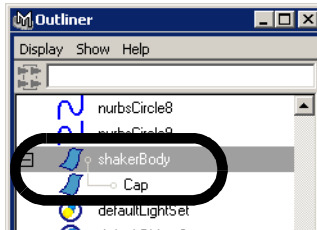
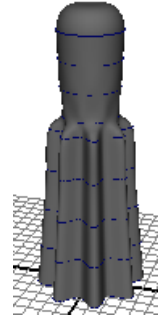

By parenting the objects, you can move, rotate, or scale the cap and the body as a single entity by selecting only the body.

Notice that the salt shaker displays horizontal curves that wrap around the body. The curves are the original circles you used to loft the surface. Because these curves are part of the surface's construction history, you can alter their shape if you decide you want to alter the shape of the body and the body will update based on the construction history.

If you prefer not to see the curves in the scene view, select the curves and select Display > Hide > Hide Selection. The curves won't appear when you render an image of the scene. Maya displays only surfaces, not curves, in rendered images.

Beyond the lesson

In this lesson you were introduced to the basic techniques related to lofting curves to create NURBS surfaces:

Getting Started with Maya

4 | NURBS Modeling

Lesson 3 > Beyond the lesson

- You made a salt shaker with two surfaces: a body made from lofted curves and a cap made from an altered sphere. An advantage of creating a separate surface for the cap and base is that you can easily give each a different color or texture, for example, one chrome and the other marble. Another advantage of creating a separate cap is that you can animate the object separately. For example, you could choose to animate the cap unscrewing from the shakerBody.
- You used a Loft operation rather than a Revolve operation to create the body. The vertical corrugations on the surface would be impossible to create by revolving a curve.
- You can alter the position of the profile curves and the shape of the shaker will update because of the construction history. If you're certain you won't change the body's shape by editing the shape of the lofted curves, you can delete the body's construction history to quicken Maya's processing of your interaction with the surface. (For a surface as simple as the salt shaker, deleting the history won't boost processing much.)
- There are many other useful tools for creating and editing surfaces. For a glimpse of the possibilities, take a look at the Surfaces menu and the Edit NURBS menu.

If you want to learn more about a particular tool or feature that has been presented in this lesson, please refer to the Maya Help.

4 | NURBS Modeling

Lesson 3 > Beyond the lesson

5 Subdivision Surfaces

Subdivision surfaces are a hybrid surface type that possess characteristics of both NURBS and polygonal surfaces as well as other features not offered by the other surface types. Like NURBS, subdivision surfaces are capable of producing smooth organic forms and can be shaped using relatively few control vertices. Like polygonal surfaces, subdivision surfaces let you extrude specific areas and create additional detail in your surfaces. You do this by working at different levels of detail on the subdivision surface and switching between the levels when necessary. With a subdivision surface you can build a smooth organic object from a single primitive and not be concerned about attaching or stitching the various surfaces together as you would for a NURBS surface.

Preparing for the lesson

To ensure the lesson works as described, do these steps before beginning:

- 1** Read Chapter 3, “Polygonal Modeling.” Knowledge of polygonal modeling tools is essential to becoming proficient in subdivision surface modeling.
- 2** Create a new scene.
- 3** Select the Modeling menu set.
- 4** Select Window > Settings/Preferences > Preferences.
- 5** In the Preferences window, select Subdivs from the Categories list to display the subdivision surface preferences.
- 6** In the Subdivision Surfaces Component Display settings, set the Component display to Numbers, then click Save.

By default, the subdivision surface components display as points. For this lesson, you set the components to display as numbers to see the subdivision surface level directly on the surface.

5 | Subdivision Surfaces

Lesson 1 > Creating a subdivision surface

Lesson 1 Modeling a subdivision surface

In this lesson you learn some of the basic tools for working with subdivision surfaces as you model a human character's hand.

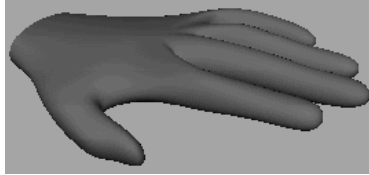

In this lesson, you learn how to:

- Convert a polygon surface to a subdivision surface.
- Work with subdivision surfaces in Polygon Proxy Mode.
- Split subdivision faces to create areas for more detail in a model.
- Extrude the split faces to create fingers on the hand.
- Work with subdivision surfaces in Standard Mode.
- Change the Display Level when working in Standard Mode.
- Add more detail to subdivision surface models using Refine Selected Components.
- Create a crease along a vertex edge.

Creating a subdivision surface

You begin the lesson by creating a polygonal cube. You'll convert this cube to a subdivision surface that will be the foundation of the hand. The reason for starting with a polygonal surface and converting it to a subdivision surface is that you can thereafter edit the object's shape with more versatility. You can edit with subdivision surface tools *and* polygonal tools.

5 | Subdivision Surfaces

Lesson 1 > Creating a subdivision surface

To create a polygon cube

- 1 Select Create > Polygon Primitives > Cube > . In the options window, select Edit > Reset Settings. Then enter the following values and click the Create button.
 - Width: 8
 - Height: 2.5
 - Depth: 8

The resulting polygonal cube is roughly proportional to the palm of a hand.

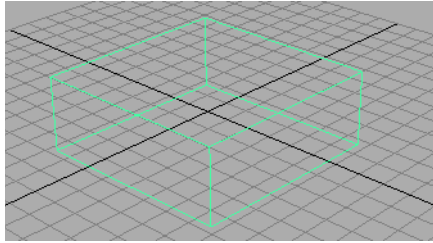

To convert a polygonal cube to a subdivision surface

- 1 To convert the polygonal cube to a subdivision surface, select Modify > Convert > Polygons to Subdiv.

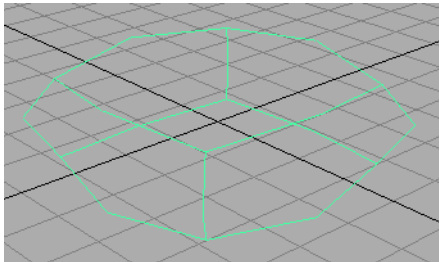

- 2 Press 3 on your keyboard (to select Display > Subdiv Surface Smoothness > Fine).
- 3 Press 5 (to select Shading > Smooth Shade All).

5 | Subdivision Surfaces

Lesson 1 > Creating a subdivision surface

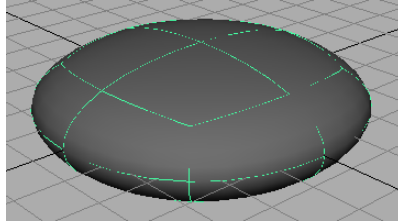

With the Smoothness set to Fine, you can see that the conversion to a subdivision surface creates a rounded, smooth shape. By pressing 3, the subdivision surface is displayed more precisely in the scene view. This gives a closer approximation of what the surface will look like when you create a rendered image of the scene.

As an alternative, you could have chosen a rough smoothness (press 1) so that Maya processes your editing changes in the scene view more quickly. Regardless of the smoothness in the scene view, surfaces always are displayed precisely in rendered images of the scene.

To display a subdivision surface in polygon proxy mode

- 1 Select Subdiv Surfaces > Polygon Proxy Mode.

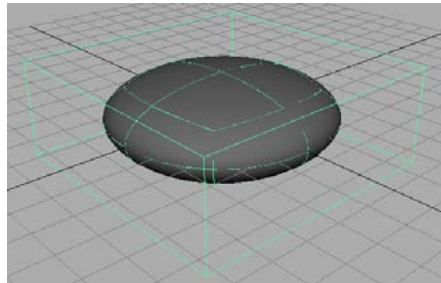

The wireframe cube looks the same as the original polygonal cube. The new cube is called a *polyToSubd1* for the subdivision surface as a result of the conversion. Rename it *LeftHand*. You can use polygonal modeling tools to edit the shape of the polygonal proxy, which indirectly alters the shape of the subdivision surface. Unlike working with an actual polygonal object, your modifications result in perfectly smooth surface changes rather than faceted changes.

Splitting a surface in polygon proxy mode

Next, you use polygonal modeling techniques to split a face into multiple faces to be extruded as fingers.

To split the polygon face into multiple faces

- 1 With LeftHand still selected, select Edit Polygons > Split Polygon Tool. You'll use this tool to split the front face of the proxy into several faces to be extruded into fingers.
- 2 In the front view, click the point on the top edge as shown in the following figure, then click the corresponding point directly below it on the bottom edge. If the line between the points isn't perfectly straight, use the middle mouse to drag the second point to the correct position. Press Enter (Windows and Linux) or Return (Mac OS X).

Click at these locations and press Enter (Return).

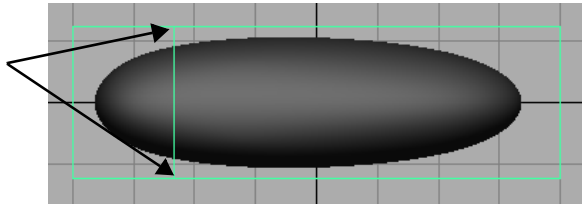

This splits the face into two faces. You'll extrude the left face into a finger later.

- 3 Repeat the preceding two steps as necessary to split the face as follows:

Repeat the steps for these points. Then repeat for the remaining faces.

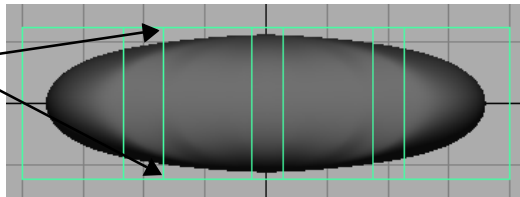

Notice how splitting the face into multiple faces alters the shape of the subdivision surface. The front part of the subdivision surface now resembles the proxy shape more. If you were to split the front face several more times,

5 | Subdivision Surfaces

Lesson 1 > Extruding polygon faces

especially near the outer edges, the subdivision surface would sharpen and resemble the proxy shape even more. More faces means finer control, often at the expense of making the surface harder to work with.

With the added faces, the subdivision surface looks a bit like the palm of a hand. You'll build upon this shape to create a left hand with palm facing downward and fingers extruded outward. You'll extrude the wide faces into fingers, and you'll leave the narrow faces as webbing between the fingers.

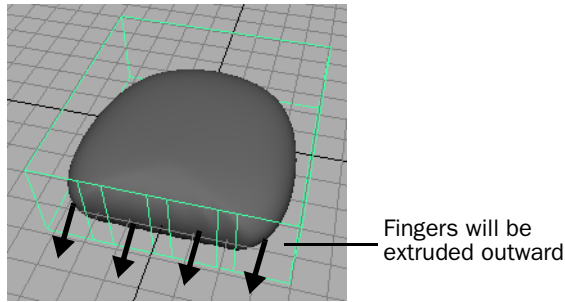

Extruding polygon faces

Next, you'll extrude faces to create fingers for the hand.

To extrude the polygon faces to create fingers

- 1** In a perspective view, right-click LeftHand and select Face from the marking menu.
This lets you select faces.
- 2** Select the right-most face by dragging a selection box around the tiny box at its center. (The subsequent illustration shows which face to select.)
- 3** Select Edit Polygons > Extrude Face.
- 4** Drag the blue arrow manipulator outward a little to create the first segment of the smallest finger.

The blue arrow turns yellow when selected.

5 | Subdivision Surfaces

Lesson 1 > Extruding polygon faces

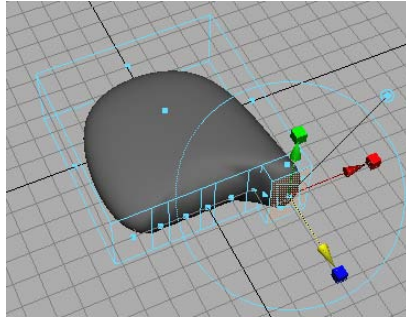

- 5 Repeat the prior two steps to create the middle segment of the smallest finger.
- 6 Repeat the prior two steps once again to create the top segment and complete the finger.

By creating three segments for a finger, you mimic a real finger's natural structure. The borders between the segments have vertices (not displayed currently) that let you reshape those regions, for instance, to create knuckles.

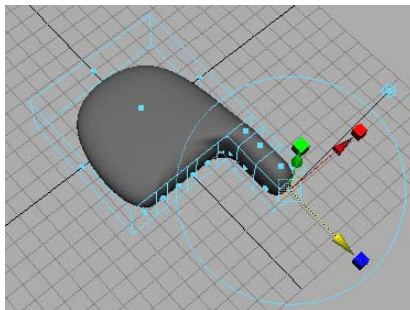

- 7 Similarly, extrude the ring, middle, and index fingers from the appropriate wide faces. Don't extrude the three small faces that lie between the wide spaces. Leave them in position to allow for webbing between the fingers.

5 | Subdivision Surfaces

Lesson 1 > Extruding polygon faces

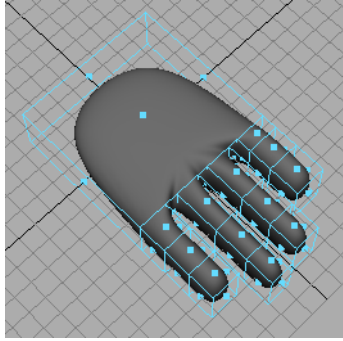

Note Do not be concerned if the hand you create does not match the lesson's illustrations. Your goal in this lesson is to learn the workflow of subdivision surfaces, not to perfect your modeling technique.

Next, you extrude a thumb using similar techniques as you used for the fingers. The following steps are abbreviated. See the preceding pages for details on the described tools, if necessary.

To split and extrude a face for the thumb

- 1** Select LeftHand.
Make sure it is highlighted in green in the scene view. If it is not green, select LeftHand in the Outliner.
- 2** Use Edit Polygons > Split Polygon Tool to split the side face in the thumb region into three faces.
While splitting, make sure the middle face is larger than the outer faces as shown below.

5 | Subdivision Surfaces

Lesson 1 > Extruding polygon faces

This face must be larger than the faces on each of its sides.

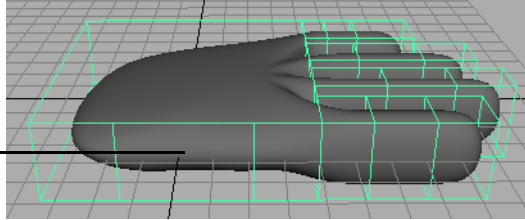

- 3 Extrude the middle face and drag it directly outward.
- 4 Click the surrounding blue circle and use the rotate manipulator to aim it in a direction appropriate for a thumb.

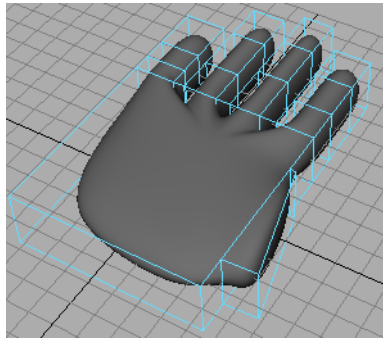

- 5 Extrude three times more to create each segment of the thumb. Use the extrusion manipulator to rotate, move, and scale each extrusion to create the desired shape of a thumb. Use the following figure as a guideline. Again, it's unnecessary to match the illustration or create a realistic thumb for this lesson.

The extrusion manipulator is easy to figure out by clicking and dragging its various elements. If necessary, you can also use the conventional Move, Scale, and Rotate Tools to reshape the faces that control the thumb's shape.

5 | Subdivision Surfaces

Lesson 1 > Extruding polygon faces

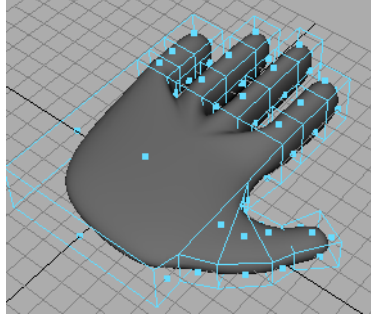

- 6** In the scene view, right-click LeftHand and select Vertex from the marking menu. The purple vertices at the corners of the faces control the adjacent region of the hand.

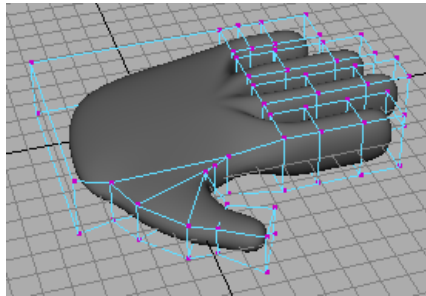

- 7** Make coarse adjustments to various parts of the hand by repositioning the vertices with the Move, Scale, and Rotate Tools.
- The Move Tool works on individual vertices or groups of vertices. Rotate and Scale works on two or more vertices. Undo any changes you don't like using Ctrl-Z (Windows and Linux) or Control-z (Mac OS X).

5 | Subdivision Surfaces

Lesson 1 > Deleting polygon faces

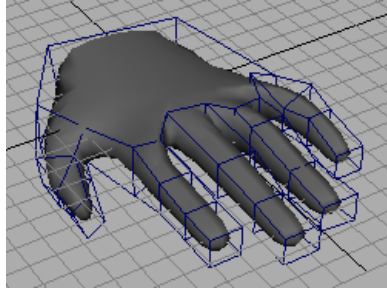

Try to create the approximate thickness, length, and curvature of a cartoon character's hand and fingers. There's no need for perfection. You'll refine the fingers later. An example hand follows. (You might be satisfied with a simpler shape.)

Deleting polygon faces

In the next steps, you delete a face in order to create a hole in the wrist where you might choose to attach an arm. Though you won't create and attach an arm in this lesson, it's useful to learn the technique for future use.

To create a hole at the wrist by deleting a face

- 1 Select the face at the wrist and press Delete to create a hole where you could attach an arm.

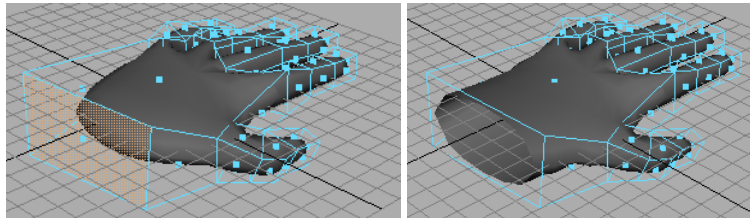

- 2 Scale the four vertices that surround the hole and scale them inward to narrow the wrist region of the hand.

5 | Subdivision Surfaces

Lesson 1 > Subdivision surface levels

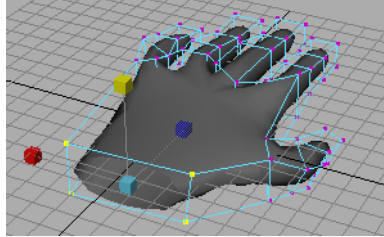

Subdivision surface levels

Next, you refine the shape of the fingers by working in Standard Mode. In Standard Mode, you can make edits to mesh vertices, edges, or faces at different levels of refinement, that are not possible in Polygon Proxy mode. The different levels of refinement are referred to as *subdivision surface levels*.

To refine the fingers using subdivision surface levels

- 1** Select LeftHand.
- 2** Select Subdiv Surfaces > Standard Mode. This switches to a mode that lets you modify the surface at various levels of detail to suit your needs.
- 3** In the scene view, right-click LeftHand and select Vertex from the marking menu.

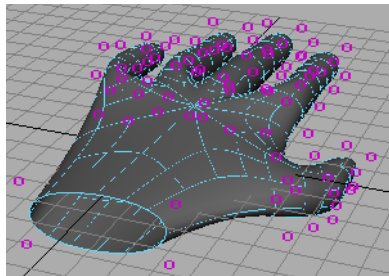

This displays Os on the surface in the same positions as the vertices in Polygon Proxy mode. In fact, the Os are vertices.

5 | Subdivision Surfaces

Lesson 1 > Subdivision surface levels

The number 0 refers to the level of detail you are capable of editing. The 0 level is identical to the coarse control possible in Polygon Proxy mode by manipulating the vertices. You can move, rotate, and scale the 0s to alter the shape of the surface just as you did for vertices in Polygon Proxy mode.

- 4 Right-click the surface and select Display Level > 1.

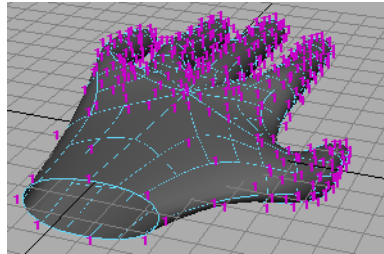

Though the 1s are displayed in the same regions as the 0s were previously, there are many more 1s displayed. The 1s are also vertices, and their increased presence means you can refine the shape with more subtlety.

- 5 Refine the shape of the fingers, thumb, and hand as desired by selecting various level 1 vertices and moving, scaling, and rotating them with the transformation tools. (Scaling and rotating has effect only if you select two or more vertices.)

It's essential to tumble the camera from various perspectives to make sure you've selected only the desired vertices.

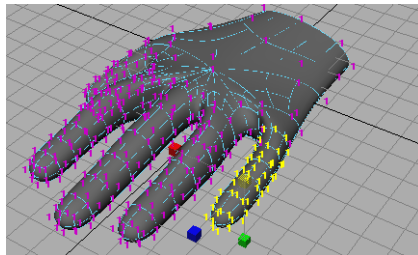

To return to level 0 to alter the shape with fewer vertices, right-click the surface and select Display Level > 0. Each level has advantages. Level 1 allows finer control because there are more vertices. Level 0 allows control of

5 | Subdivision Surfaces

Lesson 1 > Refining surface components

broader regions, and it's often easier to select the desired vertices since there are fewer of them. It's common to switch back and forth between levels repeatedly in a work session.

The hand has level 2 vertices at various locations, for instance, at the webbing between the fingers. You can also work at that level of detail if desired (select Display Level > 2).

Refining surface components

By default, a subdivision surface displays up to three levels of detail (0, 1, and possibly 2). The 0 level is the least refined. You can increase the level of detail for a selected region to at most 13 levels. Though increasing the number of levels allows more precision, it also slows Maya processing. You'll accomplish most of your modeling needs at levels 0, 1, and 2.

If you display level 2 vertices on the hand, you'll notice that there are no level 2 vertices near the fingertips. To create the indentation of a finger nail, you need more vertices than levels 0 and 1 provide. In the next steps, you'll add level 2 vertices at a fingertip so you can create a fingernail.

To create more precision in the fingernail region

- 1 Switch to level 1.
- 2 Right-click the surface and select Edge from the marking menu.
- 3 Shift-click to select the edges that surround the region where you'll shape a nail.

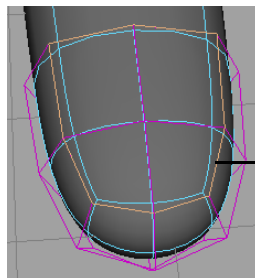

Shift-select the edges that surround the fingernail region

5 | Subdivision Surfaces

Lesson 1 > Refining surface components

- 4 To increase the amount of detail at the selected edges, select Subdiv Surfaces > Refine Selected Components. Additional surface curves appear in the fingernail area, indicating you can edit with more precision.

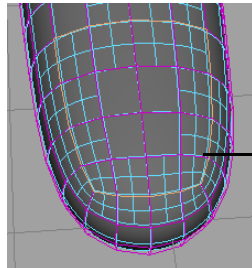

Additional curves appear to allow for more precise editing

- 5 In the scene view, right-click LeftHand and select Vertex from the marking menu. This displays additional level 2 vertices in the fingertip region.
- 6 Select Modify > Transformation Tools > Move Tool > . In the Tool Settings window, turn on Normal, then close the window. You can thereafter use the Move Tool manipulator to move vertices in a direction normal (perpendicular) to the surface.
- 7 Select the vertices in the nail region.

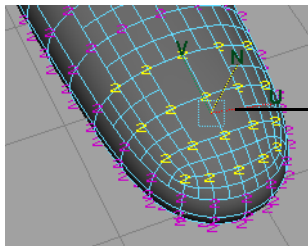

Selected vertices

- 8 Drag the Move Tool's N manipulator down slightly to form the depression of a fingernail bed.

5 | Subdivision Surfaces

Lesson 1 > Creating a crease in a subdivision surface

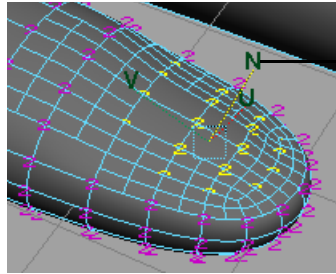

Drag the N manipulator downward to create the depression of a nail bed

Creating a crease in a subdivision surface

One of the unique features of subdivision surfaces is that it's easy to create a crease or ridge on a smooth surface. You'll do this in the next steps.

To crease the edge of the fingernail

- 1 Switch to Edge selection mode and shift-click the edges around the nail to select them. (It might be easier to see the desired edges by first selecting Shading > Wireframe.)

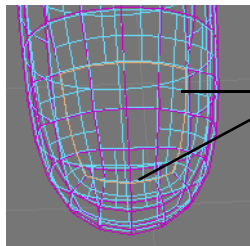

Selected edges

- 2 After you select the edges, select Subdiv Surfaces > Full Crease Edge/Vertex. Once you crease an edge, it displays with a dashed line as a visual reminder that the edge has been creased. If you change your mind, you can remove the crease using Subdiv Surfaces > Uncrease Edge/Vertex.
- 3 To create a ridge at the edge of the nail, switch to Vertex selection mode and select the level 2 vertices on the skin at the perimeter of the previously selected edges. Move them up so that the skin's juncture with the nail forms a slight ridge.

5 | Subdivision Surfaces

Lesson 1 > Creating a crease in a subdivision surface

- 4 Now experiment on your own by moving individual vertices to shape the nail and surrounding region as desired. A few suggestions follow:
 - In Smooth Shade display mode (Shading > Smooth Shade All), certain vertices might be below the shaded surface and therefore impossible to select and move. To display and select such vertices, switch to wireframe shading (Shading > Wireframe). After selecting the vertices, return to Smooth Shade display mode so you will be able to more easily see the results of moving them.
 - You might get better results using the Move Tool's default World setting rather than the Normal setting made in a prior step. To return to the default setting, select Modify > Transformation Tools > Move Tool > . In the Tool Settings window, click Reset Tool, and then close the window.
 - To extend the front of the nail past the skin with a sharp edge, add a second crease on the edges below the tip of the nail. (With the appropriate edges selected, select Subdiv Surfaces > Full Crease Edge/Vertex.)

You might also want to add an additional level of vertices at the edges. (With the appropriate vertices selected, select Subdiv Surfaces > Refine Selected Components.)

After you crease the edges and add the extra vertices, you can make the nail's edge overhang the skin below it by dragging the vertices at the nail tip out and away from the finger. Then tuck the row of vertices below the overhanging vertices in the opposite direction.

An example of a completed nail follows:

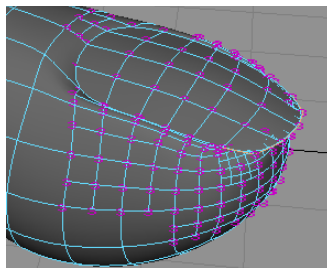

Completed fingernail

- 5 If you want more practice, repeat the procedure for the rest of the nails.

5 | Subdivision Surfaces

Lesson 1 > Beyond the lesson

- 6 When finished, select Modify > Transformation Tools > Move Tool > . In the Tool Settings window, click Reset Tool, and then close the window. This returns the Move Tool to its default settings. This will avoid confusion if you do other lessons in this book.

Beyond the lesson

In this lesson, you were introduced to some basic techniques related to subdivision surface modeling:

- Modeling with subdivision surfaces is an easy way to create intricate, smooth objects such as human hands and faces. The ability to create extrusions, subtle surface alterations, and sharp edges means there are innumerable types of objects you can model.
- Many of the techniques used in modeling polygonal surfaces are applicable to subdivision surfaces.

There are many other features related to subdivision surfaces not covered in this lesson. These include the ability to:

- Convert a NURBS surface to subdivision surface.
- Convert a subdivision surface to a polygonal or NURBS surface.
- Create subdivision surface primitive shapes from the Create > Subdiv Primitives menu: Sphere, Cube, Cylinder, Cone, Plane, and Torus. With these shapes, you can quickly start your subdivision surface model without converting from polygons or NURBS surfaces.
- Attach two subdivision surfaces to form a single surface, for instance, to merge a hand and an arm.
- Create a mirrored copy of a subdivision surface.
- You can sculpt subdivision surfaces using the Sculpt Geometry Tool.

If you want to learn more about a particular tool or feature that has been presented in this lesson, refer to the Maya Help.

6 Animation

Maya lets you apply action to the objects in your 3D scene. In Maya, when an object or attribute changes in relation to time, it is referred to as being animated.

Maya provides a large selection of tools to help you animate the objects in your scene. You may decide to use a combination of several techniques to achieve your desired results.

In this chapter, you learn some common techniques and features that highlight Maya's computer animation technology:

- “Lesson 1 Keyframes and the Graph Editor” on page 166
- “Lesson 2 Set Driven Key” on page 183
- “Lesson 3 Path animation” on page 189
- “Lesson 4 Nonlinear animation with Trax” on page 210
- “Lesson 5 Inverse kinematics” on page 250

Preparing for the lessons

To ensure the lessons work as described, do these steps before beginning:

- 1** Select Window > Settings/Preferences > Preferences. Click the Settings category and set the Time option to Film (24 fps) so your animation plays at the rate of 24 frames per second. Click the Save button.
- 2** Select the Animation menu set. Unless otherwise noted, the directions in this chapter for making menu selections assume you've already selected the Animation menu set.

6 | Animation

Lesson 1 > Preparing for the lessons

Lesson 1 Keyframes and the Graph Editor

When you set a keyframe (or *key*), you assign a value to an object's attribute (for example, translate, rotate, scale, color, etc.) at a specific time.

Most animation systems use the *frame* as the basic unit of measurement because each frame is played back in rapid succession to provide the illusion of motion.

The frame rate (frames per second) that is used to play back an animation is based on the medium that the animation will be played back (for example, film, TV, video game, etc.)

When you set several keys at different times with different values, Maya generates the attribute values between those times as the scene plays back each frame. The result is the movement or change over time of those objects and attributes.

In this lesson, you will use simple keyframing techniques to make a ball fly over a fence and bounce off the ground.

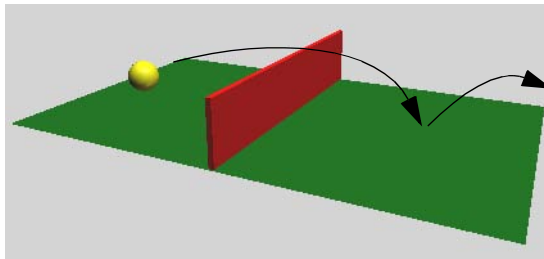

In this lesson, you learn how to:

- Set keyframes for animatable objects and their attributes.
- Use the Time and Range slider and Playback Controls to control the playback.
- Use keyboard shortcuts to set keyframes.
- Use the Graph Editor to view animation curves.
- Modify the animation of objects using the Graph Editor.
- Set preferences to increase the playback quality.

Getting Started with Maya

Setting the playback range

In this lesson, you work with a scene we've created for your use. In the following steps, you open the scene and set how long the animation will play.

To open the scene

- 1 Make sure you've done the steps in "Preparing for the lessons" on page 165.
- 2 Open the scene named `Keyframing.mb`.

You can open the scene named `Keyframing.mb` from the *Maya Documentation, Lessons, and Extras* CD or from the drive where you copied the Getting Started with Maya data files.

The scene contains a ball object that is currently positioned on the X-axis near the edge of a ground plane.

To set the playback range for the scene

To animate the ball, you key its position at different times of the playback range.

The playback range is defined by the Time and Range slider. The Time and Range slider controls allow you to playback or scroll through your animation or move to a specific point in time of your animation so you can set keyframes.

- 1 Look over the playback controls, as shown in the figure below:

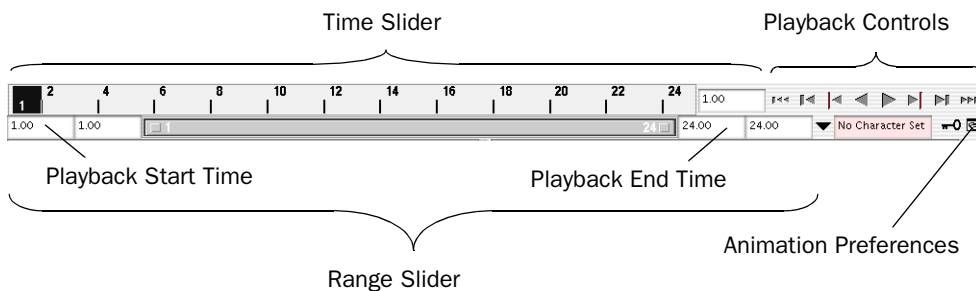

6 | Animation

Lesson 1 > Setting keyframes

The Time Slider displays the playback range and keys you've set for a selected object. Keys are displayed as red lines. The box at the right of the Time Slider lets you set the current frame (time) of the animation.

The Playback Controls control animation playback. You may recognize the conventional buttons for play and rewind (return to the start time). The stop button appears only when the animation is playing. To find out which operation a button represents, hold the mouse pointer over it.

The Animation Preferences button displays a window for setting animation preference settings such as the playback speed.

The Range Slider controls the range of frames that play when you click the play button.

The above items will have more relevance as you work through this lesson. After you complete this lesson, experiment with these items to learn more what they do.

The playback range is currently set at a range of 1 to 24. At a default playback rate of 24 frames per second, the scene can play for one second. Because you'll animate the ball for a few more seconds than this, you need to lengthen the playback range.

- 2 In the Playback End Time box (see above), enter 72.

A frame rate of 24 frames per second (fps) is the frame rate used for motion picture film. For video, the frame rate can be 30 fps (NTSC) or 25 fps (PAL) depending on the format being used.

With a playback range of 1 to 72, you'll be able to create three seconds of animation. (72 frames divided by 24 frames per second = 3 seconds.) This is enough time for the short animation you'll create in this lesson.

Setting keyframes

In the following steps, you use keyframes to set the starting and ending positions of the ball's movement.

To set beginning and ending keyframes

- 1 Click the rewind button to go to the start of the playback range. This changes the current frame to 1.

- 2** Select the ball, then select **Animate > Set Key**. (Keyboard shortcut: **s**).
This sets a key at frame 1 for all *transform attributes* of the ball. Transform attributes are the X, Y, Z move attributes. Although you animate only the translate X and Y attributes of the ball in this lesson, keying all transform attributes saves you time having to choose specific attributes to be keyed.
In the Time Slider, notice the red marker at frame 1, known as a tick. This tick appeared when you set the key for frame 1. With the ball selected, ticks in the Time Slider indicate where you've set keys.
- 3** Go to frame 72. A convenient way to do this is to click the desired position in the Time Slider.
- 4** With the Move Tool, drag the ball's X-axis handle to position the ball at the right edge of the ground as shown in the image below.

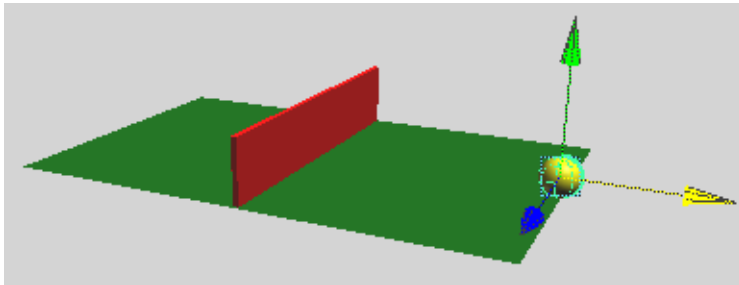

- 5** Set a key at frame 72. (Press **s**.)
- 6** Go to the start time and play the animation.
From the two keys you've set, Maya creates motion between the positions. By default, the animation plays in a loop from frame 1 to 72. The ball travels through the fence at this stage.
- 7** Press the Stop button on the playback control to stop the animation after you view a few repetitions.
You can drag the mouse back and forth (scrub) in the Time Slider to see the animation play back and forth at the speed you drag the mouse.
If you were to display the scene with **Panels > Layouts > Four Panes**, only the active panel would show the ball moving.

6 | Animation

Lesson 1 > Setting keyframes

To make the ball fly over the fence rather than pass through it, you need to position the ball above the fence and set a key there.

To set intermediate keyframes

- 1 Go to frame 33 or so—at the moment where the ball sits in the middle of the fence.
- 2 With the Move tool, drag the Y-axis handle of the ball until it sits slightly above the fence.

Tip Throughout this lesson, tumble the perspective view or examine a front view to make sure the positioning is correct.

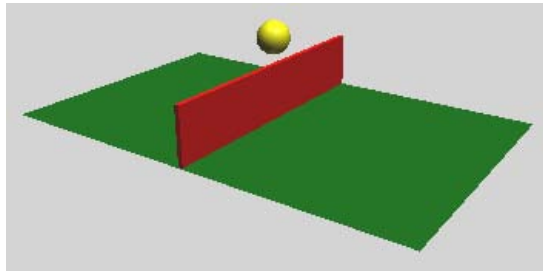

- 3 Set a key. (Press s.)
- 4 Play the animation.
The ball now flies off the ground, over the fence, and back to the ground in a smooth arc between the keyed start, middle, and end positions.
- 5 Press the stop button to end the playback.
In subsequent steps, play the animation after each key you set. It's generally useful to check your work in progress after each key, especially when you are learning.

In the next steps, you'll set keys to bounce the ball in the middle of the right half of the ground.

To set keyframes to make the ball bounce

- 1** Go to frame 50. At this moment, the ball sits in a position above the middle section of the right half of the ground.
- 2** Move the ball so it sits on the ground.

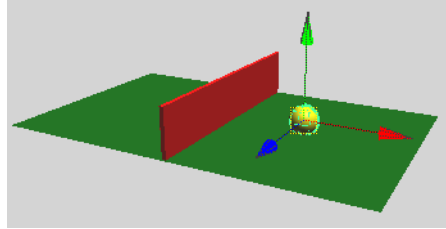

- 3** Set a key.
- 4** Go to frame 60.
- 5** Move the ball up again, but not as high as its peak height above the fence.

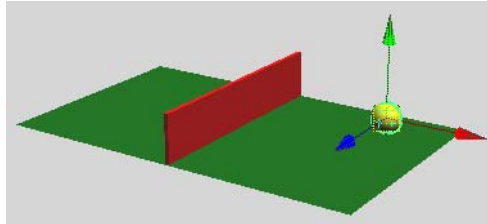

- 6** Set a key. When you play the animation, the ball travels over the fence and bounces on the other side.

If you have a fast computer, you might notice that the animation plays too fast. By default, Maya plays the animation as fast as it can be processed. Because this scene is simple, the animation might play faster than the default film rate (24 frames per second).

Do not be concerned that the animation plays with a halting or jerky motion. When you render all the frames of your animation for final production, the animation will be smooth. If you want to preview the animation at the smooth production speed (or nearly so), use Window > Playblast.

6 | Animation

Lesson 1 > Using the Graph Editor

Using the Graph Editor

For a more convincing animation, you need to bounce the ball more sharply off the ground and speed up the ball's horizontal movement. You'll use the *Graph Editor* to make both modifications.

The Graph Editor is an editor that graphically represents the various animated attributes in your scene. The animated attributes are represented by curves called *animation curves*. You edit animation curves in the Graph Editor.

To edit animation curves using the Graph Editor

- 1 With the ball selected, select Window > Animation Editors > Graph Editor.

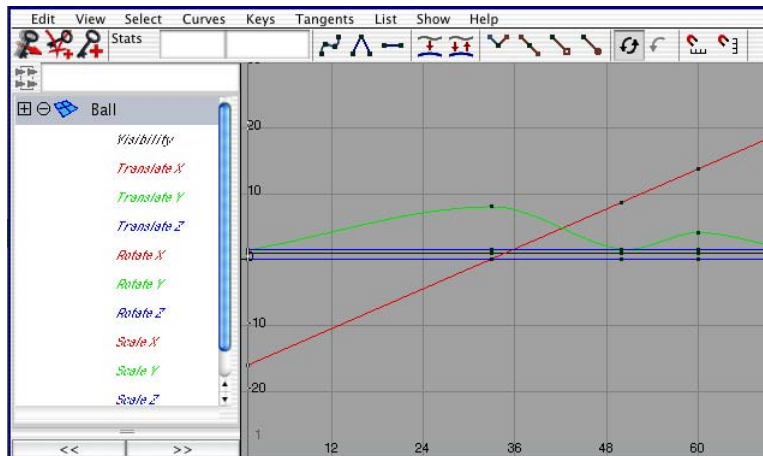

The Graph Editor displays several *animation curves*, one for each keyed attribute of the ball. The animatable attributes for the ball are listed in the left column. Specifically, it displays the attributes of the selected transform node of the ball.

Each curve graphs how an attribute changes value during the animation. The column of numbers at the left represents attribute values that can be animated, while the row of numbers at the bottom represents time (frame)

values. At each point on the curve, you can see the value of an attribute at a particular time. The small black squares on the curves represent points where you've set keys.

- 2 Shift-Select only the Translate X and Translate Y attributes in the left column of the Graph Editor.

Now only the animation curves for Translate X and Translate Y appear in the Graph Editor.

This simplifies the display. With too many curves present, it's hard to see specific curves. When you use the Graph Editor, you usually focus on one or a few curves.

- 3 To center the display of the animation curves, select View > Frame Selection (in the Graph Editor window). If you want to see more detail in the graph, use your mouse to dolly and track the graph view.

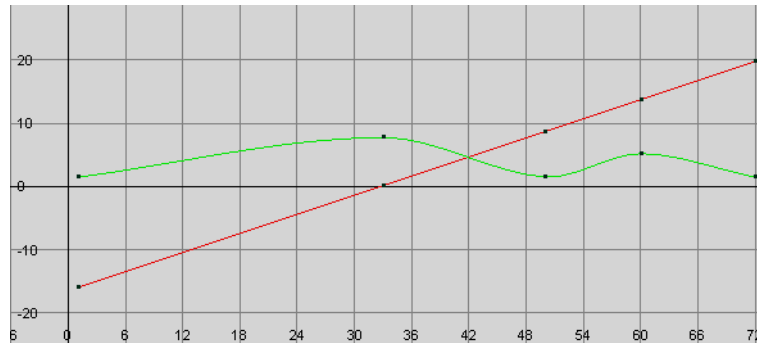

The green curve represents Translate Y, while the red represents Translate X. The color of each curve matches its attribute name. This color scheme is consistent throughout Maya for X, Y, and Z (red, green, blue) so is easy to remember.

If you've never used a graph editor before, the relationship between a curve's shape and the animation it represents might be hard to understand. With experience, you'll quickly recognize how curve shape affects animation.

In the above graph, the straight curve of Translate X indicates that the ball moves horizontally across the ground at a constant rate over time.

6 | Animation

Lesson 1 > Using the Graph Editor

The wavy curve of Translate Y indicates that the ball increases its height steadily until frame 33, dips more quickly until frame 50, then rises and dips again until frame 72.

When the ball first bounces off the ground at frame 50, it seems to float and slip rather than rebound. The shape of the Translate Y curve illustrates why. Near frame 60, the curve is soft and rounded. The Translate Y values gradually decrease to the low point then gradually increase. The transition from decreasing to increasing values is smooth.

The Graph Editor's usefulness lies in the fact that you can edit the shape of the animation curves to edit the animation of any keyed attribute. To create a sharp bounce, you can edit the curve so that the transition from decreasing to increasing values is abrupt at frame 50. Specifically, you'll create a corner at that key point rather than a rounded curve.

- 4 Select the point on the Translate Y (green) curve at frame 50. This causes a pair of tangent handles to appear at the point. Each end point of the newly displayed straight line is a tangent handle. The handles let you control the curvature near the key point.

Animation curves have a few control structures for curve editing. You can do any of these operations:

- Use the Move tool and middle mouse button to move a key point. You can alternatively use your keyboard to enter precise values for a selected key's frame and value in the boxes above the graph area.
- Use the Move tool and middle mouse button to drag the tangent handles and change the adjacent curvature.

(You can shift-drag with the Move tool to constrain a move operation to a single direction.)

- Use the Scale tool and middle mouse button to scale selected key points closer together or further apart.
 - Use the Graph Editor's Tangent menu items to change the adjacent curvature. This is the operation you'll use in the next step.
- 5 In the Graph Editor, select Tangents > Linear.

This changes the curvature around the key point from rounded to cornered. Specifically, the setting you select specifies how the key point tangent handles lie at this key point. This affects the type of interpolation between key points.

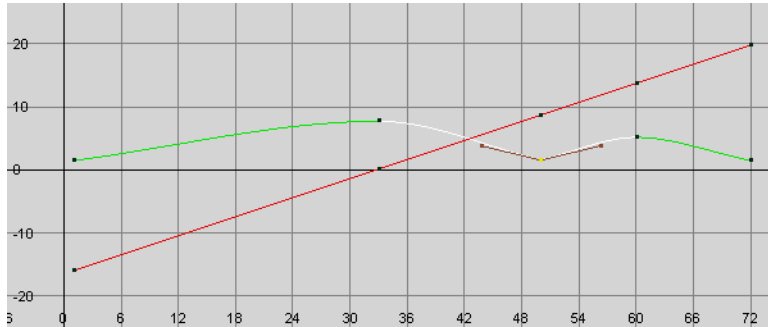

- 6** Play the animation and you'll see the ball bounce more sharply.
To sharpen the bounce more, you need to edit the positioning of the tangent handles to steepen the curvature approaching the key point.
- 7** Select one of the tangent handles.
- 8** Use the Move Tool and the middle mouse button to drag it upwards a little so you can see the how the curvature at the key point changes.
By default, when a pair of tangent handles share a key point, they work as a unit. Move one and you move the other in an opposing direction. This is often desirable in an animation curve, because it ensures the curvature at that point stays symmetrical. Symmetrical curvature often helps prevent unusual animation shifts.
In this case, however, you want to steepen the curvature's approach toward the curve point in the same direction on both sides. You therefore need to break the symmetrical interdependency between the two tangents.
- 9** Undo your previous move of the tangent handle.
- 10** Select the key point at frame 50 (not a tangent handle).
- 11** In the Graph Editor, select Keys > Break Tangents.
This lets you move each tangent handle independently.

6 | Animation

Lesson 1 > Changing the timing of an attribute

- 12 Select the right tangent handle and use the Move Tool to move it up a little. Do the same for the left tangent handle. Be careful not to select the key point.

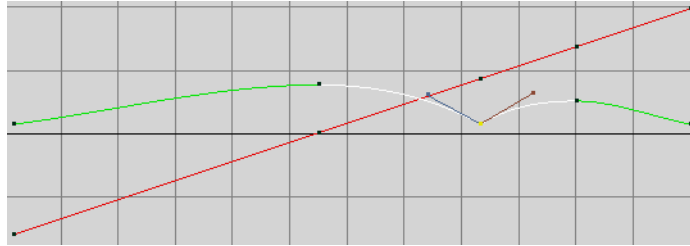

This sharpens the bounce to simulate the effect of gravity and elasticity.

Changing the timing of an attribute

The ball seems to move too slowly in its journey. In the following steps, you'll use the Graph Editor to hasten its movement. Specifically, you'll cause the ball's animation to finish its journey in two seconds (48 frames) rather than three (72 frames).

To speed up the animation of the ball's movement

- 1 Drag a selection box around all key points of both curves.
- 2 Select the Scale tool.
- 3 Click and hold the middle mouse button anywhere in the graph at frame 1 (slightly to the right of 0).

Notice the question mark icon. The location of this icon indicates the point from which scaling occurs. (Because you need to scale the animation inward toward frame 1, you need to start your drag operation at frame 1.)

- 4 Without releasing the mouse button, drag to the left until the right-most key points on both curves are positioned roughly at frame 48. (When selected, the right-most key points are yellow.)

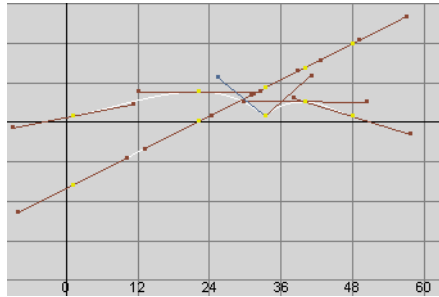

This scales the curves symmetrically towards frame 1. The animation of the ball now plays from frame 1 to 48 rather than 1 to 72. The ball traverses the scene in less time, which, of course, means it moves faster.

If you had started your drag operation from the middle of the frame range, the scale operation would have pulled the curves toward the middle of the frame range. You can snap the keypoints to whole values to keep the keyframes on a consistent timing.

- 5 Widen the Graph Editor window as necessary to see the graph clearly. Also, dolly the view or select View > Frame Selection (in the Graph Editor window).

Fine tuning an animation

Now you can improvise adjustments to the animation on your own. For example, you might choose to speed the ball's horizontal movement up to the first bounce but not thereafter. You might also decide to raise the peak height of the ball's motion so that it doesn't seem to hover over the fence unrealistically.

Whatever you choose to do, you'll likely need to edit both the Translate X and Translate Y curves, not just one of them. Play the animation after each adjustment.

The following two figures show examples of curves after modification. The two graphs are identical, except the curve points are selected in the second figure. The second graph shows the position of the tangent handles.

6 | Animation

Lesson 1 > Fine tuning an animation

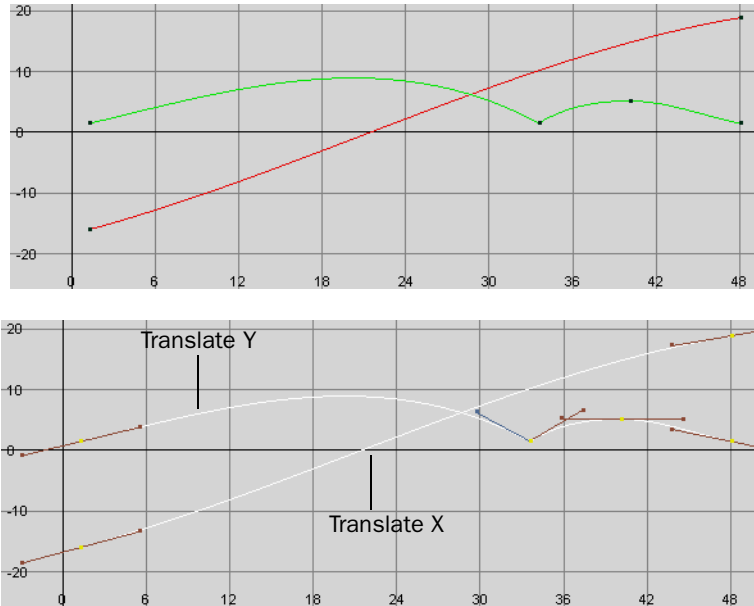

If you want your curves to match the shape of the curves in the above figure, here's what you would need to do:

To adjust the animation curves to match the above images

- 1** On the Translate X curve, delete the three key points between the two key points at the end. (The preceding figures show the curve after the points were deleted.) To delete the points, drag a selection box around them and press Delete.

With fewer key points on the curve, it's easier to maintain the curve's smoothness for larger distances as you edit its shape. Small kinks in an animation curve can ruin an otherwise perfect animation, so it's useful to remove key points that you aren't using.

- 2** On the Translate X curve, select the left-most key point and move its right tangent handle down slightly. (Remember to use the middle mouse button when moving a handle or point.) Select the right-most key point and move its left tangent handle up slightly.

Notice that the slope of the Translate X curve increases slightly in the early part of the animation, then tapers off toward the end. This causes the ball to accelerate slightly at the beginning of the animation, then decelerate after its first bounce.

- 3** On the Translate Y curve, remove the key point at frame 22. (The preceding figures show the curve after the point was removed.) This point wasn't essential to the curve shape.
- 4** On the Translate Y curve, select the left-most key point and move its right tangent handle up slightly.
- 5** At the key point where the bounce occurs on the Translate Y curve, move the left tangent handle up a bit. This raises the high part of the curve left of that key point, which makes the ball rise higher over the fence.
- 6** If you want to change the shape of Translate Y curve but lack adequate control with the existing key points, you can add a key point at the position of your choice. (No key points were added in the prior figures.) To add a key, click the Add Keys Tool icon, select the curve, and middle-click the desired position on or off the curve.

Add Keys Tool



Deleting extra keyframes and static channels

As you set keys, you often create many unintended keys. For example, when you used the Set Key operation on the ball, Maya created keys on all transform node attributes of the ball, for instance Rotate Z, not just the intended Translate X and Translate Y attributes. The curves representing such attributes have unchanging values. The attributes are known as *static channels*.

You can identify static channels by examining animation curves in the Graph Editor. If a curve is horizontally flat its whole length, the value of the attribute it represents isn't changing. The attribute is a static channel. Static channels slow Maya processing, so it's beneficial to remove them in complex scenes.

To delete static channels

- 1** From the main menu, select Edit > Delete All by Type > Static Channels.

6 | Animation

Lesson 1 > Using Playblast to playback an animation

This deletes all unnecessary keys for all objects in the scene. Alternatively, you can remove the static channels for a selected object with Edit > Delete by Type > Static Channels.

In addition to static channels, you'll often create excess keys—keys that aren't being used to control the shape of a curve. Whenever you see three key points that lie in a straight line, the one in the middle is unnecessary. For example, in this lesson's original Translate X curve, there were four redundant keys:

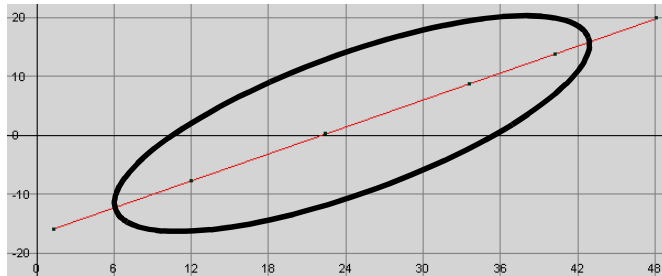

To delete keys, select the key points and press Delete. When you remove redundant key points, the shape of the curve doesn't change and you speed up Maya processing.

Using Playblast to playback an animation

When you play a scene, you see a rough approximation of the animation. The playback speed and quality is imprecise as compared to rendering each frame and playing the frames in sequence with a playback utility specifically designed for this purpose. The reason for this is that Maya processes the animation of each frame before display, while a playback utility simply plays previously processed and rendered images.

The more detail that Maya needs to process, the slower the playback. For example, playback will likely be slow for any scene that has several complex objects displayed with Smooth Shade All and Hardware Texturing.

To preview the animation with more accurate timing

- 1 Select Window > Playblast.

For the next several seconds, Maya processes the entire animation frame by frame. When the process is complete, a playback window appears.

- 2** Click the play button in this window to watch the animation.
- 3** Close the Playblast window when you're done.

Beyond the lesson

In this lesson, you learned how to:

- Set keys for attributes, then use the Graph Editor to refine the animation and remove unnecessary keys. This is a typical workflow when keyframing.

You can animate most any attribute in Maya, not just the Translate, Rotate, and Scale attributes of a surface. For example, you can animate the intensity of a light, the transparency of a surface, the rotation of a camera view, or the position of CVs.

- Work with the Graph Editor to adjust the animation attributes animation curves directly.

The Graph Editor is the best tool for editing keyed animation by reshaping animation curves. You can use it to change key positions, add or remove keys, and alter the fluidity and symmetry of animation.

Each key point on an animation curve has a Tangent setting that specifies the curvature leading into that point. The default Tangent setting (Spline) creates rounded curvature—useful for animating attributes that change smoothly over time. The Linear setting creates angular curvature, useful for a bounce effect or any other abrupt change in attribute value. Other Tangent settings are available for different animation effects. For example, a Stepped setting lets you make an instantaneous leap in value, useful when you want to flash a light off and on.

- Use the Time and Range slider to play back your animation.

Although the Graph Editor is a popular animation tool, you can also cut, copy, paste, and delete keys directly in the Time Slider to edit animation. Select a key position in the Time Slider, then right-click to select the desired operation from a pop-up menu.

You may find the following techniques useful when keyframing your animations:

6 | Animation

Lesson 1 > Beyond the lesson

- There are alternative object display modes that quicken the display of animation in the scene view. When you select Shading > Bounding Box (from the panel menu in the scene view), Maya displays simple box-shaped geometry in place of the actual objects in your scene. The simpler shapes enables Maya to respond to any camera and object movement faster. The drawback is that you cannot edit the shape of the objects in this display mode.
- It is generally a recommended practice to animate a parent (group) node rather than objects themselves. By animating a parent node, you can avoid problems that occur when the animation of one object in a hierarchy conflicts with the animation in another part of the hierarchy.

Lesson 2 Set Driven Key

With keyframe animation, you key an attribute value to a time in the Time Slider. You repeat this process with different values at different times to animate the object.

When you must animate multiple objects or attributes that interrelate, setting keyframes can quickly become a complex task. *Set Driven Key* is a technique for driving one object's or attribute's animation from another attribute.

With *driven keys*, you relate an attribute value to the value of another attribute. You repeat this with different values to create a dependent link between a pair of attributes. A change in the *driver* attribute alters the value of the *driven* attribute. In this way the animation of the driven attribute doesn't need to be manually set; it occurs automatically once the relationship between attributes has been established. This makes setting up some types of animations much more efficient. For example, you can use driven keys to make a door open when a character walks in front of it.

In this lesson, you will learn how to use Set Driven Key in order to animate a door rising upwards when a ball approaches it.

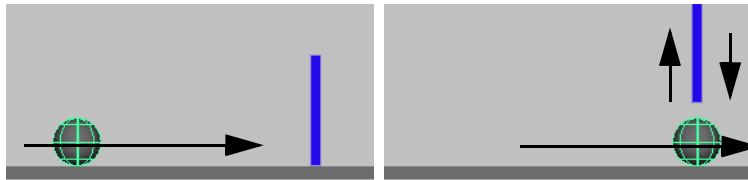

In this lesson you learn how to:

- Link the object attribute behavior between two objects which will link the movement of one keyframed object to another with no keyframes assigned.
- Use the Graph Editor to adjust the animation for the driven object.

6 | Animation

Lesson 2 > Lesson setup

Lesson setup

In the following steps, you set a playback range that's long enough to see the animation clearly. You also create the ball and the door, and position them in the scene view in preparation for the animation.

- 1** Make sure you've done the steps in "Preparing for the lessons" on page 165.
- 2** Create a new scene.
- 3** Go to the start frame.
- 4** Create a polygonal cube and name it `Door`.
- 5** Scale and position it roughly as shown in the previous figure. Have the bottom edge of the door lie roughly along the X-axis.
- 6** With the pointer in the perspective view, press 5 (for Shading > Smooth Shade All).
- 7** Create a small polygonal sphere and name it `Ball`. Scale and position it roughly as shown in the prior figure. Have it sit roughly at 0, 1, 10 (X, Y, Z).
Use the default color for the door and the ball.

Using Set Driven Key to link attributes

The following steps link the door's movement to the ball's movement using Set Driven Key.

To link the door's movement to the ball's movement

- 1** Select the door and choose `Animate > Set Driven Key > Set >` .
The Set Driven Key window appears with the door in the Driven list.

- 2** Click translateY in the Driven list.

This is the attribute to be driven by the ball's movement.

- 3** Select the ball in the scene view.

- 4** In the Set Driven Key window, click the Load Driver button.

The ball appears in the Driver list.

- 5** In the Set Driven Key window, click translateZ in the Driver list.

This is the attribute that will drive the door's movement.

You can set a driven key only after you select an attribute in the Driver list and in the Driven list.

- 6** In the Set Driven Key window, click Key.

This sets a driven key relationship that links the current Translate Z value of the ball to the current Translate Y value of the door. Whenever the ball's Translate Z is at this position, the door's Translate Y will be at its current position.

The Time Slider is not involved in a driven key relationship and displays no red markers for keys.

The Time Slider is not involved in a driven key relationship and displays no red markers for keys.

- 7** Move the ball to the door's position and then move the door above the ball.



6 | Animation

Lesson 2 > Using Set Driven Key to link attributes

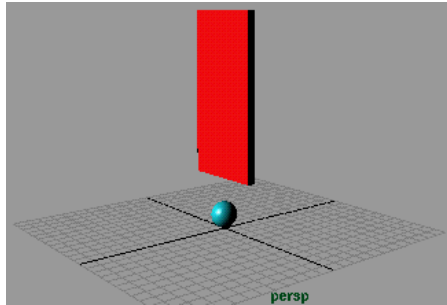

- 8** In the Set Driven Key window, click Key.
This sets another driven key that links the current Translate Z value of the ball to the Translate Y value of the door.
- 9** Move the ball to the right of the door and then lower the door to its previous position as shown in the following figure.

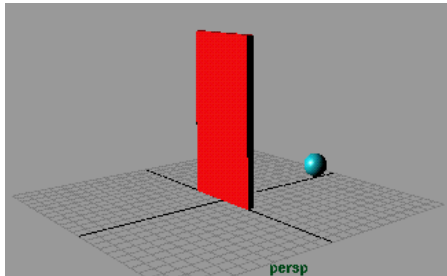

- 10** In the Set Driven Key window, click Key.
This sets another driven key that links the attributes.
You've set three driven keys that link the attribute values at different positions. Maya interpolates the linked values to generate the values between the keys.
If you drag the ball toward the door from either side, the door rises smoothly.

Playing back the animation from the Time Slider doesn't move the ball or the door. Driven keys link one attribute to another. They don't link attributes to times in the Time Slider. However, if you were to animate the movement of the ball, the door would move based on the driven key relationship that has been set.

Viewing the results in the Graph Editor

In the next steps you'll examine the animation curve resulting from the driven keys you've set. If you are unfamiliar with animation curves and the Graph Editor, see "Lesson 1 Keyframes and the Graph Editor" on page 166.

To view the set driven key results in the Graph Editor

- 1** Select the door. To display the animation curve for a driven key in the Graph Editor, you must select the object containing the *driven* attribute, not the object containing the driving attribute.
- 2** Select Window > Animation Editors > Graph Editor.
- 3** From the Graph Editor, select View > Frame All. The Graph Editor shows the driven keys that link the door's TranslateY value to the ball's Translate Z value. An example follows:

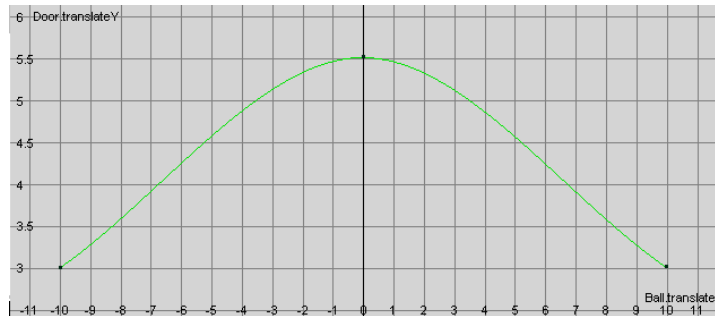

The column of numbers on the left lists the driven attribute values. The row at the bottom lists driver attribute values. The animation curve shows the relationship between the values—the door's Translate Y value rises as the ball's Translate Z value approaches 0.

6 | Animation

Lesson 2 > Beyond the lesson

You can use the Graph Editor to edit the shape of the curve to make the door rise faster, slower, and higher as the ball approaches it.

Beyond the lesson

In this lesson you learned how to:

- Set driven keys to link one attribute's values to another.

A driven attribute is not directly affected when you play the animation. It is linked to a driving attribute's value, not animation time. However, you can use regular animation keys, expressions, motion paths, or other techniques to animate the driving attributes. This indirectly animates the driven attribute.

You may find the following notes helpful when using Set Driven Key:

- You can set driven keys to control a driven attribute with multiple driving attributes. For instance, you can have a muscle bulge when an elbow rotates, and have the bulge increase when the wrist rotates.

Lesson 3 Path animation

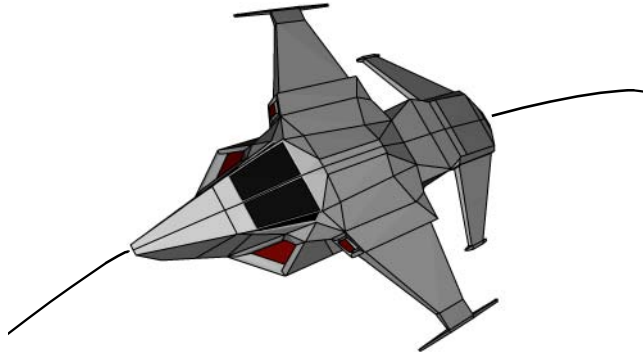

Model created by: Ted Charlton

Path animation allows you to animate an object along a path specified by a curve. In this way, the curve controls the motion of the object. With keyframe animation, Maya calculates the motion of the object for the animation based on the positions that were set at the keyframes. With path animation the motion for the object is defined by its location along the path curve.

Path animation is useful for animating objects such as trains, boats, airplanes, and moving cameras whose motion follows a set path. To animate an object to do this type of motion smoothly with keyframe animation would require you to laboriously create and edit many keys for the motion. By having the object move along a curve, you can easily adjust the object's path by editing the curve.

In this lesson, you make an aircraft follow a motion path so it appears to fly and bank while it changes trajectory. We provide a scene for your use in the lesson.

In this lesson, you learn how to:

- Set an object to animate along a motion path using a NURBS curve as the path.
- Modify the timing and rotation of an object along a motion path.
- Blend between keyframe and motion path animation.

6 | Animation

Lesson 3 > Open the scene for the lesson

Open the scene for the lesson

In this lesson, you work with a scene we created for your use.

- 1 Make sure you've done the steps in "Preparing for the lessons" on page 165.
- 2 Open the scene named `PathAnim.mb`.

You can open the scene named `PathAnim.mb` from the *Maya Documentation, Lessons, and Extras* CD or from the drive where you copied the Getting Started with Maya data files.

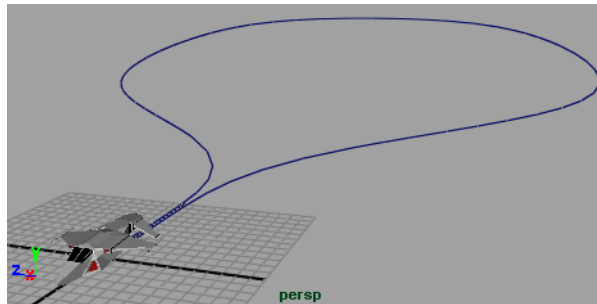

The scene contains two objects named `Aircraft` and `PathCurve`. When the aircraft travels on the path curve it loops back to where it began.

- 3 In the Time Slider, ensure that the Playback End Time is set to 240.

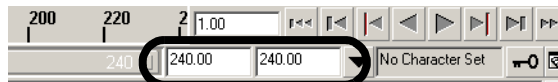

The path animation occurs between frames 60 and 240 (180 frames in total). Between frames 1 and 60, you keyframe the aircraft's motion so it rises from the ground plane. You then blend between the two animation types.

Animating an object along a motion path

To animate the aircraft along the path curve, first select the aircraft and the path curve and then set appropriate options for the motion path animation. In the options window, you need to set the required time range for the path animation.

You also need to ensure that the aircraft is oriented facing towards the direction of travel. The Follow, Front, and Up axis option settings determine the aircraft's orientation along the path.

To attach the aircraft to the motion path

- 1** Set the Time Slider to frame 1.

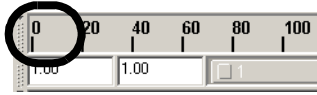

- 2** Select the aircraft and then shift-select the path curve.
- 3** In the main menu, select **Animate > Motion Paths > Attach to Motion Path >** .

The Attach to Motion Path Options window appears.

- 4** In the options window, ensure the options are set as follows, then click **Attach**.
 - Time Range: Start/End
 - Start Time: 60
 - End Time: 240
 - Follow: On
 - Front Axis: X
 - Up Axis: Y
 - World Up Type: Scene Up
 - Leave all other settings off

6 | Animation

Lesson 3 > Animating an object along a motion path

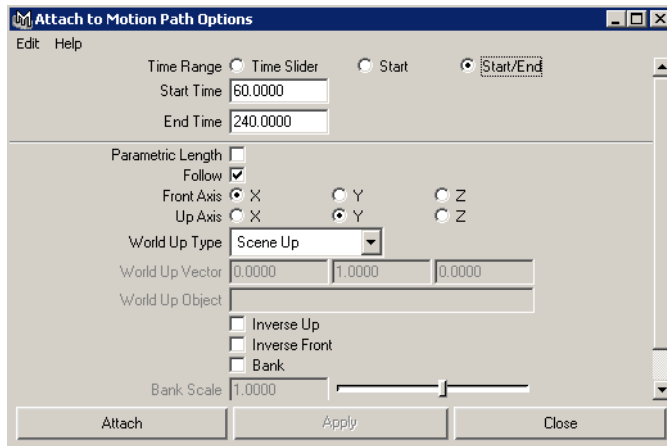

The aircraft is repositioned to the start of the curve, and oriented towards the direction of travel.

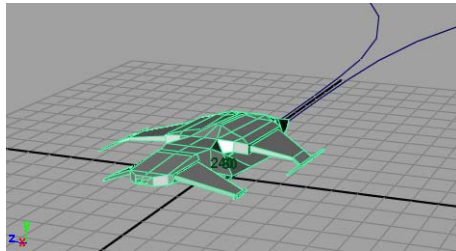

The Start and End Times set the time duration the aircraft travels along the path curve ($240 - 60 = 180$ frames). The start and end times are displayed at the ends of the curve.

- 5 Click play on the Timeslider playback controls to play back the animation. The aircraft travels along the path. Observe that it begin its motion at frame 60.

Lesson 3 > Changing the timing of an object along a motion path

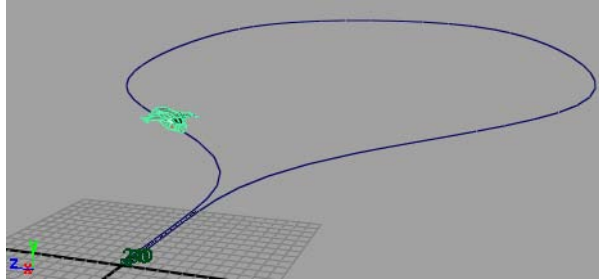

Changing the timing of an object along a motion path

When you first assign an object to a motion path, by default, the object travels along the path at a constant speed. In this lesson, you want the aircraft to initially travel along the path slowly, accelerate, and then finally move more slowly when it nears the end of the motion path.

You can change the rate of travel for the aircraft by keyframing attributes that affect where the aircraft is positioned on the curve at a given time.

To view the attributes for the motion path

- 1 Set the Time Slider to frame 1.
- 2 Select the aircraft.
- 3 Open the Channel Box by clicking the Show/Hide Channel Box icon on the Status Line.

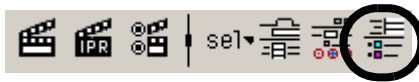

- 4 In the Channel Box, click on the word motionPath1 that appears in the Aircraft's Inputs list.

The attributes for motionPath1 appear at the bottom of the Inputs list. (Scroll the Channel Box window if the MotionPath1 attributes are not fully visible)

6 | Animation

Lesson 3 > Changing the timing of an object along a motion path

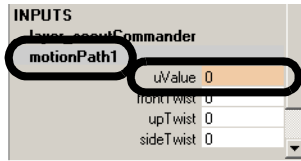

The UValue attribute controls where the aircraft gets positioned along the curve. The UValue refers to the curves *parameterization*. Parameterization is a method used by Maya to divide a curve into increments of known amounts so that a location along the curve can be determined.

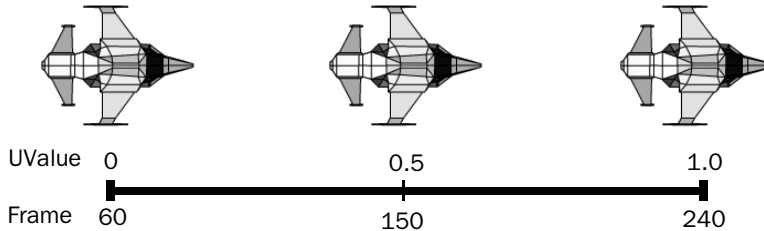

By default, the parameterization of a path curve is set between zero and one. At frame 60, the aircraft is at the beginning of the curve where the parameterization value is zero. When the aircraft is at the end of the curve (frame 240) the parameterization value for the curve is one. When the aircraft is halfway through the path animation (frame 150), it is located along the curve at a UValue of 0.5.

By setting the frame number and UValue and then setting a key, you change the timing for the aircraft's motion along the path.

To change the timing for the aircraft along the path

- 1** Ensure the aircraft is selected so its attributes display in the Channel Box.
- 2** In the Time Slider, drag the current time indicator to frame 120 using the middle mouse button.

Middle-dragging the current time indicator, instead of using the left mouse button, changes the current time without repositioning the aircraft along the path.

Lesson 3 > Changing the timing of an object along a motion path

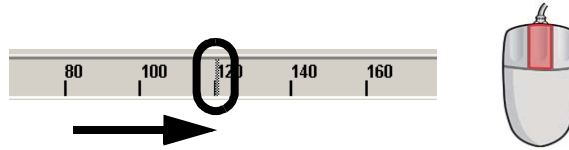

- 3 In the Channel Box, set the UValue for MotionPath1 to 0.1.
The aircraft is repositioned along the curve near the first bend. When you set the UValue to 0.1, the aircraft is positioned at a point that is a distance of 10 percent from the beginning of the curve (that is, the aircraft has completed 10 percent of the distance along the path).
- 4 In the Channel Box, select the UValue channel by clicking on its name so it becomes highlighted.

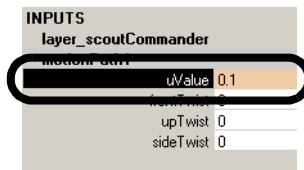

- 5 Right-click on the selected name.
A drop-down list appears.
- 6 From the drop-down list, choose Key Selected.
A position marker appears on the path curve indicating that a key frame has been set. The position marker is useful for determining where the aircraft is at a given time. Position markers do not appear when you render the animation. Using Key Selected ensures that a keyframe is set only for the item selected and nothing else.

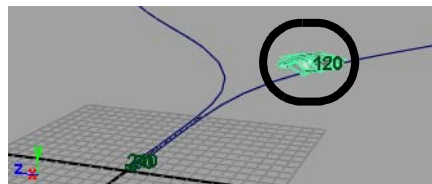

- 7 In the Time Slider, middle-drag the current time indicator to frame 180.

6 | Animation

Lesson 3 > Changing the timing of an object along a motion path

- 8 In the Channel Box, set the UValue for MotionPath1 to 0.9.

The aircraft is repositioned along the curve near the last bend. When you set the UValue to 0.9, the aircraft is positioned at a point that is a distance of 90 percent from the beginning of the curve. (that is, the aircraft has completed 90 percent of the distance along the path)

- 9 In the Channel Box, select the UValue channel by clicking on its name so it becomes highlighted.
- 10 Right-click on the selected name and choose Key Selected.
A position marker appears on the path curve.

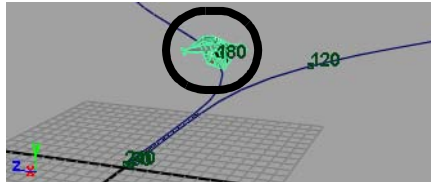

- 11 Click play on the Time Slider's playback control to play back the animation.
The motion of the aircraft is not smooth as it travels along the path. It initially moves forwards and backwards a bit at the beginning and end of the path. This indicates that some adjustment of the animation is required. You adjust the animation using the Graph Editor.

To view the Graph Editor

- 1 From the main menu, select Window > Animation Editors > Graph Editor.
The Graph Editor appears.
- 2 In the Graph Editor, select View > Frame All.
The Graph Editor updates to display the animation curve for the motion path animation.

Lesson 3 > Changing the timing of an object along a motion path

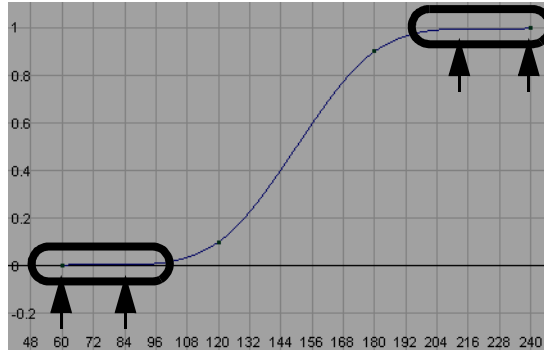

The shape of the animation curve provides some clues as to why the motion of the aircraft is not smooth. Between frames 60 and 84 the curve rises and then drops slightly. Because the animation curve represents translation along the curve, a drop in the curve indicates that the object travels backwards. A similar occurrence happens at the end of the curve as well. To correct this, you need to modify the tangents for the keys in the Graph Editor.

To edit the tangents for the keys in the Graph Editor

- 1** In the Graph Editor, press the shift key, then double click on the animation curve to select the four keys (frames 60, 120, 180 & 240)
- 2** In the Graph Editor menu, select Tangents > Linear.

The animation curve updates so that the keys connect via straight lines. This eliminates the dips in the curve that caused the aircraft to travel backwards.

6 | Animation

Lesson 3 > Changing the timing of an object along a motion path

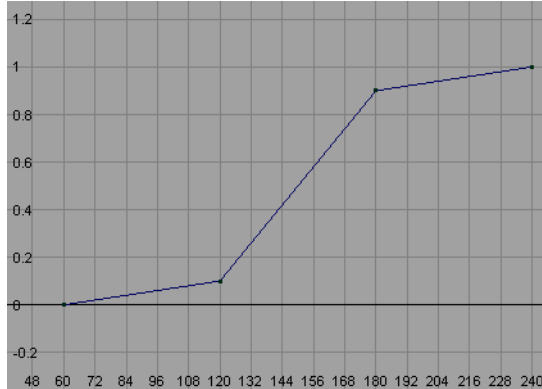

Next, you modify the tangents for keys 120 and 180 so the aircraft accelerates and decelerates near those points on the path curve.

3 In the Graph Editor, shift-select only the two keys for frames 120 and 180.

4 In the Graph Editor menu, select Keys > Break Tangents.

Breaking the tangent for the keys allows you to modify the shape of the curve as it enters or leaves a key.

5 Select only the key for frame 120.

A pair of tangent handles appear on either side of the key. The handles let you edit the curvature of the animation curve near the key point.

6 Select the tangent handle to the right of the key.

The handle highlights in a yellow color.

7 From the Toolbox, select the move tool.

8 Using the middle mouse button, drag the handle so the curve has a gentle curvature as it leaves the key as shown below.

Modifying the tangent in this manner changes how the motion transitions as the curve changes direction as it passes through the key. The aircraft will accelerate smoothly instead of immediately travelling at a different rate of speed.

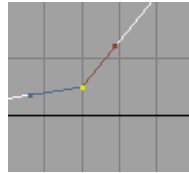
Lesson 3 > Changing the timing of an object along a motion path

Before Modification

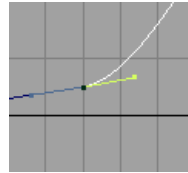

After Modification

- 9** Select the key for frame 180.
- 10** Select the handle to the left of the key.
The handle highlights in blue.
- 11** Using the middle mouse button, drag the handle so the curve has a gentle curvature as it enters the key as shown below.
Modifying this tangent for this key will cause the aircraft to decelerate smoothly near the end of its travel.

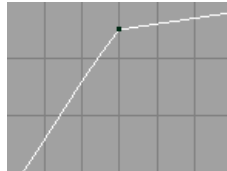

Before Modification

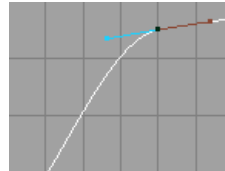

After Modification

6 | Animation

Lesson 3 > Rotating an object along a motion path

The modified animation curve appears as shown below.

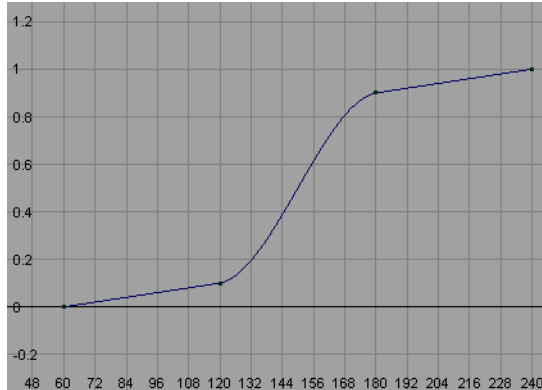

12 Close the Graph Editor.

13 Click play on the Time Slider's playback control to play back the animation.

The backwards and forwards motion that previously occurred is corrected. The aircraft travels slowly towards the first bend in the path curve, then accelerates and travels at a constant speed around the curve until it nears the end of the path where it decelerates and then slowly moves towards the end of the curve.

Rotating an object along a motion path

As the aircraft travels along the motion path, its orientation remains the same throughout the animation. A real aircraft rolls to one side (banks) as it flies in an arc. To make the aircraft roll to one side as it travels along the path you set keyframes for the Twist attributes in the Channel Box.

To animate the roll of the aircraft along the path

1 Ensure the aircraft is selected.

2 Set the Time Slider to frame 120.

The aircraft is repositioned along the curve near the first bend.

3 In the Inputs section of the Channel Box, click on motionPath1 to view its attributes.

- 4 Ensure the FrontTwist value for motionPath1 is set to 0.
- 5 In the Channel Box, select the FrontTwist channel by clicking on its name.



- 6 Right-click on the selected name.
A drop-down list appears.
- 7 From the drop-down list, choose Key Selected.
- 8 To set the remaining keyframes for the rotation of the aircraft, use the table below as a guide, keeping in mind that you set the keyframes in the following order:
 - Set the frame in the Timeslider
 - Set the values for FrontTwist in the Channel Box.
 - Select the FrontTwist channel by clicking its name. Right-click on the selected name and choose Key Selected.

Frame	Select	Set channel attribute	Choose
130	Aircraft	FrontTwist: -15	key selected
135	Aircraft	FrontTwist: -45	key selected
150	Aircraft	FrontTwist: -70	key selected
165	Aircraft	FrontTwist: -45	key selected
170	Aircraft	FrontTwist: -15	key selected
180	Aircraft	FrontTwist: 0	key selected

6 | Animation

Lesson 3 > Blending keyframe and motion path animation

- 9 Click play on the Time Slider playback controls to play back the animation. The aircraft rolls to one side (banks) as it travels along the motion path.

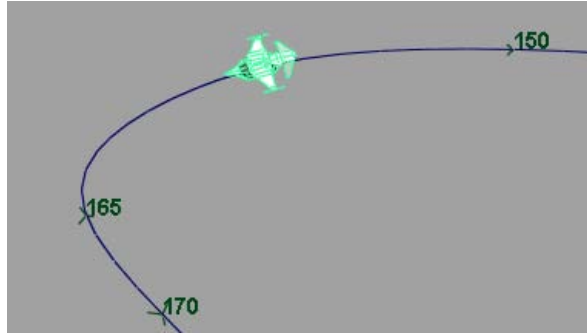

Blending keyframe and motion path animation

Blending between motion path and keyframe animation types is possible in Maya. Blending between the two animation types allows you to take advantage of the characteristics each animation type can provide without having to expend a lot of effort in determining where the change between the two types must occur.

In the steps that follow, you keyframe the aircraft to rise vertically from the floor surface and then travel along the motion path by blending between the two animation types. To accomplish this, you do the following:

- Move the motion path up above the ground plane.
- Keyframe the aircraft so it rises vertically above the ground plane.
- Blend between the keyframe and motion path animations.

To move the motion path

- 1 In the scene view, select only the path curve.
- 2 In the Channel Box, set Translate Y to 5 for PathCurve.

The path curve is repositioned above the ground plane in the scene view. The aircraft moves with the path curve because it is attached to the motion path.

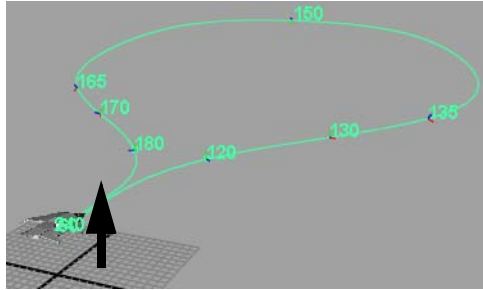
Lesson 3 > Blending keyframe and motion path animation**To keyframe the motion for the aircraft**

- 1** Select only the aircraft.
- 2** Set the Timeslider to frame 1.
- 3** In the Channel Box, set the following for the aircraft:
 - Translate Y: 0
 The aircraft is repositioned so it rests on the ground plane.
- 4** Select the Translate X, Y, and Z channels as well as the Rotate X, Y, and Z channels by click-dragging on their names so they become highlighted.

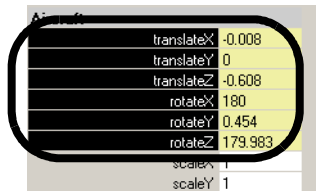

- 5** Right-click on any of the highlighted names, and choose Key Selected from the drop down list that appears.
Keys are set for the selected channels. Keyframing these channels establishes a blending connection that will be discussed in subsequent steps.
- 6** In the Channel Box, set the following:
 - Rotate Y: - 90
 The aircraft is rotated 90 degrees from its motion path position.

6 | Animation

Lesson 3 > Blending keyframe and motion path animation

- 7 Select the Rotate Y channel by clicking on its name so it becomes highlighted.
- 8 Right-click on the name, and choose Key Selected from the drop down list that appears.

A keyframe is set for the aircraft.

Additional channels have appeared in the Channel Box. When a keyframe is set for an object that already has motion path animation, the software automatically creates a connection to blend between the two animation types. These new channels are used to control the blend between the keyframe and motion path animation types. They control the blend for the Translation and Rotation attributes.

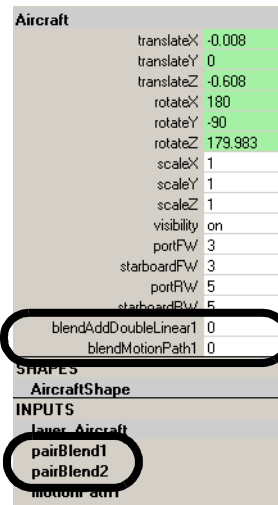

- 9 To set the remaining keyframes for the keyframe motion of the aircraft, use the table below as a guide, keeping in mind that you set the keyframes in the following order:
 - Set the frame in the Time Slider.
 - Set the Translate and Rotate values in the Channel Box.
 - Select only the channels for those values. Right-click on the selected name and choose Key Selected.

Frame	Select	Set channel attribute	Choose
20	Aircraft	Translate Y: 1	key selected
30	Aircraft	Translate Y: 2	key selected
30	Aircraft	Rotate Z: 170	key selected
40	Aircraft	Translate Y: 3	key selected
40	Aircraft	Rotate Z: 170	key selected

- 10** Click play on the Timeslider playback controls to play back the animation. The aircraft rises above the ground plane and then stops at frame 40.

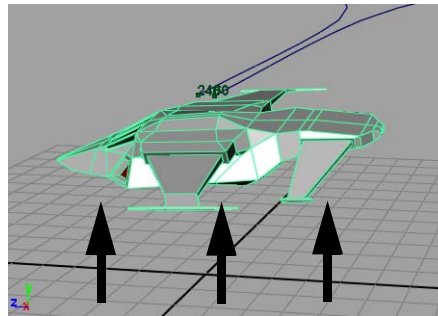

The animation stops because the motion path animation was shut off when the blend attribute was automatically created when you set the first keyframe. The blend attribute values are set to zero by default. When the blend values are set to zero, the keyframe animation has full influence on the object, and the path animation is shut off. When the blend values are set to one, the motion path has full influence on the object and the keyframing is shut off. When the blend values are between zero and one, the aircraft's motion is blended between the keyframe and motion path animation.

6 | Animation

Lesson 3 > Blending keyframe and motion path animation

In the next steps, you keyframe the blending attributes so the blending begins at frame 30 and ends at frame 70. This blends the two animation types together over a period of 40 frames.

To blend between the two animation types

- 1 Set the Timeslider to frame 30.
- 2 In the Channel Box, ensure the blend values are set as follows:
 - BlendAddDoubleLinear: 0
 - BlendMotionPath: 0
- 3 Select the BlendAddDoubleLinear1 and BlendMotionPath1 channels by click-dragging on their names so they become highlighted.

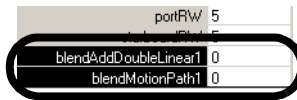

- 4 Right-click on one of the names, and choose Key Selected from the drop down list that appears.

A key is set for the blend starting point for the aircraft. At frame 30 the two animation types will begin to blend together.

- 5 Set the Timeslider to frame 70.
- 6 In the Channel Box, set the following:
 - BlendAddDoubleLinear1: 1
 - BlendMotionPath1: 1
- 7 Right-click on one of the names, and choose Key Selected from the drop down list that appears.

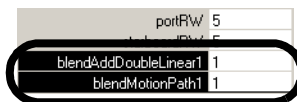

A key is set for the blend ending point for the aircraft. At frame 70 the motion path animation will have full influence.

- 8 Click play on the Timeslider playback controls to play back the animation.

Lesson 3 > Blending keyframe and motion path animation

The two animation types are combined but the motion does not appear correct. The aircraft rotation flips upward momentarily when it begins to travel along the motion path.

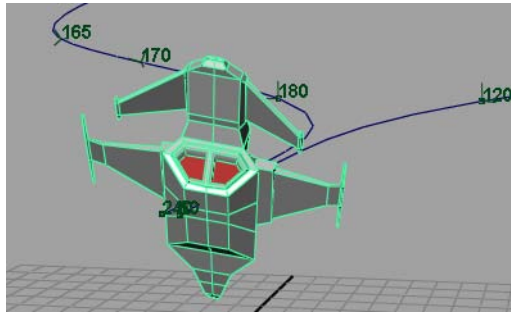

The interpolation type for the rotations during the blending is not set correctly.

Setting the pairBlend rotInterpolation setting to Quaternions changes how the rotations are interpolated during the blend. In this example, Quaternions provides a better interpolation type when blending between the keyframe and motion path animation. For more information see *quaternion rotation* in the Maya Help.

To edit the rotation interpolation type for blending

- 1 In the Channel Box, click on the pairBlend1 channel.
- 2 Scroll the Channel Box so you can view the Attributes for pairBlend1.
- 3 Set the Rot_Interpolation setting to Quaternions by clicking on the Euler angles name with the left mouse button.

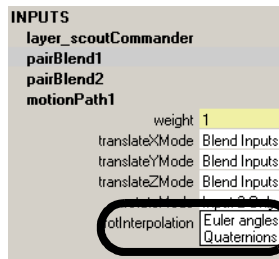

6 | Animation

Lesson 3 > Using Playblast to playback an animation

- 4 Click on the pairBlend2 channel.
- 5 Click on the Euler angles name in the Rot_Interpolation attribute and choose Quaternions.
- 6 Click play on the Timeslider playback controls to play back the animation.
The animation plays back smoothly. Observe how the blending also takes into account the rotation of the aircraft so it meets up with the motion path smoothly.

Using Playblast to playback an animation

Playblast allows you to preview an animation by calculating the separate frames and playing them back in a multimedia player window based on the Playblast options. Playblast provides a more accurately timed playback than using the Timeslider.

To playback the animation using Playblast

- 1 Select the path curve, and then select Display > Hide > Hide Selection to hide the curve while you Playblast.
- 2 Select Window > Playblast.
Playblast calculates the frames for the animation and then plays them back in the player window.

You have completed this lesson.

Beyond the lesson

In this lesson you learned how to:

- Create a motion path animation using a NURBS curve as the motion path.
When you draw your own curves remember that a curve has a defined start and an end point based on how you create it. If your object is initially positioned at the wrong end of the curve, you can reverse the direction of the curve by setting the Menu Set to Modeling and then selecting Edit Curves > Reverse Curve Direction.

If your objects are not oriented correctly on the path initially, you can change the options in the Attach to Motion Path Options window. See [Animate > Motion Paths > Attach to Motion Path](#) in the Maya Help.

- Adjust the timing and rotation of an object when it travels along the motion path.

In this lesson you were shown how to keyframe the roll (bank) of the aircraft. The Attach to Motion Path Options window provides an option called Bank. The Bank option rotates an object as it travels around curved portions of a motion path. It is useful for simple motion path animation.

- Blend between keyframe and motion path animation types on the same object.

For more information on how this works, see [pairBlend](#) in the Maya Help.

6 | Animation

Lesson 4 > Beyond the lesson

Lesson 4 Nonlinear animation with Trax

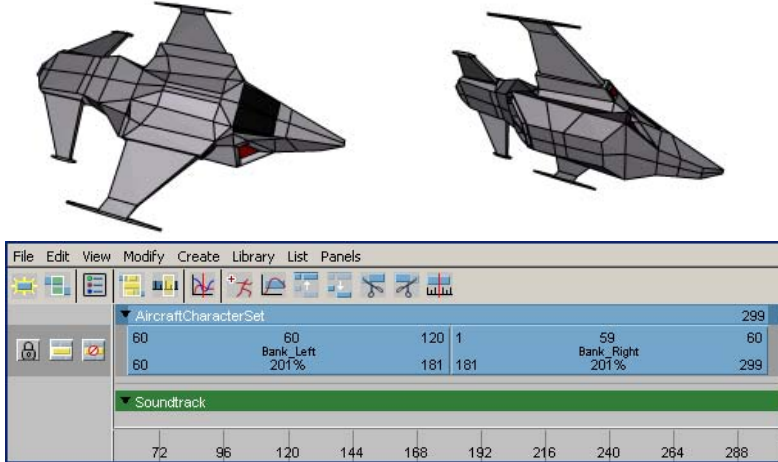

Nonlinear animation allows you to create and edit an animation sequence by arranging smaller animation sequences (known as *clips*) on a timeline. A clip is a time-independent sequence of animation that you create from an existing animation (keyframe animation, expressions, constraints, and motion capture data - *except* motion path animation).

Nonlinear animation tools in Maya® Trax™ give you the ability to experiment with your animation sequences and character animations without having to redo all of your work when you want to modify or construct a different animation.

Nonlinear animation is a non-destructive process. You can modify a particular clip's attributes without affecting the source animation: the source material remains untouched. This makes nonlinear animation useful when you want to experiment, iterate, or change a particular animation sequence.

The primary tool for working with nonlinear animation is the Trax Editor. You can also store your clips for future use by creating a library of clips.

In this lesson you learn how to:

- Key animation sequences for use as nonlinear clips in Trax.

Getting Started with Maya

- Create clips from your animation sequences for use in the Trax Editor.
- Use the Trax editor to position, modify, and arrange clips in order to create and modify animation sequences in the scene.
- Scale clips to modify the timing of an animation sequence.
- Trim clips to remove unwanted motion.
- Cycle clips to create motion that repeats.
- Use the Graph Editor to modify the animation of a clip.
- Use the Trax Editor to work with motion capture data.
- Reuse clips using the Outliner and the Visor.

Open the first scene for the lesson

This lesson is presented in two parts. You work with two separate scene files we've created for your use. In the first part of this lesson, you learn some of the fundamental techniques for working with clips in the Trax Editor by animating an aircraft taking off and landing.

- 1** Make sure you've done the steps in "Preparing for the lessons" on page 165.
- 2** Open the scene named `Trax_Lesson1.mb`.

You can open the scene named `Trax_Lesson1.mb` from the *Maya Documentation, Lessons, and Extras* CD or from the drive where you copied the Getting Started files.

The scene contains a model of an aircraft. For the first part of this lesson, you create and work with animation clips to control the motion of the aircraft.

6 | Animation

Lesson 4 > Open the first scene for the lesson

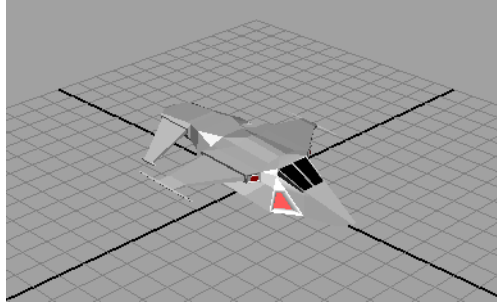

3 In the Time Slider, set the Playback range as follows:

- Playback Start Time: 1
- Playback End Time: 240

To work more efficiently with the scene and the Trax Editor, you need to set a panel layout.

To set a panel layout for use with the Trax Editor

1 From the perspective view's menu, select Panels > Saved Layouts > Persp/Trax/Outliner.

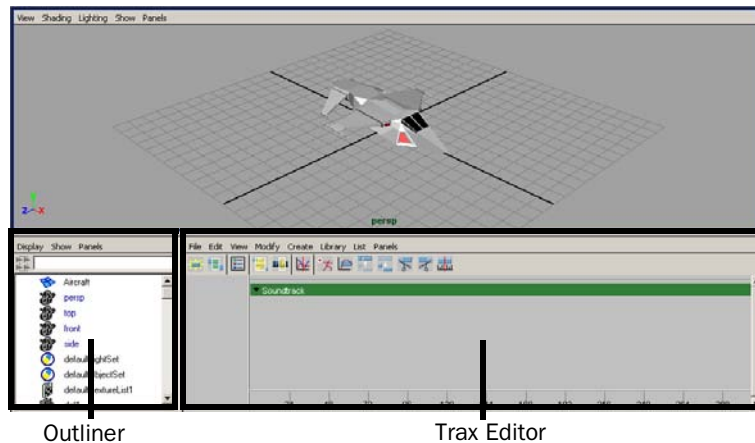

The panel layout updates to display the Perspective view, Outliner, and Trax Editor simultaneously. This allows you to easily work with these windows without having to open and close them repeatedly.

Next, set the Outliner so it displays clips. The Outliner allows you to manage the various clips that get created with Trax.

To set the Outliner to display clips

- 1** In the Outliner menu, select Display > DAG Objects Only to uncheck the DAG option.
- 2** In the Outliner menu, select Show > Objects > Clips.
The Outliner displays an empty list until you create your first clip.

Creating clips with Trax

A clip is a time-independent sequence of animation data for one or more animated attributes that you create from existing animation (keyframe animation, expressions, constraints, motion capture data, and so on). A clip is time independent, allowing you to position, scale, and cycle a clip independently of other animatable attributes or other clips. This means you can arrange the clips into a particular sequence, and then play it back to see the results. You can adjust the timing, length, and rearrange or edit the same clips in a different order to modify the motion sequence.

Most commonly-used clips are reusable sequences of animation that are easy to sequence or blend with other clips. For example, suppose you create three clips: a karate punch, tumble, and kick. You can run the clips in any order, and you can repeat clips or blend the motion between them. You can scale or cycle clips to alter the time frame over which the animation occurs. You can either return the clip to its original state or reload a duplicate of the original source clip and begin again. In this way, the Trax Editor allows you to experiment with animation sequences on a character.

In the steps that follow, you key some animation for the aircraft and then create clips from the keyed animation for use in the Trax Editor.

6 | Animation

Lesson 4 > Creating clips with Trax

To create keyframe animation for the aircraft

- 1 From the perspective view's panel menu, select Panels > Orthographic > front.
The panel updates to display the aircraft's side from the front view.
- 2 In the front view, click on the aircraft to select it.
- 3 In the Channel Box, set the following:
 - Translate X: -25The aircraft is repositioned at -25 along the X axis. The aircraft disappears from the front view because it has been repositioned outside of the viewing area.
- 4 Dolly and track the front view until the aircraft appears on the lower left hand side of the front view as shown below.

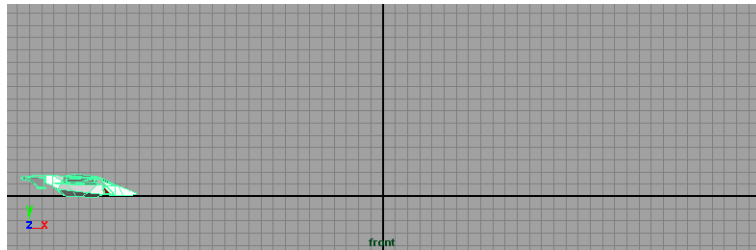

- 5 Press s to set a keyframe.
In the Channel Box, the channels display in a different color. The color change indicates that the channels now have animation applied to them.

Note If you normally use the Auto Keyframe function, you must shut it off for this lesson. For more information see *Auto Key* in the Maya Help.

- 6 In the Time Slider, set the current time indicator to frame 240.
- 7 In the Channel Box, set the following:
 - Translate X: 25

The aircraft is repositioned at 25 along the X axis (the right hand side of the current front view).

- 8** In the Channel Box, select the Translate X channel by clicking on the name. The Translate X name becomes highlighted.



- 9** Right-click on the selected name and choose Key Selected from the drop-down list that appears.

Key Selected sets a keyframe for only the selected attribute.

Confirm that the animation sequence works as expected in the steps that follow.

To playback the animation using the playback controls

- 1** Click play on the Time Slider's playback control to play back the animation.



The aircraft travels from left to right in the front view.

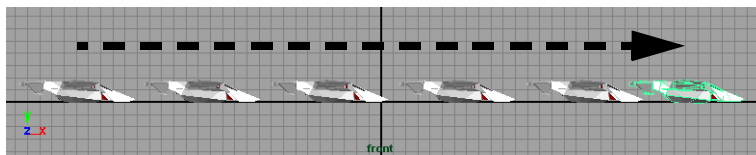

- 2** Click stop on the Time Slider's playback control.

Now that you have keyframed an animation sequence and confirmed that it works, you can create an animation clip.

6 | Animation

Lesson 4 > Creating clips with Trax

To create an animation clip of the keyframe animation

- 1 In the Trax Editor menu, with the aircraft still selected, select Create > Clip > .
- 2 In the Create Clip Options window, select Edit > Reset Settings, and then click on the Create Clip button.

The Outliner updates and lists two items: clip1 and clip1Source. If the clips do not display refer to "To set the Outliner to display clips" on page 213

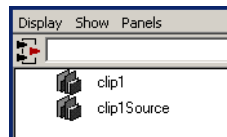

When you created the clip, two clips were generated: a *regular clip* and a *source clip*. The source clip contains the animation curves for the character (based on the keyed attributes that the clip was created from). The source clip is stored with the file and can only be accessed from the Visor or Outliner. Maya saves the source clip outside of the Trax Editor to protect the original animation curves from being accidentally modified and ensures you have an unmodified clip to revert back to.

A regular clip (referred to simply as a clip) contains the same information as the source clip, and is placed in a track in the Trax timeline. It is this regular clip that you work with and modify in Trax.

A clip does not yet appear in the track area of Trax Editor because the character set associated with the clip (the aircraft) has not been loaded to display.

- 3 In the Trax menu, with the aircraft selected, click the Load Selected Characters icon.



The clip appears as a blue rectangular box in a *track* in the Trax Editor. A track is an area in the Trax Editor to place and work with one or more non-overlapping clips in relation to the animation timeline. Tracks allow you to

work with your clips in a nonlinear manner by allowing you to reposition and scale clips in time or juxtapose them with other clips. You can work with multiple tracks in the Trax Editor.

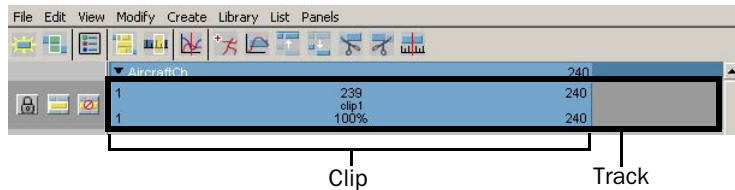

- 4 In the Trax menu, select View > Frame All.

The Trax Editor updates to show the beginning and end point for all of the items displayed in the Trax Editor. (In this case the new clip.) The clip represents the Translate X animation for the aircraft going from -25 to 25, for a time range of 1 to 240 frames.

Anatomy of a clip

Every clip contains interaction controls that relate to information about the clip:

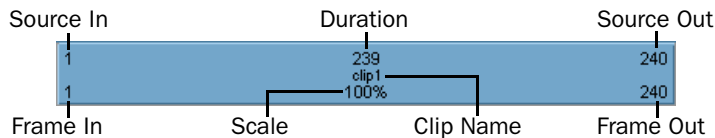

- *Frame In* and *Frame Out* indicates the current start and end frame numbers for the clip in relation to its position on the timeline.
- *Source In* and *Source Out* indicates the range of frames from the original source clip.
- *Duration* indicates the length (duration) of the original source clip in frames.
- *Clip Name*...the name of the clip. A default clip name is assigned to the clip, unless you specify it from the Create Clip Options window when you first create the clip.

6 | Animation

Lesson 4 > Creating clips with Trax

- *Scale* indicates the scale percentage for the clip. The scale percentage is the multiplier on the length of the original clip. For example, if you scale a clip fifty percent longer than its original length, the scale value would read 150%.

Each area on the clip has a hot spot which you can either double-click on for numeric values, and in some cases, click-drag to modify the related attribute. For example, you can double-click on the hot spot for the clip name to edit the name. For more information about clips and tracks, see *Track view area* in the Maya Help.

To edit the name of the clip in the Trax Editor

- 1 In the Trax Editor, double-click on the clip1 name on the clip.
The clip highlights in yellow to indicate it is selected and the clip1 name becomes highlighted.
- 2 Type `Travel_Forward` and then press Enter.
The clip is renamed to `Travel_Forward`. The clip and the source clip's name are updated in the Outliner to reflect the change.

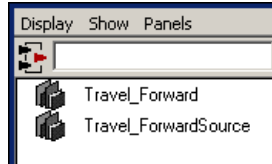

If you play this clip in Trax, the animation is played back from the clip data, not the keyframe data that you set previously in the scene. When you created the clip, the source of the animation for the aircraft was changed to come from the clip instead of the keyframes.

When you create a clip, Maya creates a *character set* to contain the clip. A character set is the parent of the hierarchy of clips and tracks for a particular animated object. A clip's animation resides under the character set node and additional clips are placed under that node unless you specify otherwise.

For more information see *Nonlinear animation components in Trax* in the Maya Help.

Now that you have created your first animation clip and renamed it using the Trax Editor, you need to create a few more clips by setting additional keys and creating clips of the sequences. You need to create separate clips of the aircraft taking off and landing.

To create an animation clip of the aircraft taking off

- 1** In the scene view, select the aircraft.
- 2** In the Channel Box, set the following:
 - Translate Y: 0
- 3** In the Channel Box, select the Translate Y name so it becomes highlighted.

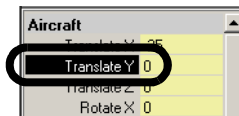

- 4** Right-click on the name and choose Key Selected to set a keyframe for this position.
Key Selected sets a keyframe for only the selected attribute.
- 5** In the Time Slider, drag the current time indicator to frame 60.
- 6** In the Channel Box, set the following:
 - Translate Y: 7.0
- 7** In the Channel Box, select the Translate Y name so it becomes highlighted.

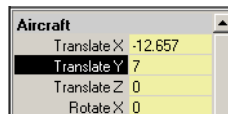

- 8** Right-click on the name and choose Key Selected to set a keyframe for this position.
- 9** In the Trax Editor menu, with the aircraft selected, select Create > Clip (or click the Create Clip icon on the Toolbar)

6 | Animation

Lesson 4 > Creating clips with Trax

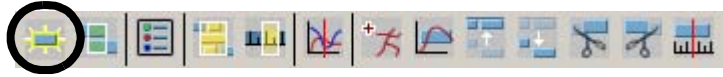

The Trax Editor updates to create an additional track and places the new clip on the new track. The Outliner updates to list the new clip and source clip.

- 10** In the Trax Editor, double-click on the new clip and rename it to Aircraft_Rise.

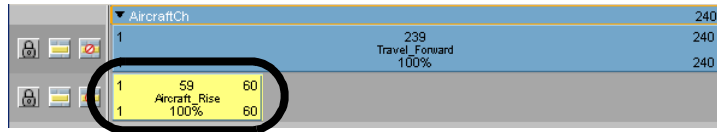

- 11** Click play on the Time Slider's playback control to play back the animation.

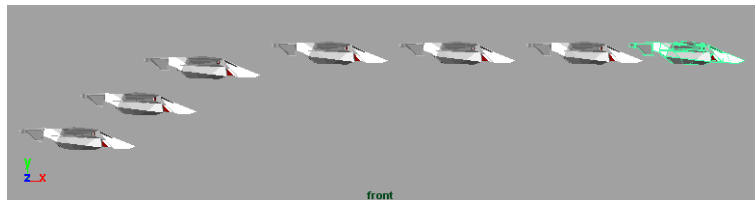

The aircraft rises as it travels forward.

- 12** Click stop on the Time Slider's playback control.

To create an animation clip of the aircraft landing

- 1** In the Timeslider, set the current time indicator to frame 180.
- 2** In the Channel Box, with the aircraft still selected, set Translate Y to 7.
- 3** In the Channel Box, select the Translate Y name so it becomes highlighted.
- 4** Right-click on the name and choose Key Selected to set a keyframe for this position.
- 5** In the Time Slider, set the current time indicator to frame 240.
- 6** In the Channel Box, set the Translate Y to 0.
- 7** In the Channel Box, select the Translate Y name so it becomes highlighted.

- 8** Right-click on the name and choose Key Selected to set a keyframe for this position.
- 9** Click play on the Time Slider playback controls to play back the animation.

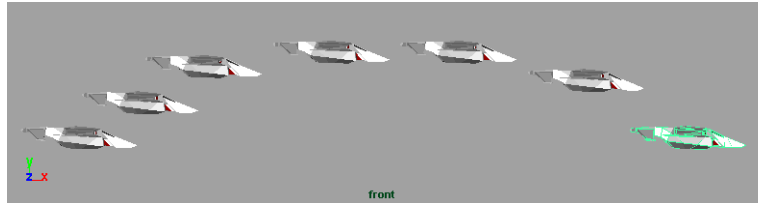

The aircraft travels forward and then lands as it nears the end of its travel.

- 10** Click stop on the Time Slider’s playback control.
- 11** In the Trax Editor menu, with the aircraft selected, select Create > Clip. The Trax Editor and Outliner update to show the new clip.
- 12** In the Trax Editor, double-click on the new clip and rename it to Aircraft_Lower.

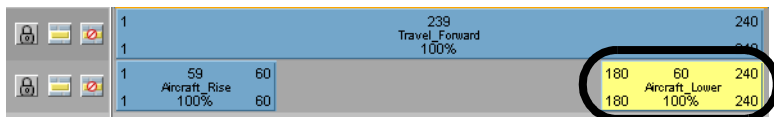

Changing the position of clips with Trax

It’s easy to alter the start time of clips to synchronize the action between clips. For example, the aircraft rises as it travels forward because the Travel_Forward and Aircraft_Rise clips overlap in time. If you position the clips on their respective tracks so that one clip’s action occurs in the Trax timeline before or after the other, the motion occurs separately.

In this section, you learn how to reposition the clips so that the aircraft takes off before it travels forward in X, and then have the aircraft land at the end of the sequence.

6 | Animation

Lesson 4 > Changing the position of clips with Trax

To change the position of a clip in a track

- 1 In the Trax Editor, move the mouse cursor over top of the Travel_Forward clip.
When the mouse cursor is over top of a clip in the Trax Editor, the cursor icon changes to a pointer indicating that you can drag the clip to either side or up and down between tracks.



Move Cursor

- 2 Click-drag the Travel_Forward clip horizontally to the right in its track until the Frame In reads 60 as shown below.

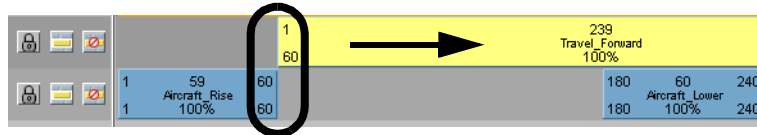

- 3 Click play on the Time Slider playback controls to play back the animation.

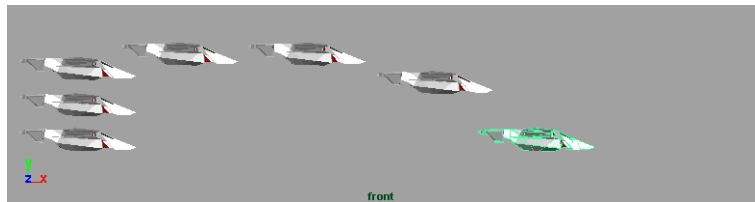

The aircraft takes off vertically, then travels to the right, and lands while it is still travelling to the right. Because the two clips (Travel_Forward and Aircraft_Rise) are positioned one after the other, the actions occur in a series versus simultaneously.

- 4 Click stop on the Time Slider's playback control.
- 5 Click-drag the Aircraft_Lower clip horizontally to the right until the beginning of the clip matches the end of the Travel_Forward clip on the track above it. (Frame In = 240)

If the view of the clips appears limited, select View > Frame All in the Trax Editor to resize the view to encompass the clips.

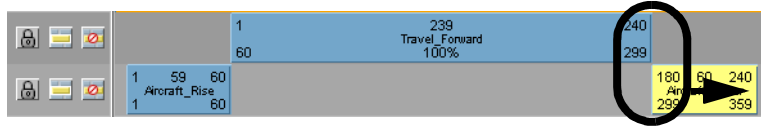

You also need to modify the Playback End Time because the animation timeline is longer as a result of repositioning the clips.

- 6 In the Time Slider, edit the Playback range as follows:
 - Playback End Time: 360
- 7 Click play on the Time Slider playback controls to play back the animation.

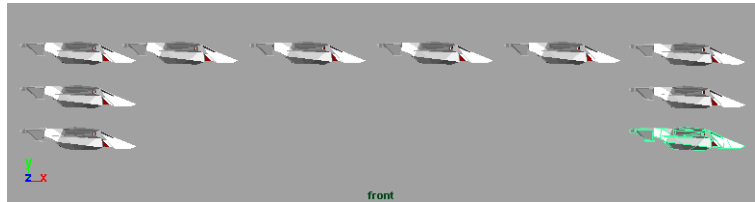

The aircraft takes off vertically, then travels to the right, and then lands vertically once the Travel_Forward clip's motion is complete. Because the three clips are positioned end to end in relation to the timeline, the animation occurs as a series of separate events.

- 8 Click stop on the Time Slider's playback control.

Editing the animation of clips

You can modify the animation of a clip using the Graph Editor in the same way that you would modify any other type of animation. Because you are working with the clip, and not the original animation, you won't change the original source clip animation.

In this section, you use the Graph Editor to modify the animation for each clip so the aircraft's motion accelerates and decelerates at the beginning and end of each clip.

6 | Animation

Lesson 4 > Editing the animation of clips

To use the Graph Editor to modify a clip in Trax

- 1 Click on the Aircraft_Rise clip to select it.
The selected clip highlights in yellow.
- 2 From the Trax menu, select View > Graph Anim Curves.
The Graph Editor appears.
- 3 In the Graph Editor, shift-select the two keys on the animation curve as shown below.
- 4 In the Graph Editor, select Tangents > Flat.

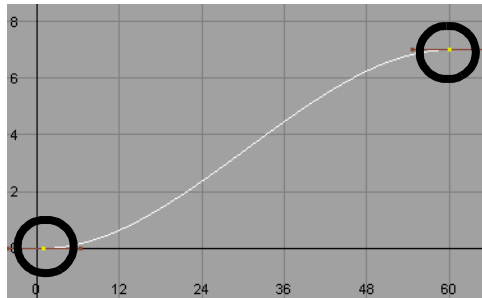

The shape of the animation curve updates to a gentle S-shape. Setting the tangents for the animation curve in this manner modifies the clip's animation to cause the aircraft to accelerate when it first rises, and decelerate when it nears the end of its vertical travel.

- 5 Repeat steps 1 through 4 to set the animation curve tangents in a similar manner for the two remaining clips: Travel_Forward and Aircraft_Lower.
The shape of the animation curve for Aircraft_Lower will be reversed from the other clip curves because the motion is occurring in the opposite direction.
- 6 Close the Graph Editor window.
- 7 Set the Time Slider's current time indicator to frame 1.
- 8 Click play on the Time Slider's playback control to play back the animation.

The motion accelerates and decelerates at the beginning and end of each clip. As a result, the motion appears more natural. It's important to note that the modified tangents for each clip are independent from the other animation clips and do not affect any other motion.

- 9 Click stop on the Time Slider's playback control.

Reusing clips within Trax

You can save and reuse clips for future use. You can key specific types of motion or attribute effects, save them as clips, and reuse the clips for other characters.

When you reuse a clip created for one character and apply it to another, the clip attributes must be mapped to correspond between the two characters. For more information see *What is Character Mapping?* in the Maya Help.

In this lesson, you work with clips created for this aircraft animation. The clips contain animation to make the aircraft shift to the left and right and bank left and right.

To load a clip from disk

- 1 From the Trax menu, select File > Import Clip.

The File Browser appears. When importing a clip, the File Browser defaults to the clip directory of your current project.

You can open the clip `Bank_Left.ma` from the *Maya Documentation, Lessons, and Extras CD* or from the drive where you copied the Getting Started files.

The file will be found in the clip sub-directory.

- 2 Select the file named `Bank_Left.ma` and click the Import button.

The clip is imported and appears in the Outliner named as `Bank_LeftSource` to indicate it is a source clip.

- 3 Repeat steps 1 and 2 to import the clips `Bank_Right`, `Shift_Left` and `Shift_Right`.

When you have finished, four new clips appear in the Outliner as source clips. In the steps that follow, you place and position the clips on tracks in the Trax Editor.

6 | Animation

Lesson 4 > Reusing clips within Trax

Note When you import clips they also appear in, and can be accessed from, the *Visor* (Window > General Editors > Visor). The Visor is a graphical interface that allows you to import items that reside on disk or in your current file (files, textures, clips poses, etc.). Clips that are assigned to a character in Trax will appear listed under the Character Clips tab in the Visor. Clips that have not yet been placed on a track will appear listed in the Visor under the Unused Clips tab.

To place clips into a track from the Outliner

- 1 In the Outliner, drag the clip named `Bank_LeftSource` into the same track as the Rise and Lower clips using the middle mouse button. Ensure you drag into an open area on the track that the clip will fit into.

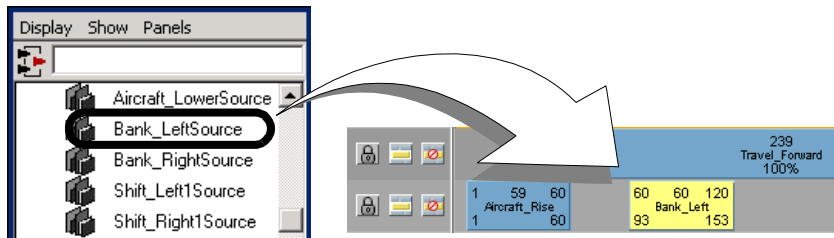

- 2 Position the `Bank_Left` clip on the track so its Frame In number matches the Frame Out number on the `Aircraft_Rise` clip, as shown below.

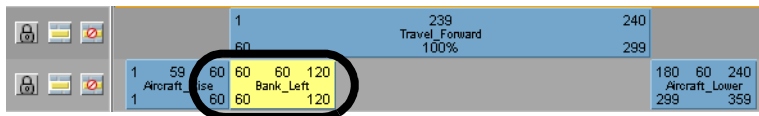

- 3 Drag the clip named `Bank_RightSource` from the Outliner into the same track as the Rise and Lower clips using the middle mouse button. Ensure you drag into an open area on the track that the clip will fit into.
- 4 Position the `Bank_Right` clip on the track so its Frame In number matches the Frame Out number on the `Bank_Left` clip, as shown below.

6 | Animation

Lesson 4 > Reusing clips within Trax

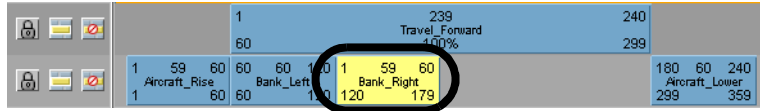

You can also drag clips from the Outliner or Visor into the Trax Editor and create a new track for them to be placed in.

- 5 Drag the clip named Shift_Left1Source from the Outliner using the middle mouse button, but this time, drag to the narrow blue area above the tracks before releasing your middle mouse button.

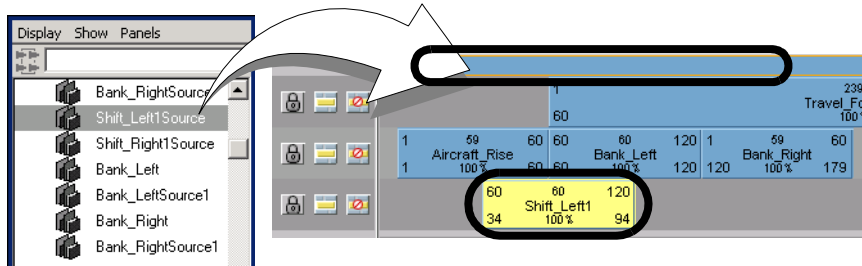

A new track appears in the Trax Editor and the clip is placed on the new track.

The narrow blue box is the *summary track* for the character set (in this case the Aircraft) The summary track represents all of the clips under a character, subcharacter, or group. When you import a clip onto the summary area by dragging it from the Outliner or Visor, the Trax Editor creates a new track for the clip.

- 6 Click-drag the Shift_Left clip so it lies directly below the Bank_Left clip on the track above it.

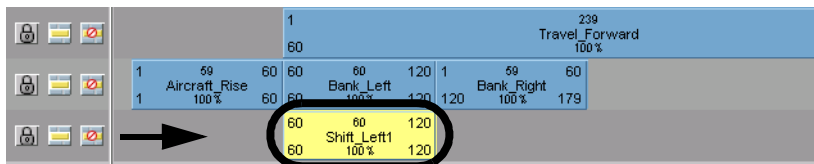

6 | Animation

Lesson 4 > Reusing clips within Trax

Because the Shift_Left clip is positioned directly below the Bank_Left clip, the actions will occur simultaneously when the animation is played back.

- 7 Drag the clip named Shift_Right1Source from the Outliner into the same track as the Shift_Left clip using the middle mouse button. Ensure you drag into an open area on the track.
- 8 Position the Shift_Right clip on the track so its Frame In number matches the Frame Out number on the Shift_Left clip, as shown below.

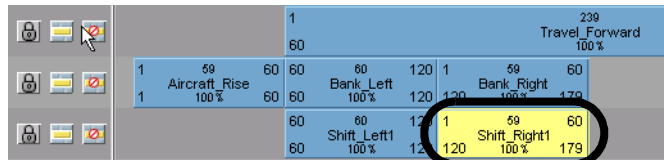

- 9 In the front view menu, select Panels > Perspective > persp.
The view updates to display the aircraft from a perspective view.
- 10 Dolly and track the view so you can fully see the area the aircraft will travel within.
- 11 Click play on the Time Slider's playback control to play back the animation.

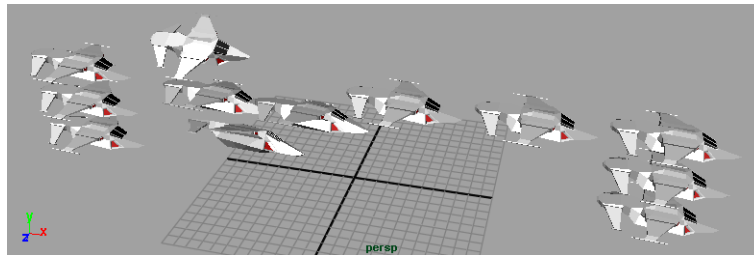

After the aircraft rises, it travels forwards as before but now it shifts sideways to the left while one wing tips downwards, and then shifts sideways to the right, while the opposite wing tips downwards.

- 12 Click stop on the Time Slider's playback control.

Soloing and muting tracks

Soloing a track allows you to see a track play back in isolation from other tracks. When a track is soloed, the other tracks are disabled and do not play back. Soloing is useful when you want to review the effect a specific track will have on a character.

To solo a track

- 1 In the Trax control area, click the Solo button for the track that contains the Aircraft_Rise and Bank_Left clips.

The other tracks dim to indicate that they will be disabled when the animation is played back.

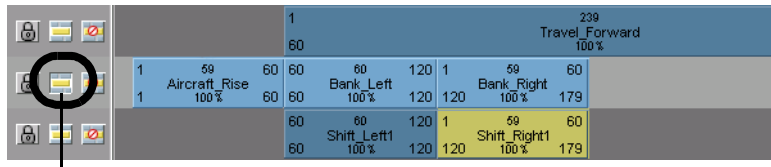

Solo button

- 2 Click play on the Time Slider's playback control to play back the animation. The aircraft rises, tilts left and right, and then lowers, without moving forward. Because the other tracks have been shut off temporarily, the aircraft's motion is controlled by only one track.
- 3 Click stop on the Time Slider's playback control.
- 4 Click the Solo button again to enable all the tracks. The dimmed tracks become active again.

Muting a track disables only the selected track so it does not play back. Muting is useful when you want to review the animation on one or more tracks together without specific tracks being activated. You can mute one or more tracks.

To mute a track

- 1 In the Trax control area, click the Mute button for the track that contains the Shift_Left and Shift_Right clips.

6 | Animation

Lesson 4 > Scaling clips within Trax

The muted track dims to indicate it is disabled.

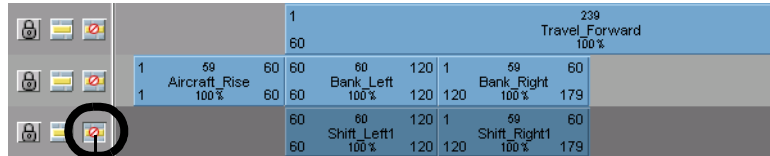

Mute button

- 2 Click play on the Time Slider's playback control to play back the animation. The aircraft rises and tilts left and right as it travels forward, and then lowers. Because the Shift_Left and Shift_Right track is temporarily muted, only the two remaining tracks affect the animation playback.
- 3 Click stop on the Time Slider's playback control.
- 4 Unmute the track by clicking its mute button before proceeding to the next section.

Scaling clips within Trax

You can scale single or multiple clips within the Trax Editor. Scaling a clip either compresses or expands the animation of a clip so it occurs over a shorter or longer period of time. The resulting animation occurs faster or slower as a result.

In the next steps, you select the four clips you imported to Trax, and scale them together so they occur over the same time frame as the Travel_Forward clip.

To scale multiple clips in the Trax Editor

- 1 In the Trax Editor, shift-click on the clips: Bank_Left, Bank_Right, Shift_Left1, and Shift_Right1. The *clip manipulator* appears. The clip manipulator appears as a white box that encompasses the four clips with handles (triangles) on either end and a circle handle in the center. The clip manipulator allows you to move or scale multiple clips.
- 2 Using the clip manipulator, click-drag the right-hand scale handle to the right until the Frame Out numbers on the Bank_Right and Shift_Right clips match the Travel_Forward clip (Frame 299).

6 | Animation

Lesson 4 > Open the second scene for the lesson

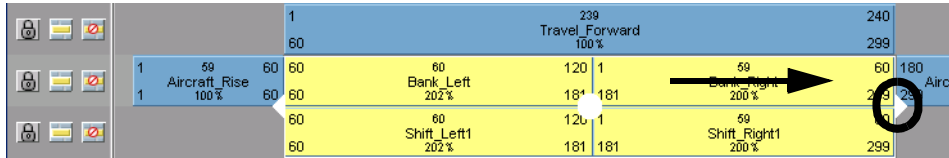

Time	Property	Value	Scale
1	Travel_Forward	239	100%
60	Travel_Forward	240	100%
59	Aircraft_Rise	60	100%
60	Aircraft_Rise	60	100%
60	Bank Left	181	202%
60	Bank Left	181	202%
60	Shift_Left1	181	202%
60	Shift_Left1	181	202%
59	Bank Right	180	200%
60	Bank Right	180	200%
59	Shift_Right1	181	200%
60	Shift_Right1	181	200%

- 3 Click play on the Time Slider playback controls to play back the animation.

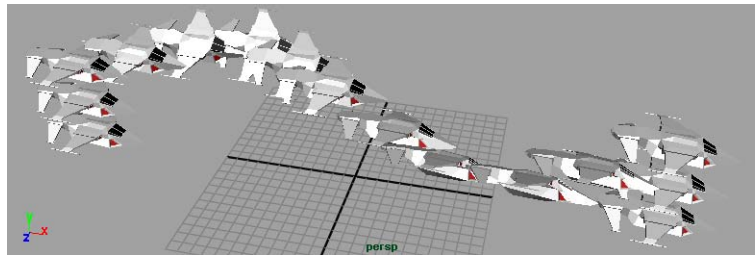

When the aircraft travels, the sideways and banking motions occur over the entire length of the Travel_Forward clip.

- 4 Click the stop button on the playback controls to stop the playback.

This completes the first half of the Trax lesson. In the second half of this lesson you work with motion capture data in Trax.

Open the second scene for the lesson

In this second half of this lesson, you work with a second scene file that contains *motion capture data* applied to a skeleton.

Motion capture data is produced by capturing the movement of a real human or animal and digitizing it so it can be applied to a 3D animation character. Motion capture data contains keyframe animation. Motion capture data is useful because it can capture the subtle nuances of motion and gesture that make a character's actions appear life-like. Motion capture data can substantially reduce the work related to posing and keyframing your characters.

- 1 Open the scene named `Trax_Lesson2.mb`.

6 | Animation

Lesson 4 > Open the second scene for the lesson

You can open the scene named `Trax_Lesson2.mb` from the *Maya Documentation, Lessons, and Extras* CD or from the drive where you copied the Getting Started files.

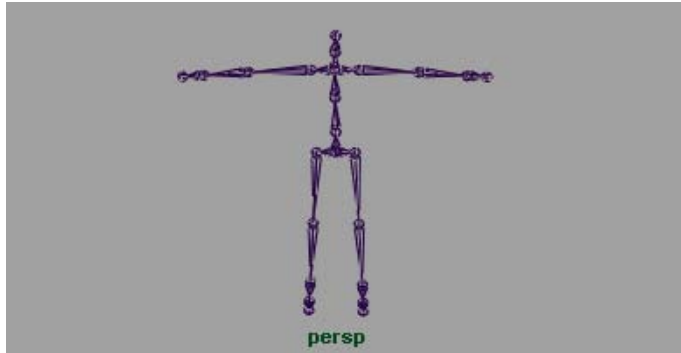

Motion Capture Data courtesy of:
House of Moves Motion Capture Studios

The skeleton appears in the Maya scene in the standard da Vinci pose. In this pose, the character stands straight with its arms extended out to either side. This pose is useful when you need to skin a character, retarget animation from one skeleton to another, or set a rest pose for the skeleton.

In this half of the lesson you learn how to use the Trax Editor to work with motion capture data by extending and redirecting the motion for a character.

Note If you are beginning the lesson from this point, you must first set your panel layouts and display settings for the Trax Editor and Outliner. Refer to "To set a panel layout for use with the Trax Editor" on page 212 and "To set the Outliner to display clips" on page 213.

If your skeleton doesn't appear as shown, you will need to increase the size of the skeleton's joints.

To resize the joints on the skeleton

- 1 From the main menu, select Display > Joint Size > Custom.
The Joint Display Scale window appears.
- 2 Set the Joint Display Scale to 10.
- 3 Close the Joint Display Scale window.

To preview the motion capture animation

- 1 Click play on the Time Slider playback controls to play back the animation.
The skeleton is repositioned and then walks from left to right, stops, and then sits.
- 2 Press stop on the Time Slider's playback control.

Creating clips from motion capture data

When creating a clip from motion capture, it is a good practice to begin by creating a source clip from the entire motion sequence that excludes the Da Vinci pose. You can create the clip and save it to the Visor or Outliner directly without loading it onto a track. You can later revert back to the source clip and load it into a track if necessary.

To create a source clip of the motion capture data

- 1 In the Time Slider, set the Playback Start Time to 1.

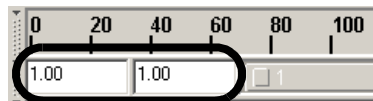

- 2 Press the Go to Start of playback range button to return to frame 1 in the Time Slider.



The skeleton is repositioned at frame 1 where the walking motion begins.

6 | Animation

Lesson 4 > Extending the length of motion capture data

- 3 In the persp view, select the skeleton by click-dragging a bounding box around the skeleton.

The skeleton is highlighted. When the skeleton is selected, many red ticks appear in the Time Slider. The red ticks represent keyframes from the motion capture data.

- 4 In the Trax Editor menu, select Create > Clip > .

The Create Clip Options window appears.

- 5 In the Create Clip Options window, click Edit > Reset Settings to set the tool to its default settings, and then set the following:
 - Type WalkSit in the Name field.
 - Keys - Leave Keys in Timeline: On
 - Put Clip in Visor Only: On
 - Click Create Clip.

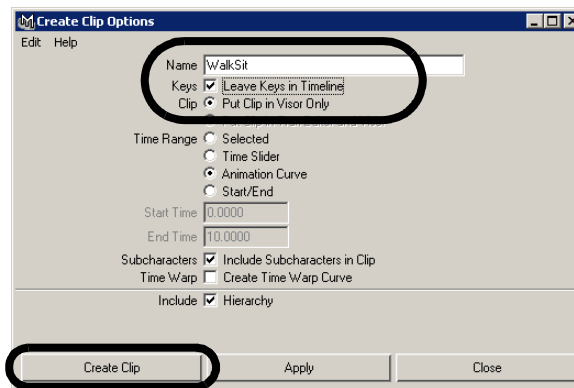

The source clip appears in the Outliner named as WalkSitSource. (If you use the Visor, the clip appears under the Character Clips tab.)

Extending the length of motion capture data

You often need more animation of a motion sequence than is provided in the motion capture data. For example, you may need to have a walk cycle that is substantially longer than what was provided in the original file. You can use the

Trax Editor to edit the motion capture data and create clips that can be *cycled* to make longer animation sequences. When you cycle a clip, the clip is extended in length with duplicate animation from the original clip over a defined interval of time.

If you want to cycle a clip, you must first determine areas within the animation sequence where the clip repeats seamlessly. For example, if you want to create a walk cycle from the motion capture data, you need to determine the time (frame) where the right foot is planted on the ground, and then move forward in the Time Slider, frame by frame, until you find the next frame where the right foot is planted on the ground in exactly the same (or very similar) manner, and then create a clip. The resulting clip will contain two steps of the walking motion. The clip can then be cycled to produce a motion that repeats. How seamlessly it cycles depends on the original motion capture data.

In the steps that follow you create a walk cycle from the motion capture data by:

- Creating a clip from the walking portion of the motion capture sequence that can be repeated.
- Cycle the clip to create a longer walk sequence.

To create a clip that can be cycled

- 1** In the Time Slider, drag the current time indicator to frame 6.
The skeleton updates in the scene to a walking pose where the right foot is planted on the ground.
- 2** Drag the current time indicator forward in the Time Slider until you reach frame 45.
At frame 45, the skeleton is posed in a similar manner as it appeared at frame 6. If you use this range of frames (6 to 45), you can create a clip that can be cycled.
- 3** In the persp view ensure the skeleton is selected.
- 4** In the Trax Editor menu, select Create > Clip > .
The Create Clip Options window appears.
- 5** In the Create Clip Options window, click Edit > Reset Settings to set the tool to its default settings, and then set the following:
 - Type `WalkCycle` in the Name field.

6 | Animation

Lesson 4 > Extending the length of motion capture data

- Put Clip in Trax Editor and Visor: On
- Time Range: Start/End
- Start Time: 6
- End Time: 45
- Click Create Clip

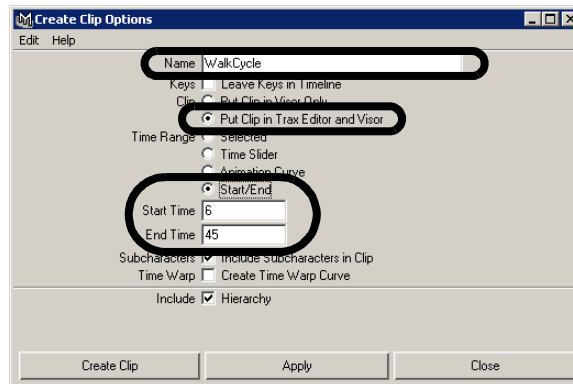

Two clips appear in the Outliner named WalkCycle and WalkCycleSource.

- 6 In the Trax Editor, with the skeleton selected, click the Load Selected Characters icon.



The clip named WalkCycle appears in a new track. Loading the Character displays any tracks associated with the character; in this case the WalkCycle clip.

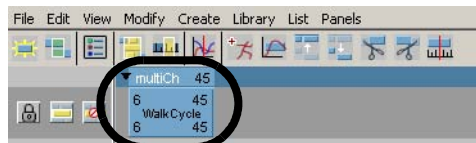

Lesson 4 > Extending the length of motion capture data

- 7** In the Time Slider, set the current time indicator to frame 1.
- 8** Click play on the Time Slider playback controls to play back the clip.
The skeleton takes two steps and stops.

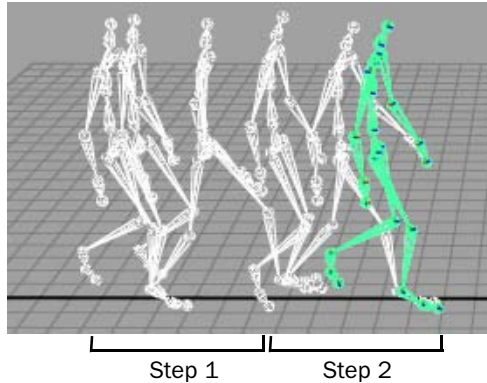

- 9** Press stop on the playback controls to stop the playback and reset the current time indicator to frame 1.
- 10** In the Trax Editor, drag the clip to the left in its track until the Frame In number reads 1.

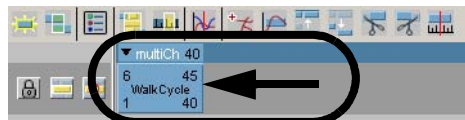

This sets the clip to begin at frame 1 in the Time Slider.

In the steps that follow, you cycle the clip to extend the animation so the skeleton repeats the two step motion and travels farther in the scene.

To cycle the motion for the walk clip

- 1** In the Trax Editor, shift-drag the lower right corner of the Walk clip to the right until a C2.0 number appears in the new region of the clip.
When you shift-drag over the Frame Out area, the mouse cursor changes to a circular pointing arrow to indicate you are cycling the clip.

6 | Animation

Lesson 4 > Extending the length of motion capture data

- 2 Double-click on the cycled clip in the C2 region.

The region is highlighted to indicate you can edit the values in the region. The number will likely not be exactly 2.0. This means that the cycle will not repeat exactly twice.

- 3 Type 2.0 to modify the clip so it cycles exactly twice.

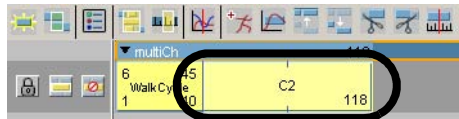

- 4 With the clip selected in the Trax Editor, open the Channel Box and ensure that the WalkCycle clip's Offset channel is set to Relative.

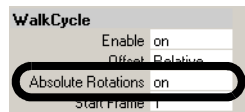

Setting the Offset attribute for the clip to Relative ensures that each cycle begins at the position where the last sequence left off. This ensures that the skeleton doesn't jump back to its start point after each cycle.

- 5 Click play on the Time Slider playback controls to play back the clip.

The skeleton takes six steps and then stops.

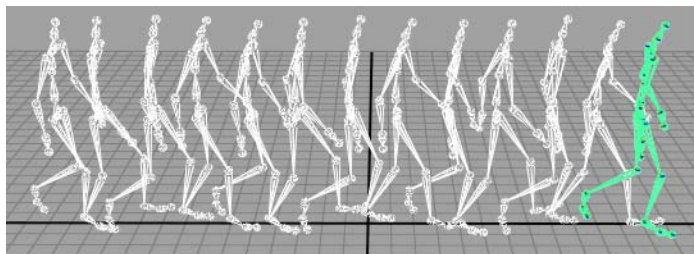

When the clip is cycled twice, the two-step walking motion occurs three times in total.

- 6 Press stop on the playback controls to stop the playback and reset the current time indicator to frame 1.

Redirecting the motion within a clip

Motion capture data can be used in a variety of ways. You can redirect the motion of a character using the same motion capture data. The *Redirect tool* allows you to alter the original animation for a character by modifying its path or orientation at any time during its animation. The Redirect tool does this by offsetting the translation and rotation attributes for the selected character.

For example, you can change the start or end point of a character's animation by redirecting the character's starting position or by redirecting its motion during the animation. You can redirect a character in an existing animation sequence in the scene or a character associated with a clip within the Trax Editor.

In the steps that follow, you redirect the skeleton to turn to the right while walking. The workflow for the redirection is as follows:

- Scrub forward in the animation to determine a location in the clip where you want the character to turn. A realistic choice is where the ball of the skeleton's right foot is planted on the ground plane because this accurately simulates how a real person might turn.
- Select the entire skeleton. In this example, selecting the entire skeleton selects it at the root joint (the top node of the skeleton's hierarchy) Selecting at the root joint ensures that the entire skeleton gets redirected when the redirection control is applied.
- Create and position a rotation redirection control using the Redirect tool.
- Keyframe an initial starting rotation for the redirection control.
- Rotate the redirection control so the skeleton faces the new direction of travel.
- Keyframe the second rotation for the redirection control.

To create a redirection control for the skeleton

- 1 In the Time Slider, drag the current time indicator to frame 36.

6 | Animation

Lesson 4 > Redirecting the motion within a clip

This frame is where the ball of the skeleton's right foot is planted on the ground plane. Use this frame as the location where the skeleton will turn to the right.

- 2 Select the skeleton in the scene view by click-dragging a bounding box around it.
- 3 In the main menu, select Character > Redirect > .
- 4 In the Redirect Options Window set the Redirection Type to Rotation only and then click the Redirect button.

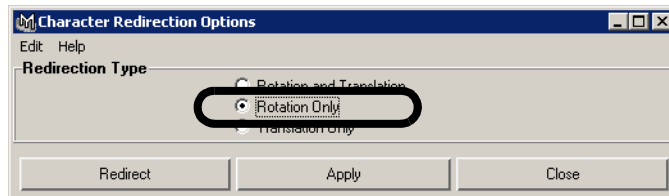

A Rotation redirection control appears between the hips of the skeleton, where the root joint for the skeleton's hierarchy is.

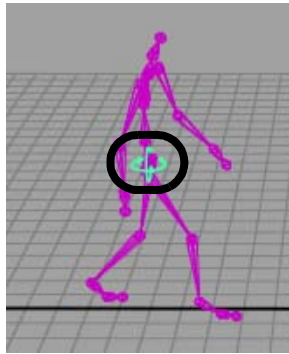

You want the skeleton to pivot (rotate) while standing on the ball of its right foot. To do this, you need to move the redirection control to the ball of the right foot of the skeleton.

To move the redirection control to the ball of the foot

- 1** From the Toolbox, select the Move tool.
The Move tool manipulator appears on the redirect manipulator.
- 2** Press the v key and click-drag the redirection control until it is located on the ball of the right foot as shown below.
Pressing the v key while using the Move Tool momentarily enables the Snap to Points tool.

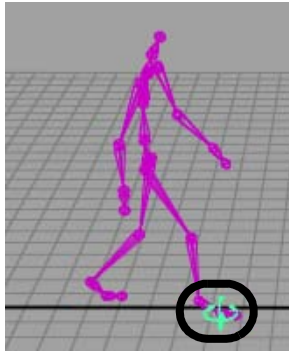

The redirection control is now positioned to redirect the skeleton's walking motion. To complete the redirection process, you need to set keyframes while setting the redirection control so the redirection of the skeleton can occur.

To keyframe the redirection control

- 1** With the redirection control selected, press s to set a keyframe.
A red tick appears in the Time Slider at frame 36 indicating the keyframe. Setting a keyframe establishes the starting rotation for the redirection rotation of the skeleton.
- 2** In the Time Slider, drag the current time indicator to frame 57.
The skeleton updates to a position where its left foot is planted on the ground plane. This is the location where you want the skeleton to be rotated to its new direction of travel.

6 | Animation

Lesson 4 > Redirecting the motion within a clip

- 3 In the Channel Box, with the redirection control still selected, set the Rotate Y attribute to -45.
- 4 Rotate the redirection control approximately -45 degrees about the Y axis until the skeleton is facing in the direction shown below. (You can use the Channel Box values as a guide.)

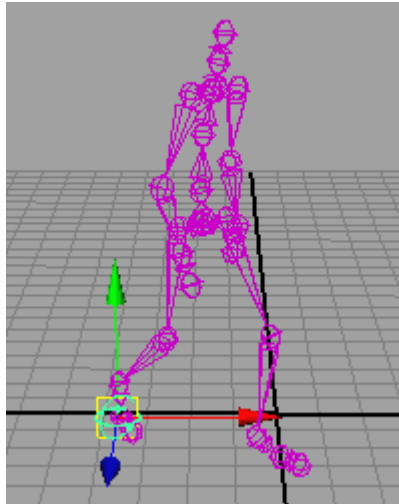

- 5 With the redirection control still selected, press s to set a keyframe. Setting a second keyframe establishes when the redirection rotation for the skeleton ends.
- 6 Set the current time indicator to frame 1.
- 7 Click anywhere in the perspective view to deselect any items in the scene.
- 8 Click play on the Time Slider playback controls to play back the clip. The skeleton takes two steps and then turns to its right after it reaches the redirection control, and continues walking in the new direction of travel and stops when it completes its walk cycle.

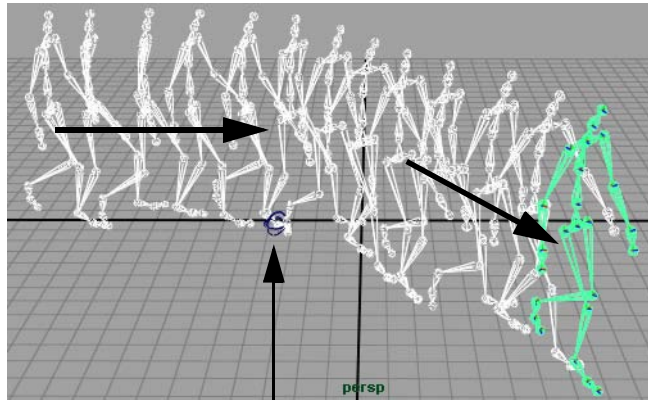

Redirect occurs

- 9 Press stop on the playback controls to stop the playback and reset the current time indicator to frame 1.

Note When redirecting motion within Trax, you may want to consider creating a clip that contains the redirection animation to make it possible to reposition the redirect animation as a clip.

Now that you've redirected the character to a different direction of travel during the walk cycle, you can reuse some of the motion from the original source clip you created earlier in the lesson and saved to the Outliner/Visor.

You insert the source clip from the clip Library in Trax. The clip Library keeps track of the source clips and poses for the current character set. When the source clip is inserted from the Library, a copy of the source clip is created in a new track.

Once you import the source clip and make a copy of it, you trim the duplicate clip to make the character stop walking and then sit in a different location than the original motion capture.

6 | Animation

Lesson 4 > Redirecting the motion within a clip

To insert the source clip

- 1 In the Trax Editor, select Library > Insert Clip. Choose WalkSitSource from the drop-down list.

A duplicate copy of the WalkSitSource clip is created, and inserted onto a new track.

- 2 In the Trax Editor, select View > Frame All.

The track view area updates to display all clips in their entirety.

- 3 In the Trax control area, click the Mute button for the track that contains the WalkCycle clip.



The muted track dims to indicate it is inactive. When the walk cycle track is muted, the character updates to appear in the Da Vinci pose at the origin based on the original source clip.

- 4 Drag the current time indicator to frame 98.

The skeleton updates in the view and the redirection that was applied also occurs. Remember that the redirection occurs for the character, and not the clip.

- 5 Click on the WalkSit clip in the track to select it.

- 6 In the Trax tool bar, click the Trim Clip Before Current Time icon to trim the section of the clip that occurs before frame 98.

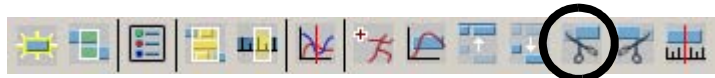

The WalkSit clip is trimmed and the portion of the clip before frame 98 is discarded.

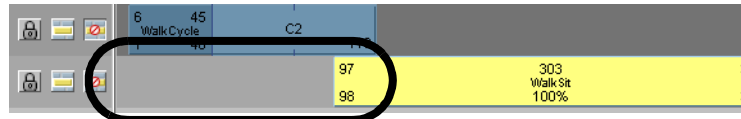

Lesson 4 > Redirecting the motion within a clip

- 7** Click the Mute button again for the track containing the WalkCycle clip to reactivate the track.

The dimmed track becomes active again. The skeleton however has updated to an incorrect pose near its previous position. This occurs because the two active clips overlap, and the character is receiving conflicting positional information as a result. (that is, double translation and rotation information)

- 8** Drag the WalkSit clip to the right in its track until its Frame In number matches the Frame Out for the WalkCycle clip.

The pose for the skeleton is updated to the correct position.

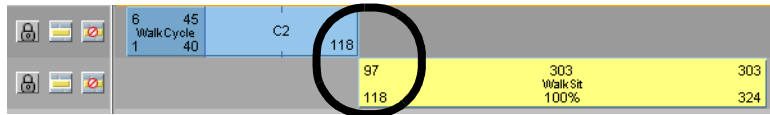

- 9** Reset the current time indicator to frame 1.
- 10** Click play on the Time Slider playback controls to play back the animation.

The skeleton takes two steps and then turns to its right after it reaches the redirection control, and continues walking in the new direction of travel, stops, and then sits.

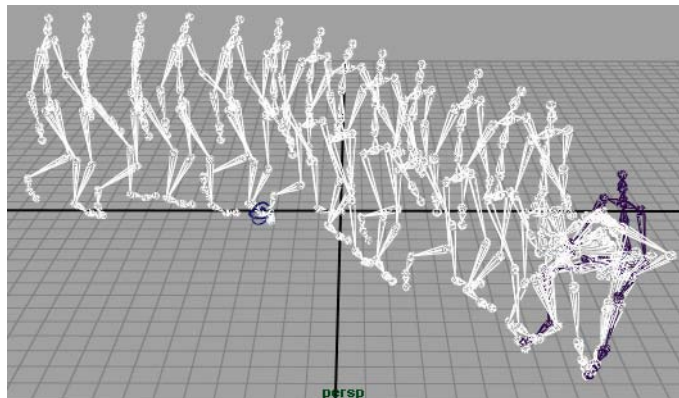

- 11** Press stop on the playback controls to stop the playback and reset the current time indicator to frame 1.

6 | Animation

Lesson 4 > Redirecting the motion within a clip

A small jump cut occurs during the transition between the two clips. The jump cut occurs because the poses for the skeleton do not match from the end of the first clip and the beginning of the second. In your own work, try to anticipate how motion will blend between clips when working in Trax. You can correct the jump cut in this particular example by extending the WalkCycle clip.

To extend the WalkCycle clip to correct the jump cut

- 1 In the Trax Editor, double-click on the WalkCycle clip in the C2 region.
The number becomes highlighted indicating you can edit the number.
- 2 Type 2.2 to edit the clip so it cycles 2.2 times.
The new Frame Out number for the WalkCycle clip becomes 126. It now overlaps in time with the WalkSit clip.

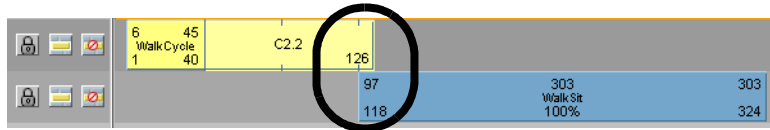

- 3 Drag the WalkSit clip to the right until its Frame In number becomes 126.

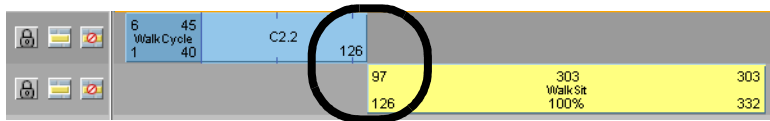

- 4 Click play on the Time Slider's playback control to play back the animation.
The jump cut is less noticeable than before.

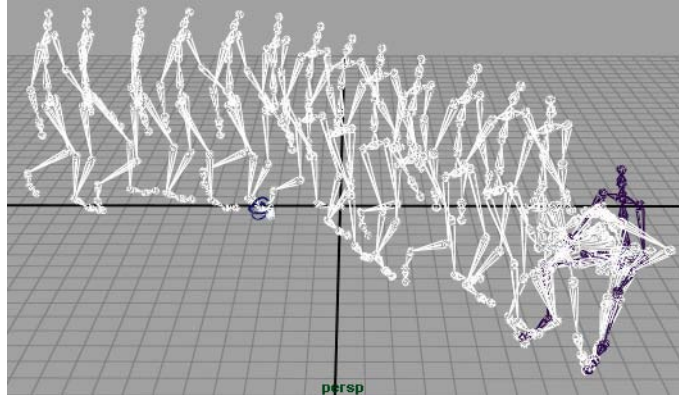

- 5** Press stop on the Time Slider's playback control.
You have completed this lesson. Before leaving this lesson, reset the joint size back to its default setting.

To reset the joint size

- 1** From the main menu, select Display > Joint Size > Custom.
The Joint Display Scale window appears.
- 2** Set the Joint Display Scale to 1.
- 3** Close the Joint Display Scale window.

Beyond the lesson

In this lesson, you learned some fundamental techniques for using the nonlinear animation tools in Trax. You learned how to:

- Key animation sequences for use as nonlinear clips in Trax.
Clips can contain minimal or many animated attributes. You can create clips from existing animation or key animation specifically for use in clips. You should consider what attributes you need represented in a clip when you key the animation before you decide to use nonlinear animation in your work. In this way, a clip can be used to control a specific attribute.

6 | Animation

Lesson 4 > Beyond the lesson

- Create clips from your animation sequences for use in the Trax Editor.

When you create a clip, a character set is created if one does not already exist. You can load and work with multiple character sets in the Trax Editor. To select different character sets when working in Trax you can use the Select Current Character drop-down menu. Clips can also be arranged, scaled, and moved as groups. For more information see *Move clips* and *Track view area* in the Maya Help.

- Use the Trax editor to position, re-arrange, cycle, and scale clips in order to create and modify animation sequences in the scene.

If a character animates or scales in a manner you had not expected when working in Trax, you may want to check to see if the clips overlap or are arranged in a manner that doesn't provide the expected results. In addition, a clip containing motion that is intended to be appended to another clip's motion must have its Offset attribute set to Relative, and Absolute Rotations set to On (in most instances). There are many other tasks you can perform with clips in the Trax Editor that are beyond the scope of this lesson. For more information see *Nonlinear animation components in Trax* in the Maya Help.

- Use the Trax Editor to work with motion capture data.

The Trax Editor is useful when working with motion capture data. Since motion capture data usually contains a lot of keyframe information, the Trax Editor can be useful for creating, modify, and extending the motion data provided. Cycling and redirecting motion are two methods that can be used to get more from your motion capture data. For more information see the section on Motion Capture Animation in the Maya Help.

- Redirect the motion for a character using the Redirect tool.

You can use redirection controls to redirect any type of motion in Maya (Keyframe, motion capture, expressions, dynamics, and so on) For more information and additional examples on redirection see *How do I redirect the motion of an animated character?* in the Maya Help.

- Trim clips in the Trax Editor.

You can trim a clip either before or after the current time indicator discarding the remainder of the clip in the process. You can also split a clip into two parts. The original source clip is not affected. For more information see *Split clips* in the Maya Help.

Blending clips

You can blend the animation between clips. Blends allow you to create smooth transitions and mixes between different motions. A blend can be applied between any two clips that overlap entirely, partially, or not at all. The best results are obtained when blending between similar motions. In some situations, a blend can be used to correct jump cuts. For more information see *Create and edit blends* in the Maya Help.

Key into clip

You can set keyframes to alter the animation within a clip. This process is called Keying into a clip. When you key into a clip, keyframes are placed at the current time on all the animation curves in the selected clip. For more information see *Key into a clip* in the Maya Help.

Time Warps

Time Warps let you change the timing of a clip without modifying the clip's animation curves. You modify the Time Warp by editing the animation curve that controls the warp. Time Warps can also be used to reverse the animation in a clip. For more information see *Create and edit time warps* in the Maya Help.

Visor and Outliner

Both the Visor and Outliner can be used to access clips. The Visor provides a graphical interface to access other resources (clips, poses, shaders, textures, brushes etc.) in your scene. The Outliner displays clips in a textual manner, and is a bit more compact.

Audio clips

You can display and play multiple audio files in Trax allowing you to synchronize your motion clips to specific audio events (sound effects, musical notes, drum beats etc.) in the audio file. Once you import an audio file into Trax, you can then move and rename the audio clip. For more information see *Work with audio* in the Maya Help.

Lesson 5 Inverse kinematics

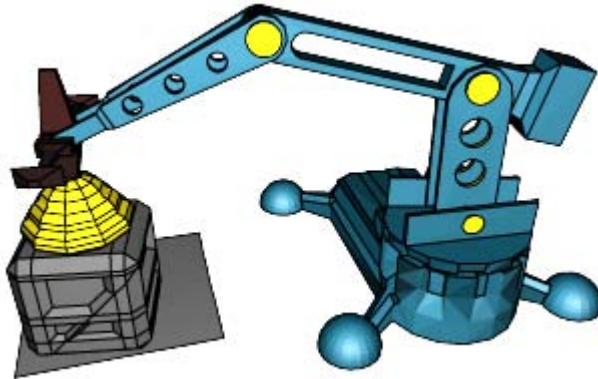

Model created by Rob Ormond

Inverse Kinematics (IK) allows you to efficiently pose your models and characters for animation. You pose the skeleton by positioning IK handles, usually located at the end of an IK joint chain (for example at the hand). The rotations for the other joints are calculated automatically by an *IK solver*. An IK solver calculates the rotations of each joint back up the hierarchy of the joint chain based on the position of the IK handle. See "Creating a skeleton hierarchy" on page 255 for more information on skeletons and joints.

By contrast, Forward Kinematics (FK) requires you to rotate each joint in turn until you have the desired pose for a keyframe. This can be a tedious process when posing a complex skeleton. When using Inverse Kinematics, it's faster to pose a character because the joint rotations further up the hierarchy are calculated automatically based on the placement of the IK Handle. Using both FK and IK techniques on the same skeleton is called FK/IK blending.

IK is obviously useful for posing animated characters that have a skeleton (two-legged, four-legged etc.) and has others applications, such as posing skeletons within mechanical-like models.

The goal of this lesson is to animate a mechanical arm so that it extends into a position over a cargo box, picks up and moves the cargo box to another location, and then sets it down.

As you work through the lesson, you'll learn about many of the basic features related to skeleton hierarchies, IK, and parent constraints. Some initial setup of the model and IK is required so that it can be posed and keyframed to provide a convincing animation.

In this lesson you learn how to:

- Create and use hierarchies to define logical relationships between animatable objects.
- Combine the components of a 3D mechanical arm model into a hierarchical grouping.
- Construct a skeleton for use with IK.
- Combine the skeleton with the mechanical arm model by parenting the components into a hierarchy.
- Create an IK system to allow the skeleton hierarchy to be posed.
- Create a control object to manipulate the IK system.
- Use constraints to control the position and orientation of components within the IK system.
- Limit the range of movement on the IK system.
- Pose and set keyframes for the IK system.
- Animate an object by constraining its motion to two or more objects.

Open the scene for the lesson

In this lesson, you work with a scene we created for your use. In the first steps of this lesson, you open the scene and view the various elements that have been created for your use.

- 1** Make sure you've done the steps in "Preparing for the lessons" on page 165.
- 2** Open the scene named `IK_MechArm.mb`.

6 | Animation

Lesson 5 > Understanding hierarchies

You can open the scene named `IK_MechArm.mb` from the *Maya Documentation, Lessons, and Extras CD* or from the drive where you copied the Getting Started files.

The scene contains a model of a mechanical arm and a cargo box to be moved by the arm. The components of the mechanical arm include:

- A cargo magnet cup on the end
- Three arm segments
- A base for the arm to swivel about
- A four-legged base for the assembly

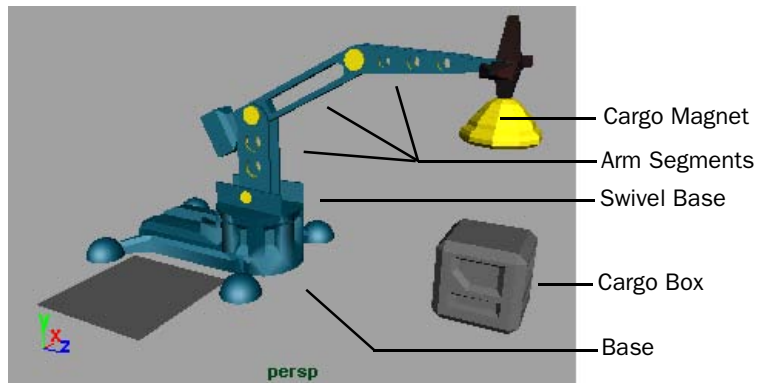

To work with this model using IK you must create a hierarchy for it.

Understanding hierarchies

Inverse Kinematics relies on hierarchical relationships between the components of a model and the IK system to pose and animate the components. Before using Inverse Kinematics it is important to understand hierarchies in Maya.

A hierarchy is composed of a series of nodes that are combined for some purposeful relationship. Individual nodes may represent the surfaces of a model, a network of textures that describe a shading material, or series of joints in a

skeleton. Hierarchies are structured in a top-down manner, with one node at the top (the *parent node* or *root node*) and other nodes (*child nodes* or *leaf nodes*) attached and interconnected beneath the top node.

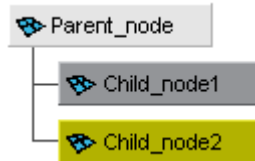

Selecting the parent node at the top of the hierarchy also selects the items contained in the hierarchy below. Selecting a child node lower in the hierarchy selects any child nodes that are lower in the hierarchy.

Hierarchies allow you to create complex structures with relationships between components. For example, when you animate a hierarchical model, you simply need to select and move the parent node of the hierarchy and the rest of the model (child nodes) also moves.

Regardless of whether you decide to animate the mechanical arm using FK or IK, or a combination of both methods on the same model, the best approach involves making the mechanical arm model into a hierarchical structure.

Creating a hierarchy for the mechanical arm ensures that:

- Components of the hierarchy can be rotated as if they were one unit. A common pivot point is created at the parent node level. This allows the separate components to rotate as one unit based on their membership in the hierarchy. For example, if the mechanical arm's base (parent node) is rotated, anything lower down the hierarchy, for example, the mechanical arm which is constructed of child nodes, will also rotate because of its membership and position in the hierarchy.
- When a particular segment of the model is posed and keyframed, the components that are lower in the hierarchy are also posed and keyframed.

6 | Animation

Lesson 5 > Viewing hierarchies using the Hypergraph

Viewing hierarchies using the Hypergraph

In the following steps, you use the *Hypergraph* to view the hierarchy for the mechanical arm. The Hypergraph is a scene management editor that presents a graphical view of the scene hierarchy. It allows you to more easily create, understand, and manage the hierarchy of objects and nodes in your scene.

To view hierarchies using the Hypergraph

- 1 From the perspective view's panel menu, select Panel > Layouts > Two Panes Stacked.

The workspace displays two panels stacked on top of each other with an identical perspective view of the scene.

- 2 In the lower panel, select Panel > Panel > Hypergraph.

The lower panel displays the Hypergraph.

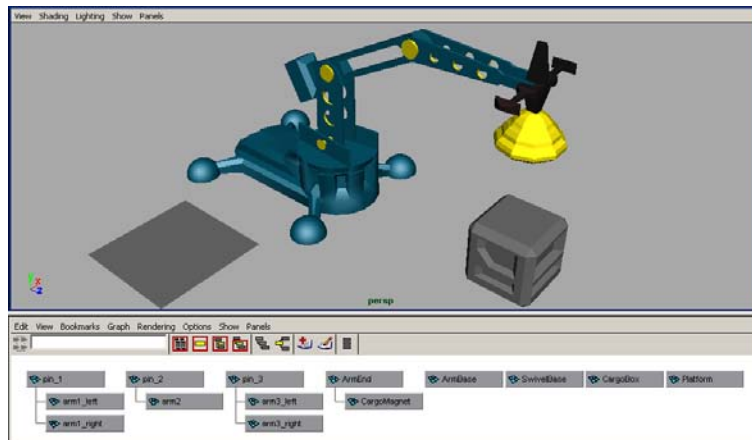

- 3 In the Hypergraph menu, select Graph > Scene Hierarchy.

If the menu item appears dimmed, it indicates that the Hypergraph is already displaying the scene hierarchy.

The Hypergraph displays with a black background by default. In order to see the relationships between the items, the background has been modified for the images in this lesson.

- 4 In the Hypergraph menu, select View > Frame All to see all the components of your scene.

The boxes represent the *nodes* for the various items in the scene. Some items in the scene have already been parented into a hierarchy. This is indicated by the lines connecting some of the nodes. Selecting the nodes in the Hypergraph also selects the item in the scene view.

To select an item using the Hypergraph

- In the Hypergraph, click each of the separate items in the hierarchy at the parent level to select them. At the same time, observe which objects become highlighted on the model in the perspective view.

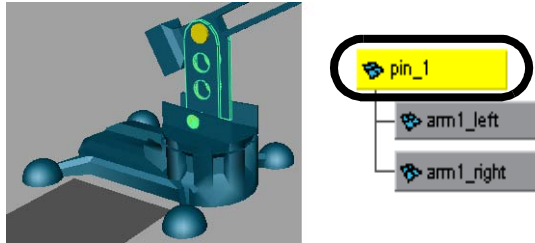

Hierarchies combine the various objects into discrete components for the mechanical arm, that is, the base, lower arm, middle arm, upper arm, etc. If you select and rotate any of the parent nodes in the hierarchies, none of the other arm components follow because they are not combined into one unified hierarchy.

Creating a skeleton hierarchy

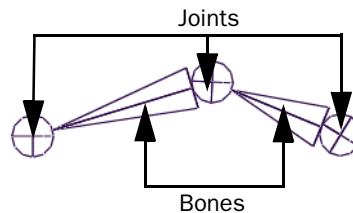

6 | Animation

Lesson 5 > Creating a skeleton hierarchy

To link the various components of the mechanical arm into a hierarchy that can be posed, you need to create a *skeleton*. A skeleton is a hierarchy of *joints* that are connected together with *bones*.

In the scene, a joint represents a special type of node that gets created in a skeleton hierarchy. A joint acts as the parent node for any other joints that occur in the hierarchy below it. Each joint has a rotational pivot point associated with it. A bone is the visual representation used in the scene view to connect the joints and help visualize the joint chain.

A skeleton is similar to a skeleton in the real world in that it acts as the underlying structure for the surfaces to be attached. While you can view the skeleton with its bones and joints in the scene view, it does not appear in your rendered images. Its purpose is to assist you in setting up and posing your models and characters and to visualize the motion you want to achieve.

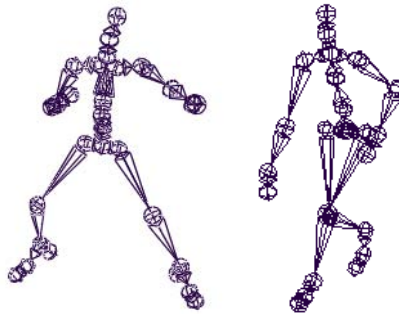

Skeletons are integral to the animation of any character or hierarchical model. Examples of characters that use skeletons are two and four legged animals. Skeletons are also useful for animating other organic components such as the tail of an animal, a tentacle of an octopus, or a snake.

In the following steps, you create a simple skeleton consisting of four joints that you combine with the mechanical arm model into a skeleton hierarchy, allowing you to pose and animate the model.

To create a skeleton for the mechanical arm

- 1 In the perspective view menu, select Panels > Orthographic > side.
The view updates to display the side view.

You need to view the components of the mechanical arm fully in the side view so you can draw the joints for the skeleton.

- 2 Resize the side view to a larger size by dragging the border between the side and Hypergraph panel views downwards.
- 3 In the side view menu, select Shading > Wireframe (Hotkey 4).

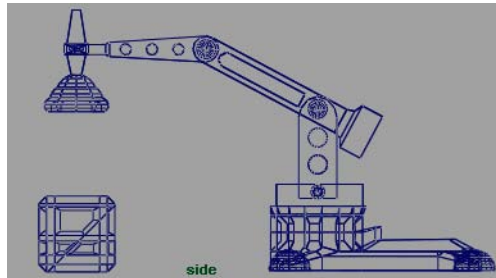

- 4 From the main menu, select Skeleton > Joint Tool > . The Tool Settings window for the Joint Tool appears. The Joint Tool is used to create the joints and bones for a skeleton.
- 5 In the Joint Tool settings window, do the following:
 - Click Reset Tool to set the tool to its default settings.

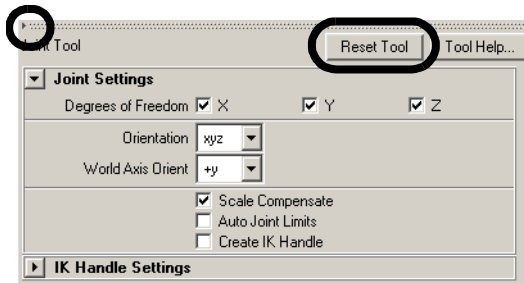

- Hide the Tool Settings window by clicking the right-pointing arrow that is located in the upper left corner of the Tool Settings window.
- 6 In the side view, starting from the base of the mechanical arm, do the following:

6 | Animation

Lesson 5 > Creating a skeleton hierarchy

- Click in the center of each pivot pin on the mechanical arm to place four joints as shown in the image below.

Try to click as close to the center of each pivot pin as you can, as the rotation of the joints on the model will be based on the location of the joints on the skeleton. As you place the joints, a bone appears, connecting each joint. (Because the model lies along the YZ plane, the joints are created close to the center of each corresponding joint on the mechanical arm model.)

- After you place the fourth joint, press Enter to indicate that the last joint has been placed.

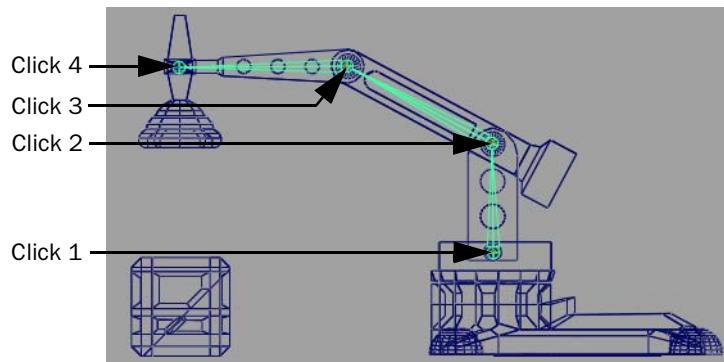

- 7 In the Hypergraph, dolly the view to see the skeleton node hierarchy you just created. (It appears at the right side of the view.)

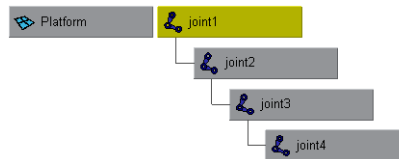

- 8 In the Hypergraph, select the joint1 node.
The entire skeleton becomes selected. Any rotations on this node also affect anything lower down the hierarchy.

- 9 Select joint2 (You can also press the down arrow on your keyboard to select further down the hierarchy).

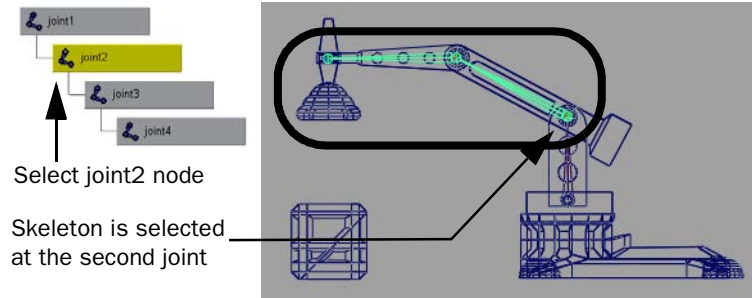

The skeleton is selected from joint2 downwards in the hierarchy. Any rotations that you make on this node affect only joint2 and nodes below joint2.

Once a skeletal hierarchy is created, the various surface components can be added to the hierarchy.

Parenting a model into a skeleton hierarchy

Parenting is the term used when placing a node beneath another in a hierarchy so it becomes the child of the node above it (its parent) in the hierarchy.

In the following steps, you add the surfaces of the mechanical arm model into the skeleton hierarchy. This process links the models' surfaces to the skeleton hierarchy making it possible to pose and animate the model like a real mechanical arm. Using the Hypergraph to select the nodes allows you to better visualize the process and the hierarchical relationships that result.

6 | Animation

Lesson 5 > Parenting a model into a skeleton hierarchy

Note The following parenting procedure works well for the mechanical arm (no organic bending or deformation occurs) and provides one technique for adding modeled objects to a skeletal hierarchy.

A more common technique for combining a character model into a skeleton hierarchy is referred to as *skinning* or *binding*. The Bind Skin tool combines the surface components and joints together into a hierarchy and also takes into account any deformations that may occur when a character bends or flexes (knees, waist, neck, elbows etc.). Maya provides a few methods for skinning. For more information see *Skeletons and skinning* in the Maya Help. For a tutorial on skinning see "Smooth skinning" on page 311.

To parent the mechanical arm into the skeleton

- 1** In the Hypergraph menu, select View > Frame All.
The Hypergraph displays all the nodes for the scene.
- 2** In the Hypergraph, select the node named ArmEnd and then shift-select the node named joint4.
The order of selection is important. You want to select the child node first, and then shift-select the item that will become the parent node second.
- 3** In the main menu, select Edit > Parent (Hotkey p).
In the Hypergraph, joint4 is now the parent node for the Arm_end node in the skeleton hierarchy.
- 4** Repeat the parenting process for the following items:
 - pin3 is parented under joint3
 - pin2 is parented under joint2
 - pin1 is parented under joint1Your new hierarchy should appear as shown in the diagram below.

6 | Animation

Lesson 5 > Parenting a model into a skeleton hierarchy

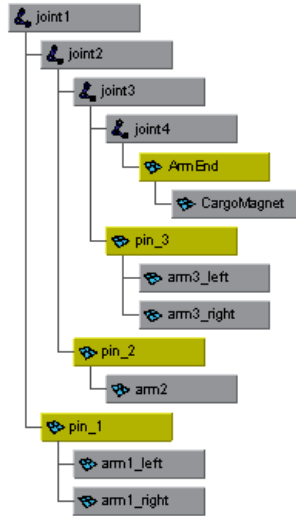

In the next steps, SwivelBase becomes the parent node for the new hierarchy so that the entire arm assembly swivels about the center of the base component.

- 5** In the Hypergraph, select the node named joint1 and then shift-select the node named SwivelBase.
- 6** In the main menu, select Edit > Parent (Hotkey p).
Change the panel display to a layout that allows you to view the hierarchy in the Hypergraph.
- 7** In the side view menu, select Panels > Layouts > Two panes side by side.
The panels display in a side by side configuration.
- 8** Dolly the Hypergraph view as required to view the new hierarchy.

6 | Animation

Lesson 5 > Parenting a model into a skeleton hierarchy

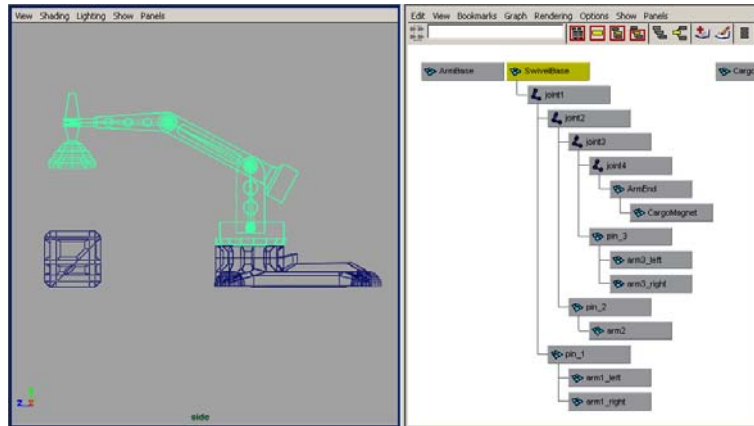

- 9** In the Hypergraph, select the node named Swivel_base.

In the side view, observe that both the mechanical arm model and the skeleton are selected. Swivel_base is the parent or root node for the hierarchy. If you rotate SwivelBase, everything else below that node (the entire arm with skeleton) rotates.

- 10** Select the node named joint3.

Observe that the last two components of the mechanical arm are selected. If you rotate joint3, only the components below that node in the hierarchy will be affected.

- 11** Select the node named pin2.

Observe that only one isolated segment of the model is selected. No other components or joints are selected when pin2 node is selected. If you rotate the model at pin2, only the component at pin2 will rotate in isolation from the rest of the hierarchy because it is located lower in the hierarchy.

It is now possible to select and rotate the skeleton joints to pose the mechanical arm as a unit, and then set keyframes to animate it. Posing a character using joint rotations is referred to as Forward Kinematics (FK). FK allows for precise control when setting up a pose, but it can be a time consuming process to select and rotate each joint into the desired position.

When an animation is more focused on the goal of placing the end joint in a hierarchy in a particular position, (for example, a hand or a foot), it is more efficient to use Inverse Kinematics to pose the skeleton. For more information on forward and inverse kinematics, see *Posing skeletons* in the Maya Help.

Note It's not a simple matter to state that one technique or another is the only approach to achieving a desired result when animating in Maya. You must decide whether a particular technique works for a particular scenario based on the options it provides. A combination of animation techniques can be creatively used in a variety of ways.

Applying IK to a skeleton hierarchy

IK allows you to control the joint rotations in a skeleton using an *IK handle*. You pose the skeleton by positioning the IK handle (usually located at the end extremity of the skeleton) and having the rotations for the other joints calculated automatically by the *IK solver*. In the steps that follow, you apply IK to the skeletal hierarchy.

To create an IK handle for the mechanical arm

- 1 From the main menu, select Skeleton > IK Handle Tool > .

The IK Handle Tool Settings window for the Joint Tool appears. When the mouse pointer is in the orthographic view its appearance changes to the tool's cross hair cursor.



- 2 In the IK Handle Tool settings window, do the following:
 - Click Reset Tool to set the tool to its default settings.
 - Set the IK Handle Settings: Current Solver - ikSCsolver.

6 | Animation

Lesson 5 > Applying IK to a skeleton hierarchy

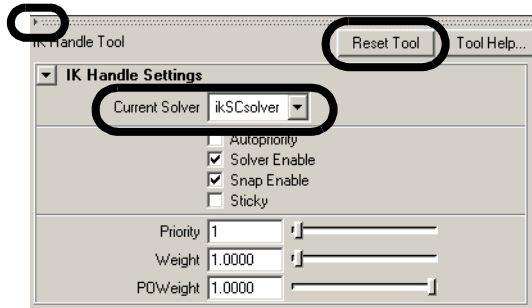

- Hide the Tool Settings window by clicking the right-pointing arrow that is located in the upper left corner of the Tool Settings window.

The ikSCsolver setting selects the IK Single Chain Solver. This solver ensures that the joints in the skeleton will lie along a single plane. This solver is well suited for the mechanical arm, because the arm doesn't need to twist unlike a real arm.

- 3** Working in the side view, starting from the base of the mechanical arm, do the following:
 - Click on the skeleton joint at the base of the mechanical arm.
 - Click on the skeleton joint at the tip of the mechanical arm. (The IK Tool is designed to attach to the joints closest to your selection point.)

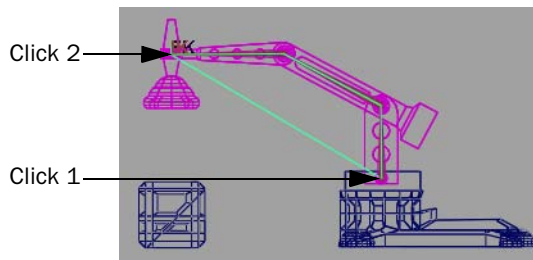

In the side view, the IK handle is drawn as a line from the start and end joints of the IK chain.

- 4** In the Hypergraph menu, select View > Frame All.

In the Hypergraph, two new nodes appear in the hierarchy that represent the IK chain: an IK Handle node and an end effector node.

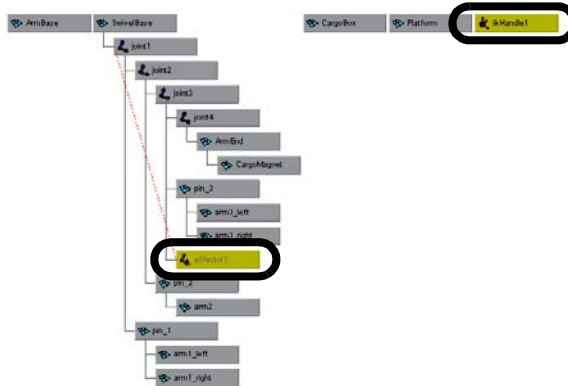

- 5 In the Hypergraph, select the node named ikHandle1.
The IK Handle (in combination with the end effector) is used by the IK solver to calculate the rotation of the joints in the IK chain. By default, the IK Handle is located at the last joint of the IK chain in the scene view.
- 6 Select the Move Tool from the Toolbox, and drag the Move Tool's X axis manipulator (blue arrow) to reposition the mechanical arm.
When you drag the manipulator, the skeleton and mechanical arm model are repositioned.
- 7 Reset the mechanical arm to its previous position by selecting Edit > Undo until the mechanical arm is positioned into its previous orientation.

Note When using the Undo feature, do not undo so many times you inadvertently undo the IK handle you've just created.

The next steps describe how to manipulate the IK Handle using a control object.

6 | Animation

Lesson 5 > Creating a control object for an IK system

Creating a control object for an IK system

Using the IK Handle to pose an IK chain is generally not a good practice. The IK Handle can be challenging to select in the scene view, especially when it's grouped into a hierarchy that includes a skeleton and other surface components. A better practice is to create a *control object*.

You create a control object to select and manipulate an IK system instead of directly using the IK Handle. You can create a control object with a curve or a locator, which are often used because they don't appear in the rendered image.

The control object controls the movement of the IK Handle using a *constraint*. You can constrain the position, orientation, or scale of an object to other objects using constraints.

To create a control object:

- Create and position the control object in the scene view.
- Name the node for the control object in the Hypergraph.
- Freeze transformations for the control object.
- Label the control object in the scene view.
- Constrain the IK Handle to the control object.

To create a control object using a locator

- 1** From the main menu, select Create > Locator.
A three-dimensional cross is created at the origin in the scene view.
- 2** Select the Move Tool from the Toolbox.
- 3** In the side view, reposition the locator slightly above and in front of the end of the mechanical arm as shown in the image below.

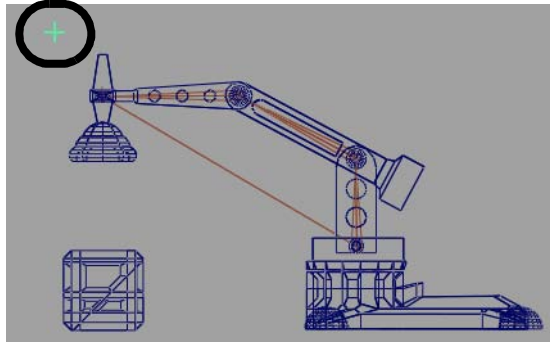

To easily identify the locator as a control object in the Hypergraph, rename the locator.

To rename the control object using the Hypergraph

- 1 In the Hypergraph, right-click the node named locator1. Choose Rename from the pop-up menu that appears.
The locator1 name is highlighted on the node.
- 2 Type the name ArmControl and press Enter to save the name for the locator.



Before you constrain the IK handle to the control object, you need to freeze the transformations for the control object. *Freeze Transformations* zeros the transformations for an object without changing the position of the object. This is another good practice; if it becomes necessary to reset the arm to its default position, you can set the transformation on the control object to zero, and the arm will return to this default pose.

To freeze the transformations for the control object

- 1 In the Hypergraph, select the node named ArmControl.
The control object is selected in the scene view.
- 2 In the main menu, select Modify > Freeze Transformations > .

6 | Animation

Lesson 5 > Creating a control object for an IK system

- 3 In the Freeze Transformation Options window do the following:
 - Select Edit > Reset Settings to set the tool to its default settings.
 - Click the Freeze Transform button.

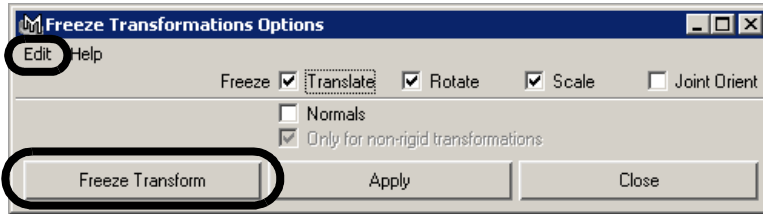

The transformations for ArmControl are set to zero. From this point onwards, you can reset its position to this location by zeroing its translations in the Channel Box.

To easily identify the locator as the control object in the scene view, label the control object using an *annotation*. An annotation is a text label that can be set to point at the labeled item. Annotations are useful because they always face the viewer, regardless of the orientation of the model in the scene view.

To label the control object in the scene view

- 1 In the Hypergraph, select the ArmControl node.
- 2 In the main menu, select Create > Annotation.
A input window appears.
- 3 Type `ArmControl` and click OK.

In the scene view, the word *ArmControl* appears near the locator/control object. In the Hypergraph, two new nodes appear in a hierarchy beneath ArmControl.

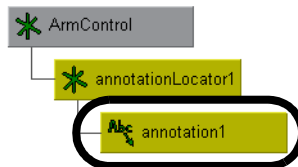

- 4 With the annotation still selected, select the Move Tool.
- 5 In the side view, drag only the annotation so it appears slightly offset from the locator object as shown below.

The annotation displays in any scene view so you can easily identify the control object for selection.

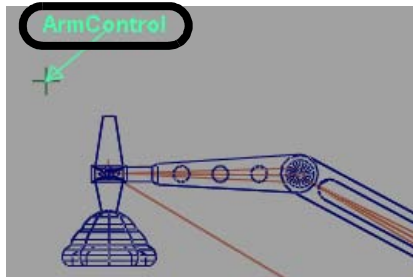

To simplify the display of the Arm Control node

- 1 In the Hypergraph, right-click the ArmControl node. Choose Collapse from the pop-up menu. (You can also double-click a node to collapse or expand the hierarchy below it.)

The ArmControl node appears as a single node instead of the previous three node hierarchy. The small arrowhead on the lower left-hand corner of the node indicates that the node is collapsed.



The control object must be linked to the IK Handle to control the IK Handle.

Constraining an IK system

You can constrain the IK Handle to the control object (ArmControl) using a *point constraint*. A point constraint allows the transformation attributes of one object to be controlled by the transformations of another object. For example, you select and position ArmControl without having to touch the IK Handle. You also set the

6 | Animation

Lesson 5 > Constraining an IK system

constraint so ArmControl maintains the current distance (*offset*) from the IK Handle. The offset ensures that the constrained IK handle doesn't move to the same position as the control object.

To constrain the IK Handle to the control object

- 1 In the Hypergraph, select the ArmControl node and then shift select the ikHandle1 node.
The order of selection when applying a constraint is important: you must select the constraining object first, and the item to be constrained second.
- 2 In the main menu, select Constrain > Point > .
The Point Constraint Options window appears.
- 3 In the Point Constraint Options window, do the following:
 - Select Edit > Reset Settings to set the tool to its default settings.
 - Turn on the Maintain Offset setting.
 - Click the Add button.

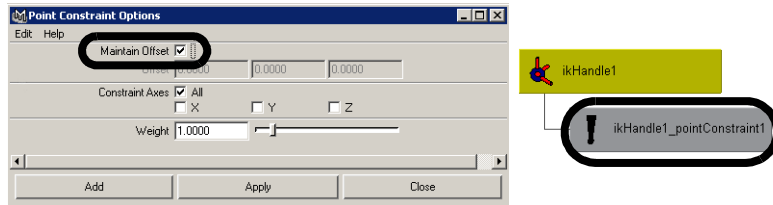

The IK handle is constrained to the control object. In the Hypergraph, a constraint node is created beneath the ikHandle1 node.

- 4 In the Hypergraph, select only the ArmControl node.
- 5 In the Toolbox, select the Move Tool.
- 6 In the side view, drag the manipulator to reposition the control object. (Experiment with a few different positions in the side view only.)

When you drag the manipulator, the control object moves, which in turn moves the IKHandle. Because the IK handle controls the skeleton and the mechanical arm model, they also move. The offset between the control object and the IK Handle is maintained.

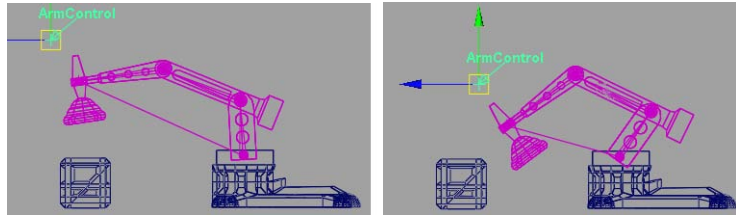

The Cargo Magnet does not continuously point downwards when rotated. Its orientation is based on the original rotation it had in its original position.

The mechanical arm will be easier to pose if you set Cargo Magnet to be oriented downwards towards the floor of the scene regardless of the orientation of the other components of the arm.

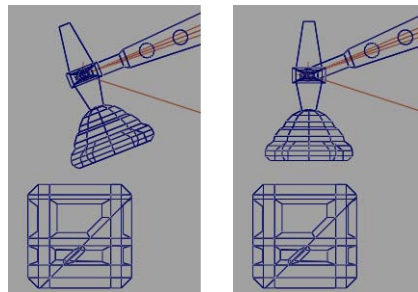

Incorrect

Correct

You make CargoMagnet point downwards using an *orient constraint*. An orient constraint constrains the orientation (rotation) of the X, Y, and Z axes of one object to match those of the constraining (target) object.

In the next steps, you reset the position of the mechanical arm to its default position, and then apply an orient constraint to the last joint in the IK system so that its orientation matches the control object. The effect is that CargoMagnet points downwards regardless of any other movement in the scene.

To set the IK system to its default position

- 1 In the Hypergraph, select the ArmControl node.

6 | Animation

Lesson 5 > Constraining an IK system

- 2 Open the Channel Box by clicking the Show/Hide Channel Box icon.



- 3 In the Channel Box, set the X, Y, and Z transformations for ArmControl to 0. Zeroing the transformations on ArmControl resets the mechanical arm to its home position because of the freeze transformations step you performed in the previous section.
- 4 Close the Channel Box by clicking the Show/Hide Channel Box icon.

To apply an orient constraint for the IK system

- 1 In the Hypergraph menu, select View > Frame All.
The Hypergraph displays all the nodes in the scene.
- 2 In the Hypergraph, select ArmControl and then shift-select the node named joint4. (You may need to dolly and track the Hypergraph view to view these nodes.)
- 3 In the Main Menu bar, select Constrain > Orient > .
- 4 In the Orient Constraint Options window, do the following:
 - Select Edit > Reset Settings to set the tool to the default settings.
 - Click the Add button.

Joint4 is constrained to have the same orientation as the control object. In the Hypergraph, the constraint node is created below the joint4 node in the hierarchy.

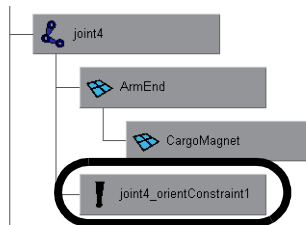

- 5 With only the ArmControl node selected, use the Move Tool to reposition ArmControl in the side view.

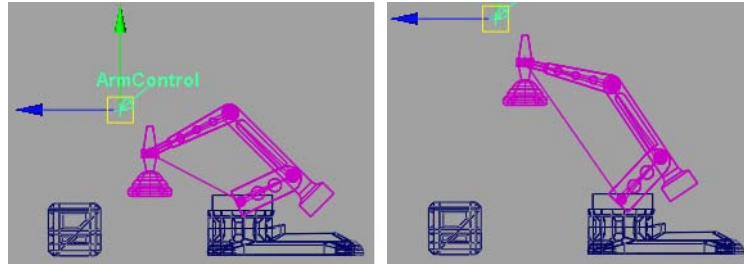

CargoMagnet maintains an orientation facing the floor of the scene regardless of how the mechanical arm is positioned in the side view.

In the next section, you learn how to limit the range of movement for the IK system.

Limiting the range of motion of an IK system

It's possible to move ArmControl so that the mechanical arm fully extends to a straight position or orients itself to other positions that you don't necessarily want.

You can limit the range of motion of the arm to ensure that the IK system poses in a predictable manner. In the following section, you limit the motion for the IK system as follows:

- Lock the translation of the control object (ArmControl) so that it can only move in Y and Z. By locking the X channel so it cannot be selected or modified, the arm will not be able to move from side to side.
- Lock the rotations on the swiveling base for the arm so it only rotates about its Y axis, and not about its X or Z axes.
- Limit the translations for the Arm Control so the mechanical arm cannot fully extend to a straightened position.

To lock the Translate X channel for ArmControl

- 1** In the Hypergraph, select the ArmControl node.
- 2** Open the Channel Box to view the transform channels for ArmControl.

6 | Animation

Lesson 5 > Limiting the range of motion of an IK system

- 3 Set all Translate or Rotate channels to 0, if they are not already.
- 4 In the Channel Box, select the Translate X channel by clicking on its name.

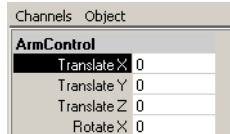

- 5 Right click on the word Translate X.
A drop-down menu appears.
- 6 From the drop-down menu, choose Lock Selected.

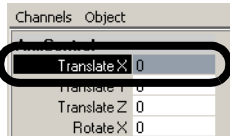

The numerical field for Translate X is dimmed indicating that the channel is locked. If you try to move ArmControl in X, it will not be possible unless you unlock the Translate X channel.

To lock the Rotate X and Z channels for SwivelBase

- 1 In the Hypergraph, select only the SwivelBase node.
- 2 Open the Channel Box to view the rotation channels for SwivelBase.
- 3 Set all Translate or Rotate channels to 0, if they are not already.
- 4 In the Channel Box, select the Rotate X and Rotate Z channels by control-clicking on their names.
- 5 Right click on either of the selected names.
A drop-down menu appears.
- 6 From the drop-down menu, select Lock Selected.

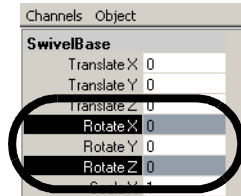

To confirm that the Rotate X & Z channels are locked

- 1 In the Hypergraph, ensure only the SwivelBase node is selected.
- 2 In the view, select Panels > Orthographic > top.
- 3 In the view, select Shading > Smooth Shade All.
- 4 Dolly the top view so you can fully view the mechanical arm as shown below.
- 5 Using the ChannelBox, rotate SwivelBase by typing 45 in the Rotate Y channel and pressing Enter.

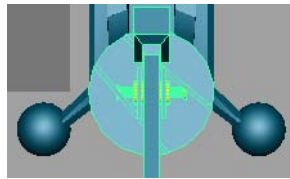

Rotated like this

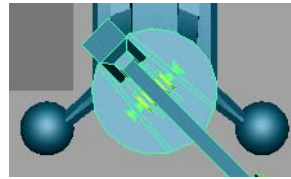

Expected it to rotate like this

SwivelBase rotates in the view but the mechanical arm does not rotate. You first might think something is wrong because SwivelBase and all of the arm's skeletons and surfaces are parented into the same hierarchy.

Note You may sometimes discover that something doesn't work in the manner you originally anticipated when setting up an IK system. When this occurs, it's useful to stop and diagnose why something is working the way it is (or not working the way it should). In that way you can retrace your actions to determine where the problem resides.

6 | Animation

Lesson 5 > Limiting the range of motion of an IK system

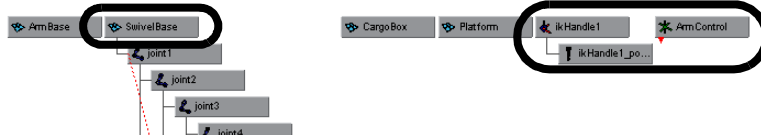

ArmControl and IK Handle are not parented into the SwivelBase hierarchy. Because ArmControl and IK Handle control the movements of the mechanical arm, they must be parented into the SwivelBase hierarchy in order for the arm to rotate when SwivelBase is rotated.

To parent the IK Handle into the skeleton hierarchy

- 1** In the Hypergraph, select the SwivelBase node.
- 2** In the ChannelBox, reset the Rotate Y channel for SwivelBase to 0.
Setting any previous transformations to zero is necessary before parenting the IK Handle beneath SwivelBase in the hierarchy.
- 3** Unselect the SwivelBase node before performing the following steps.
- 4** In the Hypergraph menu, select View > Frame All.
The Hypergraph displays all the nodes for the scene.
- 5** In the Hypergraph, shift-select the nodes named ikHandle1, ArmControl, and SwivelBase.
The order of selection is important. You want to shift-select the items that will be the child nodes first, and then shift-select the item that will be the parent node last.
- 6** In the main menu, select Edit > Parent (Hotkey p).
In the Hypergraph, IKHandle and ArmControl are now child nodes for the SwivelBase node in the skeleton hierarchy.

Lesson 5 > Limiting the range of motion of an IK system

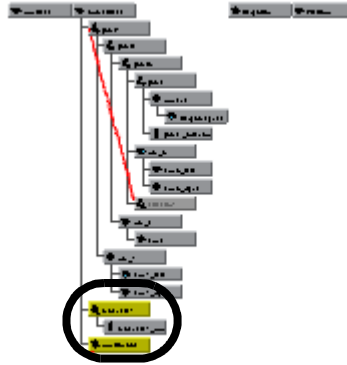

- 7** In the Hypergraph, select only SwivelBase.
- 8** Using the ChannelBox, set Rotate Y for SwivelBase to 45.

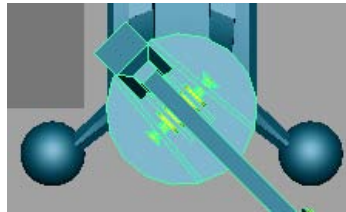

When SwivelBase is rotated, the mechanical arm rotates because of its relationship within the hierarchy.

- 9** Reset the Rotate Y value for SwivelBase back to 0.

Finally, you want to limit how far Arm Control can translate away from the base of the model so the arm does not extend to a fully straightened position.

To determine the settings for the translation limits you need to examine the position of the mechanical arm in various positions while simultaneously viewing the translation values in the ChannelBox.

To determine translation limits for the Arm Control

- 1** In the Hypergraph, select ArmControl.

6 | Animation

Lesson 5 > Limiting the range of motion of an IK system

- 2 Ensure the Channel Box is open so you can view the translate channels for ArmControl.
- 3 In the view, select Panels > Orthographic > side.
- 4 Dolly the side view so you can fully view the mechanical arm.
- 5 Select the Move Tool.
- 6 In the side view, press the middle mouse button and drag the mouse diagonally until the mechanical arm is fully extended as shown below.

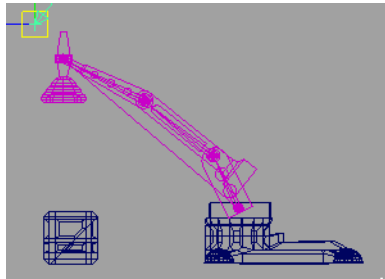

- 7 In the Channel Box, observe the number that displays in the Translate Y and Z channels.
When the arm is diagonally articulated above the cargo box, it is almost fully extended when the translation values are roughly as follows:
 - Translate Y: 7.5
 - Translate Z: 1
- 8 In the side view, press the middle mouse button and drag the mouse in a diagonally until the mechanical arm is almost fully compressed as shown below.

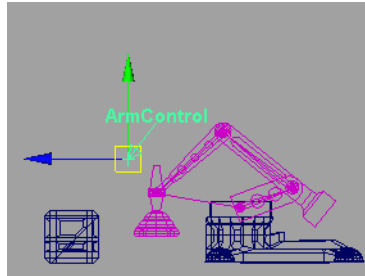

- 9** In the Channel Box, observe the numbers that display in the Translate Y and Z channels.

When the arm is articulated to a compressed pose, the translation values are roughly as follows:

- Translate Y: -13
- Translate Z: -13

These minimum and maximum values will be used in the steps that follow as the minimum and maximum translation limits for the ArmControl.

To set translation limits for the Arm Control

- 1** In the Hypergraph, select the ArmControl node.
- 2** Open the Attribute Editor (Window > Attribute Editor or click on the Show/Hide Attribute Editor icon on the Status Line).



The Attribute Editor displays the nodes associated with Arm Control.

- 3** In the Attribute Editor, click the ArmControl tab.
If the ArmControl tab is not visible, use the left and right scrolls arrows to scroll the view sideways to view it.

6 | Animation

Lesson 5 > Limiting the range of motion of an IK system

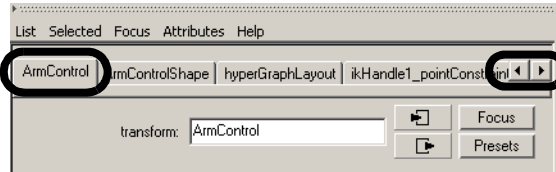

- 4 In the Attribute Editor, expand the Limit Information attributes, and then the Translate attributes.

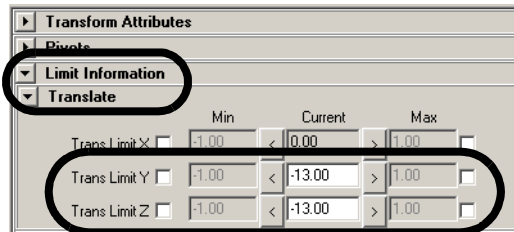

- 5 In the Translate attributes, click the Trans Limit Y and Z check boxes to undim the numerical boxes and then set the following values:
 - Trans Limit Y (Min): -13
 - Trans Limit Y (Max): 7.5
 - Trans Limit Z (Min): -13
 - Trans Limit Z (Max): 1

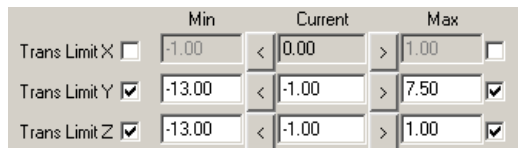

- 6 Hide the Attribute Editor.
- 7 Select ArmControl.
- 8 In the side view, move ArmControl to test the range of movement for the IK system.

The mechanical arm moves with a limited range of motion.

Simplifying the display of a hierarchy

The number of nodes in the IK system's hierarchy at this point may appear a bit overwhelming, but it allows the posing of the mechanical arm to be efficient and effective. You can simplify the display of the nodes by collapsing portions of the hierarchy.

To collapse the display of the hierarchy

- 1 In the Hypergraph, right-click on joint1, and choose Collapse from the pop-up menu.

The child nodes below joint1 disappear simplifying the display of the hierarchy. The small arrowhead on the corner of the joint1 node indicates that a hierarchy exists below joint1. If you later need to view or select these nodes you can expand them again.

- 2 Collapse the ArmControl and IKHandle nodes.

The display of the hierarchy is simplified as shown below.



The IK system is now rigged and ready for animation.

Applying parent constraints on an IK system

To animate the cargo box so that it is picked up by the mechanical arm you need a method of constraining the cargo box to the mechanical arm so that it moves with the arm at specific times in the animation. This is accomplished using a *parent constraint*.

When a parent constraint is applied to an object, the constrained object behaves as if it were a child node of the constraining object.

6 | Animation

Lesson 5 > Applying parent constraints on an IK system

An object can have multiple constraints applied to it. The influence each constraint has on the object can be changed by modifying the weight attribute for the parent constraint. The weight attribute is an animatable parameter and can be set to be on or off at specific frames.

In this lesson, the cargo box is constrained to both the ArmControl and the Platform on the floor. By animating the weight attributes for these two parent constraints, the cargo box will move from one location to another depending on which constraint is influencing it at specific times in the animation.

To set up the parent constraints you need to position the constrained object at the locations where the influence will begin or end, and then set the parent constraints.

To set parent constraints for the cargo box

- 1 In the side view menu, select Shading > Smooth Shade All.
- 2 In the side view menu, select Panels > Perspective > persp.
- 3 In the Hypergraph, select ArmControl.
- 4 In the ChannelBox, set the Translate Y and Z values as follows:
 - Translate Y: -9
 - Translate Z: 0

The arm is repositioned so that the cargo magnet is directly above the cargo box as shown below. Track, tumble, or dolly the view if required so you can see the mechanical arm unobstructed.

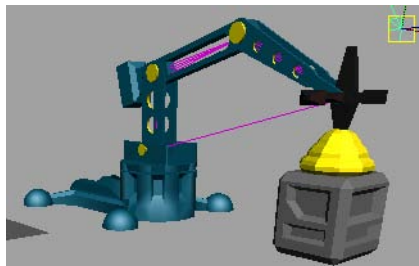

ArmControl	
Translate X	0
Translate Y	-9
Translate Z	0

- 5 In the Hypergraph, with ArmControl still selected, shift-select the CargoBox node.

Lesson 5 > Applying parent constraints on an IK system

The order of selection is important when you apply constraints. You must select the constraining object first, and the item to be constrained second.

- 6** In the main menu, select **Constrain > Parent > **.
- 7** In the Parent Constraint Options window, do the following:
 - Select **Edit > Reset Settings** to set the tool to its default settings.
 - Click the **Add** button.

CargoBox is constrained to ControlArm. A new constraint node has been created below the CargoBox node in the Hypergraph. If you reposition the mechanical arm, CargoBox moves with it because of the constraint that is now applied.

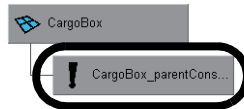

- 8** In the Hypergraph, select only SwivelBase.
- 9** In the ChannelBox, set the Rotate Y value for SwivelBase as follows:
 - Rotate Y: -100

The mechanical arm and the cargo box are positioned as shown below.

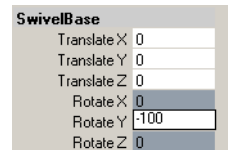
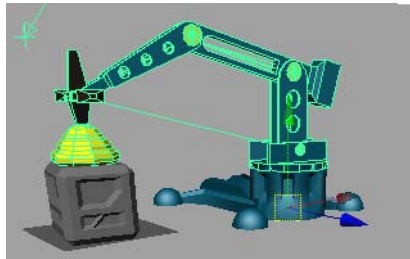

- 10** In the Hypergraph, select Platform and then shift-select the CargoBox node.
- 11** In the main menu, select **Constrain > Parent**.
CargoBox is constrained to Platform. This is the second constraint for the CargoBox.
- 12** In the Hypergraph, select only CargoBox.

6 | Animation

Lesson 5 > Applying parent constraints on an IK system

13 In the ChannelBox, view the parent constraints for CargoBox.

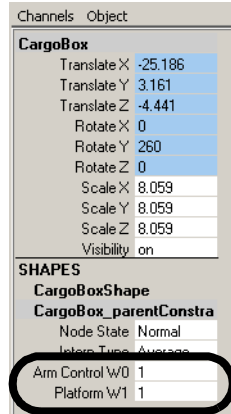

CargoBox has two parent constraints applied to it: Arm Control and Platform. In the ChannelBox, the numerical settings beside ArmControl W0 and Platform W1 represent the influence weight each parent constraint has on CargoBox. At this point, each influence weight is set to a value of 1. If you move the mechanical arm, the cargo box will move somewhere between its first and second position. This occurs because each constraint has equal influence on the cargo box at this point.

Before you can animate the objects in the scene, you also need to reset the default weight values for each constraint, so that one parent constraint has full influence on CargoBox when the other does not.

To set the weighting for the parent constraints

- 1** In the Hypergraph, select only CargoBox.
- 2** In the ChannelBox, set the following:
 - Platform W1: 0
- 3** Select only SwivelBase.
- 4** In the ChannelBox, set the Rotate Y value to 0.
The mechanical arm and cargo box are rotated back.
- 5** In the Hypergraph, select only CargoBox.

- 6** In the main menu, select **Constrain > Set Rest Position**.

Setting a rest position for CargoBox sets a position for the cargo box when no constraints are acting upon it. If the rest position is not set, CargoBox will be repositioned to the second constraint position.

- 7** In the ChannelBox, set the following:

- ArmControl W0: 0

At this point, both parent constraints are set to have no influence on the cargo box because their weight attributes are set to zero. When you animate the components in the scene, the weight attributes for the parent constraints will be set and keyframed depending on which constraining object (Arm or Platform) is required to have full influence.

In the next steps, you plan the action for animation of the IK system.

Planning an animation for an IK system

Now that the mechanical arm and cargo box are fully set up for animation it's a simple matter to pose the arm and set keyframes. Prior to setting any keyframes you should take a few moments to plan the action for the scene.

Planning the action usually involves sketching a simple storyboard, and writing out a brief timeline for the action for each component. In this lesson we've provided a simple version for you. The basic premise for the action is as follows:

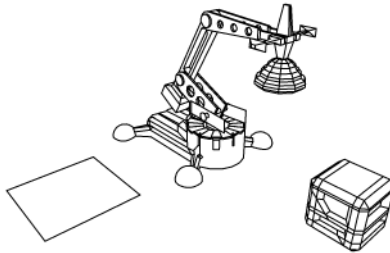

- The cargo box is positioned directly in front of the mechanical arm.

6 | Animation

Lesson 5 > Planning an animation for an IK system

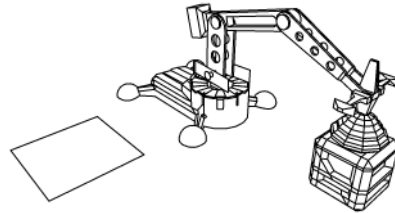

- The mechanical arm extends, and positions the cargo magnet to be directly touching the top of the cargo box.

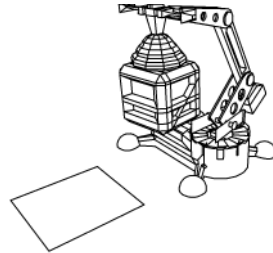

- The mechanical arm extends upwards, lifting the cargo box, and rotates to the side.

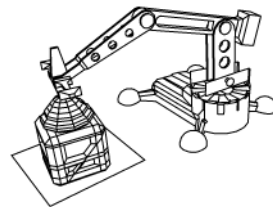

- The mechanical arm lowers the box, placing it in a new position.

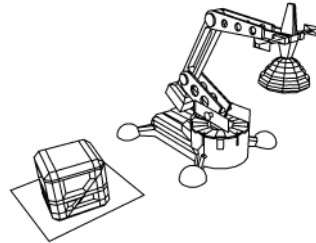

- The mechanical arm extends upwards, leaves the cargo box in the new location, and rotates back to its original position.

The table below breaks down the action indicating what action occurs for each object at the specified keyframes.

Frame	Mechanical Arm	Cargo Box
1	Collapsed position	Initial position
30	Vertically extended position	Initial position
60	Vertically lowered so that cargo magnet is positioned on top of cargo box	Initial position
80	Vertically lifted to extended position with cargo box	Cargo box lifted with mechanical arm
100	SwivelBase rotated along with arm to side	Cargo box repositioned along with mechanical arm
120	Vertically lowered along with cargo box to second position above surface	Cargo box is lowered along with mechanical arm to second position

6 | Animation

Lesson 5 > Animating an IK system

Frame	Mechanical Arm	Cargo Box
140	Vertically lifted to extended position	Second position
160	SwivelBase rotated with arm to original position	Second position
180	Collapsed position	Second position

To pose the mechanical arm you select either the ArmControl or SwivelBase nodes and set a keyframe depending on which component you want to pose:

- ArmControl controls the movement of the mechanical arm.
- SwivelBase controls the rotation of the arm.
- CargoBox's position is based on the parent constraint weights.

Animating an IK system

The animation sequence occurs over a 180 frame period. Before you begin to set keyframes you set the playback range in the Animation Timeline/Slider.

To set the playback range in the Time Slider

- 1 In the Animation Time and Range Slider, set the following start and end times for the animation:
 - Playback Start Time: 1
 - Playback End Time: 180



To simplify the keyframe workflow, you first set keyframes for the mechanical arm, and then set keyframes for the weight attributes of each parent constraint for the cargo box.

To set keyframes for the mechanical arm

- 1** In the Timeline, set the Time Slider to frame 1.
- 2** Select only ArmControl.
- 3** In the Channel Box, set the following values:
 - Translate Y: 0
 - Translate Z: -13
- 4** From the main menu, select Animate > Set Key.

To set the remaining keyframes for the arm and the swivel base, use the table below as a guide, and set the attributes in the following order:

- Set the frame using the Time Slider.
- Set the attributes for the object in the ChannelBox.
- Set the keyframe (Animate > Set Key).

Note Don't be concerned if the list of keyframes indicates to set a key twice for the same position over two frames. This is necessary to animate the parent constraint weights over a period of one frame.

Frame	Select	Set attribute	Select
1	ArmControl	TransY: 0 TransZ: -13	Set Key
30	ArmControl	TransY: 7 TransZ: -13	Set Key
59	ArmControl	TransY: -9 TransZ: 0	Set Key

6 | Animation

Lesson 5 > Animating an IK system

Frame	Select	Set attribute	Select
60	ArmControl	TransY: -9 TransZ: 0	Set Key
80	ArmControl	TransY: 6 TransZ: -13	Set Key
80	SwivelBase	RotateY: 0	Set Key
100	SwivelBase	RotateY: -100	Set Key
100	ArmControl	TransY: 6 TransZ: -13	Set Key
120	ArmControl	TransY: -9 TransZ: 0	Set Key
121	ArmControl	TransY: -9 TransZ: 0	Set Key
140	ArmControl	TransY: 6 TransZ: -13	Set Key
140	SwivelBase	RotateY: -100	Set Key
160	SwivelBase	RotateY: 0	Set Key
160	ArmControl	TransY: 6 TransZ: -13	Set Key
180	ArmControl	TransY: 0 TransZ: -13	Set Key

Once the keyframes for the mechanical arm are set you can use the playback controls to playback the motion for the mechanical arm.

To playback the animation using the playback controls

- 1 Click play on the TimeSlider playback controls to play the animation.
The mechanical arm animates over 180 frames. The cargo box does not move because the weight attributes for the parent constraints are set to zero and have not yet been set for the animation.
- 2 Click stop on the TimeSlider playback controls to stop the playback.

In the next steps, you set keyframes for the parent constraint weight attributes so the cargo box is lifted, moved, and placed in the second location. You set keys for the weight attributes on the parent constraint node.

To set keyframes for the parent constraint weights

- 1 In the Timeline, set the Time Slider to frame 1.
- 2 In the Hypergraph, select the node for the parent constraint directly below CargoBox.



- 3 In the Channel Box, set the following values (if they are not set already):
 - ArmControl W0: 0
 - Platform W1: 0
- 4 In the Channel Box, select the ArmControl and Platform channels by shift-clicking on the names.

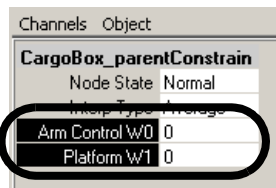

6 | Animation

Lesson 5 > Animating an IK system

- 5 Right-click on either one of the selected names.
A drop-down list appears.
- 6 From the drop-down list, choose Key Selected.
Key Selected sets a keyframe for the selected attributes only.

To set the remaining keyframes for the parent constraint weights, use the table below as a guide, keeping in mind that you set the attributes in the following order:

- Set the frame using the TimeSlider.
- Set the parent constraint attributes in the ChannelBox.
- Right-click on the selected names and select Key Selected.

Frame	Select	Set attribute	Select
1	CargoBox parentConstraint	ArmControl W0: 0 Platform W1: 0	key selected
59	CargoBox parentConstraint	ArmControl W0: 0 Platform W1: 0	key selected
60	CargoBox parentConstraint	ArmControl W0: 1 Platform W1: 0	key selected
120	CargoBox parentConstraint	ArmControl W0: 1 Platform W1: 0	key selected
121	CargoBox parentConstraint	ArmControl W0: 0 Platform W1: 1	key selected

To playback the animation using the playback controls

- 1 Click play on the TimeSlider playback controls to play back the animation.

The mechanical arm moves through the motion of the animation and picks up and moves the cargo box to the new location.

- 2 Click stop on the TimeSlider playback controls to stop the playback.
You have completed this lesson.

Beyond the lesson

In this lesson, you completed the animation of a mechanical arm model that picked up and moved a cargo box. You learned how to:

- Construct a model hierarchy to provide relationships between the components for posing and keyframing.
- Construct a single chain skeleton to pose the arm model using Inverse Kinematics.

It is common to create characters with multiple joint chains. For example, two and four-legged characters would use multiple joint chain skeletons to assist with posing their hierarchical structure. See *skeleton hierarchy* in the Maya Help. For a tutorial on creating a multiple chain skeleton see "Skeletons and kinematics" on page 296.

- Parent the components of the mechanical arm model into the skeleton hierarchy.

Parenting is one method for combining a model into a skeleton hierarchy. When using characters that have bending or deforming features a more common technique is to use Skin > Bind Skin. For more information see *Skeletons and skinning* in the Maya Help. For a tutorial on smooth skinning see "Smooth skinning" on page 311.

An easy method to parent one node to another using the Hypergraph is to drag one node over top of the other using your middle mouse button.

- Create an IK system with a control object for manipulation.

It is very common to create characters with multiple joint chains and multiple IK handles to control them. Control objects simplify the selection and posing of the character.

- Use three types of constraints (Point, Orient, Parent) to control components of the IK system and other components in the scene.

6 | Animation

Lesson 5 > Beyond the lesson

Constraints are useful for animating the attributes of one object based on the attributes of another. Other types of constraints not covered in this lesson include aim and scale constraints. See *Aim constraints* and *Scale constraints* in the Maya Help.

Using the parent constraint, the platform could also be animated to move the cargo box as if it were on an elevator, or a conveyor belt.

- Apply limits to the movement of the IK system.

In this lesson, you constrained the translation of the control object in order to constrain the movement of the IK. It is not recommended that you set limits on the rotation of an IK system as it limits how the solver calculates the position of the joints. See *Setting up joints for posing and animation* in the Maya Help.

Although not covered in this lesson, it is possible to simplify the display of attributes in the ChannelBox so that only the animatable attributes associated with a character are displayed.

- Pose and set keyframes for an IK system.

If you would like a more in-depth reference related to inverse kinematics and character setup, you may want to obtain *Learning Maya: Character Rigging* available from the Alias online store.

7 Character Setup

A typical 3D character can be made up of many surfaces and components. To ensure that the character animates in the way that you want, it is important to carefully plan the process of *character setup*.

Character setup or *rigging* is the general term used for the preparation of 3D models with their accompanying joints and skeletons for animation.

Depending on the model to be animated, character setup can involve the following techniques:

- Creating a skeleton with joints that acts as a framework for the 3D character model. You set limits on the joints so they rotate in a convincing manner. When you animate the character, you will be posing the character via its joints using either forward or inverse kinematic techniques (FK or IK).
- Binding the 3D surfaces to the skeleton so that they move together. The process of binding may also include defining how the character's joints bend or how the skin surfaces bulge to simulate muscles.
- Defining and setting constraints for particular animated attributes in order to restrict the range of motion or to control an attribute based on the movement of another.
- Grouping surface components such as CVs into sets called *clusters* so that parts of the character can be animated at a more detailed level.

This chapter introduces you to the most common character setup features:

- “Lesson 1 Skeletons and kinematics” on page 296
- “Lesson 2 Smooth skinning” on page 311
- “Lesson 3 Cluster and blend shape deformers” on page 322

Preparing for the lessons

To ensure the lessons work as described, select the Animation menu set. Unless otherwise noted, the procedures in this chapter assume the Animation menu set is selected.

7 | Character Setup

Lesson 1 > Open the scene for the lesson

Lesson 1 Skeletons and kinematics

After you model the surfaces that make up a human, animal, or other character, you create a skeleton and bind it to the character's surface (called *skin*).

A skeleton provides a structure for animating the character. When you create a skeleton in Maya, you create a series of bones with joints in the skeletal locations where you want the character to bend or twist. (You can animate a skeleton without having a skinned character.)

In this lesson, you learn the techniques for creating a simple skeleton for a human character. You will learn how to:

- Create joints for a character.
- Name joints in the Hypergraph.
- Use symmetry when creating a character.
- Parent joints into an existing skeleton.
- Use Inverse Kinematics (IK) techniques to pose a skeleton.

Learning how to bind a character to a skeleton is described in the next lesson.

Open the scene for the lesson

In this lesson, you'll work with a scene that we created for your use. The scene contains a human character. In the remainder of the lesson, you'll create and animate a skeleton for the character.

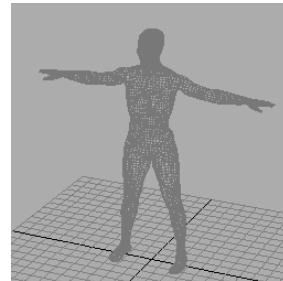

To open the scene

- 1** Make sure you've done the steps in "Preparing for the lessons" on page 295.
- 2** Open the scene named `Skeletons.mb`.

You can open the scene named `Skeletons.mb` from the *Maya Documentation, Lessons, and Extras CD* or from the drive where you copied the Getting Started with Maya data files.

The character displayed in the scene, Jackie, is a template, so you cannot unintentionally select it during the lesson. Jackie was modeled in the Da Vinci pose, the position that's easiest for creating a skeleton.

Creating joints

A skeleton is made of bones and joints. When you create a skeleton in Maya, you create a series of joints in the skeletal locations where you want the character to bend or twist.

A common technique for creating a skeleton is to create several independent joint chains—one for each arm, one for each leg, one for the spine/head—then group the chains together to create a single skeletal hierarchy. In the steps that follow, you create the joints for the legs.

To create joints for the legs

- 1** Select Window > Settings/Preferences > Preferences. In the Preferences window, click the Kinematics Category. Enter 0.4 for the Joint Size, then click the Save button.

This displays the joints smaller when you create them in the next steps. At the default size, 1.0, the size of the joints makes them hard to position accurately for this character.
- 2** Select Skeleton > Joint Tool. This is the tool for creating the joint chains that make up a skeleton.

7 | Character Setup

Lesson 1 > Creating joints

- 3 In a side view, click at the hip, knee, ankle, ball of foot, and toe to create joints at these positions (see the following figure). Make sure the knee joint is in a position that creates a slight forward bend. The forward bend ensures that you will be able to animate the leg easily in a direction natural for a leg.
- 4 Press Enter (Windows and Linux) or Return (Mac OS X) after creating the toe joint. This completes the joint chain.
- 5 Select Window > Hypergraph.

The Hypergraph is a convenient place to select, rename, and parent objects. It is similar to the Outliner, but it has features tailored for character setup. For example, it depicts all parent-child relationships in an easy-to-read indented format.

The Hypergraph shows the default names given to the joints just created: joint1, joint2, and so on. The joints have a hierarchical relationship. Joint1 is the parent of joint2, which is the parent of joint3, and so on. Joint1 is the root of the hierarchy. If you reposition joint1, you reposition the whole *joint chain*.

In the scene view, joints are represented by spherical icons. *Bones* separate the joints, and are represented by elongated pyramid icons. The narrow part of a bone points in the downward direction of the hierarchy.

The reason you create the hip joint first and the toe joint last is to have the hip at the top of the hierarchy and the toe at the bottom. You'll usually want the toe (and other joints) to move whenever you move the hip, but not necessarily vice versa. In general, joint chains emanate from the interior of the character outward.

- 6 Rename the joints as left_hip, left_knee, left_ankle, left_ball, and left_toe. To rename a joint, Ctrl right-click (Windows and Linux) the joint name in the Hypergraph and select Rename from the drop down menu. Type the new name and press Enter.

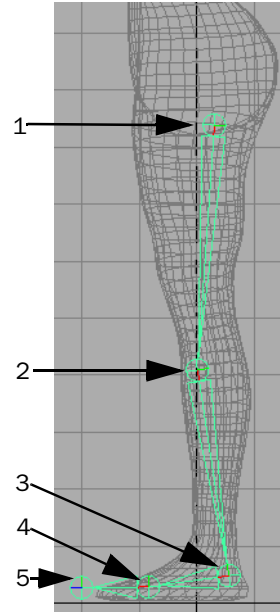

7 | Character Setup

Lesson 1 > Creating joints

- 7 In the front view, click the left_hip joint to select it. Move it along the X-axis to the center of the top of the left leg. (In this lesson, *left* and *right* refer to directions from Jackie's point of view, not from your view of the scene.)

As mentioned before, when you move a joint, all joints lower in the hierarchy move with it. If you press Insert (Windows and Linux) or Home (Mac OS X) while a joint is selected, you can move the joint without moving joints below it in the hierarchy. (To exit this mode, press Insert or Home again.)

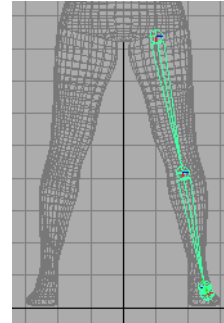

- 8 Rotate left_hip so that the skeleton fits inside the leg. It's unnecessary to fit the skeleton perfectly inside the character, as it won't be displayed when you render an image from the scene.
- 9 To create the joints for the other leg, you can save time and ensure symmetry by duplicating the existing leg joint chain with mirroring. With left_hip selected, select Skeleton > Mirror Joint > . In the options window, turn on YZ for Mirror Across.

Jackie's legs straddle the YZ plane, so mirroring the joint chain across the YZ plane positions the duplicate joint chain in the desired location. This operation illustrates that Jackie's original position affects the ease with which you can create the skeleton. Had Jackie been positioned away from the origin, you would not have been able to use Mirror Joint conveniently to duplicate the leg's joint chain.

- 10 Enter *left* in the Search For field and enter *right* in the Replace With field.

The Replacement Names for Duplicate joints feature automatically replaces the names of all duplicate joints with the specified joint prefix.

- 11 Click the Mirror button.

The right leg bones and joints appear in a mirrored position.

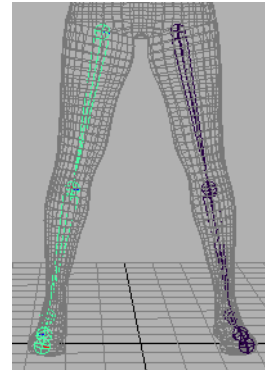

7 | Character Setup

Lesson 1 > Creating joints

In the next steps, you create a joint chain for the spinal column. You also extend a joint from the upper neck region of the joint chain so that you can animate the jaw.

To create joints for the spine and jaw

- 1** In the side view, use the Joint Tool to create a series of joints at the locations shown in the figure. Start at the base of the spine near the existing hip joints (left_hip and right_hip) and end at the top of the head. Make sure you create the first joint a little bit away from the existing hip joint displayed in the front view. Otherwise the first joint will be connected to the hip joint. Remember to press Enter (Windows and Linux) or Return (Mac OS X) when you are done creating the joint chain.

With the exception of the joints at each end of the joint chain, the joints are located where the character is likely to bend or twist at the spine and neck.

The S-shaped curvature of the joint chain resembles Jackie's spinal curvature. This makes it easier to animate the character's torso and neck naturally.

- 2** Starting at the base of the spine, name the joints back_root, pelvis, lower_back, mid_back, upper_back, lower_neck, upper_neck, and crown.
- 3** To set up the skeleton for jaw movement, extend a joint from the upper_neck joint. With the Joint Tool selected, click the upper_neck joint in the Hypergraph to select it, then click to create a new joint near the lips, and press Enter or Return. Name the new joint as jaw.

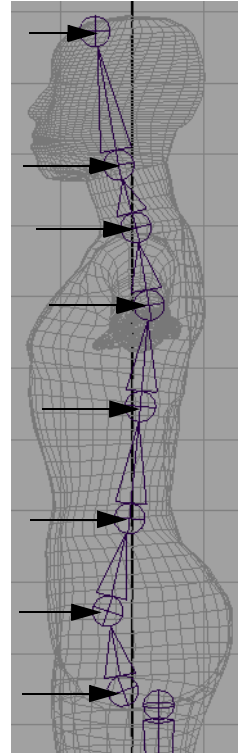

7 | Character Setup

Lesson 1 > Creating joints

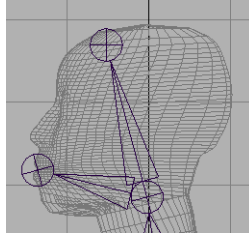

Creating joints for the arms is similar to creating joints for the legs.

To create joints for the arms

- 1** In the front view, create a series of joints at the locations shown in the figure. Start at the pectoral region (near the upper_back joint) and end at the wrist.

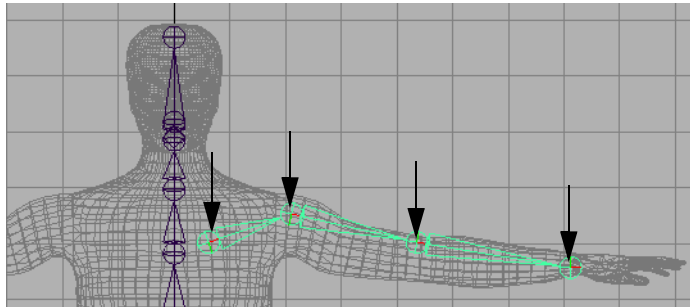

- 2** Name the joints left_arm_root, left_shoulder, left_elbow, and left_wrist.
- 3** In the top view, select the left_elbow joint, select the Move tool, press Insert (Windows and Linux) or Home (Mac OS X), then move the joint to the back of the arm. Press Insert or Home again.

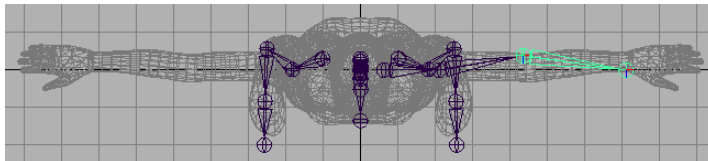

7 | Character Setup

Lesson 1 > Adding joints to a skeleton

Moving the joint to the back of the arm creates a bend at the elbow. This will make it easier to animate the character's arm in the direction an arm naturally bends.

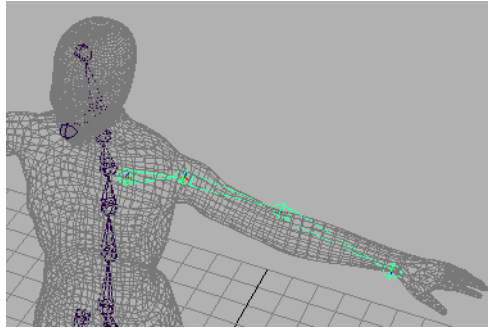

- 4 In the perspective view, select `left_arm_root`. Select `Skeleton > Mirror Joint`. This creates a copy of the left arm's joint chain for the right arm and renames them in the process.

The right arm bones and joints appear in a mirrored position.

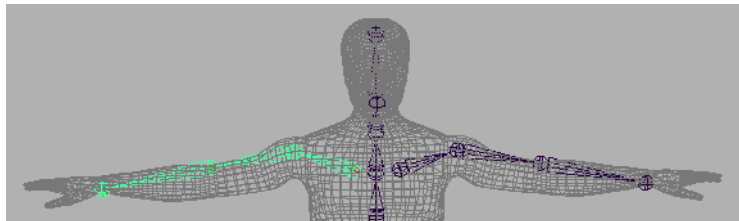

Adding joints to a skeleton

When you bind a character to a skeleton (described in the next lesson), the skeleton provides a structure for the character's skin and prevents the skin from collapsing as you pose the skeleton.

It's useful to add extra joints in areas of the character where you want the surface to keep its volume upon deformation. In the next steps, you'll add ribs to Jackie's skeleton. Although you will not bind the character in this lesson, the

7 | Character Setup

Lesson 1 > Adding joints to a skeleton

technique of adding ribs is important to learn so that when you do bind a character, the skin in the torso area will not collapse as you pose shoulder and spinal rotations. The rib joints are for structure only, not for posing the skeleton.

To add ribs to the skeleton

- 1** In the Hypergraph, click the mid_back joint to highlight the joint in the front view. Remember the location of the joint in the front view so you can select it later (step 3).
- 2** Select Skeleton > Joint Tool.
- 3** In the front view, click on the mid_back joint to select it again.
- 4** Click to the side of the joint to add a rib bone, then press Enter (Windows and Linux) or Return (Mac OS X).

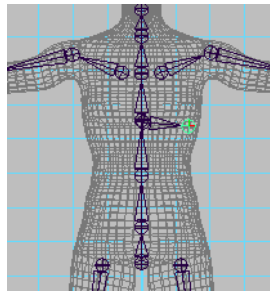

- 5** With the same technique as in the prior steps, create two more ribs for the left side. The ribs extend from the mid_back, lower_back, and pelvis joints.

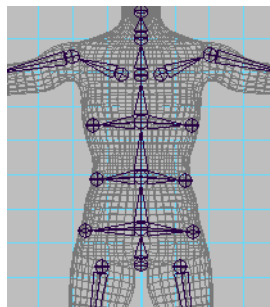

7 | Character Setup

Lesson 1 > Creating a skeleton hierarchy

- 6 For easy identification in the Hypergraph, you can optionally name the ribs as desired. For instance, name them `left_top_rib`, `left_mid_rib`, `left_bottom_rib`, and so on.
- 7 Mirror the left rib joints to create ribs for the right side of the skeleton.

Creating a skeleton hierarchy

So far you have created five separate joint chains: one for the spine, and one for each arm and each leg. You need to create a single hierarchy from the five joint chains so you can move all of them as a single unit. To create the single hierarchy, you parent the arms and legs to the nearest joint in the spine.

To parent the arm and leg joint chains to the spine

- 1 In the Hypergraph, use the middle mouse button to drag `left_arm_root` to `upper_back`.
When you parent one joint to another, Maya creates a bone that connects the parent to the child. In this case, the bone connects `upper_back` to `left_arm_root`.
- 2 Use the middle mouse button to drag `right_arm_root` to `upper_back`.
- 3 Use the middle mouse button to drag `left_hip` to `back_root`.

- 4 Use the middle mouse button to drag `right_hip` to `back_root`.

Now if you need to move the entire skeleton, you can move `back_root`—the root of the hierarchy. The completed skeleton is shown in the following figure (with Jackie hidden):

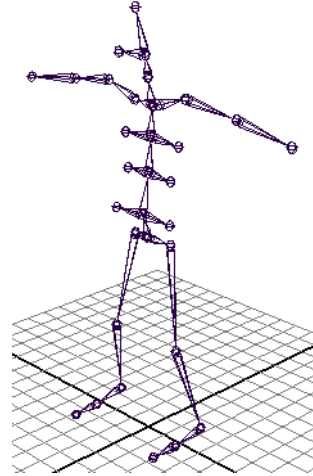

Forward and inverse kinematics

There are two techniques for posing a skeleton: forward kinematics and inverse kinematics.

Forward kinematics (FK)

To pose a character with forward kinematics, you rotate each joint individually until you get the desired positioning. For example, to move a hand to some location, you must rotate several arm joints to reach the location.

When you animate a skeleton posed with forward kinematics, Maya interpolates the joint rotations starting with the root joint, then the root's child joints, and so on down through the skeleton's action hierarchy. Maya proceeds forward through the action hierarchy, starting at the root joint.

Forward kinematics is intuitive for creating simple arc motions, but it's tedious if you are animating a complex skeleton. It's also not intuitive for specifying goal-directed motion. For example, to move a hand to some location, it's not obvious how to rotate the joints in an arm.

Inverse kinematics (IK)

With IK, you create an extra control structure, an *IK handle*, for certain joint chains such as arms and legs. An IK handle lets you pose and animate an entire joint chain by moving a single manipulator.

As you pose the IK handle, it automatically rotates all the joints in the joint chain. For example, if you move a hand to a doorknob, the other joints in the arm rotate to accommodate the hand's new positioning.

7 | Character Setup

Lesson 1 > Posing and animating using inverse kinematics

IK is more intuitive than forward kinematics for goal-directed motion because you can focus on the goal rather than on how you need to rotate each joint to achieve that goal.

Posing and animating using inverse kinematics

Next, you create IK handles that you'll later use to pose the arms and legs. The next steps describe some initial setup you should perform before creating the IK handles.

To set up the character prior to creating IK handles

- 1** Select the root of the hierarchy, `back_root`, and then select `Skeleton > Set Preferred Angle`.

This sets the current joint angles throughout the skeleton as the preferred angles. This is a useful step after you complete a skeleton. Maya thereafter uses the current bend in the knees and elbows as the preferred initial rotation direction of these joints during inverse kinematics (IK) posing. This makes it easier to pose the character with motion that is natural for a human character.
- 2** Select Jackie in the Outliner and select `Display > Hide > Hide Selection`. (You must select and hide Jackie from the Outliner because Jackie is a template object.) By hiding Jackie, you'll lessen scene clutter as you pose the skeleton in the following steps.

To create, pose, and animate IK handles for the legs

- 1** Select `Skeleton > IK Handle Tool > □`.
- 2** In the Tool Settings window, make sure Current Solver is set to `ikRPsolver`.
This type of IK solver has characteristics that work well for this application.
- 3** In the perspective view, click `left_hip` and `left_ankle`.

This creates an IK handle that lets you control all joints from `left_hip` through `left_ankle`. The handle's main manipulator is at the `left_ankle`.

The IK handle is the selected object after you create it. If you unintentionally cancel the selection of the handle, you can select it again by clicking the `left_ankle`—the last joint you clicked after using the IK Handle Tool.

7 | Character Setup

Lesson 1 > Posing and animating using inverse kinematics

Whenever you select a handle, make sure you do not select joints or other objects along with the handle. You can check the Outliner to confirm your selection.

- 4** Go to the start of the playback range.
- 5** With the IK handle selected, select **Animate > Set Key** to key the leg's current position at the first frame.
- 6** Go to frame 12.
- 7** In the side view, use the Move tool to drag the IK handle up and to the left (see illustration), as if Jackie were stepping up a staircase. The foot and knee move while the hip stays in place.
- 8** Set another key for the IK handle.
- 9** Go to frame 24. Move the IK handle back to its prior position. Set another key.
- 10** Play the animation to see the leg step up and down during the first 24 frames.

This completes a simple animation of the leg using an IK handle to control its position.

To practice additional IK techniques

- 1** Go the start of the animation.
- 2** In a perspective view, practice posing the leg in various directions by moving the IK handle.

No matter how far you drag the handle manipulator, the joints of the leg will not stretch beyond the straight leg position. This is desirable; you do not want the size of a skeleton to change as you pose it. However, if you drag a leg joint, the bone hierarchically above that joint will lengthen. This is why it's important to check that you haven't selected a joint with the IK handle before you move the handle.

As you drag the handle to some positions, you might notice the leg joints flip abruptly (see the next figure for an example position). It's therefore hard to control the leg positioning in this region.

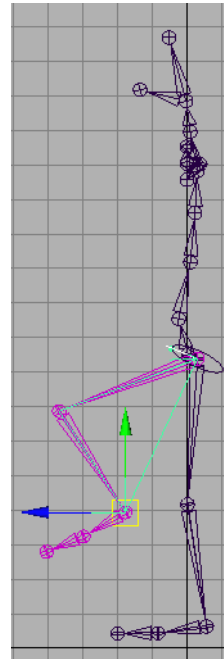

7 | Character Setup

Lesson 1 > Posing and animating using inverse kinematics

The default IK handle (*IK Rotate Plane handle*) has manipulators you can use to avoid joint flipping. With the handle selected, select **Modify > Transformation Tools > Show Manipulator Tool**. Move the Pole Vector XYZ manipulator to a slightly different position (see the following figure).

If this doesn't solve the problem, rotate the Twist manipulator to rotate the leg. You can key the Pole Vector XYZ and Twist attributes to fixed values to avoid the flipping as the character moves.

A more precise way to avoid joint flipping, which requires some initial setup, is to use a Pole Vector Constraint. For more information see the Maya Help.

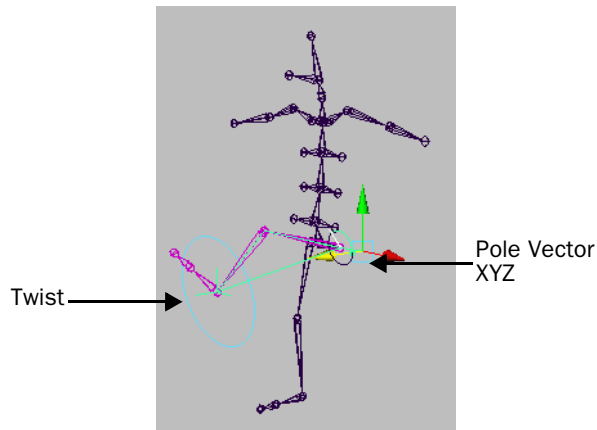

- 3 Repeat the preceding steps for the right leg. (Create an IK handle for the right_hip to right_ankle, then practice posing and animating the handle.)

Note If you want to move the entire skeleton, group the back_root and all IK handles under a single node, select the group node, and then use the Move tool. With this grouping, the motion of the entire skeleton won't conflict with the keys you set for the handles.

To create, pose, and animate IK handles for the arms

- 1 Select **Skeleton > IK Handle Tool**.

- 2 Click left_shoulder, and then click left_wrist. This creates an IK handle for the left arm.
- 3 Select Skeleton > IK Handle Tool.
- 4 Click right_shoulder, then click right_wrist. This creates an IK handle for the right arm.
- 5 Practice posing and animating the handles.

Posing and animating using forward kinematics

As the last part of the lesson, you can optionally practice posing and animating the character by rotating joints that are not controlled by IK handles—the ball joints of the feet, and joints from the back_root through the upper_neck. Rotating such joints is forward kinematics.

With the exception of the back_root, you'll invariably rotate rather than move the joints that aren't part of an IK handle. If you move the joints, the bones lengthen. This deforms bound skin undesirably unless you are creating cartoon-like distortions.

Because you've already set keys for IK handles, some joint rotations on non-IK handle joints will be restrained by the IK handle positioning. If this interferes with the intended poses, you can remove all prior animation from an IK handle by selecting Edit > Keys > Delete Keys. You can also use Delete Keys to remove all animation from keys you've set with forward kinematics.

Beyond the lesson

In this lesson you learned how to:

- Create a skeleton with bones and joints.
- Pose the skeleton using Inverse Kinematics.

Additional things to consider when working with skeletons:

- The appropriate number of joints in a skeleton depends on the anatomical parts of the character you want to manipulate. More joints means finer control at the expense of greater complexity.

7 | Character Setup

Lesson 1 > Beyond the lesson

- As you created the skeleton in this lesson, you ended the arm's joint chain at the wrist. This prevents you from animating hand motion. If you need to animate hand motion or even finger motion, you would need to make additional joints and IK handles. The same applies to foot and toe motion.
- When you create a skeleton, you can animate a character bound to it to produce natural skin deformations. Although you animated an unskinned skeleton in this lesson, it's more common to animate a skinned skeleton. Binding a character is the topic of the next lesson.
- It's typically best to animate the entire skeleton from pose to pose at desired frames. It's hard to get desired results by animating one limb for a frame range, another limb for a frame range, and so on.

There are many other ways to work with skeletons not described in this lesson:

- You can blend or switch between IK and forward kinematics on joints controlled by an IK handle.
- There are other types of IK handles that provide different controls for manipulating parts of a skeleton. Especially noteworthy is the IK spline handle, which makes it easy to animate the twisting, wavy motion in tails, necks, spines, snakes, and so on.

For more details on these and other features, please refer to the Maya Help.

Lesson 2 Smooth skinning

After you create a skeleton, you *bind* it with the character's surface so that the surfaces move with the skeleton during animation. Binding is also called skinning, and a character's surface after binding is called a *skin*.

It is important that the character's skin deforms naturally as the skeleton moves. Near joints, the skin bulges or indents when you rotate the joints.

In Maya, the skin deforms because the surface's vertices (or CVs) move in response to the rotation of adjacent joints. The vertices are known as skin points. This is useful for animating elbows, shoulders, necks, and so on.

By default, the influence a joint has on a skin point's movement depends on how close it is to that joint. You can edit skin point weighting to change the default movement.

In this lesson you learn how to:

- Bind a skeleton using a smooth bind technique.
- View and modify skin weights using the Skin Weights Tool.
- Use influence objects to enhance the skin deformation of a character.

Open the scene for the lesson

In this lesson, you work with a scene we created for your use. The scene contains a human character and skeleton. Each leg and arm of the skeleton has an IK handle that lets you pose the limbs conveniently. If you completed the prior lesson, the character, skeleton, and IK handles will be familiar.

- 1** Make sure you've done the steps in "Preparing for the lessons" on page 295.

You can open the scene named `SmoothSkin.mb` from the *Maya Documentation, Lessons, and Extras* CD or from the drive where you copied the Getting Started with Maya data files.

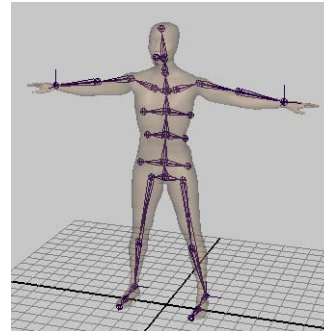

7 | Character Setup

Lesson 2 > Smooth binding a skeleton

The character in the scene, Jackie, is displayed with transparency so you can see the skeleton beneath the surface.

- 2 Select Window > Settings/Preferences > Preferences. In the Preferences window, click the Kinematics Category. Enter 0.4 for the Joint Size, then click the Save button.

This displays the joints smaller. At the default size, 1.0, the large size of the joints obstructs the view of the skin.

Smooth binding a skeleton

You use Jackie as the surface to be bound to the skeleton.

To bind the skeleton using smooth skinning

- 1 Select Jackie.
- 2 Shift-select the back_root joint.
The back_root joint is at the base of Jackie's spine. If you are not sure which joint it is, select it in the Hypergraph (Window > Hypergraph).
- 3 Select Skin > Bind Skin > Smooth Bind > .
The Smooth Bind Options window appears.
- 4 In the Smooth Bind Options window, set Max Influences to 3, then click Bind Skin.

A Max Influences value of 3 specifies that three joints influence each skin point. By default, the joint closest to the point has the most influence. The second most influential joint is that joint's parent or child joint, whichever is closest to the point. The third most influential joint is the nearest parent or child of the second joint. The influence drops with the distance from the joints. The amount of influence each joint has on any skin point is the *skin weight*.

The default skin weights create smooth deformations of the skin at elbows, knees, and elsewhere as the nearby joints rotate.

- 5 Select and move any or all of the four IK handles to pose the arms and legs in various positions in order to get used to posing with the IK handles.
To select an IK handle, drag a selection box around a wrist or ankle joint. To move a handle, use the Move tool to drag the handle in the desired direction.

Note that you can also select the IK handles in the Hypergraph. The handles are indented under `jackieSkeleton`. Each is named for a leg or arm, for example, `ikHandleLeftLeg`. For more details on IK handles, see “Lesson 1 Skeletons and kinematics” on page 296.

- 6 If you prefer to turn off the skin’s transparency so you can see the skin more clearly, turn off `Shading > Shade Options > X-Ray`. Do not be concerned that the skeleton pokes through the skin, as the skeleton is not displayed in a rendered image.

As you pose the arms and legs, examine the skin in the regions where joints bend. For many poses, the skin looks natural. For others, the skin folds, compresses, or bulges unnaturally. The pelvis, shoulders, and torso are common problem areas for various poses. For example, if you move an arm straight up, the shoulder compresses as in the following figure.



There are two ways to improve the smooth skin deformations:

- Add an influence object to eliminate collapsing regions or to create muscle bulge. For example, you can use an influence object to make the shoulder region look more natural in the prior pose.
- Edit skin weights—to remove minor lumps or indented regions. For example, you can fill out an undesirable concave region at the chest that appears when you move the arm to certain poses.

The following procedures explain the techniques.

7 | Character Setup

Lesson 2 > Skin weighting and deformations

Skin weighting and deformations

In the next steps, you'll learn how joints and skin weights influence deformations at Jackie's chest. In a subsequent section, you'll improve uneven deformations.

To see how skin weights affect a skin's deformation

- 1 Pose the left arm similar to the following figure. The left breast becomes irregularly shaped.

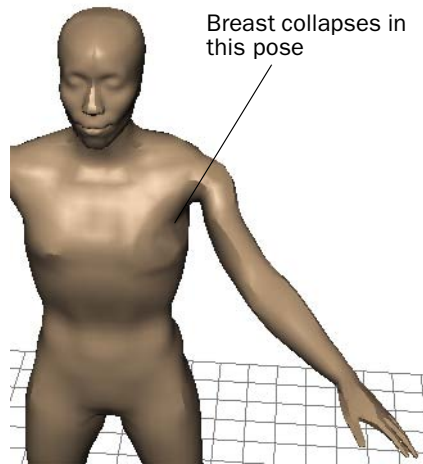

- 2 Select Jackie.
- 3 Select Skin > Edit Smooth Skin > Paint Skin Weights Tool > .
- 4 In the Influence list of the Tool Settings window, select any joint, for instance, pelvis. The grayscale color of Jackie's skin indicates how much influence that joint has on the skin's deformation.

White means the skin is maximally influenced by the joint. Black means the skin is not influenced by the joint. Gray means the influence is partial. The lighter the gray, the more the influence.

Each point on the surface is influenced by three joints, as specified by the Max Influence setting in a prior step. However, one or two of the three joints might have so little influence as to be insignificant.

In general, a white region of skin is influenced nearly entirely by the joint selected in the Influence section of the Tool Settings window. A gray region is influenced significantly by one or two additional joints.

- 5** The reason the left breast becomes irregularly shaped as you pose the arm is that some joint is exerting too much or too little influence on the breast.
- 6** Select each entry in the Influence list to determine which joints are influencing the irregular region of the breast. The region will be a shade of gray (or white) when you select the appropriate joints. The `left_arm_root` is the main influence. The `upper_back`, `mid_back`, and `left_top_rib` also have influence, though not exactly in the same region.

Modifying skin weights

You can modify the skin weights for any of the influencing joints to alter the irregular region. If you don't get the desired results when you change the skin weights of one of the influencing joints, you can undo your changes and try another influencing joint.

In general, it's best to modify the skin weights of the most influential joint first, then work with less influential joints if you don't get the desired results. Modifying skin weights requires experimentation.

In the next steps, you'll modify the skin weights for the `left_arm_root` joint.

To modify skin weights using the Paint Skin Weights Tool

- 1** Select `left_arm_root` in the Influence list.
- 2** In the Paint Weight Menu section of the window, set Value to 0.1 and turn on Add.
- 3** Drag the mouse pointer to paint the irregular region of the breast. Each stroke adds 0.1 (10%) to the skin weight. The weight for a skin point has a maximum value of 1 (fully white).

Tip Painting skin weights using a tablet with stylus allows you to take advantage of pressure sensitivity.

7 | Character Setup

Lesson 2 > Modifying skin weights

Repeat the strokes several times until the irregular region becomes smoother. The jagged, asymmetrical wireframe at the breast becomes more symmetrical as the skin becomes smoother. The region whitens, which indicates increased influence from the left_arm_root joint. Note that increasing the influence of one joint lessens the influence of the other influencing joints.

- 4 To check the shape with full-color shading, click the Select Tool. (You might also prefer to cancel the selection of Jackie to eliminate the display of the highlighted wireframe.)

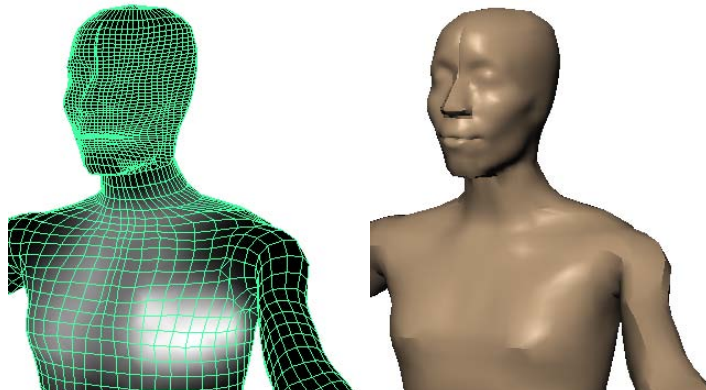

- 5 To continue modifying the skin weights with the Paint Skin Weights Tool, select Jackie and once again select Skin > Edit Smooth Skin > Paint Skin Weights Tool.

There are several additional tool settings you might find useful as you modify skin weights:

- The Smooth operation smooths the weights of points by averaging the stroked points with the weights of the surrounding region. This is useful if you add to the weight values in some region but the points become unevenly weighted. Uneven weights are indicated by mottled gray skin.
- You can use the Scale operation with a Value less than 1 to scale down the point weights of a stroked region.
- As you stroke a region, the red circle icon displays the radius of the region affected by the stroke. The Radius(U) value changes the radius.

- You can select any of the Profile icons to specify the region affected by strokes. The two leftmost icons are the most commonly used shapes.
- 6** After you eliminate the irregular region from the left breast, move the arm to different positions to see if the breast's shape stays natural in various poses. It is common for a surface to look good in one pose but not in another. Strive to make the surface look good in the poses that you are likely to use during animation.
- 7** If you want more practice, pose the right arm as you posed the left arm and fix the corresponding irregular region in the right breast. This time, fix the region by modifying the weights for the `upper_back` joint rather than the `right_arm_root`. As mentioned previously, you can modify point weights of alternative joints to get a similar effect.

Influence objects

You can create an object and use it to influence the shape of smooth skin. The object, called an influence object, acts like a surgical implant against which the skin deforms. For example, you can create a sphere and use it to simulate a muscle or bone that bulges as you pose the character in certain positions. You can also use an influence object to smooth deformation and maintain volume in regions that collapse while bending.

In the next steps, you'll use a sphere as an influence object to simulate an elbow jutting out as Jackie's arm bends. To use an influence object, the skeleton must be in the bind pose—the original pose at which the skin was bound to Jackie.

To return the skeleton to the bind pose

- 1** Click the Select Tool and cancel the selection of Jackie.
- 2** Turn off Modify > Evaluate Nodes > IK Solvers.
After you use an IK handle to pose a character, you must do this step before you can return the skeleton to the bind pose.
- 3** Select `back_root`, the root of the skeleton.

7 | Character Setup

Lesson 2 > Influence objects

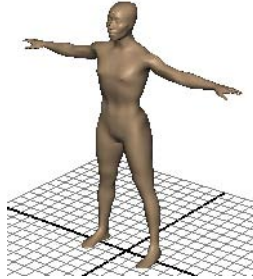

- 4** Select Skin > Go to Bind Pose.
- 5** Select the ikHandleLeftArm in the Hypergraph. Use the Move Tool to move the handle manipulator slightly in any direction. When you release the mouse, note that the arm does not move and that the IK handle manipulator snaps back to the desired position at the end of the joint chain. Repeat this step for any other IK handles you posed previously.
- 6** Turn on Modify > Evaluate Nodes > IK Solvers.
You must do this step to enable the IK solvers so you can manipulate IK handles in the scene again.

To position a sphere to be used as an influence object

- 1** Right-click Jackie's surface (anywhere but on the skeleton) and select Actions > Template from the marking menu.
By making Jackie a template, you won't accidentally select Jackie in subsequent steps.
- 2** Select Create > Polygon Primitives > Sphere, and name the sphere `elbow_influence`.
- 3** Scale the sphere to be slightly smaller than any of Jackie's joints (see illustration below).
- 4** Move the sphere so that its surface is positioned where the elbow would jut out, but still within the skin. You can optionally reshape the sphere's curvature to resemble the tip of an elbow jutting out from a bent arm. For example, you can scale the sphere in one dimension to squash its shape or you can move individual vertices. A top view of the sphere's shape and position follows:

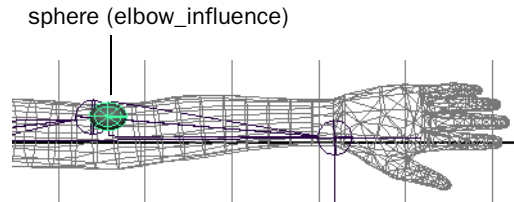

The exact position and scale of the sphere is unimportant. You can make slight position and scale adjustments later to enhance the deformations that result from its use.

To make the sphere an influence object

- 1** In the Hypergraph, select Jackie and Shift-select `elbow_influence`.
- 2** Select `Skin > Edit Smooth Skin > Add Influence >` . In the Add Influence Options, select `Edit > Reset Settings`, and then click the Add button.
Maya completes the operation within a few moments. To ensure the influence object stays in the correct position at the elbow, you will parent it to the `left_shoulder` joint.
- 3** In the Hypergraph, shift-select `elbow_influence`, `elbow_influenceBase`, and `left_shoulder` joint, in that order.
The order of selection is important. The parent object should be selected last.
- 4** Press `p` to parent the elbow nodes under the `left_shoulder` joint.
The `elbow_influence` nodes appear in the skeleton hierarchy below the `left_shoulder` joint.
The `elbow_influenceBase` is known as a base object. It stores vertex position information for the influence object. The reason for parenting the base object to the `left_shoulder` joint is so that the influence object's vertices stay in the correct position at the elbow whenever the elbow moves to a new position. Other than this step, you do not work with the base object.
- 5** Right-click Jackie and select `Actions > Untemplate`. It is easier to see subsequent skin deformations when Jackie is displayed with smooth shading rather than as a template.

7 | Character Setup

Lesson 2 > Beyond the lesson

- 6 From the menus at the top of the top view, turn off Show > Joints to avoid having the joints obstruct your view of the skin.
- 7 Use each arm's IK handle (ikHandle1 and ikHandle2) to pose the arms in the following position.

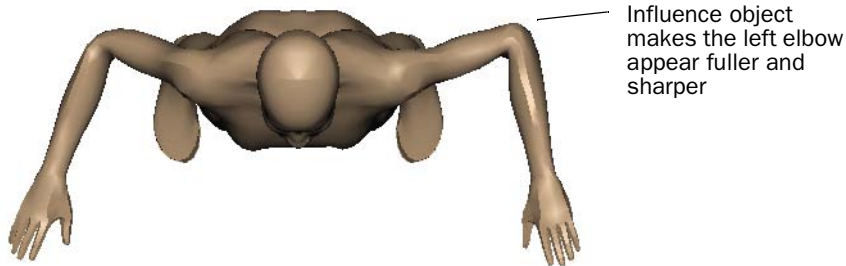

The left elbow looks more natural than the right elbow. To tune the elbow's deformation during bending, change the position, scale, and rotation of elbow_influence.

Do not be concerned if the influence object pokes through the skin. It won't be displayed when you render the animation.

Beyond the lesson

In this lesson you learned how to:

- Bind a skeleton to a single surface.
You can bind a skeleton to multiple surfaces or even to a selection of polygonal vertices or NURBS CVs or subdivision surfaces.
- Use the Paint Skin Weights Tool to prevent a region from collapsing upon deformation.
To control skin weights with more precision than shown in the lesson, you can modify skin weights numerically with the General Editors > Component Editor. If you smooth skin multiple surfaces which have been seamed together, there are many tool settings for the Paint Skin Weights Tool that make the task easier.
- Use an influence object to make an elbow stick out upon bending.

Another common use of an influence object is to simulate a muscle bulging during joint rotation. The technique requires use of Set Driven Key to link the bulging influence object's scale values to the rotation of the appropriate joint. A brief example of this technique is in the Maya Help for Smooth Skin.

Skin weights and influence objects cannot overcome all modeling problems. For instance, if you further separate Jackie's legs sideways, you will see an undesirable fold at the hips. This occurs because of the asymmetrical arrangement of polygonal edges in the hip region of the original model. To fix the problem, you would need to detach the skin, alter the original model, then smooth bind the model again.

Maya has an alternative skinning method, rigid skinning, which gives results similar to smooth skinning but requires use of different enhancement tools: flexor and lattice deformers. In general, smooth skinning gives more natural deformations with less effort than rigid skinning. If you skin multiple seamed surfaces, however, processing is faster with rigid skinning than with smooth skinning.

Smooth skinning is just one of the techniques for perfecting a character's deformations during animation. You can use Maya's other deformers alone or in addition to smooth skinning to achieve the results you want.

For more information, please refer to *Smooth skinning* in the Maya Help.

7 | Character Setup

Lesson 3 > Open the scene for the lesson

Lesson 3 Cluster and blend shape deformers

Facial animation is an integral component of character animation. The face of a character can be animated to impart a range of emotions and expressions. Maya has two deformation tools that ease character setup for facial animation: cluster deformers and blend shape.

Cluster deformers enable you to control a set of an object's points (CVs, vertices, or lattice points) with varying amounts of influence to create a target shape for an animation.

A Blend Shape deformer provides an interface for blending between various target shapes, to control the range of movement for the cluster on an object or face.

In this lesson, you will be introduced to cluster deformers in order to shape a character's mouth into a smile pose. You will learn to use the Blend Shape feature so you can animate the face from a neutral pose to a smile. In this lesson, you learn how to:

- Select CVs in a region and create a cluster deformer.
- Use the cluster deformer handle to adjust the position of a cluster deformer.
- Use the Paint Cluster Weights Tool to refine the cluster weight values.
- Create a Blend Shape deformer to control the blending between target shapes.

Open the scene for the lesson

In this lesson, you'll work with a scene we created for your use.

- 1** Make sure you've done the steps in "Preparing for the lessons" on page 295.
- 2** Open the scene named `ClusterBS.mb`.

You can open the scene named `ClusterBS.mb` from the *Maya Documentation, Lessons, and Extras CD* or from the drive where you copied the Getting Started with Maya data files.

The scene contains a man's head.



Model by Ken Yao

- 3 Select Shading > Smooth Shade All and then Shading > Hardware Texturing, and Lighting > Use All Lights to view the head fully textured (Hotkey 7).

Creating a target object for a blend shape

In the next steps, you duplicate the face of the head to create a target object for the blend shape. Later in the lesson, you apply a cluster to the duplicated face (target object) so you can create a smile. The facial expression on the target object is what the original base object will match.

- 1 Using the Outliner, select only the face. That is, select only the head surface without the eyes, ears, and hair.
In the Outliner, the face is named `baseFace` and is indented under `head`.
- 2 Select Edit > Duplicate > . In the options window, select Edit > Reset Settings, turn on World for the Group Under option, then click the Duplicate button. By grouping the duplicate under the world, you create an object independent of the original.
- 3 Move the duplicate face to a position where both faces are visible for comparison, for instance, to the right side of head.

7 | Character Setup

Lesson 3 > Creating a cluster deformer on a target object

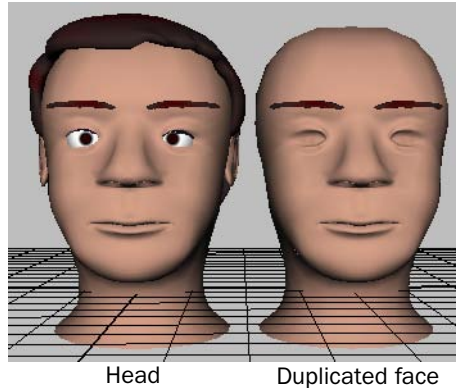

- 4 Rename the duplicate face as `smilingFace`.

This duplicate face will be modified so it can be used to influence the original.

Creating a cluster deformer on a target object

In the next steps, you create a cluster deformer on the duplicated face (target object) to reshape the expression into a smile. The cluster deformer on the target object will be used to change the unsmiling `baseFace` (base object) into a smiling face.

A cluster deformer creates a set whose members consist of selected points (CVs, vertices, or lattice points). You assign a percentage weight to each point, indicating how much you want each point to be affected by any translation, rotation, or scale of the cluster set. When you transform the cluster, the points are transformed according to the percentages you have specified. A cluster is useful for stretching, moving, or compressing part or all of a surface.

To create a cluster deformer

- 1 Position the mouse pointer over the face. Right-click to select `Vertex`, then select the `smilingFace` vertices shown in the following illustration, which are roughly the vertices at the chin, cheeks, and lips (but not the nose):

7 | Character Setup

Lesson 3 > Creating a cluster deformer on a target object

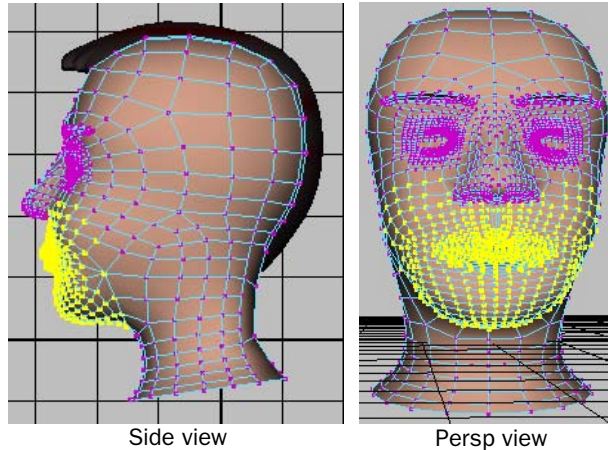

The region of selected vertices does not need to be exact. The objective is to select all vertices where a smile might deform the face. You might want to look in a mirror to see which parts of a face move while smiling. It's better to select too many vertices than too few. It's easier to work with too many vertices than too few.

An easy way to select the vertices is to use the Paint Selection Tool. First, right-click smilingFace in the scene view and select Vertex from the marking menu. Select Edit > Paint Selection Tool > . In the resulting options window, set Radius(U) to 0.2. Drag the mouse on the desired vertices. Ctrl-drag (Windows and Linux) or Control-drag (Mac OS X) to cancel the selection of inadvertently selected vertices. Close the Tool Settings window when you are done.

Make sure you don't select vertices at the back of the head inadvertently. Also make sure you don't inadvertently miss a few vertices in the region you select.

2 Select Deform > Create Cluster.

This puts the vertices into a cluster—a set of points you can move as single entity. The cluster's handle appears in the view as a C icon.

3 In the Outliner, make sure the cluster2Handle is selected.

4 Use the Move tool to drag the cluster handle up along its Y-axis a small amount until smilingFace is deformed as follows:

7 | Character Setup

Lesson 3 > Editing cluster weights

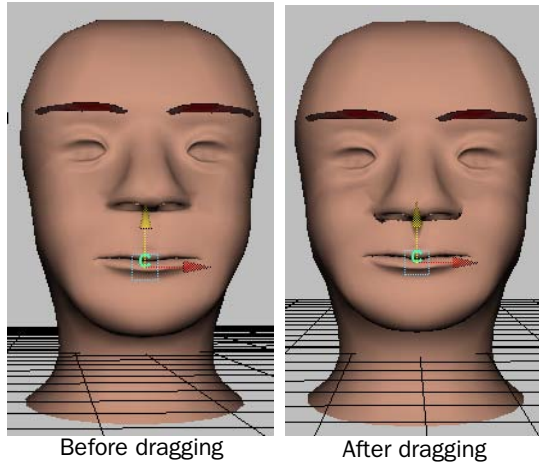

The cluster set on smilingFace should be slightly higher than the math on the original face. This will become the basis for the blend shape deformer.

Editing cluster weights

In this section you will use the Paint Cluster Weights Tool to further refine the smilingFace. As you saw in previous steps, the points in a cluster move when you move the cluster handle. The distance a particular point moves depends on its *weight*. Lower weights cause less movement, while higher weights cause exaggerated movement. In the next steps, you create a smile by editing the weights.

To edit cluster weights using the Paint Cluster Weights Tool

- 1 Select smilingFace.
- 2 Select Deform > Paint Cluster Weights Tool > . This displays the smilingFace in grayscale.

7 | Character Setup

Lesson 3 > Editing cluster weights

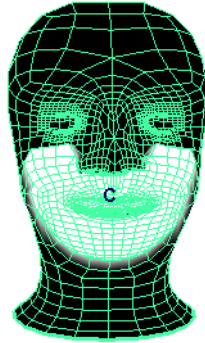

The white area shows the points that make up the cluster. The whiteness also indicates the weights—how much the points move in response to the movement of the cluster handle. White indicates a cluster weight of 1—the points move the same distance as the handle. By default, each point has a weight of 1.

Black indicates a cluster weight of 0. The points do not move in response to cluster handle movement. Note that regions that are not part of the cluster are also black.

Although there are no gray regions currently, gray means the movement is partial. The lighter the gray, the more the movement. Gray regions indicate a cluster weight between 0 and 1.

- 3** In the Paint Attribute Section of the Tool Settings window, set the following:
 - Paint Operation: Replace
 - Value: 0.5
- 4** Click the Flood button.

This gives all the cluster points a weight of 0.5. The white region is now gray:

7 | Character Setup

Lesson 3 > Editing cluster weights

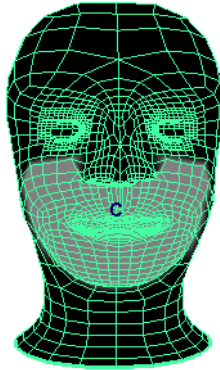

The selected vertices move down a bit, as the weight of 0.5 lessens the effect of the prior movement of the cluster by 50%.

- 5** To check the shape with full-color shading, click the Select Tool. (You might also prefer to cancel the selection of smilingFace to eliminate the display of the highlighted wireframe.)
- 6** To return to the Paint Cluster Weights Tool, select smilingFace and Deform > Paint Cluster Weights Tool > again.
- 7** In the Tool Settings window, make these settings:

Radius(U): 0.1

Opacity: 0.3

Paint Operation: Replace

Value: 1

The settings have this effect when painting:

A Radius(U) of 0.1 sets the radius of the region affected by the stroke. The red circle icon on the face displays the radius.

An Opacity of 0.3 scales down the effect of painting weight values so you can build up values gradually with repeated strokes.

A Replace operation paints the Value specified on the points stroked.

A Value of 1 sets the weight value you paint on the points.

- 8** Paint the region at the corners of the mouth with repeated strokes until the face looks roughly like the following figure. If your results differ from the figure significantly, undo the strokes and try again.

7 | Character Setup

Lesson 3 > Editing cluster weights

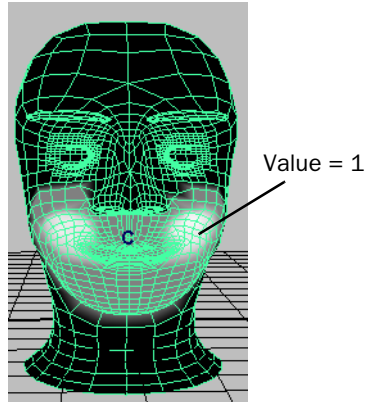

While painting weights, it's useful to intermittently check the shape with full-color shading rather than with the grayscale shading. To do this, click the Select Tool to turn off the Paint Cluster Weights Tool. (You might also prefer to cancel the selection of smilingFace to eliminate the display of the highlighted wireframe.)

- 9 Enter a Value of 0.25 and paint the central region above and below the lips as follows:

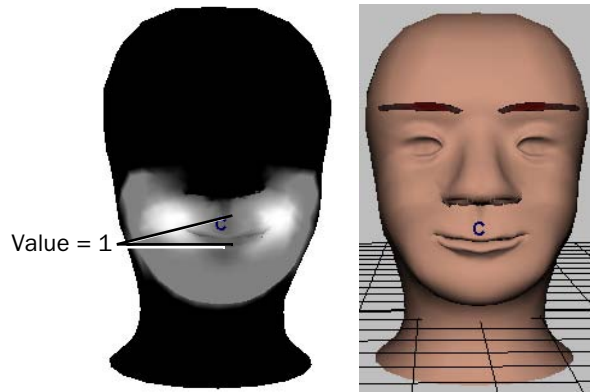

7 | Character Setup

Lesson 3 > Creating a blend shape

Because the corners of the mouth have a high weight and the central region around the lips have a low weight, the corners move up more in response to the prior positioning of the cluster handle. This creates a smiling mouth. The cheeks and chin have a medium weight, so they also move up slightly also. (For many people, skin at the chin and neck moves during smiling.)

- 10** In the Tool Settings window of the Paint Cluster Weights Tool, set the Paint Operation to Smooth. Paint any region where the surface has become irregular. Irregular regions are typically indicated by jagged wireframe curves (isoparms) or where a grayscale color makes an abrupt change to a lighter or darker color. Smoothing averages the weights of the stroked points with the weights of the surrounding region. The Value setting has no effect on smoothing.
- 11** Replace and smooth weights in other regions of the face until you are satisfied with the smile. For example, you might want to reduce the weight values at the side of the nose and immediately below the nose.

Your smilingFace should now have a slight smile as a result of your cluster weight edits.
- 12** Hide the Paint Attributes Tool settings window.

Creating a blend shape

In this section, you create a blend shape deformer to control the smile on baseFace (base object) using the smilingFace (target object). A blend shape deformer is ideal for facial animation, where you need a number of facial positions to be readily available for use in an animation sequence. With a blend shape deformer, you can set up a character's face to blend between a smile, frown, smirk, and so on.

In the next steps, you create a blend shape deformer to change the baseFace into the smile of smilingFace.

To create a blend shape deformer

- 1** In the Outliner, select smilingFace and ctrl-select baseFace, specifically in this order.

7 | Character Setup

Lesson 3 > Creating a blend shape

The smilingFace (the first selection) is called the target object, while baseFace (the second selection) is called the base object. The objective of a blend shape operation is to morph the base shape into the target shape.

- 2 Select Deform > Create Blend Shape > .
- 3 In the Blend Shape node text box, type `blendShape`, then click Create.
- 4 Select Window > Animation Editors > Blend Shape. This displays the Blend Shape editor, which has a slider for changing the base into the target shape, and buttons for setting keys.
- 5 Cancel the selection of the faces so you can see the surfaces without the obscuring highlighted wireframe.
- 6 Drag the slider from 0 to 1 to morph the baseFace into the target, smilingFace.

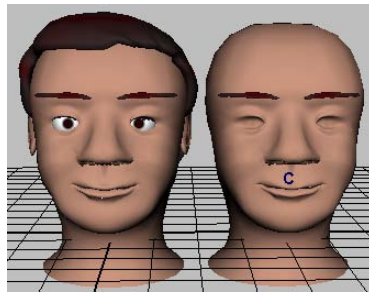

Note that you can click the Key button below the slider to set an animation key for the shape of the face at the current frame. By setting a few keys with different slider values at different points in the timeline, you can animate from the neutral expression to a full or partial smile or vice versa.

When you key the shape, Maya applies the key to the blendShape node that was created when you selected Deform > Create Blend Shape > . If you need to select the blendShape node, for instance, so you can see or delete the keys in the Time Slider, click the Select button in the Blend Shape editor.

7 | Character Setup

Lesson 3 > Refining deformation effects

Refining deformation effects

The combination of a cluster and blend shape is ideal for facial animation because it lets you tune various subtle deformations. A few common techniques follow.

- In the box below the slider of the Blend Shape editor, you can enter a numerical value below 0 to invert the deformations, or above 1 to amplify the deformations. For example, -1 creates a frown, while 1.6 creates a brimming smile:

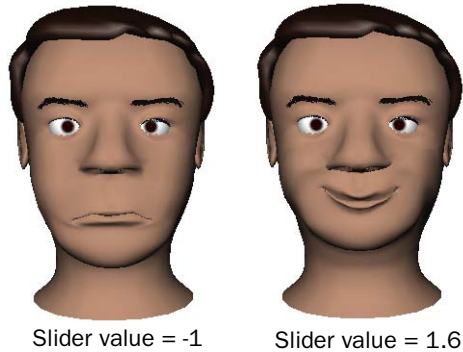

- With or without changing the Blend Shape slider, you can move, rotate, and scale the cluster handle to modify the blend shape. The following figure shows some examples. The face you created will be slightly different because your original smile is different.

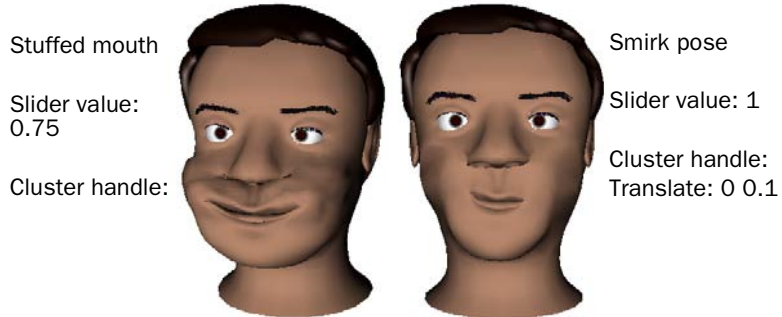

- You can use the Paint Cluster Weights tool again to change cluster weights when the cluster and blend shape editing deforms certain regions undesirably or doesn't give the exact look you desire. You can also use Ctrl - Z (Windows and Linux) or Control-z (Mac OS X) to undo any undesired changes.

Adding target objects to an existing blend shape

In the next steps, you duplicate the face again and reshape the duplicate into a new facial expression. You then add the new face to the blend shape node to create another slider in the Blend Shape Editor.

To create another facial expression

- 1 Set the Blend Shape editor slider value to 0 to return baseFace to the position it had at the beginning of the lesson.
- 2 Make a duplicate of baseFace, name it raisedBrow, and move it to the left of baseFace so that all three faces are visible for comparison.

7 | Character Setup

Lesson 3 > Adding target objects to an existing blend shape

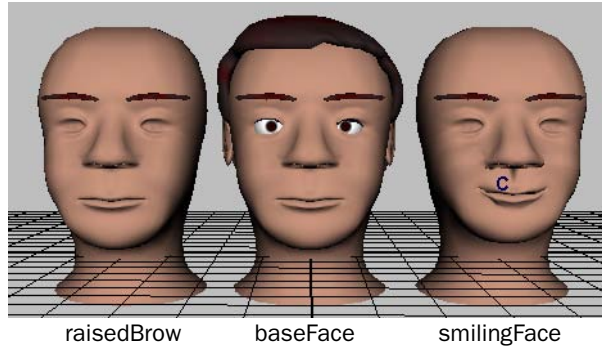

- 3** Make sure raisedBrow is selected.
- 4** In the perspective view, select Show > Isolate Select > View Selected. Select this menu item again in the front view.
This displays only the selected object (raisedBrow) in the views. This is necessary to avoid selecting unwanted vertices in the next steps. The view's label indicates isolate is turned on.
- 5** In the front view, position the pointer over the face, right-click and select Vertex. Drag a selection box around the vertices in the region of the eyebrows and forehead as shown below.

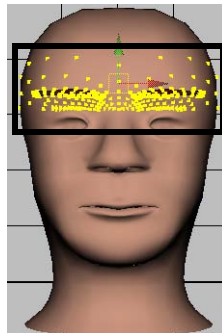

Drag a selection box around these vertices

7 | Character Setup

Lesson 3 > Adding target objects to an existing blend shape

For these vertices, you need to select the vertices by dragging a selection box rather than by using the Paint Selection Tool. The eyebrows have vertices that lie behind its outer surface. The Paint Selection Tool selects only vertices at the outer surface. Dragging a selection box selects all vertices in the boxed region, including vertices that lie behind the outer surface.

- 6** In the side view, hold down the Ctrl (Windows and Linux) or Control (Mac OS X) key and drag a selection box around the vertices at the side of the head to turn off their selection (see the following figure).

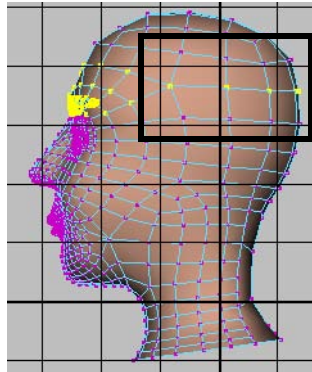

Hold down the Ctrl or Control key and drag a selection box around these vertices to cancel their selection.

- 7** Switch to wireframe display mode and dolly the camera from various close-up views to make sure you select all the vertices on and under the eyebrow. If you miss a few vertices, subsequent deformations will not work correctly. Also, make sure you don't select vertices at the side or back of the head.
- 8** Select Deform > Create Cluster.
- 9** In the perspective view, turn off the selection of Show > Isolate Select > View Selected. Do this again in the front view.
By turning off these menu selections, Maya displays all objects in the views again.
- 10** In the perspective view, drag the cluster up along its Y-axis a small amount until raisedBrow looks like the face on the left:

7 | Character Setup

Lesson 3 > Adding target objects to an existing blend shape

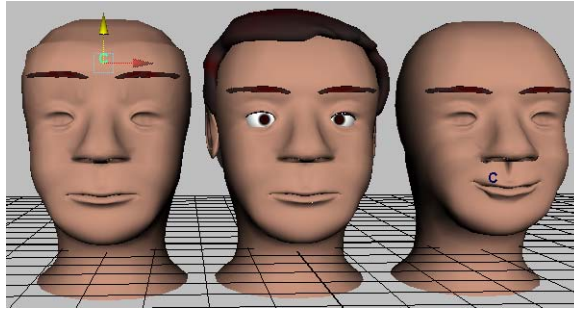

To add the new target object to the blend shape

- 1** In the Outliner, select raisedBrow and ctrl-select baseFace (the order of selection is important). The raisedBrow is the target, while baseFace is the base object.
- 2** Select Deform > Edit Blend Shape > Add > . In the options window, turn on Specify Node and enter blendShape in the BlendShape Node box. Click the Apply and Close button.

When you created the blend shape for the smile, Maya created a node named blendShape that contains the slider attributes that adjust the blend into the smilingFace target. The Add operation creates a blend shape for the raisedBrow and adds it to the blendShape node. This adds a slider to the node's Blend Shape editor for adjusting the raised brow deformations.

- 3** To display the Blend Shape editor, select Window > Animation Editors > Blend Shape.

7 | Character Setup

Lesson 3 > Adding target objects to an existing blend shape

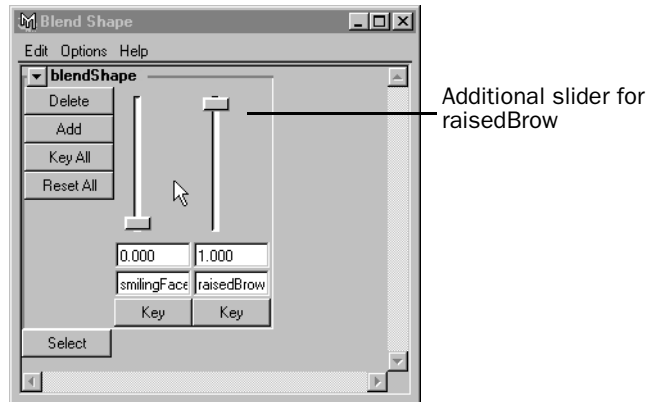

- 4 You can use the sliders alone or in combination to create a smile with raised eyebrows, a frown with lowered eyebrows, and so on.

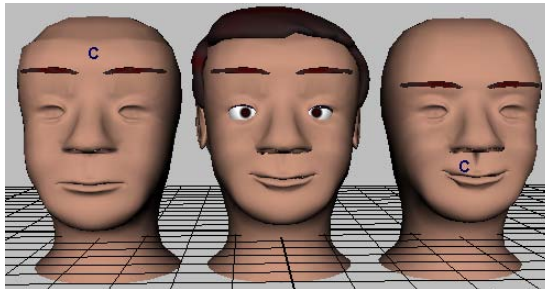

- 5 You can optionally select raisedBrow and edit the cluster weights to tune the deformation of the eyebrow region as desired. See "Editing cluster weights" on page 326 for details. An example weighting follows:

7 | Character Setup

Lesson 3 > Beyond the lesson

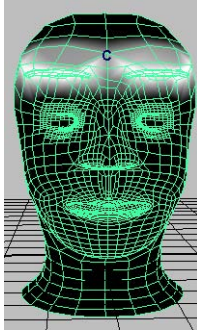

Tip

After you create a blend shape, you can optionally hide or delete a target object (in this lesson, `smilingFace` and `raisedBrow`). If you delete a target, you improve Maya processing time but lose the capability to manipulate the cluster handle. For versatility, many animators hide the target rather than delete it. Hiding the target is necessary when you render the scene. It is also useful when you want to unclutter the scene view.

Beyond the lesson

In this lesson, you learned how to:

- Use two clusters and a blend shape deformer to manipulate facial expressions.

In professional productions, it's common to create several more clusters with a blend shape deformer for finer control of facial expressions. For example, you can create clusters for a number of mouth positions that you can use to simulate the phonemes of speech.

When you used certain blend shape slider values, you may have noticed that the face looked good in all regions except for a few vertices. To fix such regions, delete the cluster, move the problem vertices of the target face to a better position, then create a blend shape for the improved target face.

As much as possible, use a target shape that's not extremely different from the base shape. If you need to use an extremely different target shape, create a blend shape with multiple targets. Each of the multiple targets must have a shape that is progressively more like the extreme target shape. Before you create the blend shape, turn on In-Between in the Create Blend Shape options window, and select the multiple targets in this order: least extreme shape difference first, most extreme shape difference last.

Although the lesson showed how to blend individual objects, you can also blend hierarchies of objects. See the Maya Help for more information.

There are some additional notes on clusters which are not explained in this lesson:

- You can add or remove vertices from a cluster with Deform > Paint Set Membership Tool.
- You can use the Component Editor to edit weight values more precisely than by painting.
- Avoid changing the number of vertices (or CVs) for a surface after you apply a cluster or other deformer. Unexpected deformations may occur.

7 | Character Setup

Lesson 3 > Beyond the lesson

8 Polygon Texturing



Texture maps let you modify the appearance of your 3D models and scenes in Maya. *Texture maps* are images you apply and accurately position onto your surfaces using a process called *texture mapping*. When an image is texture mapped onto a surface, it alters the appearance of the surface in some unique way. Texture maps let you create many interesting visual effects:

- You can apply labels and logos to your surfaces using texture maps.
- You can apply surface relief details and features to a surface instead of having to model the details on the surface directly.
- You can use illustrations as texture maps to create interesting backdrops in your scenes.

Most shading attributes for a surface material can be altered by a texture map. (For example, color, specular, transparency, and reflectivity are examples of attributes that can be modified by a texture map.)

Texture mapping is a key component in the 3D production workflow. Many production environments employ texture artists whose only role is to create and apply the texture maps to 3D models.

8 | Polygon Texturing

> Preparing for the lesson

Preparing for the lesson

To ensure the lessons works as described, do these steps before beginning:

- 1 Select File > New Scene to create a new scene.
- 2 Make sure the Construction History icon (below the menu bar) is on: . (If it is turned off, it has a large X across it.)
- 3 Select the Modeling menu set. Unless otherwise noted, the directions in this chapter for making menu selections assume you've already selected the Modeling menu set.
- 4 Make sure Display > UI Elements > Help Line is turned on. You will use the Help Line while modeling.

Lesson 1 UV texture mapping



There are several techniques for texture mapping 3D surfaces depending on the surface type (NURBS, polygons, subdivision surfaces). Some techniques involve preparing the surfaces for texture mapping. For example, when texture mapping polygonal and subdivision surface types you need to understand how textures are applied using UV texture coordinates.

UV texture coordinates, or *UVs* as they are more commonly called, are two-dimensional coordinates that reside with the vertex component information for a 3D surface. UVs control the placement of a texture map on a 3D model by correlating the pixel position of the 2D texture map to the vertex positions on the model, so that the texture gets positioned (mapped) correctly.

For NURBS surfaces which have an inherent rectangular topology, the UV texture coordinates are implicit. That is, the UVs reside in the same location as the control vertices, so have a natural correlation to a rectangular shaped texture map.

For polygonal and subdivision surface type models, which have an arbitrary surface topology, the UVs can be explicitly created and modified to suit the requirements of the texture map.

8 | Polygon Texturing

Lesson 1 > Creating a cracker box model

In this lesson you'll learn the basic principles of UVs by applying (mapping) an existing image (texture) to a simple polygonal model and creating and modifying the UV texture coordinates so that the texture map appears correctly on the surface.

In this lesson you learn how to:

- Assign a 2D texture map to a polygonal model.
- Map UV texture coordinates (UVs) to a polygonal surface.
- Correlate the UVs between the scene view and the UV Texture Editor.
- Use the UV Texture Editor to visualize how the UV texture coordinates from a three-dimensional model relate to an assigned two-dimensional texture map.
- Determine basic UV layout requirements.
- Set preferences to let you visualize the texture borders in both the UV Texture Editor and the scene view to better understand how the texture map is placed on the polygonal model.
- Select and reposition UV texture coordinates within the UV Texture Editor using the transformation tools to make the UVs match a pre-defined texture map.
- Sew UV texture coordinates to existing UV shells.

Creating a cracker box model

You begin the lesson by creating a model of a cracker box using a polygonal cube primitive. The dimensions you'll use for the cracker box are based on a texture map you'll apply to the model in this lesson.

To create a cracker box model using a cube primitive

- 1 Select Create > Polygon Primitives > Cube > .
- 2 In the Polygon Cube Options window, select Edit > Reset Settings, set the following options, and then click Create:
 - Width: 8
 - Height: 10

8 | Polygon Texturing

Lesson 1 > Applying a texture map to a polygon mesh

- Depth: 3
- Subdivisions Along Width: 1
- Subdivisions Along Height: 1
- Subdivisions Along Depth: 1
- Axis: Y
- Texture: Normalize the Whole Object

A cube primitive in the shape of a rectangular box appears in the scene view.

The *Normalize the Whole Object* option ensures that the primitive object is created with a set of default UV texture coordinates. All polygonal primitives in Maya provide an option for creating UV texture coordinates at the time of creation.

- 3 Using the Channel Box, set the Translate Y attribute to 5 so that the cracker box is repositioned to rest on the X axis.
- 4 Rename the pCube1 primitive to: `cracker_box`.

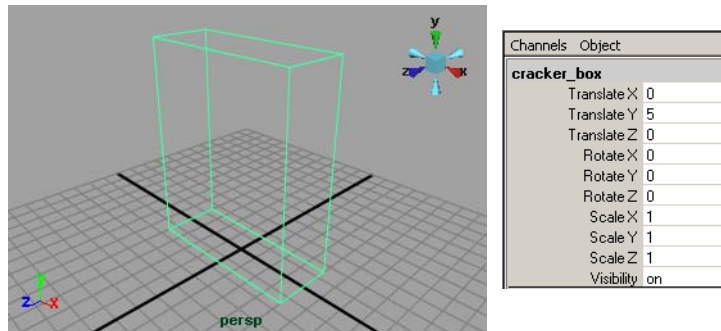

Applying a texture map to a polygon mesh

In Maya, surfaces appear in a rendered image based on the shading materials you apply to them. The default shading material that gets assigned to surfaces provides basic attributes such as color, transparency, and incandescence.

8 | Polygon Texturing

Lesson 1 > Applying a texture map to a polygon mesh

Depending on your final image requirements, you can enhance the visual impact of an object by adding one or more texture maps to the assigned shading material. One basic texture map you can apply is a bitmap image also referred to as a *file texture*. In this lesson, you apply a texture map we've created for your use on the cracker box.

For more basic information on shading materials and texture maps see the *Rendering* chapter of this guide and the Maya Help.

To assign a shading material to the cracker box

- 1 In the scene view, select Shading > Smooth Shade All from the panel menu. This displays the cracker box with a default gray, smooth shading material, lit using default lighting. Turning on Smooth Shade All displays the assigned shading material you apply to the cracker box in the steps following.

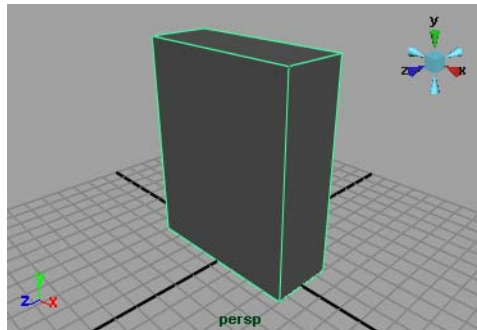

- 2 In the scene view, right-click on any region of the cracker box and select Materials > Assign New Material > Lambert from the marking menu. A new Lambert shading material is created and assigned to the cracker box. The Attribute Editor appears and displays the various attributes for the new Lambert shading material.

8 | Polygon Texturing

Lesson 1 > Applying a texture map to a polygon mesh

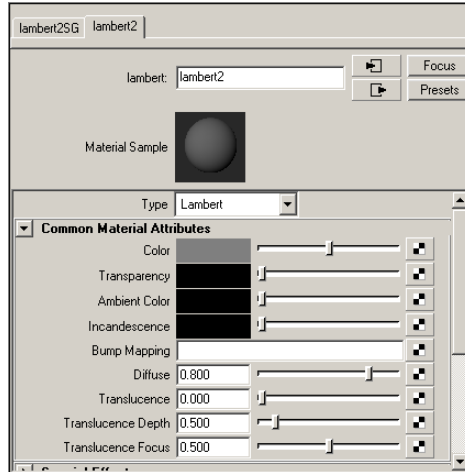

The new Lambert material is identical to the default gray material that was previously assigned to the cracker box. However, it's always a good practice not to modify the default shading material in the scene and create a new shading material and modify it to suit your requirements.

- 3 In Attribute Editor, double-click in the *lambert2* box and then type: `box_material` to rename the shading material.

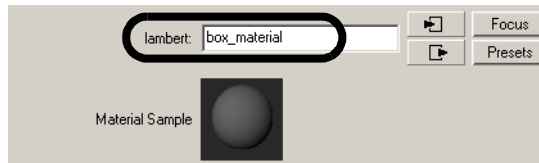

Renaming the shading material lets you easily identify it later on when you need to edit it. Naming items uniquely in Maya is a useful habit.

- 4 In the Attribute Editor, move the *Color* slider fully to the right so that the color box appears white.

8 | Polygon Texturing

Lesson 1 > Applying a texture map to a polygon mesh

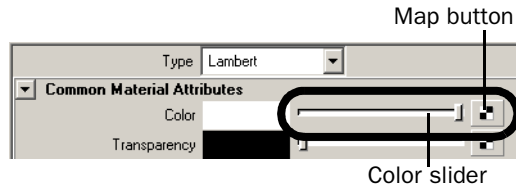

The shading material assigned to the box model also updates in the scene view so it appears in a brighter tone.

- 5 Click the Map button located to the right of the Color slider.
The Create Render Node window appears and lists the various texture options you can apply (or connect) to the color channel of the box material.
- 6 Click PSD File from the list of 2D Textures.

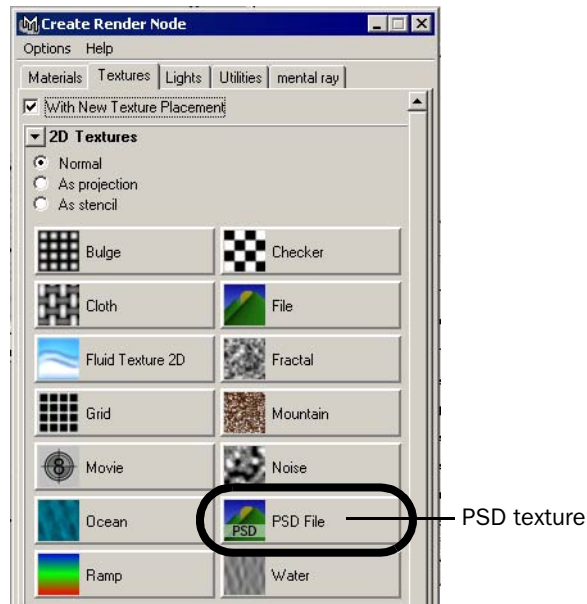

8 | Polygon Texturing

Lesson 1 > Applying a texture map to a polygon mesh

Choosing this option specifies that you want to apply an Adobe® Photoshop® format file as a texture. A PSD format file lets you keep the various components of your texture map on multiple unmerged layers. This is useful when you need the ability to edit a component of the texture during production.

The Attribute Editor updates to display the options for the PSD File texture.

Tip If the Attribute Editor suddenly appears empty, it indicates that no objects are selected in the scene. Simply select the box model again in the scene to display the attributes for the box.

- 7 Click the Browse button (folder icon) to the right of the Image Name attribute to specify the image file for the texture map.

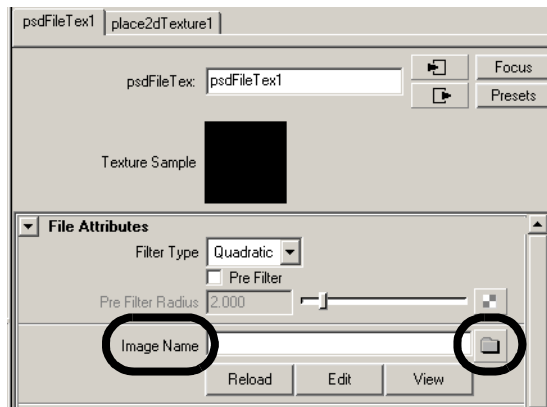

A browser window appears with the path set to the default project directory. By default, Maya looks for source images for texture maps in a `sourceimages` folder whenever the project folder is set. Maya can use file texture images from anywhere on your workstation or local network. For example, you can have images on a central disk drive that is shared among users in a production environment.

8 | Polygon Texturing

Lesson 1 > Applying a texture map to a polygon mesh

- 8 Select the image file named `UVLesson.psd` that is provided on the *Maya Documentation, Lessons, and Extras* CD and then click Open.

The image is on the *Maya Documentation, Lessons, and Extras* CD in the following path: `GettingStartedLessonData/Rendering/sourceimages`

The image contains 2D artwork for the front, back, top, bottom, and sides of the cracker box that was generated in Adobe® Photoshop®.

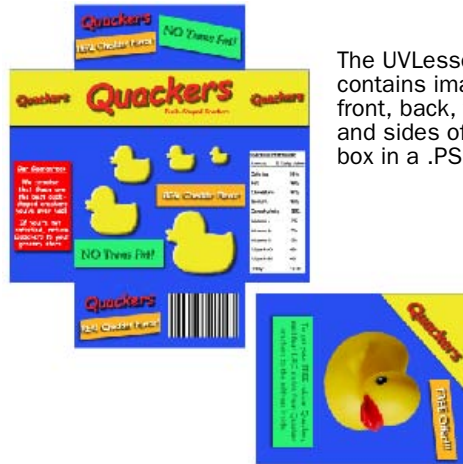

The UVLesson file contains images for the front, back, top, bottom, and sides of the cracker box in a .PSD format file.

A small preview of the image appears in the Texture Sample box in the Attribute Editor.

When a texture is applied to a shading material its attributes get added to the existing attributes for shading material. That is, all of the existing shading attributes remain unchanged except for the attribute that gets modified by the texture. In this case, the grey color is substituted by the image of the cracker box artwork.

- 9 In the scene view, select **Shading > Hardware Texturing** from the panel menu to display the texture map on the cracker box model.

8 | Polygon Texturing

Lesson 1 > Viewing UVs in the UV Texture Editor

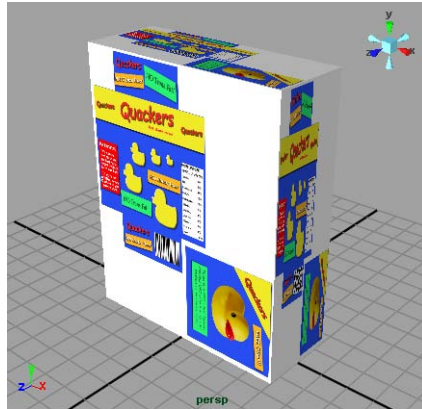

The texture map does not appear correct on the box because the UVs for the model don't correlate to the texture map that was supplied.

The texture map does not appear correctly on the cracker box model. The texture map was designed so that specific sides of the box receive specific regions of the image. Instead, the complete image is being placed on every side of the object.

To correct this problem you must modify the UV texture coordinates for the model so they match the layout of the texture image. To do this, you use the UV Texture Editor.

Viewing UVs in the UV Texture Editor

The UV Texture Editor lets you view and interactively edit the UV texture coordinates for polygon and subdivision surface types. UVs appear laid flat within the UV Texture Editor's 2D view. It also lets you display the 2D image for the texture map in relation to the UVs. These features are critical for accurate and efficient placement of texture maps on polygon and subdivision surface types.

In this lesson, your goal is to ensure that the shape and placement of the UVs match the image as it appears in the 2D view of the UV Texture Editor. This will ensure that the map appears correctly on the cracker box model in the 3D scene view.

8 | Polygon Texturing

Lesson 1 > Viewing UVs in the UV Texture Editor

To open the UV Texture Editor in a two pane layout

- 1 In the scene view, right-click any of the Quick Layout buttons on the Toolbox to display the pop-up menu of Quick Layout shortcuts and select *Persp/UV Texture Editor* from the list.

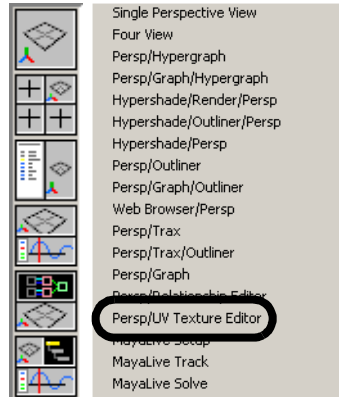

Right-click any of the Quick Layout buttons to view the pop-up menu and select *Persp/UV Texture Editor*.

The panel layouts update to display the Perspective view in the left pane and the UV Texture Editor in the right pane simultaneously. (You can close the Attribute Editor if it is still displayed.)

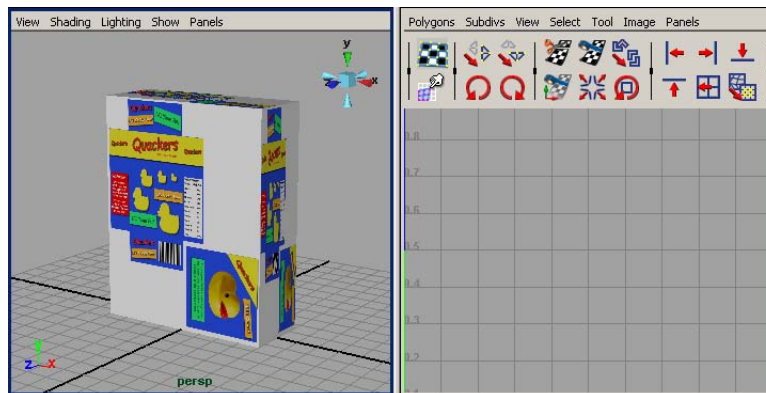

Perspective view

UV Texture Editor

8 | Polygon Texturing

Lesson 1 > Viewing UVs in the UV Texture Editor

This two pane layout is helpful for two reasons:

- The two view layout shows you how one item selected in the 3D view relates to the UVs displayed in the 2D view of the UV Texture Editor and vice versa, without having to open and close the views repeatedly.
- When you edit UVs for a surface mesh in the UV Texture Editor, you can immediately see the effect on the texture map on the model in the 3D scene view.

UVs do not initially appear in the 2D view of the UV Texture Editor until you select an object or change the selection mode for an object in the scene view.

To view UVs in the UV Texture Editor

- 1 In the scene view, right-click any region of the cracker box model and select Object Mode from the marking menu.

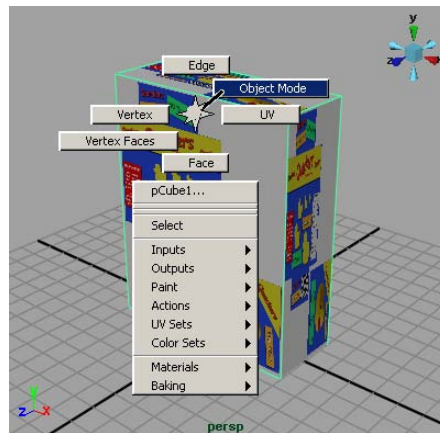

- 2 Select the cracker box model.
- 3 In the UV Texture Editor, dolly the view outwards so you can see the UVs for the cracker box as shown below. (To dolly, press the Alt key and drag the mouse to the left while holding down the right button on your mouse.)

8 | Polygon Texturing

Lesson 1 > Viewing UVs in the UV Texture Editor

The UV texture coordinates for the cracker box model appear in the 2D view of the UV Texture Editor as a flattened, two-dimensional representation. The UVs appear highlighted with lines connecting the UVs to indicate the region of the texture the UVs represent.

The image you specified as the texture map for the box also appears in the 2D view of the UV Texture Editor in the upper right quadrant of the 2D cartesian graph called the *UV image range* or *UV Texture Space*. The coordinates for this quadrant range from 0, 0 to 1,1 and represent the texture space for the surface. How the UVs appear in this quadrant in relation to the displayed image has a direct bearing on how the texture gets mapped onto the surface.

Tip

If the texture map for the cracker box doesn't appear in the 2D view, select Image > Update PSD Network in the UV Texture Editor to refresh the 2D view of the UV Texture Editor. Update PSD Network is normally used to refresh a PSD texture in Maya after you have modified the PSD texture in Adobe® Photoshop® .

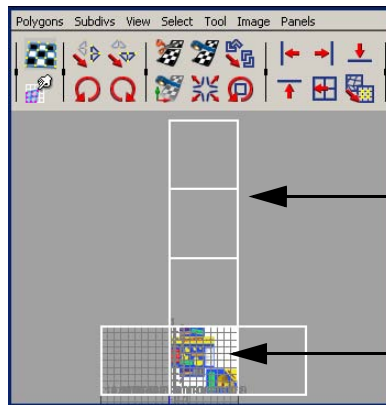

The default UVs for the model extend beyond the texture area (known as the 0 to 1 UV range).

The texture map appears in the 0 to 1 range of the UV Texture Editor.

In this example, the UVs for the cracker box appear like a box where all six sides have been cut open and then unfolded flat.

The texture map does not appear correctly on the cracker box for a number of reasons:

- The UVs for the cracker box extend well beyond the default 0 to 1 UV range for the texture map in the 2D view of the UV Texture Editor. As the texture map displays within the 0 to 1 range, the UVs should also be positioned to fit within the 0 to 1 UV range, in most cases. Otherwise, the texture map repeats on the surface mesh, as it does in this case.
- The position of the UVs do not match the specific regions of the image we've provided for the texture map. The regions of the image show the front, back, top, bottom, and sides of the box. The UVs should specifically match these regions to display the texture correctly. UVs do not automatically align themselves to a texture, you must manually reposition them.
- The shape of the UVs don't match the aspect ratio of the cracker box model in the scene view: -10 (Height) X 8 (Width) X 3 (Depth). This is because the default UVs for a Maya cube primitive are created based on a predetermined default shape and do not get updated if the shape or scale of the primitive is modified later on.

There are a number of things you can do to correct these issues depending on the situation. For this lesson, you will correct the UV and texture map misalignment by doing the following:

- Map a new set of UVs for the cracker box model that better matches the individual faces of the cracker box. (While the existing UVs could be modified, you'll learn how to create new UVs in this lesson that will better match the size and scale of the 3D model.
- Ensure the new UVs fit within the 0 to 1 UV range in the UV Texture Editor.
- Reposition the UVs so that they correlate to specific locations on the 2D image using the UV Texture Editor. This will ensure that the various sides of the box receive the correct regions of the texture map.

Mapping UV texture coordinates

It is often necessary to create new UVs for a surface mesh in order to texture map it correctly. These situations include:

8 | Polygon Texturing

Lesson 1 > Mapping UV texture coordinates

- Texture mapping a surface that doesn't have existing UVs.
This can occur when you import 3D models from other software applications that don't create UVs.
- When the UVs for a surface are badly jumbled or are missing some UVs.
This can occur when a surface has been edited or modified in some way and it becomes hard to determine what UVs may be missing as a result.
- When you need a unique set of UVs for a particular purpose.
For example, if you want to paint a texture map directly onto a 3D surface, you may want to map UVs that allow you to paint using the 3D paint tools in Maya. Alternatively, you may want to create a unique set of UVs specifically for baking textures or light maps.

Maya lets you create UVs for polygonal and subdivision surfaces using a process called *projection mapping*, sometimes referred to as *mapping UVs*. Maya provides several projection mapping types that map what gets viewed by a particular projection to a flat 2D view that can be subsequently correlated to your texture map using the UV Texture Editor.

In this lesson, you use a feature called *Automatic Mapping* to create new UVs for the cracker box model. Automatic mapping lets you specify the number of planes that will be used for the UV projection.

Automatic Mapping is normally used when mapping UVs that require multiple projections of organic shaped models as it has the advantage of producing UVs that are proportional in scale to the world space area of the mesh faces of the surface.

Automatic mapping is useful when your mapping requirements are for non-overlapping UVs which fit within the 0 to 1 texture space, but which do not have to be contiguous; for example, when using the 3D Paint tool, Maya® Paint Effects™, Maya® Fur™ or Maya® Hair™.

You use Automatic Mapping in this lesson because it can produce a UV projection from three planar directions simultaneously which makes it a good choice for the shape of the cracker box model. That is, you can map UVs for the front and back, top and bottom and the two sides in one operation. This projection type is referred to as a *triplanar projection*.

To map UVs using Automatic Mapping

- 1 In the perspective view, select the cracker box as an Object.
- 2 From the modeling menu set, select Polygon UVs > Automatic Mapping > . The Polygon Automatic Mapping Options window appears.
- 3 In the Polygon Automatic Mapping Options window, select Edit > Reset settings, set the following options, and then click Project:
 - Planes: 3
 - Percentage Space: 2

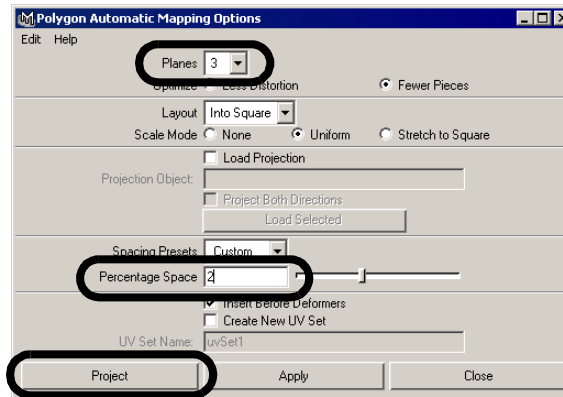

Setting *Planes* to 3 creates UVs based on projections from three separate directions. Setting the *Percentage Space* option to 2 sets the size of the space that appears between each of the separate UV projections when they are laid out in the UV Texture Editor.

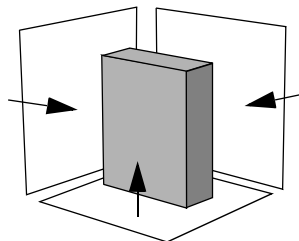

A triplanar UV projection creates UVs based on 3 projection planes.

8 | Polygon Texturing

Lesson 1 > Mapping UV texture coordinates

When the projection is complete the new projected UVs from the triplanar projection appear in the UV Texture Editor.

Note Whenever a UV projection is performed on a surface, any existing UVs for the surface get replaced by the UVs from the new projection. To avoid replacing existing UVs you can explicitly save the UVs in a UV set. For more information on UV Sets see the *Modeling* guide in the Maya Help.

- 4 In the UV Texture Editor, dolly the view so it shows only the 0 to 1 UV range area that displays the image for the texture map and the new UVs (as shown below).
- 5 In the UV Texture Editor, select Image > Dim Image.

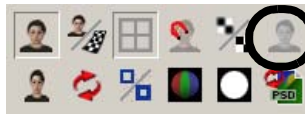

Dim Image button

The intensity of the image map is reduced so you can view the UV borders on the projected UVs more easily. The new UVs appear in the UV Texture Editor as shown below.

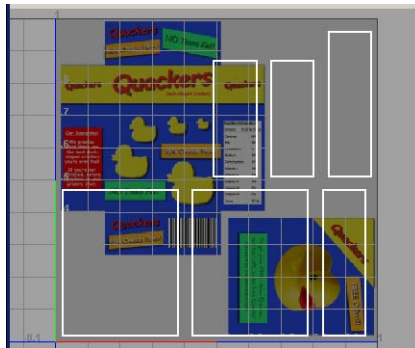

- The six rectangular UV shapes, referred to as *UV shells* or simply *shells*, now match the aspect ratio for each of the six sides of the cracker box better than the earlier UVs.
- The UV shells fit within the 0 to 1 UV texture range. Automatic mapping fits the UVs to the 0 to 1 range by default.

The texture map still does not appear correctly on the cracker box because the UV shells need to be repositioned so they align with the corresponding components of the image map.

While the shape of each UV shell is now recognizable as being associated with the cracker box, it is not apparent which components in the UV Texture Editor correspond to a particular face on the cracker box.

In the next section you learn how to select and reposition the UV shells so they better match the image for the texture map.

Working with UVs in the UV Texture Editor

When texture mapping a polygon or subdivision surface type model it is often necessary to modify the UV components for a model so they match the texture map. The UV Texture Editor provides many tools for working with UVs. In this section you learn how to:

- Select UVs from either the scene view or the UV Texture Editor and accurately correlate them. Selecting UV components is critical to modifying them accurately.
- Sew UV shells together to reduce the number of UV components you need to work with.
- Move and rotate UVs within the UV Texture Editor to make the UV shells align to the cracker box texture map.

Selecting UV components

You can select UV components from either the scene view or within the UV Texture Editor. Displaying both the 3D scene view and the 2D view of the UV Texture Editor lets you easily correlate which UV components are associated with a particular edge or vertex on the 3D model.

8 | Polygon Texturing

Lesson 1 > Working with UVs in the UV Texture Editor

This is very helpful to understand the layout and orientation of your UV texture coordinates in relation to the image used for a texture map and how the map appears on the model in the 3D scene view.

To select UVs for a 3D model in the scene view

- 1 In the UV Texture Editor, select Image > Display Image to turn off the display of the texture image.

Display Image works by turning the display of the assigned texture on or off in the 2D view of the UV Texture Editor. Turning the image off temporarily aids in viewing only the UV components. This will be useful in the steps that follow.

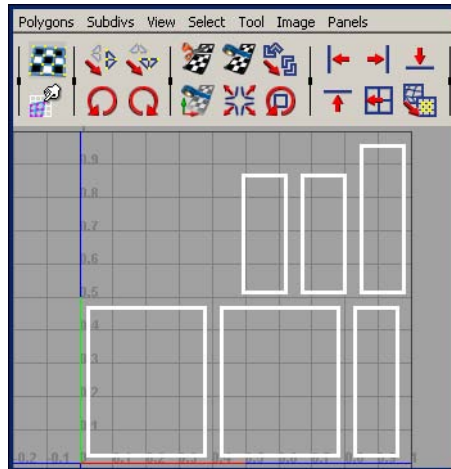

- 2 In the scene view, right-click on the cracker box model and select *UV* from the marking menu that appears.
- 3 In the scene view, select one UV on any corner of the cracker box.

Selecting a UV is very similar to selecting a vertex on an object. That is, you select a point that resides in exactly the same position as the vertex. When you select a UV in the scene view, the corresponding UV is also selected in the UV Texture Editor.

Note If more than one UV gets selected in the UV Texture Editor when you select a UV in the scene view it indicates that multiple UV components share the same UV on the 3D model (similar to how polygon faces share common vertices). This is important to remember when you move one of these UV components in the UV Texture Editor and other UVs also move.

- 4 In the scene view, right-click on the cracker box model and select Edge from the marking menu that appears.
- 5 In the perspective view, select the top front edge of the cracker box.

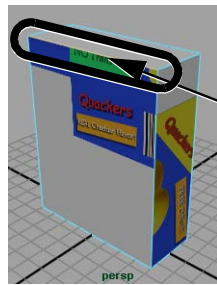

Select the top front edge of the cracker box in the perspective view.

When you select this edge in the scene view, notice that two corresponding shell edges also get selected in the UV Texture Editor. This indicates the following:

- The selected edge is shared by two faces; the front and the top.
- Selecting the top front edge in the scene view, identifies the corresponding front and top UV shells for the box. (indicated by the selection in the UV Texture Editor.)

This is useful when you need to understand how the various UV shells relate to each other, especially when you have many UV shells for a model in the scene; for example, when you sew two UV shell edges together.

In the steps that follow you select edges in the UV Texture Editor so you can sew them together.

8 | Polygon Texturing

Lesson 1 > Working with UVs in the UV Texture Editor

Sewing UVs

Sewing UV shells together merges the UV shells together along a shared edge that you specify. Sewing UVs is useful for the following reasons:

- You can move and modify the UV shells as larger contiguous texture units. This makes it more efficient to match the UVs to the texture in many situations.
- Texture maps can appear more uniform across texture borders when the texture is applied to one or more sewn UV shells compared to many separate UV shells. Sewing shells together reduces the chance that an unwanted texture mismatch occurs along the texture edge.

To sew shell edges together in the UV Texture Editor

- 1 In the scene view, ensure that only the top front edge of the cracker box is still selected.

When the top front edge is selected in the scene view, the top edge of one of the large UV shells is also selected as well as the left side of the middle UV shell in the top row of the UV Texture Editor. For the cracker box texture map, you need to sew these together so they correlate to the map correctly.

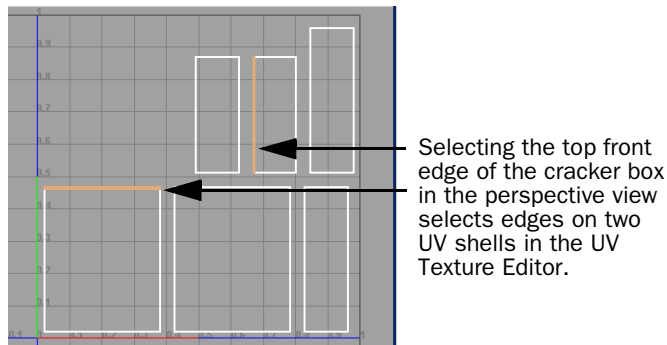

- 2 In the UV Texture Editor, select Polygons > Move and Sew UVs.

8 | Polygon Texturing

Lesson 1 > Working with UVs in the UV Texture Editor

The small rectangular UV shell is repositioned to match the top of the large UV shell and the two shells are combined into one. When you later select and move this sewn shell, it will move as one piece. When two UV shells are selected for sewing, the smallest UV shell is moved to the larger.

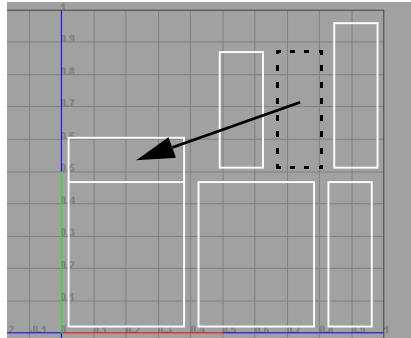

Move and Sew repositions one of the selected UV shells and merges the two shells into one.

- Repeat steps 1 and 2 for the remaining three edges on front face of the cracker box keeping in mind the following:
 - Select only one edge at a time in the scene view.
 - When you've completed the move and sew operation, your UV Texture Editor should show the front UV shell with the corresponding top, bottom, and side shells sewn to it. When fully complete, you will have only two UV shells to match to the texture image for the cracker box.

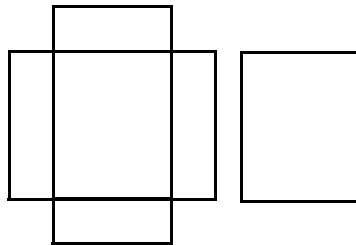

Two UV shells remain after the Move and Sew operations.

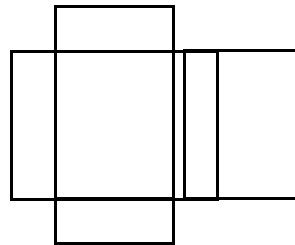

The UV shells will appear overlapping as shown above.

8 | Polygon Texturing

Lesson 1 > Working with UVs in the UV Texture Editor

- 4 To display the texture borders for the two shells, select Display > Custom Polygon Display > . (You can also launch this window by right-clicking the Toggle Texture Borders button.

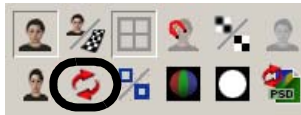

Toggle Texture Borders button

The Custom Polygon Display Options window appears.

- 5 In the Custom Polygon Display Options window, select Edit > Reset Settings, then set the *Highlight* option to *Texture Borders*, then click Apply and Close.

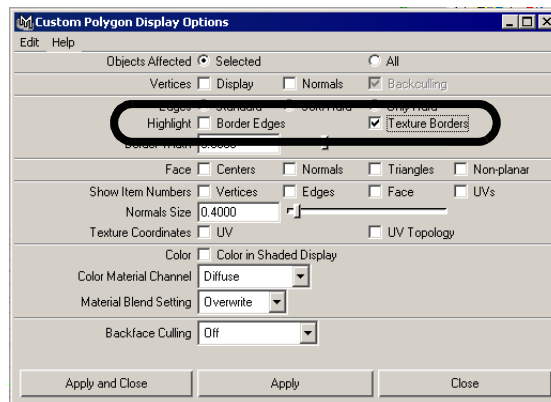

In the UV Texture Editor, the texture borders for two UV shells now appear with a thicker line.

8 | Polygon Texturing

Lesson 1 > Working with UVs in the UV Texture Editor

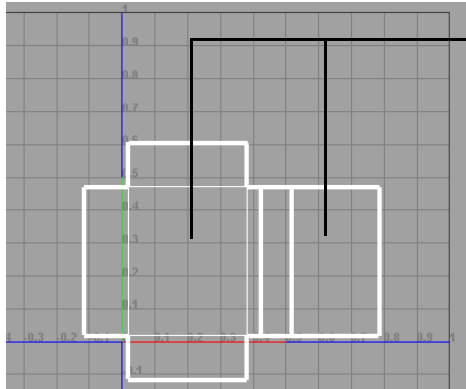

Two separate UV shells remain after sewing (the shells overlap in this image).

Displaying the texture borders on the UV shells aids in visualizing where the borders of the texture map will exist on the surface.

Displaying texture borders is useful for visualizing where the texture borders exist on the 3D model in the scene view. That is, any portion of the texture image that appears outside of the texture border will not appear on the surface. It is particularly useful for troubleshooting texture mismatches when they occur. Displaying the texture borders can also help to identify which UV shells are combined and which shells are not when you have many UV shells displayed in the UV Texture Editor.

In the steps that follow, you reposition the two UV shells in the UV Texture Editor so they coincide with the texture image.

Moving UV components

You manually reposition UV components in the UV Texture Editor using the tools within the Toolbox. To reposition an individual UV component you must first select it before selecting the Move Tool. To reposition an entire UV shell you must first select one individual UV from the shell it belongs to and then convert the selection to a shell before using the Move Tool.

To move UVs in the UV Texture Editor

- 1 In the UV Texture Editor, select Image > Display Image.

The texture image displays in the 2D view of the UV Texture Editor dimmed, as before. You need the image displayed so you can accurately reposition the two UV shells. Dimming the image aids in seeing the selected UVs.

8 | Polygon Texturing

Lesson 1 > Working with UVs in the UV Texture Editor

- 2 In the UV Texture Editor, right-click and select UV from the marking menu that appears.
- 3 In the UV Texture Editor, select one UV on the UV shell you sewed earlier in the lesson.

The UV coordinate appears highlighted in the 2D view.

- 4 Convert the selection to a UV shell by pressing the Ctrl key and right-clicking in the 2D view of the UV Texture Editor. Choose *To Shell* from the marking menu that appears.

The selection changes from a single selected UV to selecting the entire UV shell.

- 5 From the Toolbox, select the Move Tool.

The Move Tool manipulator icon appears over the selected UV shell.

- 6 Drag the green (Y axis) and red (X axis) Move Tool manipulator handles to reposition the UV shell so it matches the displayed texture image.

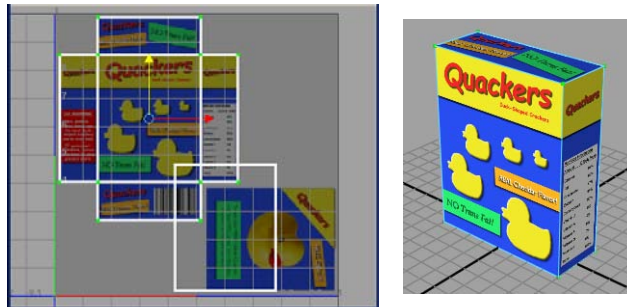

Repositioning the UV shell to match the texture image repositions the texture map on the 3D model.

The position of the texture updates on the cracker box model in the scene view as you do this.

- 7 Select one UV on the other remaining UV shell.
The UV coordinate appears highlighted.
- 8 Convert the UV selection to a shell selection by pressing the Ctrl key and right-clicking in the UV Texture Editor. Choose *To Shell* from the marking menu that appears.

8 | Polygon Texturing

Lesson 1 > Working with UVs in the UV Texture Editor

The selection changes from a single selected UV to selecting the entire UV shell.

- 9 In the UV Texture Editor's toolbar, click one of the Rotate UVs buttons to rotate the UV shell so it appears in the same orientation as the texture image. (Click the other Rotate UVs button to rotate it in the opposite direction.)

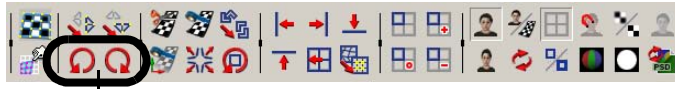

Click the Rotate UVs buttons to rotate the UV shell.

- 10 Confirm that the texture appears correctly on the cracker box model in the scene view by tumbling the scene so you can view the back of the box.

Tip If the texture appears upside down, you can continue to rotate it another 180 degrees. If the texture appears reversed, that is, the letters are backwards, you can correct this by selecting Polygons > Flip UVs from the UV Texture Editor menu and choosing the appropriate option setting.

- 11 From the Toolbox, select the Move Tool.
A move manipulator icon appears over the selected UV shell.
- 12 Drag the green (Y axis) and red (X axis) manipulator handles to reposition the UV shell so it matches the displayed texture image.
The texture map should now appear correct on all sides of the cracker box when you're finished.

Tip You can confirm that the UV shells are positioned accurately by dollying in closer on the 2D view of the UV Texture Editor. If a minor correction is required, simply select and move the UVs or move the entire UV shell.

8 | Polygon Texturing

Lesson 1 > Beyond the lesson

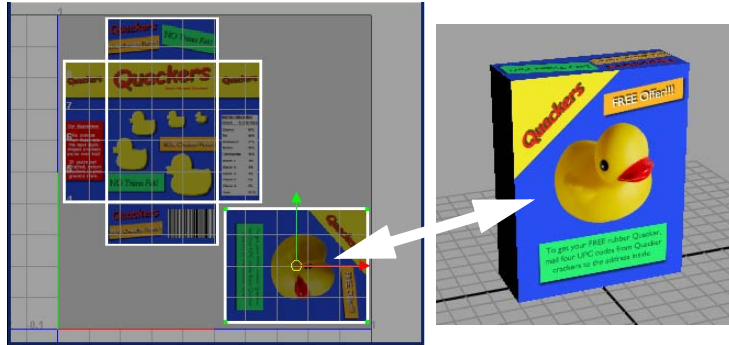

Repositioning the remaining UV shell to match the texture image repositions the texture map on the back face of the 3D model.

Tip

The exact UV boundaries can be viewed more clearly when the anti-aliasing for the texture image is temporarily turned off. To do this, select Image > Display Unfiltered to view the texture image without anti-aliasing.

If you need to move a single UV so it precisely matches a particular location on the texture map you can turn on Pixel Snap (Image > Pixel Snap). When you select and move the UV using the Move Tool, it will reposition the UV coordinate based on pixel boundaries.

Beyond the lesson

In this lesson you were introduced to a few of the basic techniques required to assign and accurately position texture maps on polygonal models using UV texture coordinates:

- UV coordinates are essential for applying and accurately positioning texture maps on polygonal and subdivision surfaces.
- UVs can be explicitly created for a surface mesh using a variety of UV mapping techniques. (Planar mapping, spherical mapping, cylindrical mapping, and Automatic mapping)

8 | Polygon Texturing

Lesson 1 > Beyond the lesson

- UVs are represented as 2D coordinates and are viewed and edited with respect to the 2D texture map using the UV Texture Editor. The UV Texture Editor provides many other tools for editing UVs.
- UVs are usually positioned to fit within the 0 to 1 UV coordinate space unless the texture map requirements are such that the map needs to repeat across the surface mesh.
- It is useful to display both the 3D scene view and the 2D UV Texture Editor simultaneously when texture mapping so that a correlation between the 3D model and 2D UV coordinates can be made.
- You can visualize texture borders using Display > Custom Polygon Display.

You can open the PSD file you used in this lesson using Adobe® Photoshop® to learn how layers were used for the texture map. You can edit one or more of the layers to experiment with how the texture can be modified. After you modify and save the file in Photoshop®, remember to select Image > Update PSD Network in the UV Texture Editor so the texture map gets updated on the model in the Maya scene.

If you would like to learn how to render an image of the cracker box model see the *Rendering* chapter of this guide as well as the Maya Help to learn more about lighting, shading, and rendering.

This lesson used a simple polygonal model to introduce the fundamental concepts. When you work with more complex polygonal and subdivision surface models, you can also:

- layout overlapping UV shells that occur as a result of UV projection mapping to ensure they fit within the 0 to 1 texture space using Polygon UVs > Layout UVs
- maximize the use of texture space by forcing the UV borders to be mapped to the full area of the 0 to 1 UV texture range using Polygon UVs > Map UV Border
- align UVs to one another or snap them to the grid in the 2D view
- untangle a UV mesh that contains overlapping UVs using Polygon UVs > Relax UVs
- modify a group of selected UVs using UV Lattice and UV Smudge tools

8 | Polygon Texturing

Lesson 1 > Beyond the lesson

Many texture artists create good UV layouts for their models prior to creating the actual 2D images for their texture maps. This is done after the model is fully complete.

You can export a bitmap image of the 2D view of the UV Texture Editor to use as a guide for painting a texture in your favorite image creation software. In the UV Texture Editor, select *Polygons > UV Snapshot* to export the image.

If you use Adobe® Photoshop® for image creation and editing you can create a UV snapshot in a .PSD file format that creates the UV image on a separate layer. To create the .PSD format file while working in the UV Texture Editor, select *Image > Create PSD Network*.

If you want to learn more about a particular tool or feature that was used in this lesson, please refer to the Maya Help.

9 Rendering

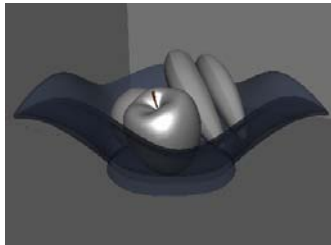
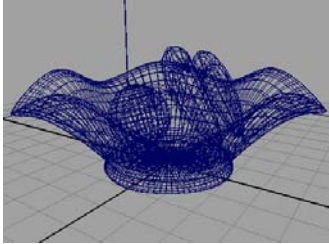

Image created by: Vivien May

In Maya, *rendering* refers to the process of creating bitmap images of your scene based on the various shading, lighting, and camera attributes that you set.

When rendering, Maya takes into account all of the various objects and scene attributes, and performs mathematical calculations to produce the final image or image sequence. Once you render a sequence of images, you can then play them back in sequence, producing an animation.

Rendering involves many components to produce a final image:

- Shading materials and textures
- Lighting and shadows
- Cameras and animation
- Rendering method
- Visual effects

9 | Rendering

> Preparing for the lessons

In Maya, rendering can be accomplished using software (Maya Software Renderer, mental ray® for Maya® Renderer, or the Maya® Vector Renderer) or hardware rendering methods. Each type has its distinct advantages. Which renderer you decide to use will be determined by your image requirements (that is, the look you require) and time constraints.

Software rendering generally allows you to create more precise results but can take longer to produce each frame or image. The Maya software render type uses a process for scene illumination that directly illuminates objects in the scene or simulates illumination by reflecting neighboring objects in the scene or via texture mapping the effect on the object.

The mental ray® for Maya® software render type additionally provides a feature called Global Illumination: a process that simulates the effect of indirectly illuminating objects that are not receiving direct illumination. It can also simulate light effects known as caustics. Hardware rendering is generally faster but is less capable of producing detailed results. In addition, some visual effects can only be produced via one method; at times, a combination of more than one type of rendering method may be required.

Rendering usually requires several iterations to achieve the final image that meets your requirements. The key is to strike the balance between producing the image that meets your requirements and producing it in the time required. This is particularly important if you are using Maya in a production setting.

This chapter introduces you to some of the fundamental concepts and skills related to rendering. This chapter includes the following lessons:

- “Lesson 1 Rendering a scene” on page 373
- “Lesson 2 Shading surfaces” on page 400
- “Lesson 3 Lights, shadows, and cameras” on page 421
- “Lesson 4 Global Illumination” on page 439
- “Lesson 5 Caustics” on page 458

Preparing for the lessons

To ensure the lessons work as described, select the Rendering menu set. Unless otherwise noted, the directions in this chapter for making menu selections assume you’ve already selected the Rendering menu set.

Lesson 1 Rendering a scene



This lesson provides a brief introduction to rendering in Maya. In this lesson, you learn how to:

- Assign shading materials to surfaces in the scene.
- Edit the color of shading materials.
- Apply simple textures to shading materials.
- Render both a single image and a sequence of images for an animation.
- Use Interactive Photorealistic Rendering (IPR) to perform test renders of the scene.
- Edit the Render Settings attributes to change the quality of the final results of an image.
- View a sequence of rendered frames for an animation.

9 | Rendering

Lesson 1 > Open the scene for the lesson

Open the scene for the lesson

In this lesson, you render a scene we've created for your use.

- 1** Make sure you've done the steps in "Preparing for the lessons" on page 372.
- 2** Open the scene named `Apple.mb`.

You can open the scene named `Apple.mb` from the *Maya Documentation, Lessons, and Extras* CD or from the drive where you copied the Getting Started with Maya data files.

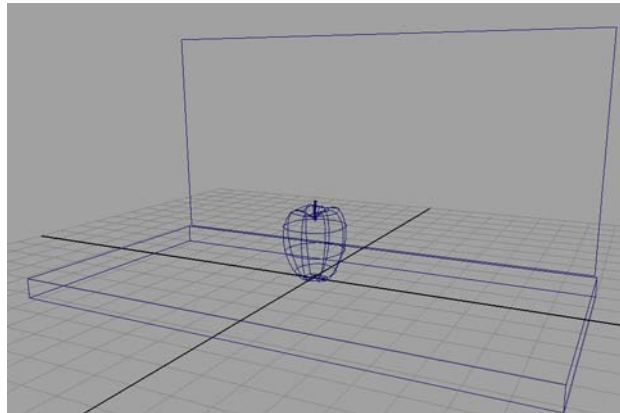

A scene is provided for you containing an apple sitting on a plane, with another plane as the background. A camera in the scene is animated to revolve around the apple at varying distances. (As an alternative to using the scene `Apple.mb`, you can create a similar scene with your own objects.)

- 3** Select **Window > Settings/Preferences > Preferences**.
- 4** Click the **Settings** category and make sure the **Time** option is set to **Film** (24 fps) so your animation will playback at the default rate of 24 frames per second.
- 5** Close the **Preferences** window.

You won't use the animated camera until later in the lesson. In the next steps, you color the apple and the planes by creating shading materials.

Creating shading materials for objects

A *shading material* is a collection of attributes that you apply to a surface to control how the surface appears when it is rendered. Shading materials include such attributes as color, shininess, and texture. The following table outlines the materials you'll be working with:

Material	Description
Lambert	Creates a matte surface without specular highlights. Lambert is the default shading material.
Blinn	Creates a shiny surface with specular highlights, often used to simulate metallic surfaces.

When you open the `Apple.mb` file, it initially displays the apple and the planes as wireframes (Shading > Wireframe). This is the default display mode for objects in a scene view.

To create materials for the apple stem

- 1 In the perspective view, select Shading > Smooth Shade All (hotkey: 5).

9 | Rendering

Lesson 1 > Creating shading materials for objects

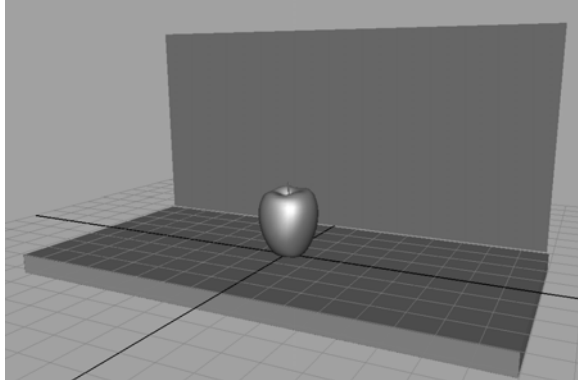

The apple and the other surfaces appear with a default gray, smooth shading material, lit using default lighting. Default lighting occurs when no other lights have been placed in the scene.

- 2 In the perspective view, select the apple stem by clicking its geometry. (Be sure that only the apple stem is selected.)

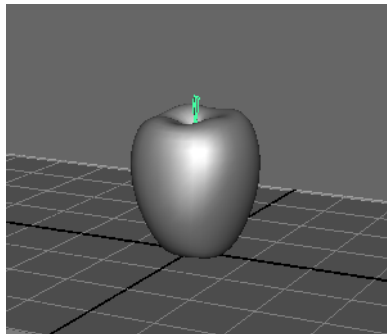

- 3 From the Rendering menu set, select Lighting/Shading > Assign New Material > Lambert.

The Attribute Editor appears for the Lambert material.

A Lambert material creates a matte surface without shiny highlights. You will learn more about materials and their attributes in a later lesson.

- 4 Click the gray box to the right of Color.



The Color Chooser window appears.

- 5 Click inside the color wheel and drag to a brown color.

The color you select in the Color Chooser is applied to the apple stem.

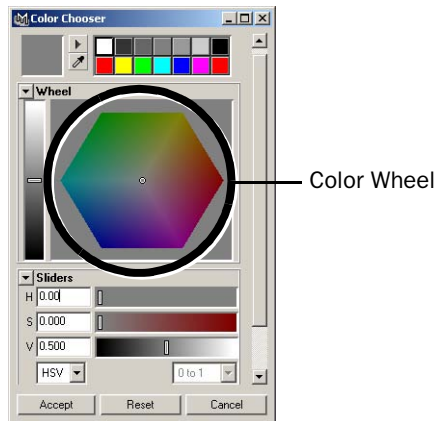

- 6 Click Accept to close the window.
- 7 In the Attribute Editor, rename the lambert shading material to *appleStem_lambert*.

To create materials for the apple

- 1 Right-click the apple and select Materials > Assign New Material > Blinn from the marking menu.
The Attribute Editor updates to display the attributes for the Blinn material.
A Blinn material gives the apple a shiny appearance.
- 2 Click the gray box to the right of Color.
The Color Chooser window appears.
- 3 Click inside the color wheel and drag to a red color.

9 | Rendering

Lesson 1 > Creating shading materials for objects

The apple's surface updates to the same color you select in the Color Chooser.

- 4 Click Accept to close the window.
- 5 In the Attribute Editor, rename the Blinn shading material to *appleSkin_blinn*.

To create materials for the counter and wall

- 1 Right-click the background plane and select Materials > Assign New Material > Lambert from the marking menu.
The Attribute Editor displays the attributes for the Lambert material.
- 2 Click the gray box to the right of Color.
- 3 In the Color Chooser window, click inside the color wheel and drag to a light blue color.
The color you select in the Color Chooser is applied to the plane.
- 4 Click Accept to close the window.
- 5 In the Attribute Editor, rename the Lambert shading material to *wall_lambert*.
- 6 Right-click the surface that the apple is resting on and select Materials > Assign New Material > Lambert.
The Attribute Editor displays the attributes for the Lambert material.
- 7 Click the gray box to the right of Color.
- 8 In the Color Chooser window, click inside the color wheel and drag to a beige color.
The color you select in the Color Chooser is applied to the plane.
- 9 Click Accept to close the window.
- 10 In the Attribute Editor, rename the Lambert shading material to *counter_lambert*.

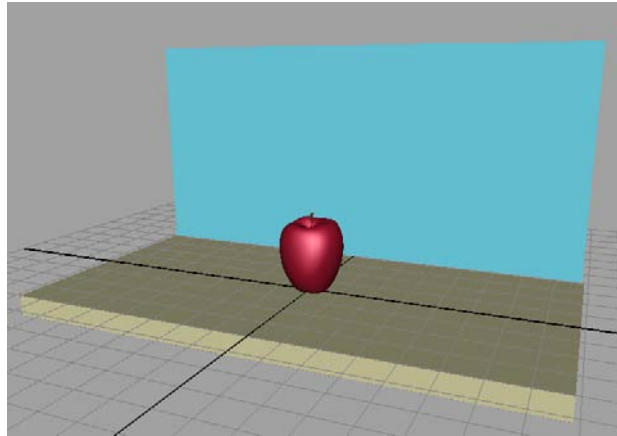

The counter, wall, and apple stem all have a matte Lambert surface, while the apple has a shiny Blinn surface. There are many other attributes you can set to change the appearance of these objects, which you'll explore in the next section.

Refining shading materials for objects

You can refine the shading materials in the scene to make the objects appear more realistic. In the next steps you connect (or apply) a *procedural texture* to the counter, and a *ramp texture* to the apple. These textures are connected to the color attribute of the shading material for each surface to provide natural surface variation. When you connect textures, you create *shading networks*. You'll learn more about shading networks in a later lesson.

A procedural texture is a 2D or 3D texture calculated based on an algorithm or mathematical formula. It can be useful for creating random patterning. A ramp texture is a 2D texture or color gradient in which the color or grayscale value changes across the image.

To connect a procedural texture to the counter surface

- 1** In the perspective view, right-click the counter surface and select Materials > Material Attributes.

9 | Rendering

Lesson 1 > Refining shading materials for objects

The Attribute Editor for the counter_lambert material appears.

- 2 To the right of the Color slider, click the Map button



The Create Render Node window appears and lists the various textures you can connect to the color attribute of the Lambert material assigned to the counter surface.

- 3 In the Create Render Node window, scroll through the list of textures, and from the list of 3D Textures, click Granite.

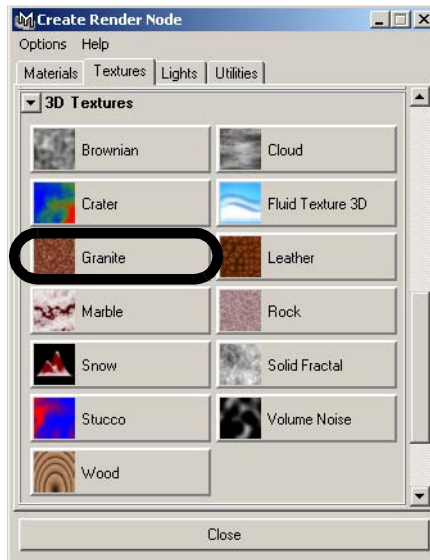

The procedural texture gives the counter the look of a stone granite counter top when it is rendered, and provides the context for the scene.

- 4 Press 6 to see a shaded and textured display of the granite texture on the counter top surface.

Lesson 1 > Refining shading materials for objects

- 5 In the Attribute Editor, under Granite Attributes change the Filler Color from the default reddish-brown to a beige color as follows:
 - Click the color box to the right of Filler Color.

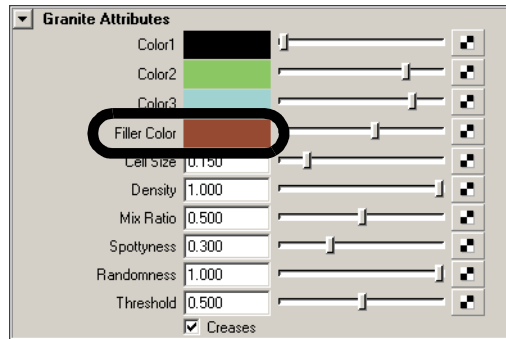

- In the Color Chooser window, select a beige color and click Accept.

Note Materials and textures displayed in the perspective view do not show their true appearance. To see the accurate appearance of the texture you must render the scene.

To connect a ramp texture to the apple surface

- 1 Right-click the apple and select Materials > Material Attributes from the marking menu.
The Attribute Editor updates to display the appleSkin_blinn material properties.
- 2 To the right of the Color slider, click the Map button.



The Create Render Node window appears and lists the various texture patterns you can connect to the Color attribute of the Blinn material assigned to the apple.

9 | Rendering

Lesson 1 > Refining shading materials for objects

- 3 From the list of 2D textures, click Ramp.



This texture creates a gradation through a series of selected colors. Applying the ramp texture provides the apple with a realistic variation in surface color.

- 4 In the Attribute Editor, under Ramp Attributes, change the Type to U Ramp.
The Ramp Type indicates the direction of the color gradient. A U ramp applies the gradient in a linear, vertical direction across the object.
- 5 Add another color component by clicking within the ramp.
A new set of color handles appears in the ramp, for a total of four color components.

9 | Rendering

Lesson 1 > Refining shading materials for objects

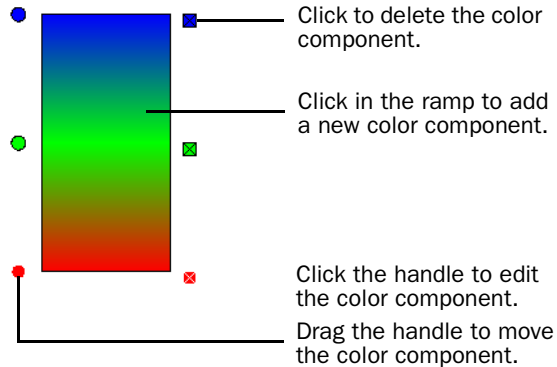

- 6 To change the ramp colors, click the top circular color handle (to indicate which color you want to modify), then click the color box to the right of Selected Color to display the Color Chooser window.

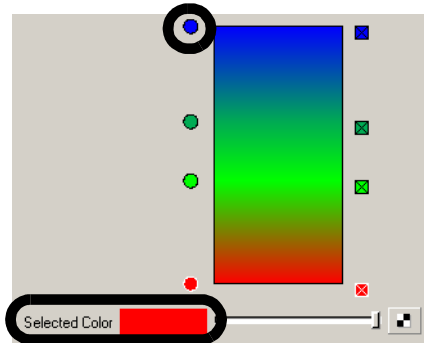

- 7 Click inside the color wheel and drag to a very dark brown for the first ramp color. Click Accept to close the window.
- 8 Repeat steps 6 and 7 for the other three ramp colors. For the two middle ramp colors, select a dark red. For the last ramp color, select a deep olive green.
- 9 Click Accept to close the window.
- 10 Use the circular color handles to reposition each component as shown below:

9 | Rendering

Lesson 1 > Maya renderers

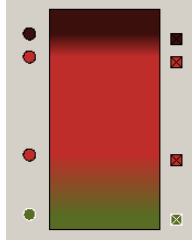

The position of these handles and the corresponding colors affect the location and breadth of the color within the gradient on the apple's surface.

11 Save your work.

In the next section you render your scene to view the textures and materials you've assigned to the objects.

Maya renderers

So far, you've seen the results of shading the apple and other surfaces in the scene view. In this view, Maya uses your computer's graphics hardware to display the shading and textures quickly but with low quality.

To view the shading results of the colors and textures in a more realistic fashion, you must use a renderer. In this lesson you use a process called *software rendering*.

Software rendering can take seconds or minutes to render a single frame of animation from your scene, depending on the complexity of surface geometry, shaders, lighting and other visual elements present in the scene.

The following table outlines the different types of renderers in Maya and what each is used for:

Renderer	Use
Maya's Software renderer	A general purpose renderer with broad capabilities. You can produce high-quality images with complex shading networks, including procedural textures and ramps. Software rendering is computed through your machine's processor.
Interactive Photorealistic Rendering (IPR)	A feature of Maya's software renderer, used to make interactive adjustments to the final rendered image. You can adjust shading and lighting attributes in real-time, and IPR automatically updates the rendered image to show the effects of your changes. IPR is useful for tweaking an image before rendering to disk.
mental ray® for Maya® renderer	A general purpose renderer that includes exclusive, advanced rendering functionality, such as host and network parallel rendering, area light sources for soft shadows, global illumination, and caustics (light patterns).
Maya Vector renderer	A specialized renderer used to produce stylized renderings (for example, cartoon, tonal art, line art, hidden line, wireframe) in various bitmap image formats (IFF, TIFF) or in 2D vector formats (SWF, AI, EPS, SVG). The Maya Vector renderer is often used to render web-ready images.
Maya's Hardware renderer	A general purpose renderer that uses your machine's graphics cards for computation. You can produce broadcast resolution images in less time than with software rendering, and in some cases, the quality may be good enough for final delivery.

9 | Rendering

Lesson 1 > Rendering a single frame using IPR

The Render View window

When you render your scene the rendered image appears in its own window called the *Render View*. By default, the Render View uses the same camera as the Scene View (persp), but includes particular rendering capabilities.

The following table shows the differences between the Render View and the Scene View:

	Scene View	Render View
Display	3D object scene	2D rendered image
Surfaces	modeled surfaces, the grid, vertices, curves, and object manipulators	shaded surfaces only
Background	default gray background	black background by default because only objects with materials that are lit can be seen
Quality	low-quality, colors and textures do not appear in their final display form	high-quality, colors and textures appear in their final rendered form

Rendering a single frame using IPR

In this section, you work with IPR (Interactive Photorealistic Rendering), a type of software rendering.

The advantage of rendering with IPR is that, after you render an image, you can adjust the shading and lighting attributes of the scene and then quickly update part or all of the rendered image to review the effect of your changes. IPR is useful for iterations when you need to fine-tune specific attributes. Updates to the image are not always instantaneous, but they are full quality.

To render the scene using IPR

- 1 In the perspective view, select View > Camera Attribute Editor to display the attributes for the camera.

You need to specify the exact region of the perspective view you want to render.

- 2 In the Attribute Editor, open the Display Options section and turn on Display Resolution.

A dark green rectangular border shows the region to be rendered. This region defines the area of the final image, and allows you to decide what appears or does not appear in the final image. (The left and right borders of the rectangle may be positioned at the edge of the window.)

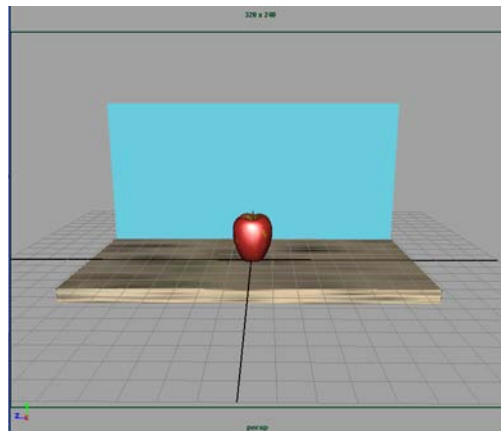

Dolly the view for a closer view

- 3 Select Render > IPR Render Current Frame (or select the IPR render current frame button on the Status Line). (By default, Maya uses the Software renderer as indicated on the Render View window's toolbar.)

The Render View appears and displays the rendered image.

9 | Rendering

Lesson 1 > Rendering a single frame using IPR

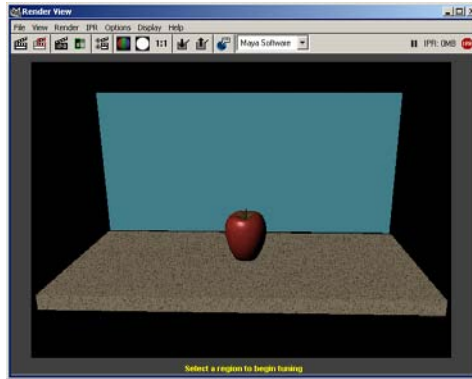

Rendered image of scene view

The rendered image shows the appearance of the apple based on the lighting, and shows the more realistic texture of the counter.

The message displayed at the bottom of the IPR Render View window states “Select a region to begin tuning”. In the next step, you create a subregion of the image to render using IPR.

- 4 In the Render View, select View > Frame Image to resize the Render View window so it fits closely to the rendered image.

To select a subregion to render using IPR

- 1 In the Render View, drag a selection box around the small area surrounding the apple, counter, and wall as shown:

9 | Rendering

Lesson 1 > Rendering a single frame using IPR

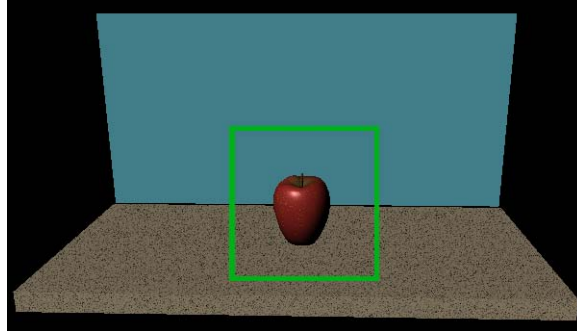

When using IPR, this selected region updates as you alter any shading, texture, or lighting attributes. Selecting a smaller region quickens the update. You can select regions throughout the image to see those areas update.

- 2** In the scene view, right-click the wall and select Materials > Material Attributes to display the Attribute Editor for the Lambert shader you applied to the wall.
- 3** Click the Color box and change the color to green.

The area within the selected region of the Render View updates immediately as you alter the color; the wall turns green.

When you drag within the color wheel of the Color Chooser window, the selected region updates occur immediately.

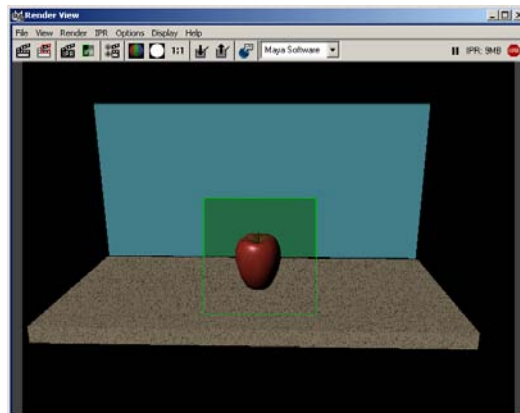

9 | Rendering

Lesson 1 > Rendering a single frame using IPR

Note If the region does not update, in the Render Settings window, turn the Raytracing option off.

(You won't alter any other attributes in this lesson. The purpose of the lesson is to learn the process of rendering, not to perfect the results at this point.)

4 From the Render View menu, select View > Reset Region Marquee. This resets the border of the tuning region to the full resolution of the image. If you update an attribute, the entire image will be updated.

5 From the Render View menu, select IPR > Redo Previous IPR Render. The rendered image updates to the full resolution.

By default, the resolution of the IPR window is 320 by 240 pixels. The advantage of this relatively small resolution is that it renders quickly. However, if you want a larger image, you can increase the image resolution.

To increase the size of the rendered image

1 In the Render View menu, select Options > Render Settings (or click the Render Settings button in the Render View window).

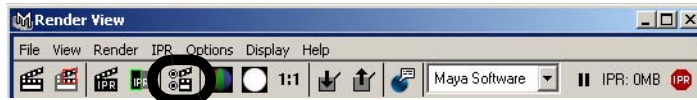

The Render Settings window appears.

2 Click the Common tab, open the Image Size section, and select 640x480 from the Presets drop-down list.

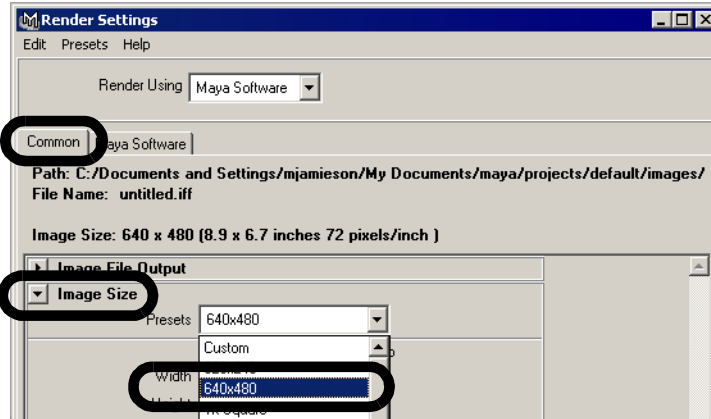

(An image size of 640 by 480 is four times as large as the 320 by 240 image size.)

- 3 Close the Render Settings window.
- 4 Close the Render View window.
- 5 Select Render > IPR Render Current Frame (or select the IPR render current frame button on the Status Line).

The Render View window opens and renders an image with an image size of 640 by 480 pixels.

Note If you are using Maya on Windows or Linux, rendering the scene displays another window called the Output window, typically behind other windows on your desktop. The Output window lists statistics about the image just rendered. For now, you can ignore and close the Output window. It contains information that you will appreciate more as you gain experience using Maya.

So far, you've used IPR to see changes you made to a shader. If you add lights to the scene rather than using default lighting, you can also use IPR to help adjust the lighting.

9 | Rendering

Lesson 1 > Rendering using the Maya software renderer

Rendering using the Maya software renderer

You are nearly ready to render the entire animation to disk. You must first switch camera views so you can render the scene from the point of view of the camera that was animated for this lesson. When animating a camera it's a good practice to create a second camera to animate, rather than animating the default persp camera. In that way you can return to the default perspective view should it become necessary.

Rendering the entire animation can take a lot of time, so it is useful to first use Maya's software renderer to test render a few frames to your monitor and examine the results.

Once you are satisfied with the quality of a few rendered frames, you can render the entire animation to disk.

To switch camera views and playback the animation

- 1** In the perspective view, select Panels > Perspective > apple_camera.
The view updates to display the scene as seen through the lens of the apple_camera.
- 2** Click the Play button in the Timeslider playback controls.
During playback, the animated camera tracks and tumbles about the apple.
- 3** Stop the animation at a frame you want to test render.

To test render the current frame of animation

- 1** In the Render View window, select Options > Render Settings.
- 2** In the Render Settings window, select Maya Software from the Render Using drop-down list.
- 3** In the Render Settings window, select the Maya Software tab.
- 4** In the Anti-aliasing Quality section, select Production Quality from the Quality drop-down list.

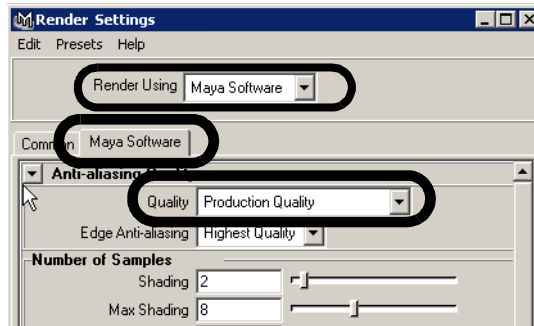

This setting provides high quality results by smoothing any jagged surface edges in the rendered image.

- 5 Close the Render Settings window.
- 6 In the Render View window, select Render > Render > Current (apple_camera).

This menu item uses the software renderer to render a single frame of the scene that you rendered with IPR previously but from the point of view of the animated apple_camera.

You might not see a big improvement in quality as compared to the IPR-rendered image. If you dolly the camera closer to the apple and render once with IPR and once with the software renderer, you will see an improvement at the edges of the apple as shown below:



IPR rendering
(no antialiasing)



Software rendering with
production quality antialiasing

9 | Rendering

Lesson 1 > Batch rendering a sequence of animation frames

- 7 Go to frame 120 of the animation, where the apple is viewed in a different position.
- 8 In the Render View, select Render > Render > Current (apple_camera).
Ensure that the rendered image looks good at this frame also.

Now that you've checked a pair of rendered frames that represent the entire animation, you are ready to render the entire animation sequence. In your own projects, you might want to test render several frames, particularly where new shading and lighting elements occur in the animation.

Batch rendering a sequence of animation frames

After you model, animate, and color your scene, you set several Render Settings options and then use the software renderer to *batch render* part or all of the animation's range of frames to files on disk. Each file represents a single frame (image) of the animation.

To set the Render Settings for batch rendering

- 1 In the Render View window, select Options > Render Settings to display the Render Settings window.
- 2 In the Render Settings window, select the Common tab, and then open the Image File Output section.
- 3 In the Image File Output section, set the following options:
 - **File Name Prefix:** Type the name `Apple`. This name will be the base of the filenames created by batch rendering.
 - **Frame/Animation Ext:** Select `name.#.ext`. This specifies that the filenames will have the format *prefix.frameNumber.fileFormat*. For example, batch rendering the entire 200-frame animation will create `Apple.0001.iff`, `Apple.0002.iff`, and so on through `Apple.00200.iff`.
 - **Image Format:** Select Maya IFF (.iff), Maya's standard image file format. You can use the `.iff` format for any further work you need to do, including previewing and compositing the animation. If you require a different format, you can specify it instead of `.iff` in the Render Settings.

Lesson 1 > Batch rendering a sequence of animation frames

- **Start Frame:** Enter 1, the first frame of the animation sequence to be batch rendered.
- **End Frame:** Enter 50, the last frame to be batch rendered. (Rendering all 200 frames may be time-consuming.)
- **Frame Padding:** Enter 4. This causes the *frameNumber* part of the filenames to be four digits prefixed with 0s. For example, the filenames will be `Apple.0001.iff` through `Apple.0050.iff`.
- **Camera:** Select `apple_camera` from the drop-down list to indicate which camera view to render.

The four-digit padded filename is compatible with many image playback programs, for example, Maya's FCheck utility. Image playback programs let you view rendered animation sequences on your monitor at real-time speed.

For the remaining options in the Render Settings window, you'll use the default settings. Maya will render using the camera (persp), image size (640x480), and anti-aliasing quality (Production Quality) that you specified earlier in the lesson.

After you set the Render Settings, the top portion of the Common tab shows the correct path and filenames for the files to be created during batch rendering. Check that this information is correct.

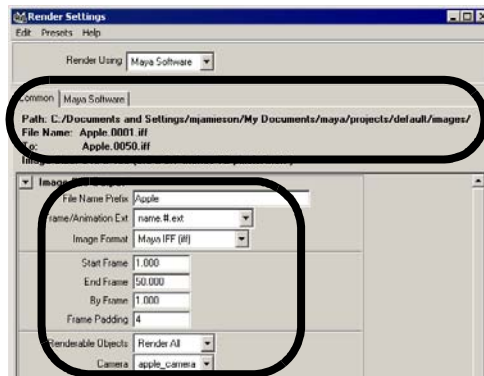

- 4 Close the Render Settings window.

9 | Rendering

Lesson 1 > Batch rendering a sequence of animation frames

To batch render animation frames

1 Save the scene.

It's a good practice to save the scene before batch rendering. This is useful if, after batch rendering, you need to change any display settings and render again. By saving the scene prior to batch rendering, you can examine the scene to learn which option settings were in effect at the time you batch rendered.

2 From the Rendering menu set, select Render > Batch Render > .

The Batch Render Frame window appears.

3 Turn on Use all Available Processors, then click Batch Render to start batch rendering.

(The Use all Available Processors option allows Maya to use all the processors available on the local machine to complete the render.)

Note For users of Maya Personal Learning Edition, the Use all Available Processors option is disabled. Use the default settings.

Batch rendering 50 frames of a simple scene takes a few minutes. A complex scene may take hours per frame, depending on the speed of your computer.

4 Close the Batch Render options window.

To check the status of the batch render

1 While Maya is rendering, select Window > General Editors > Script Editor. Expand the size of the Script Editor window. The window shows a completion log for the frames being rendered.

Maya puts the resulting files in a default *images* directory. The files have the following names:

```
Apple.0001.iff
```

```
Apple.0002.iff
```

```
Apple.0003.iff
```

...

...

Apple.0050.iff

The images directory is located in the same path as the scenes directory. You can have Maya save to a different path by changing the project setting. See the Maya Help for further information on projects.

- 2** Close the Script Editor when the following message appears:

```
// Result: Rendering Completed. See mayaRenderLog.txt  
for information. //
```

The `mayaRenderLog.txt` file contains rendering statistics for advanced users.

Viewing a sequence of rendered frames

You can use Maya's *FCheck* image viewing utility to view the batch-rendered images at a speed that approximates video or film.

To use FCheck to view a sequence of rendered frames

- 1** Select File > View Sequence.
The File Browser window appears.
- 2** Using the File Browser, navigate to the images directory for your current project (or wherever you saved the rendered sequence of images for the Apple).
- 3** Click the image file `Apple.001.iff` to select the first image in the sequence and then click Open.
The FCheck image viewing utility appears and the rendered sequence of 50 frames plays back as an animated loop.
- 4** Close the window after viewing the animation.

9 | Rendering

Lesson 1 > Beyond the lesson

Note The FCheck rendering utility has playback, display, and other options you can select from your keyboard. Details are available from the FCheck Help menu.

Beyond the lesson

In this lesson, you were introduced to some of the basic concepts for rendering an image. In this lesson you learned that:

- Surfaces are assigned shading materials to provide basic attributes such as color, shininess, reflectivity, and so on. Each shading material has unique characteristics that can be modified to suit your requirements.
- You can additionally assign a texture map to some of the shading material attributes so that your objects appear more realistic.
- Maya provides several methods for rendering an image. You can render using the Maya Software renderer, the Maya Hardware renderer, the Maya Vector renderer or the mental ray® for Maya® renderer. Each type of renderer has specific advantages and uses.
- You can choose the size and quality for a rendered image prior to rendering based on your specific needs and requirements.
- You can render a single image or a sequence of images from an animation.
- You can view one image, or a sequence of rendered frames using the FCheck utility.

As you render scenes, consider the following issues:

Using IPR

There are a few limitations to using IPR for fast visual feedback as you adjust shading and lighting. Besides being unable to provide production-quality anti-aliasing, IPR cannot display several other advanced display characteristics, for example, true surface reflections (raytracing) and 3D motion blur. If an advanced display characteristic seems to be missing from an IPR-rendered frame, try rendering the frame with the software renderer.

If you change the camera view, turn Depth Map Shadows on or off, or reposition shadows, IPR does not update the rendered image automatically. You must refresh the image. From the Render View window, select IPR > Refresh IPR Image.

Batch rendering

In this lesson, you used the Maya software renderer to check the image quality of two frames before you started to batch render. When you create scenes with sophisticated animation, it's useful to batch render with low-quality resolution to check the animation accuracy before batch rendering with production-quality resolution. For instance, you might preview your animation with the frames resulting from batch rendering at a small image size (320 by 240) with Preview Quality anti-aliasing.

You don't need to use the batch renderer to render single frames from your scene to disk. From the Render View window, select File > Save Image.

Hardware rendering

Hardware rendering leverages the power provided by hardware graphics cards to render your images. The benefits of hardware rendering include the ability to batch render frames more quickly than with software rendering, and rendering specific particle effects not possible through software rendering. In some cases, the image quality may be good enough for final use. You access the hardware renderer by selecting Render > Render using > Maya Hardware.

Hardware rendering has its own limitations when compared to software rendering. For more information on hardware rendering, see the Maya Help.

Rendering in layers

It's often useful to render objects in your scene in different layers and combine them using compositing software. In some cases, you must render some optical effects and then composite them afterwards. Rendering in layers can end up being faster than rendering an entire scene, and it lets you replace individual objects quickly if the need arises. To set up layers, use the Layer Editor, which appears below the Channel Box by default. For more information, see "Render layers" in the Maya Help.

9 | Rendering

Lesson 2 > Beyond the lesson

Lesson 2 Shading surfaces



Images courtesy The Art of Maya

In the real world, objects are seen in specific ways based on the following:

- The materials they are made of.
- Their surface textures.
- How they are lit and reflect light.
- The environment surrounding them.

In Maya, you provide your surfaces and objects with these characteristics by assigning shading materials to them.

Shading Materials provide instructions to the renderer so it can simulate how the surfaces in your scene react to light and appear in the final image. Shading involves such attributes as color, transparency, shininess, and many others to create a realistic look.

Getting Started with Maya

400

Editing the material attributes associated with shading materials affects how they appear in the rendered image. In this way, Maya provides the option of allowing you to create images as they would appear in the real world or in your imagination.

In this lesson, you learn to use basic shading features to render a sphere so it appears like an orange in the final image.

In this lesson you learn how to:

- Assign a shading material with specific color and surface attributes.
- Differentiate between shading material types (Lambert, Blinn, Phong, and so on) to achieve a specific material appearance.
- Assign a label texture map to a surface.
- Use the Hypershade editor to view and work with shading materials.
- Create a bump texture map to simulate the orange's pebbled skin.
- Control the placement of a 3D texture using a 3D manipulator.

Open the scene for the lesson

In this lesson, you work with a scene we created for your use.

- 1** Make sure you've done the steps in "Preparing for the lessons" on page 372.
- 2** Open the scene named `ShadeOrange.mb`.

You can open the scene named `ShadeOrange.mb` from the *Maya Documentation, Lessons, and Extras* CD or from the drive where you copied the Getting Started with Maya data files.

This scene contains a sphere modeled to resemble an orange.

9 | Rendering

Lesson 2 > Assigning a shading material

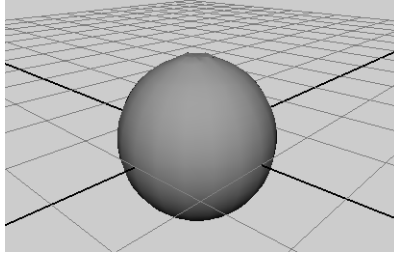

The scene's perspective view also has two settings turned on—Shading > Smooth Shade All and Shading > Hardware Texturing (Hotkey: 6)—which let you see the shading changes you are about to make.

Assigning a shading material

In the next steps, you create a material and assign it to the surface. A material is a collection of attributes that define color, shininess, and other surface characteristics.

To assign a material to an object

- 1 Before you create a new material, right-click the sphere and select Materials > Material Attributes.

The default material attributes appear in the Attribute Editor.

The default material assigned to the sphere (and all other surfaces) is a type of material called Lambert. The material displays the surface with gray shading. You should not edit the default shading material.

- 2 Right-click the sphere and select Materials > Assign New Material > Blinn to create a new material for the sphere.

The new material's attributes appear in the Attribute Editor.

A Blinn material gives a surface a shinier look than a Lambert material. Blinn is a good choice for creating a variety of surface appearances. Knowing which material type to use for a particular surface comes with practice. Fortunately, you can change the material type later on, so you do not need to make a decision now. You will learn more about material types later in the lesson.

- 3** In the Attribute Editor, click the gray box to the right of Color to open the Color Chooser.



- 4** In the Color Chooser, click inside the color wheel (hexagon) and drag the pointer to an orange-colored area, as illustrated.

The sphere becomes the same color you select in the Color Chooser. Also drag up the slider to the left of the hexagon to get a brighter shade.

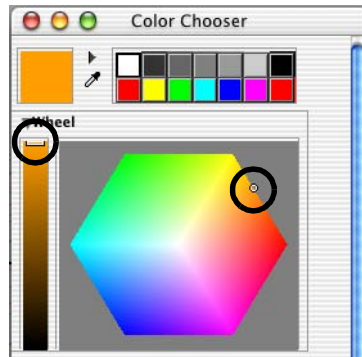

- 5** Click Accept to close the Color Chooser.

If you compare the color in the Color attribute box with the sphere's color in the scene view, you'll notice a difference.

The color you assigned is only one aspect of surface appearance. The appearance also depends on how the surface reacts with light. The main attributes that control the reaction to light are under the Common Material Attributes heading. As an example of these attributes, you will change the Diffuse setting.

- 6** In the Attribute Editor, drag the Diffuse slider to its right to increase the color brightness as viewed in the scene view.

This will help create the illusion of a bright orange.

9 | Rendering

Lesson 2 > Modifying surface specularity

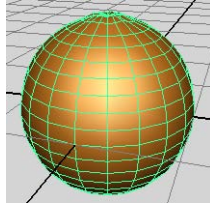

Diffuse = .8

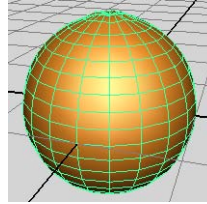

Diffuse = .95

In practical usage, the Diffuse setting makes a surface appear brighter. The name diffuse comes from a property in physics that describes how light spreads after it strikes a surface. A surface with a high diffuse property spreads the light that strikes it, making the object appear brighter.

Like the Diffuse attribute, the other Common Material Attributes also refer to general characteristics of light and the way a surface reacts to light.

The next section in the Attribute Editor, Specular Shading, contains attributes that control the appearance of shiny highlights on the surface.

Next, you'll alter the surface specularity—the amount of light that reflects off a surface, resulting in shiny highlights.

Modifying surface specularity

When light reflects in a concentrated manner off of a surface, a specular highlight results. Specular highlights can be thought of as “pseudo” reflections of bright areas in the scene (sunlight, bright lights, and so on). Modifying the specular attributes affects the perceived reflectivity for a surface. When you reduce the specularity, you in turn reduce the perceived reflectivity.

To modify the specularity of a material

- 1 In the Specular Shading section of the Attribute Editor, move the Eccentricity slider back and forth to change the size of the shiny highlights.
- 2 Move the Specular Roll Off slider to change the blend between highlighted and other areas of the surface.

Changes to this attribute do not alter the surface in the scene view, so you need to check the Material Sample in the Attribute Editor (see the following illustration). You can also render a test image (Render > IPR Render Current Frame).

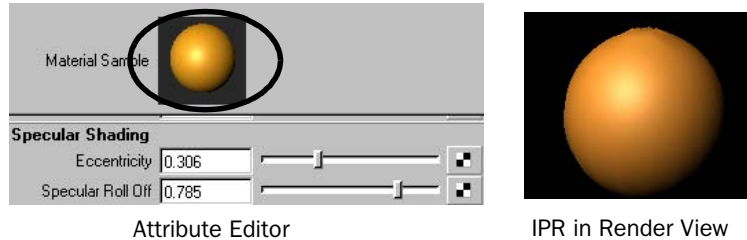

As you work with shading, you'll find many attributes that have no effect in the scene view, for instance, Ambient Color and Translucence. Generally, the scene view is a rough approximation of how the scene will render.

The IPR renderer is ideal for testing shading. It shows the results of all changes you make to shading and shows them immediately. There is only one attribute change the IPR renderer does not show—reflectivity. See the next step for details.

Some attribute changes such as reflectivity and reflections are not displayed by the Material Sample.

Material types

A material type (also referred to as a shading model) defines how a particular shading material on a surface simulates a natural reaction to light. Blinn, Phong, and Lambert are a few examples of material types available in Maya. Each of these material types provide distinct shading characteristics based on the mathematical algorithms that define them.

From the settings you've made so far, you may decide you want to give the orange a different look than possible with the Blinn material. You will now change to a different material for comparison.

9 | Rendering

Lesson 2 > Assigning textures

To set the material type

- 1 Next to the Type attribute near the top of the Attribute Editor, pull down the menu and select Phong E.

Phong and Phong E are variations of the Lambert material type, with specular highlights added. The main difference between materials is the way each handles specularly. By switching between the material types, you can compare which material gives you the specularly you need.

Your settings for the Color and Diffuse attributes are maintained because they are common to all material types. The Specular Shading and all other attribute settings do not convert when you change the material, so it's best to choose your material before you make many changes.

- 2 In the Specular Shading section, you can leave Roughness and Highlight Size at the default settings. The default highlight settings give the orange a waxy look.

These attributes are similar to the Blinn attributes, Eccentricity and Specular Roll Off. Unlike the Blinn counterparts, these highlights do not appear in the scene view. You can see the highlights only in a rendered image and in the Material Sample.

- 3 The Phong E material type has a Whiteness attribute not available with Blinn. Change Whiteness to a light gray to accentuate the highlights.

This change is subtle, so drag the slider back and forth while watching the effect in the Material Sample or in an IPR region. Look for the entire highlighted area to become whiter. Again, a strong highlight will create a waxy look.

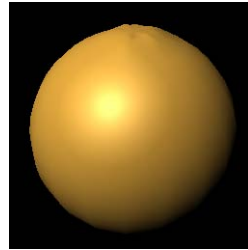

Rendered image

Assigning textures

For an orange, one color may be all that you need. In this section, you will go a step further by making a logo stamp appear on the orange skin. For this and other color effects, you need to apply a *texture* to your material.

In visual arts, a texture is any kind of surface detail, both visual and tactile. In Maya, a texture is a collection of attributes that creates surface detail. Textures have a more specialized display purpose than materials. For example, you can use textures to create the appearance of a marbled pattern, bumps, or a logo image on the side of a can.

In the Maya Help, a texture is also referred to as a texture node. A *node* is a collection of attributes (or actions) with a common purpose. A shader is sometimes called a shader node or material node.

To display a texture on a surface, you apply a texture node to an attribute of the surface material. In the next steps, you apply a texture to the Color attribute of the Phong E material.

To apply a texture to a material

- 1 Click the Map button next to the Color slider. This is a quick way of applying a texture to an attribute. This is also called *mapping* a texture.



The *Create Render Node* window displays a list of the textures you can apply. The texture names and their icons help you to decide which texture is appropriate for the effect you want.

9 | Rendering

Lesson 2 > Assigning textures

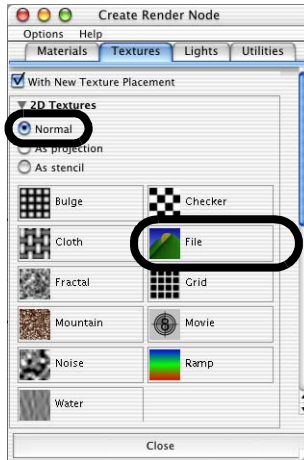

To create the logo stamp effect, you will use the File texture. A File texture uses an image file that you or someone else created separately, such as a drawing from a paint program. For this lesson, you'll use an image we created for you.

- 2 Before you create the texture, make sure Normal is selected in the options above the texture swatches.

The Normal option means Maya will stretch the texture evenly around the surface. The other settings—Projection and Stencil—are other ways you can apply a texture. You will learn about these settings at the end of the lesson.

- 3 In the 2D Textures list, click the File button once.

At this point the system will prompt you with the warning that “The IPR file does not have enough information to support your most recent change”. Select “Close the IPR file and stop tuning”. The file1 node appears in the Attribute Editor.

The file texture also causes the sphere to turn white in the scene view and black in a rendered view. This is a temporary color until you specify the actual file name of the file texture.

- 4 Click the folder icon to the right of the Image Name attribute. A browser window opens with the path set to a default directory called *sourceimages*.

Maya looks for source images in a default sourceimages directory. However, Maya can use file texture images anywhere on your workstation or local network. For example, you could have them on a central disk drive that is shared among your coworkers.

- 5** Navigate to the Rendering directory and open mayakist.iff. (This is the same directory where you obtained the ShadeOrange scene file.)

- 6** In the Render View window select IPR > Redo Previous IPR Render.

The file texture with a Mayakist logo now appears on the sphere. The logo is somewhat jagged, which will simulate the look of an ink stamp on rough orange skin.

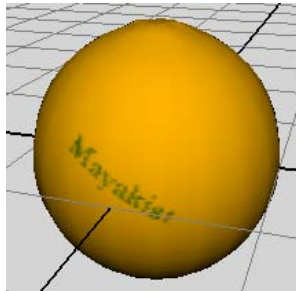

- 7** In the Attribute Editor, click the place2dTexture1 tab.



The place2dTexture1 tab is a node with attributes that control the texture's position on the surface.

If you select another object and the Attribute Editor no longer displays the file texture attributes, it's easy to restore the display. Right-click the sphere, select Materials > Material Attributes, and click the texture map icon next to the Color attribute.

- 8** As an example of the place2dTexture1 placement controls, move the Rotate UV slider slightly to the right, to a value about 5.9. This rotates the Mayakist logo on the surface.

9 | Rendering

Lesson 2 > Using the Hypershade editor

In this case, the texture placement needs almost no adjustment. For the ease of this lesson, we created a file texture that conforms to the sphere's shape by default. In practice, placing file textures requires more adjustment. For details, see "Beyond the lesson" on page 419.

Using the Hypershade editor

After you create a texture node, you will often want to return to the associated material node to make changes. Because material and texture nodes do not have icons that represent them in your scene view, you need a special editor, called Hypershade, to select them and edit their attributes. In this section, you learn how to work with Hypershade.

To view and edit material attributes using Hypershade

- 1** In the perspective view, select Panels > Saved Layouts > Hypershade/Persp. This layout is convenient because it's common practice to drag and drop items from Hypershade (using the middle mouse button) onto objects in the perspective view. You can also open Hypershade as a separate window (Window > Rendering Editors > Hypershade).
- 2** At the top of Hypershade, click the Materials tab to make sure the tab is displayed. If the material swatches are too small to see clearly, dolly into the view using the same keyboard and mouse shortcuts you would use in the scene view.



This tab shows all the materials currently in your scene. It is especially useful when you have a complex scene and you need to locate a material to edit. The materials you will recognize are the default Lambert material and the Phong E material. You can ignore the others. They exist in all scenes, by default, for use with other Maya features.

In addition to the Materials tab, Hypershade includes other tabs to help you keep track of textures, lights, and other nodes related to rendering.

- 3 With the middle mouse button, drag the lambert1 swatch into the scene view and over the sphere. When you release the mouse, the Lambert material appears on the sphere instead of the Phong E material you previously created.

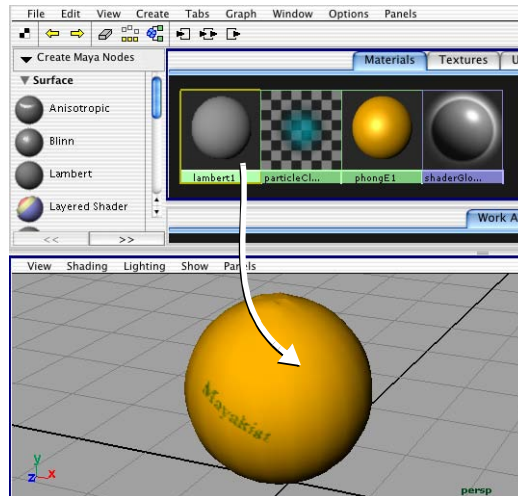

- 4 Drag the phongE1 swatch onto the sphere to reapply that material. Hypershade is designed for quick, drag-and-drop operations such as this.
- 5 Select the sphere.
- 6 From the menus in Hypershade, select Graph > Graph Materials on Selected Objects.
A graph appears in the Work Area tab in the bottom section.

9 | Rendering

Lesson 2 > Using the Hypershade editor

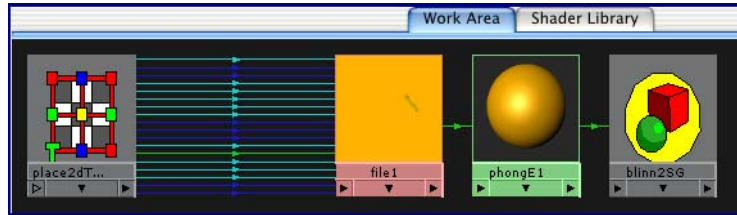

This graph shows all material and texture nodes applied to this object. While the Materials tab shows a catalog of the materials in the scene, the Work Area tab shows whatever material, texture, or other node you are currently working on. The Graph menu has several menu items that change the contents of the Work Area display.

The Shader Library tab shown in the above illustration might not be a part of your Maya installation. It is an optional feature, discussed at the end of this lesson.

The Work Area shows connection lines between the nodes. The lines have arrows that all point in one direction. For a closer look at these arrows, dolly into the view using the same keyboard and mouse shortcuts you would use in the scene view.

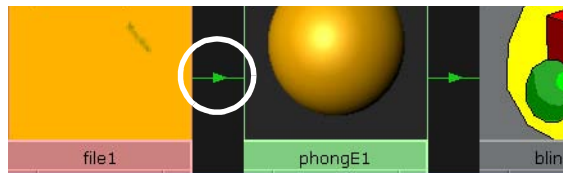

The arrows depict Maya's internal information input and output, called a stream. The next step shows the importance of this connection stream.

- 7 Click the line between the file1 and phongE1 nodes (it turns yellow) and press the Delete key.

The sphere reverts to the default gray color because you have broken the connection between these nodes and the texture is no longer assigned to it. This is a simple illustration of how the connection stream works. The file1 texture node is upstream from the connection you deleted, so it no longer inputs data into the material; Maya ignores it.

In practical terms, this is an example of how you can disconnect a texture from a material without actually deleting the texture. For example, you may want to remove the file texture from this material and connect it to another material instead. In a later step, you will learn about using Hypershade to make connections between textures and materials.

- 8 Select Edit > Undo to restore the file texture connection you deleted.
- 9 In Hypershade, right-click the center of the phongE1 swatch and select Rename.
- 10 Type: *Orange*.

Renaming is not as important in this scene as it would be in more complex scenes with several materials.

The Rename operation is one of several useful menu items that appear when you right-click a material swatch. Another handy menu item is Assign Material to Selection. You can use this operation to assign a material to multiple selected objects rather than assign it one object at a time.

Creating a texture within the Hypershade editor

To mimic the skin of an orange, you will add a *bump map* texture. A bump map creates the illusion that the surface has bumps or other types of surface relief. You will map the texture using the Create Bar in Hypershade.

The Create Bar is similar to the Create Render Node window you have used already. It is built into Hypershade for greater convenience.

Create Maya Nodes appears at the top, by default. Next to the heading is an arrow icon. If you click this icon, you switch to the Create mental ray Nodes mode. In this case, leave the Create Maya Nodes selection turned on.

The Mayakist logo file texture is a 2D texture, which wraps evenly around the surface. Next, you create a 3D texture. A 3D texture is for making objects appear to have been carved out of a solid substance, such as marble or wood.



9 | Rendering

Lesson 2 > Creating a texture within the Hypershade editor

To create a bump texture within the Hypershade Editor

- 1 In the Create bar, scroll down to the 3D Textures heading.
For this bump effect, you use a Brownian 3D texture. Experience has shown that a Brownian texture is the best texture for approximating the bumps on an orange skin. Becoming skillful with textures is a matter of observation, experimentation, and experience.
- 2 With the middle mouse button, drag the Brownian texture (under 3D Textures) onto the Orange material swatch in the Work Area tab and release the mouse button.
- 3 From the menu that appears, choose bump map.
Maya connects or applies Brownian to the Orange material's bump map attribute.

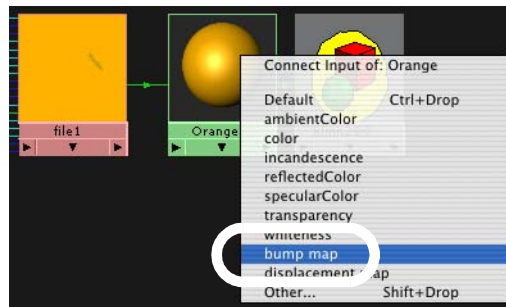

The pop-up menu shows a list of common material attributes. Although you can map textures to any material attribute, these are the most commonly mapped attributes.

By default, you can assign only one texture per attribute. Attributes that already have an assigned texture appear in italics. (For a discussion about assigning multiple textures to an attribute, see "Layered textures" on page 420.)

This drag-and-drop method of applying a texture is essentially the same as clicking the map icon next to a material's attribute slider. Using Hypershade offers a faster, more graphical alternative to using the Attribute Editor.

- 4 Select Graph > Input and Output Connections to view the node connections for the new texture you created.

Lesson 2 > Creating a texture within the Hypershade editor

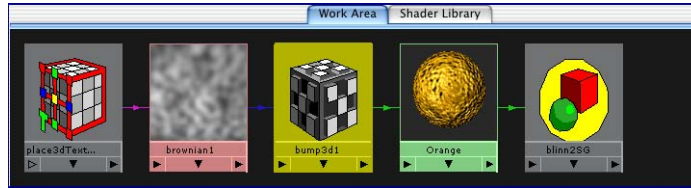

Also notice that bumps from the bump map appear in the Orange material's swatch. The Orange material swatch is the same as the Material Sample that appears in the Attribute Editor for the material node. (The bumps also appear in a rendered image, but not in the scene view.)

- 5 Double-click the bump3d1 swatch (the checkered cube) to display its attributes in the Attribute Editor.

This node is the link between the texture and the material. It converts visual information, such as the mottled Brownian pattern, into the appearance of surface relief.

The most important attribute in the bump3d1 node is Bump Depth, which controls the intensity of the bumps.

- 6 Change Bump Depth to 0.150. In the Orange swatch or a rendered image, you'll see that this diminishes the bumps as compared to the default value 1.0.

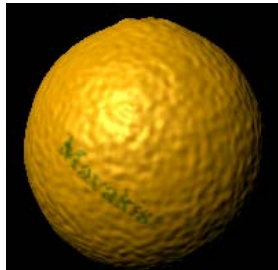

9 | Rendering

Lesson 2 > Modifying a bump texture

Note If you select Render > IPR Render Current Frame while Hypershade is selected, a message appears: *Please select the view you want to render.* Either select the perspective view before choosing IPR Render Current Frame, or, in the Render View window, select IPR > Redo Previous IPR Renderer.

7 In the Hypershade panel, click the brownian1 texture swatch to reveal its attributes. Set the following:

- Increment: 0.3
- Octaves: 4.0

These values produce a rendered image closer to real orange skin.

Our recommendation for these values is based on experimentation. For Brownian and some other textures, it's usually faster to get desirable results by experimenting with the settings rather than trying to understand the definition of each attribute.

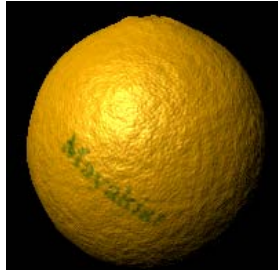

Modifying a bump texture

The bump texture is too crater-like to be a convincing orange. The bumps are too numerous and too deep. A quick way to fix this problem is to scale up the entire texture.

To interactively position a 3D texture

- 1** Click the place3dTexture1 swatch, to the left of the Brownian color swatch.

This node controls the 3D texture's position, scale, and rotation. The visual display of this node is a large cube that surrounds the sphere in the scene view. This is the texture placement cube.

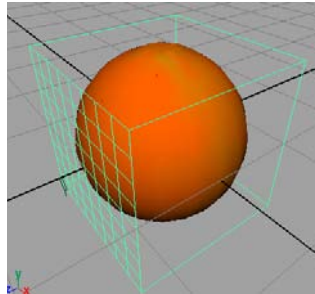

- 2 Click the Interactive Placement button in the Attribute Editor. A manipulator appears for the texture placement cube.
- 3 In the scene view, click on the center scale box to activate the center scale option. Scale the whole texture placement cube to about twice the original size (until the Scale attribute values are about 2).

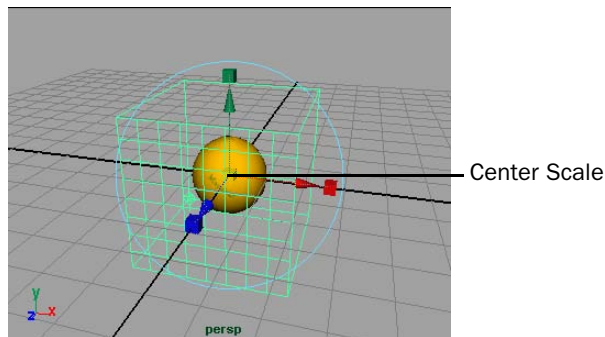

Now when you render, the bumps on the surface appear wider and smoother, like the bumps on an orange skin. For example, the bumps in the area surrounding the highlight do not appear to be as deep as they were before you scaled the texture.

9 | Rendering

Lesson 2 > Modifying a bump texture

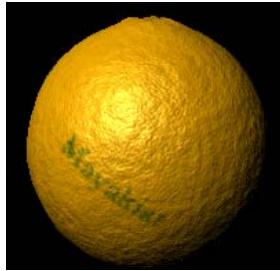

Before scaling

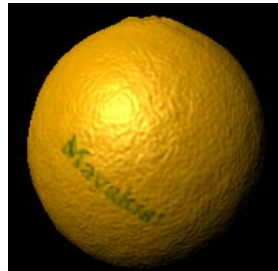

After scaling

Scaling a texture placement cube is a common way to tune the texture's display. Scaling does not actually change the pattern, but enlarges or shrinks it relative to the surface.

- 4 Now that you've changed the surface texture through scaling, move the texture placement cube above the sphere (drag the green arrow up), to see how that affects the texture.

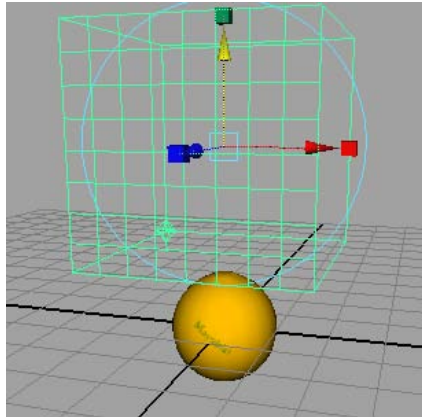

In the rendered image, notice that the bumps still remain on the sphere. Objects do not need to be within the texture placement cube, because it represents an imaginary texture volume, which is infinite.

However, movement of the texture placement cube does shift the surface texture pattern. The difference is hard to notice on a uniform texture like Brownian. Transforming the cube would be more noticeable with a texture such as Marble, where the veins within the pattern would be repositioned.

Movement of the object itself also shifts the surface texture. For example, if you were to animate the orange rolling and then render an image sequence, the texture would shift each frame rather than roll with the surface. To prevent this undesirable effect, you need to make sure that the texture moves in the same way the object moves. One way to do this is to parent the texture placement cube (also called the place3dTexture node) to the object. For more information on parenting, refer to the Maya Help.

Beyond the lesson

In this lesson, you were introduced to some of the features available for shading surfaces. You learned that:

- Shading materials can employ a variety of material types that can be used to achieve specific surface characteristics (Shininess, Matte, and so on).
- Textures can be applied to a shading material to enhance the realism of the final image. For example, logo graphics, bumps, and so on, can be added to enhance the detail on the surface.
- Textures can be 2D or 3D in nature. Each has its unique techniques for application and placement.

Placement of textures

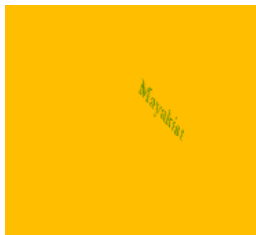

9 | Rendering

Lesson 2 > Beyond the lesson

When you put the Mayakist logo on the surface, the letters appeared straight. The letters are actually skewed in the texture. We skewed the logo for your use in this lesson so that it looks straight when stretched onto the surface.

In your own work, skewing texture images is usually too difficult and impractical. A more practical Maya technique for assigning and positioning file textures is to use texture projection. With this feature, you project the texture onto the surface as if you are projecting a slide image onto a screen. The texture is positioned where the projection strikes the surface. Instead of a skewed Mayakist logo, you could use a straight logo and project it onto the sphere. You could tune the angle of projection so that the curvature of the surface skews the logo just as in the lesson. To assign textures as projections, you turn on the As Projection option at the top of the 2D Textures section of the Create Render Node window.

The placement of texture projections is similar to the placement you performed for the bump map (3D) texture. Like the bump map texture, you need to parent the texture map projection (the place3dTexture node) to the object in order to avoid the texture placement changing when the object moves.

Layered textures

Suppose you want to add a scarred pattern to the orange skin. Because you can only have one texture assigned to the Color attribute you can use a Layered Texture to combine two or more texture maps.

The Layered Texture is a texture node that lets you composite or layer several textures on top of each other. You assign it to a material's attribute just like other textures. Within the Layered Texture's attribute controls, you can connect other textures and control how they blend together. For example, the bottom layer could be the logo image you used in the lesson, and a top layer could be an image of streaking lines that resemble scars. The combined logo and scars would give the orange the final aged look that you wanted.

Shader Library

As an option, you can install a Shader Library with Maya to help you quickly create common materials, such as bricks, fabrics, foods, and many other surface types. When installed, a Shader Library tab appears in Hypershade. To use a material, find the type of shading you want, drag and drop it into Hypershade, then drag and drop it onto a surface in your scene using the middle mouse button.

Lesson 3 Lights, shadows, and cameras



Image courtesy The Art of Maya

Directors of live-action film use camera and lighting techniques to enhance the visual impact of a scene. Wide, medium, and close up views of the subject, depth of field, high or low key lighting all communicate something about the subject and the scene to the viewer.

Lighting and camera techniques are one of the most crucial aspects to consider when working with artificial characters and objects. The more realistic the lighting and shading appear, the more convincing the scene will appear to the viewer.

A prerequisite to creating effective 3D rendered animation is to study the lighting and camera effects used in live-action film. Your goal is to create the desired scene ambience while keeping the lights and camera view as unobtrusive as possible.

In Maya, it is possible to simulate both realistic and unrealistic lighting and shadow effects for your final images and animations. In this lesson, you learn basic techniques for working with lights, shadows, and cameras. In this lesson, you learn how to:

9 | Rendering

Lesson 3 > Open the scene for the lesson

- Create and position various types of lights in the scene.
- Edit the attributes of lights and experiment with their effect in the scene.
- Cast shadows on your surfaces using the lights and objects in the scene.
- Create and animate an additional camera in the scene.

Open the scene for the lesson

In this lesson, you work with a scene we created for your use. In the first steps, you open the scene, create a directional light, and compare the directional light's effect to the scene's default lighting.

- 1 Make sure you've done the steps in "Preparing for the lessons" on page 372.
- 2 Open the scene named `Lights.mb`.

You can open the scene named `Lights.mb` from the *Maya Documentation, Lessons, and Extras* CD or from the drive where you copied the Getting Started with Maya files.

The scene contains a room with two walls and a floor. Sitting in the room is a drafting table and lamp, grouped under the name `tableGroup`. All objects have a default gray shading.

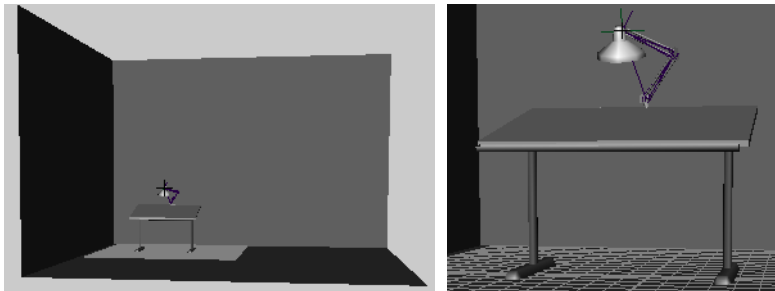

When you open the scene, Maya lights the scene with default lighting provided by an imaginary light fixture. It emanates light infinitely from a point above and behind the active scene view camera. There is no icon that represents the default light in the scene view.

Directional lights

Maya has many types of lights that simulate natural and artificial lighting. In the next steps, you create a light for the scene using a *directional light*. A directional light uses parallel rays of light, as if illuminating from a very far distance, to illuminate the scene. A directional light is often used to simulate sunlight.

To create a directional light

- 1 Select Create > Lights > Directional Light.

A directional light is created at the center of the scene.

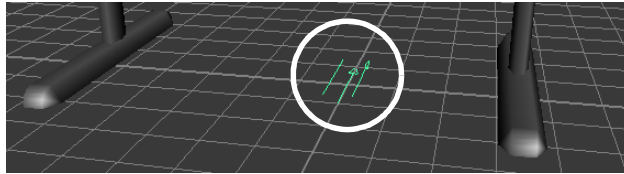

Because a directional light is similar to sunlight. Its parallel rays strike all objects in the scene from a single direction as indicated by the arrow icon representing the light. The position of the light is not so much important as the direction that the arrow icon points.

When you create a light, the scene view does not display its effect, by default. The scene view instead uses default lighting.

- 2 Select Lighting > Use All Lights (Hotkey: 7). This lights up the scene view only with lights you've created, not with default lighting. If you later want to see the scene view with default lighting again, select Lighting > Use Default Lighting (Hotkey: 6).

When you render the scene, by default, Maya uses all lights you've created. If you don't create any lights, Maya creates a temporary default directional light for you and then deletes it when the render is complete.

Next, you aim the directional light and edit its attributes.

9 | Rendering

Lesson 3 > Directional lights

To edit the directional light

1 With the directional light selected, rotate the light in various directions. The shading of surfaces changes as you rotate the light. The more directly the light points at a surface, the brighter the shading. A directional light is affected by its rotation, not its position. As you'll see later, the position of other lights affects the lighting.

2 Rotate the light as follows:

- Rotate X: -40
- Rotate Y: 25
- Rotate Z: -20

With this orientation, all object surfaces in the scene show the effect of the light in the current camera view.

3 With the light still selected, open the Attribute Editor (under the Window menu). Drag the Intensity slider to various values to see the effects of intensity.

Higher values brighten the surfaces. For example, an Intensity of 1.6 brightens the lighting so much that the gray default shading of some surfaces are bleached to white.

Note Several of the following illustrations in this lesson are snapshots of the scene after rendering. To render the scene, select **Render > Render current frame**. Do not use IPR rendering for this lesson because it doesn't automatically update the image for some of the changes you make to the scene.



- 4** In the Attribute Editor, click the white Color box above the Intensity box. This displays the Color Chooser.
- 5** Click inside the color wheel (hexagon) and drag the pointer to a red color. The lighting imparts a red hue to the surfaces in the scene.
- 6** Change the color back to white and set the Intensity to 1.2 or so. You'll use these settings for the basic lighting of the scene.

Spotlights

In the next steps, you light part of the desk by creating a spotlight and positioning it within the desk lamp. A *spotlight* emits light from a single point within a limited cone angle. You can aim a spot light in the direction you want the light to illuminate.

To create a spotlight

- 1** Select Create > Lights > Spot Light.
This creates the spotlight's icon at the center of the grid. The light points toward the back wall.
- 2** Move the spotlight above the lamp. (Drag the light up along its local Y-axis.)

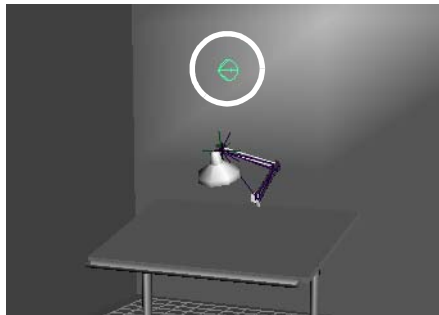

If you look at the spotlight icon from several angles, you'll notice that it is shaped like a cone with an arrow pointing out of it.

The cone symbolizes that a spotlight emits a beam of light that gradually widens with distance.

9 | Rendering

Lesson 3 > Spotlights

- 3 Select Modify > Transformation Tools > Show Manipulator Tool.

With the spotlight selected, this tool provides two manipulators that you can move to position and aim the light precisely.

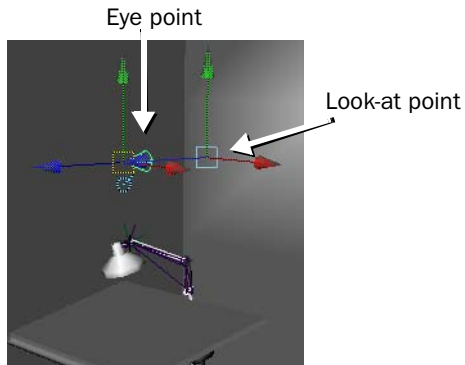

The look-at point specifies where the light focuses. The eye point defines the position of the light source. All types of lights have an eye point, but not necessarily a look-at point.

- 4 Move the look-at point to the top of the table, and move the eye point roughly to the center of the lamp housing.

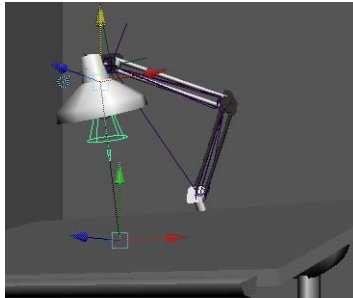

You can also use the Rotate tool to center the eye-point more accurately in the lamp housing.

An alternative way to position a spotlight is to select the light and then select Panels > Look Through Selected. You can then dolly and pan the view to focus on the desired surface. The area of focus is where the light strikes the surface. To return to the perspective view select Panels > Perspective > persp.

- 5** If you render the scene, you'll notice that the spotlight lights up a circular region on both the desk and the floor.

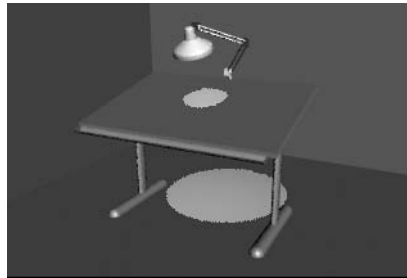

By default, light passes through and lights up each surface in its path. The circular region of light is wider on the floor than the desk because a spotlight emits a beam of light that widens with distance.

Only the floor, not the desk, will be lit by the spotlight in the scene view. You'll see the desk lit up only if you render the scene.

- 6** You can prevent the light from passing through the table. With the light selected, display the Attribute Editor. Open its Shadows section and then the Depth Map Shadow Attributes section, then turn on Use Depth Map Shadows. Rendering creates this result:



9 | Rendering

Lesson 3 > Editing light attributes

By turning on Use Depth Map Shadows, the spotlight's lighting is blocked by the first surface it hits (the desk). The floor is in the shadow of the desk so it receives no light. You'll learn more about Depth Map Shadows later in the lesson.

If you were to render the scene with IPR rather than the software renderer, the image would not automatically remove the lighting of the spotlighting from the floor when you turn on Use Depth Map Shadows. You would need to refresh the image again in the Render View window by selecting IPR > Refresh IPR Image.)

Editing light attributes

Spot lights, directional lights, and other light types have several unique attributes (for example, Intensity, Dropoff, Color, etc.). In the next steps, you modify some of the attributes for the spotlight.

To modify the attributes of a spotlight

- 1 The spotlight's default Cone Angle is 40 degrees. In the Attribute Editor, set Cone Angle to 20.

The circle of light narrows.

- 2 Set Cone Angle to 60.

The circle of light widens. Rendering creates this result:

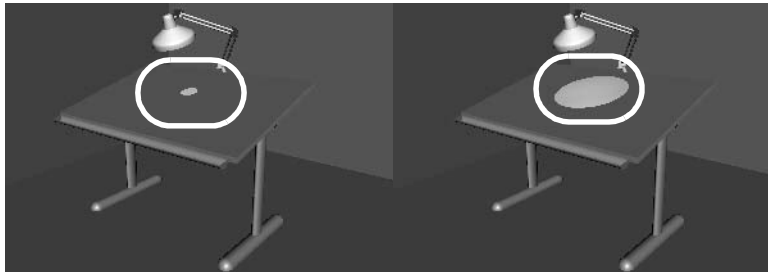

- 3 Set Dropoff to 10.

This attribute sets how much the light intensity diminishes from the center of the circular region out to the edge. Finding the right value is a matter of experimentation. When you increase the Dropoff, the light's intensity diminishes, so you need to increase the Intensity. For example, increase the Intensity to 1.6. Rendering creates this result:

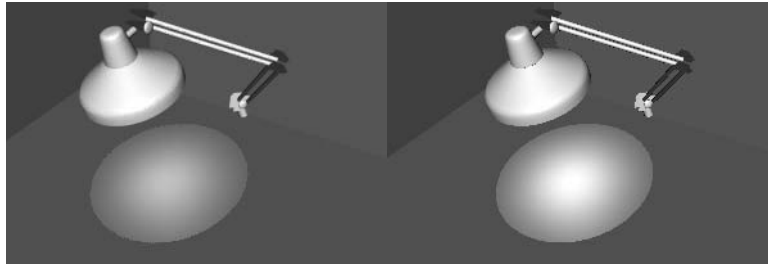

Dropoff = 10 Intensity = 1 Dropoff = 10 Intensity = 1.6

To mimic the way a light source's intensity naturally decreases with distance, you might want to select a Decay Rate to diminish the light's intensity. The Linear setting diminishes light with the least abruptness, Quadratic with the most abruptness. Cubic is between the two other settings.

The default setting is No Decay, which means the light remains at full intensity regardless of distance. If you use a setting other than No Decay, you likely will need to increase the Intensity. For this lesson, leave the Decay Rate set to No Decay.

4 Set the Penumbra Angle to 10.

This attribute controls the softness along the edge of the area of illumination provided by the light. Again, finding the right value is a matter of experimentation. You can also use negative numbers to fade inward from the circle's edge. The viewing angle of the camera influences the appearance of the fading at the edge. Rendering creates this result:

9 | Rendering

Lesson 3 > Editing light attributes

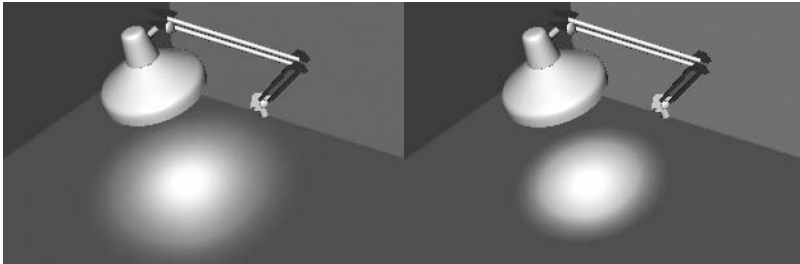

Penumbra Angle = 10

Penumbra Angle = -10

- 5 In the Light Effects section of the Attribute Editor, click the map button to the right of the Light Fog box.

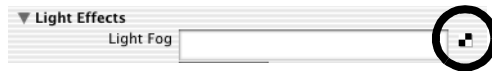

This gives the appearance of the light beams illuminating fog or dust in the air. Rendering creates this result:



Fog is more noticeable when you view (render) the light beam from a side angle rather than from above the light fixture

When you click the Light Fog map button, Maya creates a light fog node and displays its attributes in the Attribute Editor.

The Color and Density attributes are useful for altering the fog's hue and transparency. These attributes affect only the light on its way to the surface, not the light on the surface.

In the scene view, you'll also notice a Light Fog icon extending from the spotlight icon. When highlighted, it looks like this:

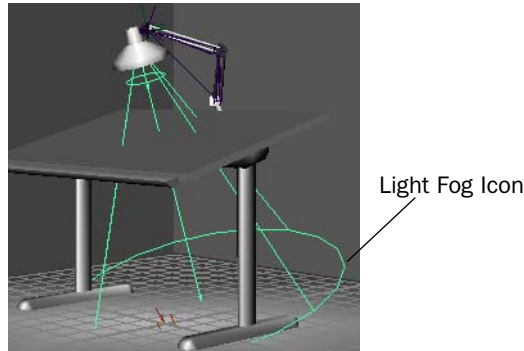

The icon displays the region of the potential illumination. You won't see light fog under the table. The table blocks the light fog because you previously turned on spotlight's Depth Map Shadows attribute. You can use the Scale tool on the icon to expand or contract the region of the illumination effect.

Shadows

Shadows are the darkened areas that appear on a surface when an object gets in the path of a light source. Shadows are cast onto the area of a surface that doesn't directly receive light. Shadows ground the objects in your scene and aid in defining their three-dimensional appearance. Shadows can add drama to your scene.

Next, you create a shadow on the floor from the light cast by the spotlight. To do this, you must edit a few of the spotlight's attributes.

To create shadows using a spotlight

- 1** Select the spotlight and click the spotLightShape1 tab in the Attribute Editor.
- 2** Set the Cone Angle to 105.

When you render the scene, you'll see the spotlight has widened its beam to light up a small part of the back wall. The table and light fixture block light and create shadows.

9 | Rendering

Lesson 3 > Shadows

The shadows occur because you turned on Use Depth Map Shadows for the spotlight earlier in the lesson.

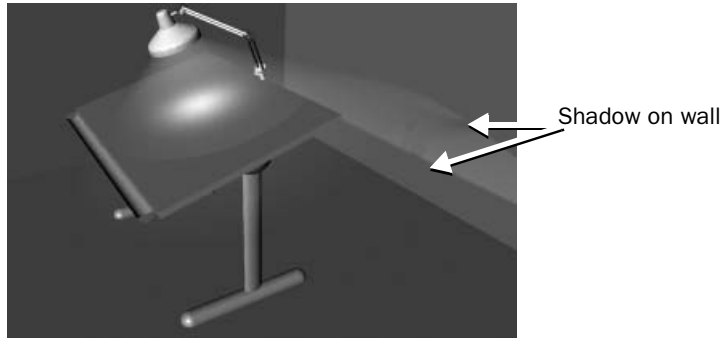

Depth Map Shadows refers to the algorithm Maya uses to produce shadows. For basic shadowing, you don't need to know about the algorithm, but you do need to make sure you turn on Use Depth Map Shadows.

- 3 To sharpen the shadow's edges, open the Attribute Editor's Shadows section and then the Depth Map Shadow Attributes section. Set the Dmap Resolution to 1024.

Rendering creates this result:

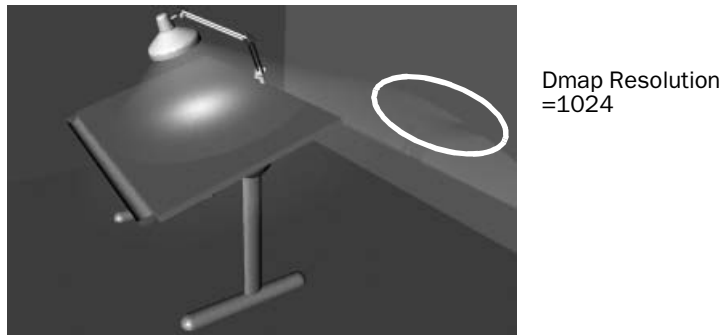

Increasing the Dmap Resolution increases rendering time. Use a higher value only if it makes a noticeable difference on the shadows. In this case, the difference is so subtle that you might prefer to use the default value 512. In your future projects, keep in mind that higher Dmap Resolution values can make a big difference in the quality, but also affect rendering time.

A related attribute, Dmap Filter Size, is useful for blurring or softening shadow edges that seem too sharp. Increase the value to increase the blur. Again, higher values increase rendering time.

If you are intent on perfecting shadows in your future projects, try various combinations of values for Dmap Resolution and Dmap Filter Size. For this lesson, the default values are satisfactory because the shadow edge has minimal contrast. If you create shadows with sharp contrast at the edges, altering the default values will be more desirable.

Creating additional cameras in a scene

Elsewhere in this book, you've used the default perspective camera to examine and render your modeling and animation work in progress. In some situations, it is convenient to create and use additional cameras.

For example, you might want to render the scene from two different camera views to compare the results. Alternatively, you might want to use the default camera for interactive modeling and animation and the second camera strictly for rendering the scene. In the next steps, you create an additional camera and manipulate its view of the scene.

To create a second camera for the scene

- 1** Select **Create > Cameras > Camera**. This creates a perspective camera with an icon representing it at the center of the grid.
- 2** In the Channel Box, change the name of the camera to **myCamera**.

Even though you've created a new camera, you are still looking at the scene through the default perspective camera named *persp*. You will view the scene through *myCamera* after you position it in the next step. If you were to view the scene through *myCamera* now, you would see a disorienting view of the back wall and floor. The camera's icon points in the direction of the camera's view.

9 | Rendering

Lesson 3 > Creating additional cameras in a scene

The scene's default persp camera has no icon. An icon is displayed only for a camera you create.

- 3 Use the Show Manipulator Tool to position myCamera roughly in this position:

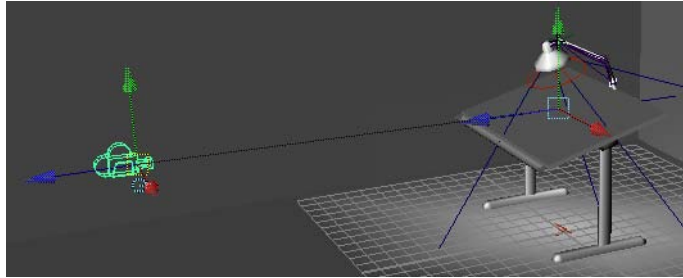

With a camera selected, the Show Manipulator Tool provides the same two manipulators that you used to position the spotlight: eye point and look-at point. The look-at point sets where the camera aims. The eye point sets the position of the camera.

You can select the current camera by selecting View > Select Camera.

- 4 Select Panels > Perspective > myCamera to view the scene from myCamera.

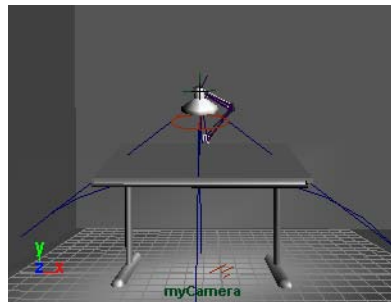

If your camera view is not similar to the above illustration, select tableGroup in the Outliner and select View > Frame Selection. This centers the view of myCamera on the table.

The dolly, track, and tumble movements work the same for myCamera as they do for the default persp camera.

You can return to the view of the persp camera by selecting Panels > Perspective > persp.

- 5** While working with a camera, it's useful to know the exact region of the myCamera view that is displayed in rendered images. To see the border of the render region, select View > Camera Attribute Editor. In the Attribute Editor, open the Display Options section and turn on Display Resolution. A rectangular border shows the region that will be rendered.
- 6** In the Film Back section of the Attribute Editor, set the Fit Resolution Gate setting to Overscan.

By enabling the Overscan, the view displays more of the region outside the area that will be rendered.

By displaying a small part of the scene that lies outside the rendered area, you can plan future camera movement more easily, especially if the scene has objects that move in and out of view.

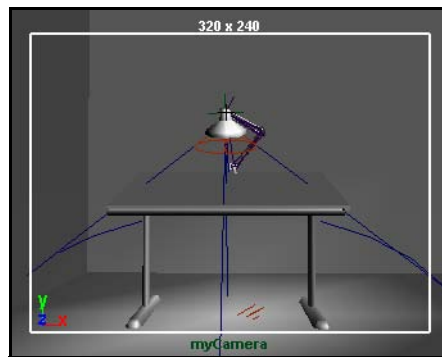

Animating camera moves

In Maya, the camera can be animated. You can set keyframes for the camera moves the same as for other objects in your scene. In the next steps, you set keys to do a simple animation of the camera's movement.

To animate the camera

- 1** Go to the start of the playback range.

9 | Rendering

Lesson 3 > Animating camera moves

- 2 Dolly, tumble, and track myCamera to create a view similar to this:

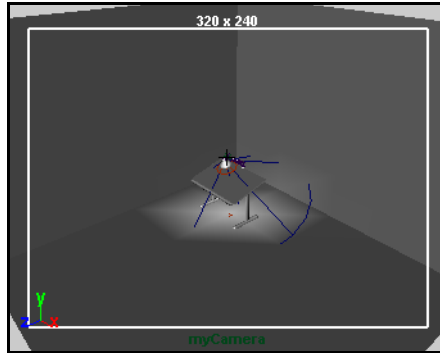

- 3 With myCamera selected, set a key for the camera's current view at the first frame. To set a key, select the Animation menu set, and then select Animate > Set Key. (For details on setting keys and animation technique, see "Lesson 1 Keyframes and the Graph Editor" on page 166.)

Tip

You can undo and redo view changes such as dolly, track, and tumble by selecting either the [or] bracket respectively. You can press these keys repeatedly to undo or return to a particular view orientation.

- 4 Go to frame 150.
- 5 Dolly myCamera to create a view similar to this:

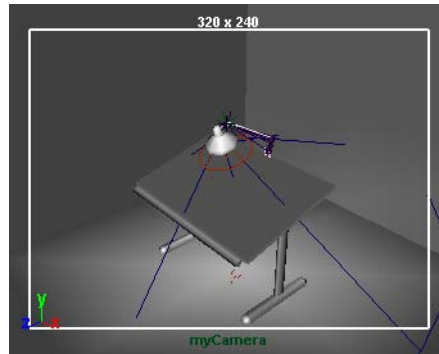

- 6** Set another key.
- 7** Play the animation to see the camera dolly toward the table for the first 150 frames.

At this point, feel free to experiment with keying changes in the view resulting from tumbling and tracking the camera. Excessive animation of tumbling and tracking creates a dizzying effect that is a common mistake of inexperienced artists. In general, it's best to keep camera animation simple except when you are striving for an unusual effect.

Beyond the lesson

In this lesson, you were introduced to some basic techniques related to lights and cameras in Maya. You learned how to:

- Place two types of lights in your scene and edit their attributes.

In addition to the directional light and spotlight you created in this lesson, Maya has several other types of lights for creating nearly any type of natural or artificial lighting. You might use as few as two lights or as many as 10 to get the look you want. Generally, the more lights you create, the longer the rendering will take.

In addition to the light fog effect you created in this lesson, you can also create Glow, Halo, and Lens Flare light effects with a similar workflow. To see these effects, the light must point toward the camera view.

9 | Rendering

Lesson 3 > Beyond the lesson

In some situations, you might want to prevent a light from striking a surface in its path. For example, your scene shows a person leaning against a wall in an outdoor night setting. You might want to light the wall with dark, shadowy spotlights, and the person's face only with a brighter, soft spotlight. Because the face and the wall are near each other, all the spotlights currently strike both objects. You can use Maya's light-linking capability to isolate the lighting.

- Create shadows in the scene by having the lights cast shadows.

The Maya software renderer has two types of shadows: Depth Map Shadows and Ray Traced Shadows. In this lesson, you created Depth Map Shadows, which are less realistic than Ray Trace shadows but much faster to render.

Ray Traced Shadows are mainly useful in scenes where the audience is focusing on the shadow region, for instance, a close-up of a still setting. Ray Traced Shadows are also useful if you want to cast shadows more accurately for transparent objects. To reduce rendering time, use Ray Traced Shadows only when necessary.

- Create and animate an additional camera from which to view the scene.

If you have previous experience with photography, you'll recognize the names of various camera attributes displayed in the Attribute Editor while a camera is selected. You can modify the attribute values to suit your requirements.

The values for certain camera attributes (for example, Film Aspect Ratio) might cause a rendered image to not match the region bounded by the Resolution Gate. In such cases, you can display the Film Gate (View > Camera Settings > Film Gate) to see the region that will be rendered.

You can animate a camera along a path; for example, to create the illusion of flying through mountainous terrain. This type of animation involves the use of Animate > Motion Paths > Attach to Motion Path (from the Animation menu set). If you additionally want the motion path-animated camera to focus on a stationary or moving object, you need to use Create > Cameras > Camera and Aim. If you want the camera to move in a looping path, (for example, a roller coaster) you need to use Create > Cameras > Camera, Aim, and Up.

Before you batch render a scene, you must select the camera you want to use for rendering. Select Window > Rendering Editors > Render Settings to display the Render Settings window. In the Image File Output section, select the camera from the Camera option.

Lesson 4 Global Illumination

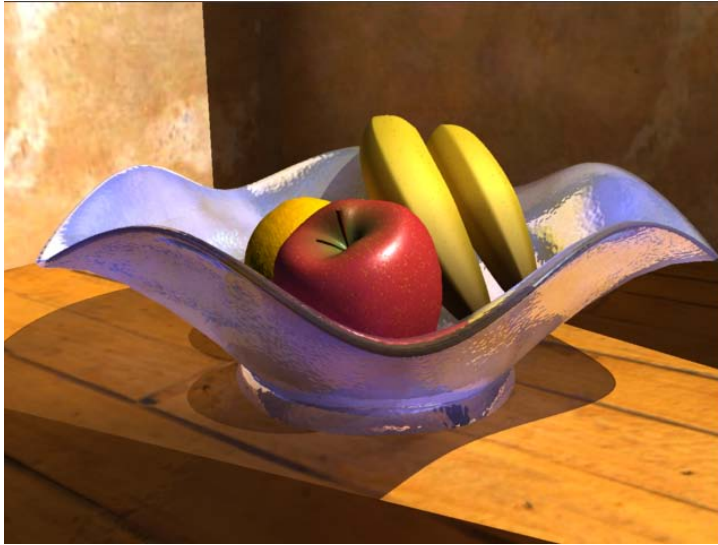

Image created by: Vivien May

The mental ray® for Maya® renderer can render using a feature called *Global Illumination*. Global Illumination simulates the effect of all lighting and inter-reflection in the scene, whether the items are lit directly by a light source or indirectly illuminated by other objects (and diffuse sources of illumination in the scene).

For example, when a photographer lights an object in a studio, some of the lighting for the object in the final image comes directly from the lights that are used, while additional illumination comes from objects that are placed near the subject to act as light reflectors. These are referred to as fill cards. Light bounces off the fill cards, indirectly lighting nearby objects with a secondary source of diffuse light. The color of the fill card colors the light that gets reflected onto the object. The final illumination of the object comes from this combination of multiple sources (direct light, specular reflections, and diffuse light).

9 | Rendering

Lesson 4 > Open the scene for the lesson

The Global Illumination feature in the mental ray® for Maya® renderer simulates this effect and provides for a realistic illumination simulation in your Maya scenes.

In this lesson you learn how to:

- Differentiate between images made with Global Illumination compared to other lighting types.
- Render an image using Global Illumination by performing repeated test renders to achieve a final result which includes:
 - Lighting a scene using the mental ray Global Illumination attributes.
 - Adjusting the Global Illumination attributes and quality settings in a systematic manner to achieve a high quality image.
- Visualize photon maps for the scene.

Open the scene for the lesson

In this lesson, you work with a scene we created for your use.

- 1 Make sure you've done the steps in "Preparing for the lessons" on page 372.
- 2 Open the scene named `GlobalIllum.mb`.

You can open the scene named `GlobalIllum.mb` from the *Maya Documentation, Lessons, and Extras CD* or from the drive where you copied the Getting Started files.



Shaded view

The scene contains a still life with a fruit bowl. Other surfaces act as the floor and walls for the scene. The primary light source is a spotlight. The spotlight casts light through a vertical opening in the wall. Some areas in the scene are directly lit and other areas are not.

Shading materials have already been assigned to the bowl, fruit, and other surfaces. The apple and orange models are from the previous lessons. If you want to see what other shaders and textures are in the scene, you can view them by opening the Hypershade editor.

When you render this scene using Global Illumination, the effect you want to achieve is to have the upper and lower regions of the scene receive indirect light: you want to be able to view more detail in the shadow areas as a result of the Global Illumination.

Render the scene using raytracing

To better understand the differences in a rendering performed using direct lighting methods vs. global illumination, you begin by rendering the scene using the mental ray for Maya renderer without using Global Illumination.

You start by performing some preparatory setup and then render the scene. In this section you:

- Select the mental ray for Maya renderer.
- Set the quality setting for your rendering.
- Set the image size for your rendering using the Image Size settings.

When performing repeated test renders, a good practice is to render small images so the tests render quickly.

- Turn on shadows for the spotlight in the scene.
- Render an image using the mental ray for Maya renderer using raytracing.

Using the mental ray for Maya renderer

To use the Global Illumination feature in Maya you must render using the mental ray for Maya renderer.

9 | Rendering

Lesson 4 > Render the scene using raytracing

To change the renderer to mental ray for Maya

To render using the mental ray for Maya renderer you need to change the rendering type from Maya to mental ray for Maya. You initially render the scene without using Global Illumination.

- 1 In the main menu, select Window > Rendering Editors > Render Settings (or click the Render Settings icon on the Status Line) to display the Render Settings window.



- 2 In the Render Settings window, set the Render Using setting to mental ray.

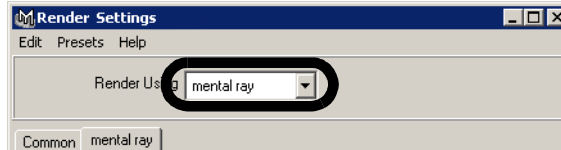

When you render an image it will now use the mental ray for Maya renderer.

Note When you switch between renderers in Maya (for example, Maya Software, Maya Hardware, and mental ray for Maya), the common Render Settings do not require re-setting.

When you perform repeated test renderings for a particular scene, consider the time it takes for each render to complete. If you reduce the time it takes to render each test image, the testing process proceeds much faster.

Setting render settings for raytracing

For the first rendering test, you render the scene to see how the scene appears without Global Illumination. The testing process proceeds faster if the quality level for the image is initially set low.

To set presets for rendering

- 1 At the top of the Render Settings window, select the mental ray tab and set the Presets setting to Draft.

The Draft setting ensures low anti-aliasing settings are used and reduces the rendering time compared to other preset settings. This is a good practice when evaluating the lighting and basic material properties in your test renderings.

**Setting the image size for rendering**

You set the size that an image is rendered in the Render Settings window. For this lesson, you render the image at a size that allows you to evaluate the Global Illumination effect.

To set the image size for rendering

- 1 At the top of the Render Settings window, select the Common tab and open the Image Size settings.

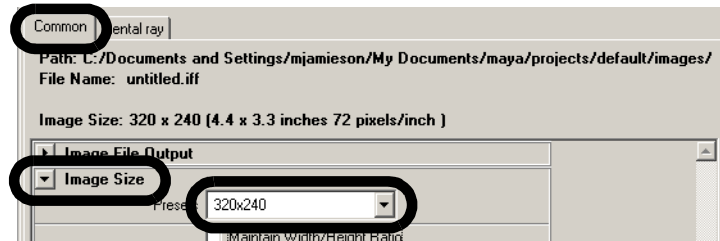

- 2 Set the preset to 320 X 240.
This sets a small image size for your rendering tests. The smaller image size renders in less time when compared to a larger image size.
- 3 Close the Render Settings window.

9 | Rendering

Lesson 4 > Render the scene using raytracing

Turning on shadows

Shadows add realism to a scene, and in this lesson, help to demonstrate how a scene rendered using Global Illumination differs from a scene rendered using direct illumination.

To turn on shadows for the spotlight

- 1 Open the Hypershade window (Windows > Rendering Editors > Hypershade) and click on the Lights tab to display the lights in the scene.

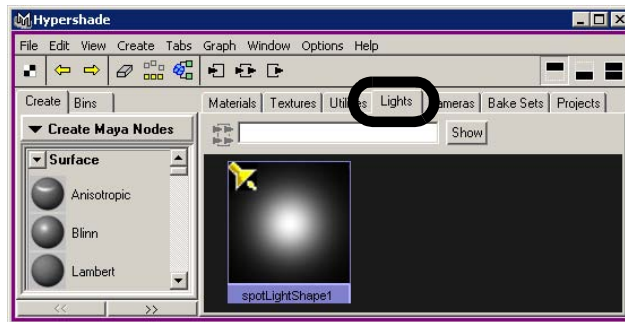

The scene is lit with one spotlight named spotLightShape1.

- 2 In the Hypershade window, double-click the icon for spotLightShape1 to display the attributes for the spotlight.
- 3 In the Attribute Editor, click the spotLightShape1 tab to display the lighting attributes for the spotlight. (You may need to minimize the Hypershade window to see all of the Attribute Editor.)
- 4 In the Shadows section, open the Raytrace Shadow Attributes turn on Use RayTrace Shadows. This turns on shadows for the spotlight.

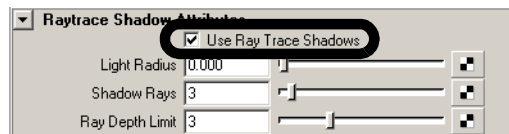

- 5 Close the Attribute Editor and Hypergraph window.

Rendering the image

When you render an image, all of the objects, lighting, shading materials, and image quality settings are used to calculate the image, based on the particular camera view that is set.

To render an image using mental ray for Maya

- 1** Click in the perspective window. This indicates which camera view you want Maya to render.
- 2** On the Status Line, click the Render Current Frame icon to launch the renderer to produce an image.



The Render View window appears and the fruit bowl scene renders using the mental ray for Maya renderer.

- 3** Once the render is complete, click the Keep Image icon in the Render View window to save this image.

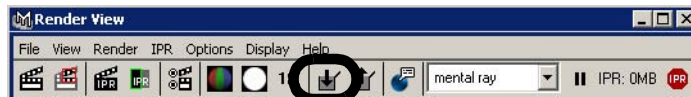

Keeping the image allows you to compare it to any subsequent test renders you produce. In this lesson you compare each rendered image to the previous ones to understand how the changes you make in various settings affect the rendered image.

9 | Rendering

Lesson 4 > Render the scene using Global Illumination



mental ray raytrace rendering

The rendered image shows the fruit bowl lit from the right of the frame. The upper and lower portions of the image are in shadow where the edges of the wall prevented the spotlight from lighting those portions of the scene. The shadow areas appear dark and do not show any detail of the floor or walls. This illumination effect is typical of an image produced with a single light source and direct illumination.

Render the scene using Global Illumination

To render using Global Illumination you need to turn on specific settings or *attributes*. There are two areas that you must initially set.

- Turn on the Global Illumination rendering attributes using the Render Settings Window.
- Turn on the Global Illumination lighting attributes using the Attribute Editor.

You initially render the scene using the attributes at their default settings to see how they affect the rendered image and then compare it to the previous raytrace rendering. As you gain more experience rendering with Global Illumination you will better understand what settings to initially use.

To turn on Global Illumination rendering attributes

- 1 Open the Render Settings window.
- 2 In the Render Settings window, select the mental ray tab and set the Presets setting to PreviewGlobalIllum.

Lesson 4 > Render the scene using Global Illumination



This turns on preset attribute settings that enable and control the quality of the Global Illumination. You initially render the scene using the default settings. Once you've rendered an image and observed their effect, you return to the Render Settings window and modify the settings accordingly.

- 3 Close the Render Settings window.

Global Illumination uses *photons* to simulate the light inter-reflection effects in a scene. Photons are small packets of energy emitted from a light source into the scene that bounce off surfaces to determine the intensity of light for those areas not receiving direct illumination. The renderer keeps track of the illumination that results from this photon emission in a file called a *photon map*.

In addition to having the spotlight emit light you need to set the spotlight to also emit photons for the Global Illumination simulation to occur. The overall illumination for the scene will be determined from a combination of the light's intensity and photon illumination from this single spotlight.

To turn on Global Illumination lighting attributes

- 1 Open the Hypershade window (Windows > Rendering Editors > Hypershade) and click on the Lights tab to display the lights in the scene.
- 2 In the Hypershade, double-click on the icon for spotLightShape1 to display the attributes for the spotlight.
- 3 In the Attribute Editor, click the spotLightShape1 tab to display the lighting attributes for the spotlight.
- 4 Open the mental ray section, and in the Caustic and Global Illumination attributes set the following settings:

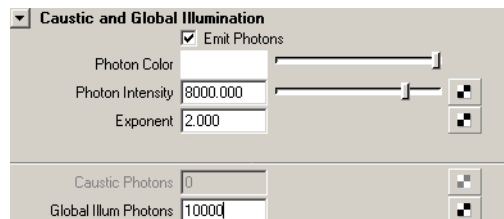

9 | Rendering

Lesson 4 > Render the scene using Global Illumination

- Emit Photons: On
- Photon Intensity: 8000
- Global Illum Photons: 10000

The spotlight emits photons into the scene when you next render an image. Photon Intensity sets the brightness of the Global Illumination. Global Illum Photons sets the number of photons that get emitted into the scene.

Setting a panel layout for rendering

The process of producing a rendered image usually involves rendering and evaluating successive test images to achieve the desired final image. This process involves adjusting many render quality, shading, and lighting settings in specific windows and panels. Opening and closing the various windows can become tedious.

Displaying the most frequently used windows and panels for rendering allows you to work more efficiently without having to open and close them repeatedly.

To set a panel layout for rendering

- 1 Close the Render View window.
- 2 From the perspective view's panel menu, select Panels > Saved Layouts > Hypershade/Render/Persp.

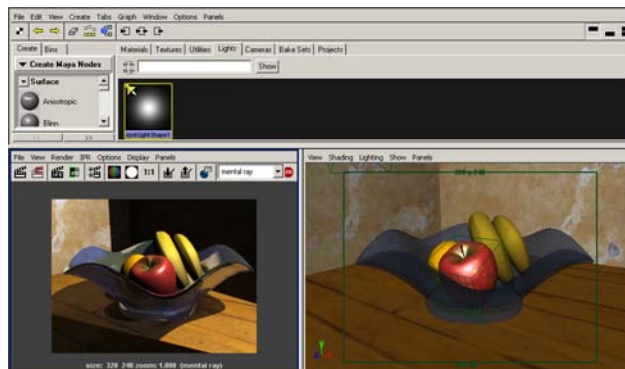

The panel layouts update to display the Hypershade window, Render View window, and Perspective view simultaneously. This allows you to easily work with these windows without having to open and close them repeatedly.

If the image in the Render View window appears pixelated as a result of the new panel layout, do the following:

- In the Render View window menu, select View > Real Size. This resizes the rendered image to its actual size.

Tip

You can resize the panels in a preset layout by dragging the border between neighboring panels using your left mouse button.

Rendering the scene with Global Illumination

Now that the lights are set to emit photons and the Global Illumination preset is selected, you're ready to render an a test image using Global Illumination.

To render the scene using Global Illumination

- 1 In the Render View window, click the Redo Previous Render icon to render the image with the default Global Illumination settings.



- 2 When the image has completed rendering, click the Keep Image icon to save the image.
- 3 Visually compare this rendered image with the previously rendered images.

9 | Rendering

Lesson 4 > Render the scene using Global Illumination

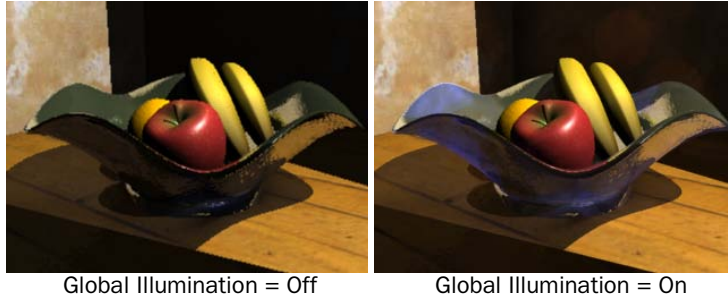

In this rendering, the shadow areas of the scene appear less dark as a result of Global Illumination. The bowl also appears more transparent than in the previous rendering.

The effect you want to achieve is to have the shadow regions receive indirect light; that is, you want to be able to view more detail in the shadow areas as a result of the Global Illumination. To do this, you must adjust the Global Illumination photon attributes. After you change an attribute, test render the scene to see the effect of this change in the rendered image. These repeated test renderings or *iterations* allow you to work systematically towards the goal of creating the desired final image.

In the next steps you use the Attribute Editor to increase the Photon Intensity to increase the overall Global Illumination for the scene.

Increasing the brightness of Global Illumination

Increasing the Photon Intensity setting increases the brightness of Global Illumination. The goal is to provide more visible detail and brightness in the shadow areas of the scene in the next test image.

To increase the Global Illumination lighting

- 1 In the Hypershade window, double-click on the icon for `spotLightShape1` to display the attributes for the spotlight.
- 2 In the Attribute Editor, click the `spotLightShape1` tab to display the lighting attributes for the spotlight.

Lesson 4 > Render the scene using Global Illumination

- 3 In the Caustic and Global Illumination attributes adjust the settings to the following:
 - Photon Intensity: 120000Increasing the Photon Intensity increases the illumination in the areas affected by Global Illumination.

To render the scene

- 1 In the Render View window, click the Redo Previous Render icon to render the image.
- 2 When the image has completed rendering, click the Keep Image icon to save the image.
- 3 Compare this rendered image with the previously rendered images.



Photon Intensity = 8000

Photon Intensity = 120000

The brightness of the illumination in this image has increased as a result of increasing the Photon Intensity. This is indicated by the increased brightness and details seen in the shadow areas of the scene. However, some circular spots have also appeared in the image along the dark wall behind the bowl. These spots are the result of low photon quality settings.

Adjusting the quality of Global Illumination

The quality of Global Illumination is primarily affected by three attributes:

- The accuracy of sampling (Global Illum Accuracy)
- The radius size that determines the size of the region surrounding a particular sampling point (Global Illum Radius).

9 | Rendering

Lesson 4 > Render the scene using Global Illumination

- The number of photons (Global Illum Photons).

In the next steps, you return to the Render Settings window and the Attribute Editor to increase the quality attributes that affect the Global Illumination effect.

To increase the Global Illumination quality settings

- 1 In the Render Settings window, open the Caustics and Global Illumination attributes and change the following Global Illumination attributes to:
 - Global Illumination Accuracy: 900
 - Global Illumination Radius: 2.5



The *Global Illumination Accuracy* setting determines how many photons will be evaluated to determine the Global Illumination intensity at a given sampling point. *Global Illumination Radius* determines the size of the region surrounding the particular sampling point. The more photons that get sampled, the more even the Global Illumination will appear in the final image.

Note As you increase the Global Illumination related quality and photon settings, the time to render the image also increases. Your goal should be to increase these settings just enough to achieve the desired image quality, without increasing them beyond what is required so that your rendering times are not adversely affected.

- 2 In the Render View window, click the Redo Previous Render icon to render the image.
- 3 When the image has completed rendering, click the Keep Image icon to save the image and then compare this rendered image with the previously rendered images.

Lesson 4 > Render the scene using Global Illumination



Global Illumination Accuracy = 64
Global Illumination Radius = 0

Global Illumination Accuracy = 900
Global Illumination Radius = 2.5

When the Global Illumination Accuracy and Radius values are increased, the resulting rendered image shows the circular spots have almost fully disappeared and the Global Illumination is much more uniform when compared to the previous rendering. Increasing the number of Global Illumination photons should aid in making the Global Illumination more uniform.

In the next steps, you increase the number of photons to provide a more uniform Global Illumination in the scene.

To increase the Global Illumination photons

- 1** In the Hypershade, double-click on the icon for `spotLightShape1` to display the attributes for the spotlight.
- 2** In the Attribute Editor, click the `spotLightShape1` tab to display the lighting attributes for the spotlight.
- 3** In the Caustic and Global Illumination attributes adjust the settings to the following:
 - Global Illum Photons: 80000

When you increase the number of Global Illumination Photons you are increasing the resulting density of the photon map that gets produced at the beginning of the render process. The more photons, the smoother the resulting Global Illumination. Increasing the number of photons also increases the rendering time.

9 | Rendering

Lesson 4 > Render the scene using Global Illumination

To render the image

- 1 In the Render View window, click the Redo Previous Render icon to render the image.
- 2 When the image has completed rendering, click the Keep Image icon to save the image and compare this rendered image with the previously rendered images.

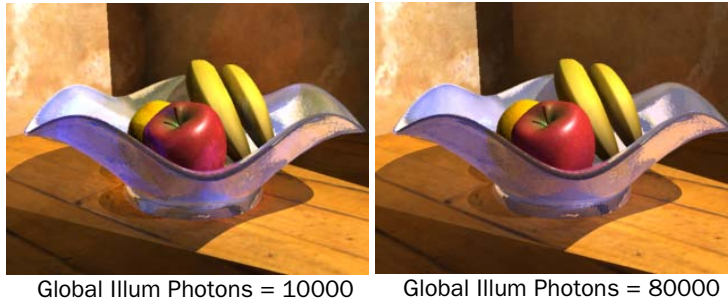

In this image, the circular spots that were seen in the previous renderings have disappeared. You can observe other Global Illumination effects compared to the original raytrace rendering:

- Many of the objects have received some additional color from neighboring objects in the scene as a result of the Global Illumination, an effect known as *color bleeding*. When color bleeding occurs, objects take on some of the color from neighboring objects as a result of the reflected and transmitted light.

Now that you've tested and refined the Global Illumination for a small image you can render a final image for the scene at a larger image size and increase the rendering quality settings.

To increase the image size and antialiasing

- 1 In the Render Settings window, select the Common tab and open the Image Size settings.
- 2 Set the preset to 640 X 480 to render a larger sized image.
- 3 In the Render Settings window, select the mental ray tab.

Lesson 4 > Render the scene using Global Illumination

- 4 Open the Anti-Aliasing Quality attributes and set the following Samples settings:



- Number of Samples - Min Sample Level: 0
- Number of Samples - Max Sample Level: 1

Sampling is the process for determining the amount of antialiasing that occurs. The Number of Samples attribute sets minimum and maximum limits for the amount of sampling that will occur for a given pixel area in the image. Modifying the anti-aliasing *Samples* settings will ensure that the surfaces in the rendered image appear smooth.

A Min and Max value of 0 and 1 should provide the correct amount of anti-aliasing sampling for this particular image at this image size.

To render a final image of the scene

- 1 In the Render View window, click the Redo Previous Render icon to render the image.



Final rendering using Global Illumination

9 | Rendering

Lesson 4 > Beyond the Lesson

Beyond the Lesson

In this lesson you were introduced to the Global Illumination features provided by the mental ray® for Maya® renderer. You learned that:

- The mental ray for Maya renderer provides a feature that simulates indirect illumination in the Maya scene called Global Illumination.
- Global Illumination allows you to achieve realistic lighting effects for objects and areas of the scene that do not receive direct lighting.
- Photons are used to measure the Global Illumination of the scene via the creation of a photon map.
- The brightness of the Global Illumination in a scene is controlled by the Photon Intensity.
- The quality of the Global Illumination effect is dependent on the number of photons emitted into the scene, the Global Illumination Accuracy, and the Global Illumination Radius attribute settings.
- Multiple test renders are often required to achieve the desired final image.

Light sources for Global Illumination

Point, spot, and mental ray area lights can be used as light types for Global Illumination with the mental ray for Maya renderer. A Directional light does not work as a source for Global Illumination because this light type does not have a defined point of origin (that is, the rays emit in a parallel manner).

Photon maps

You can visualize the photon mapping that occurs at the beginning of the rendering process provided you turn on the Enable Map Visualizer option in the Caustics and Global Illumination section of the Render Settings window. To view a visualization of the photon mapping, select Window > Rendering Editors > mental ray > Map Visualizer.

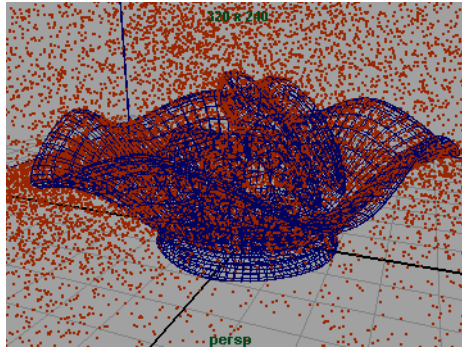

Visualization of the photon map

Visualizing the photon mapping can aid in determining whether the coverage and density of photons for the scene is appropriate for the resulting final image.

By default, the mental ray for Maya renderer rebuilds the photon map each time you render a scene using Global Illumination. If you are rendering a scene containing camera animation in which the objects and lights remain static, or rendering several iterations of a single image, you may consider turning off the Rebuild Photon Map setting in order to reduce the rendering times for each frame.

9 | Rendering

Lesson 5 > Beyond the Lesson

Lesson 5 Caustics



Image created by: Vivien May

Caustics are the light effects and specular patterns that are cast on surfaces as a result of focused light reflecting off highly reflective surfaces or refracting through translucent surfaces.

The light patterns that occur on the bottom of a swimming pool on a sunny day, or the bright areas that occur in the shadow of a glass object as light shines through it are examples of caustics.

The Caustic feature in the mental ray® for Maya® renderer simulates caustic effects in your Maya scenes. Caustics are similar to Global Illumination in that they are an indirect illumination effect.

In this lesson you learn how to:

- Create the shadow effect that results from the refraction and concentration of light through a transparent object, using the Caustic feature provided in the mental ray for Maya renderer.

Getting Started with Maya

458

- Adjust refraction level limits in order to achieve desired refractive effects with transparent objects.
- Systematically perform test renders and adjust the render and caustic quality settings in order to achieve a high quality image.

Open the scene for the lesson

In this lesson, you work with a scene we created for your use. In the first steps of this lesson, you open the scene and view the various elements that have been preset for your use.

- 1** Make sure you've done the steps in "Preparing for the lessons" on page 372.
- 2** Open the scene named `CausticStart.mb`.

You can open the scene named `CausticStart.mb` from the *Maya Documentation, Lessons, and Extras CD* or from the drive where you copied the Getting Started files.



The scene contains a still life with a translucent bottle and apples. Other surfaces act as the floor and walls for the scene. (The bottle appears opaque when viewed in shaded and textured display mode.)

Two lights illuminate the scene: a spotlight and a point light.

Shading materials have already been assigned to the models and surfaces. You can view the shaders and textures by opening the Hypershade editor.

9 | Rendering

Lesson 5 > Render the scene using raytracing

When you initially render this scene, the objects cast shadows onto the floor surface. Caustics are added to the lighting of the scene to create a more realistic shadow for the translucent bottle.

Render the scene using raytracing

To better understand the differences between caustics versus other lighting, you begin by rendering the scene using the mental ray for Maya renderer without using Caustics.

You start by preparing the scene and then rendering. In this section you:

- Set a panel layout for rendering
- Turn on shadows for the spotlight
- Turn on the mental ray for Maya renderer
- Set the image size for your rendering
- Set the image quality preset
- Render the image using raytracing

Setting a panel layout for rendering

Producing a rendered image usually requires that you render test images to achieve the final result. This may involve adjusting many render quality, shading, and lighting settings. Opening and closing the various windows can become tedious.

Keeping the most frequently used windows and panels open allows you to work more efficiently.

In the following steps, you select a panel layout to work more efficiently with the various panels and windows.

To set a panel layout for rendering

- From the perspective view's panel menu, select Panels > Saved Layouts > Hypershade/Render/Persp.

9 | Rendering

Lesson 5 > Render the scene using raytracing

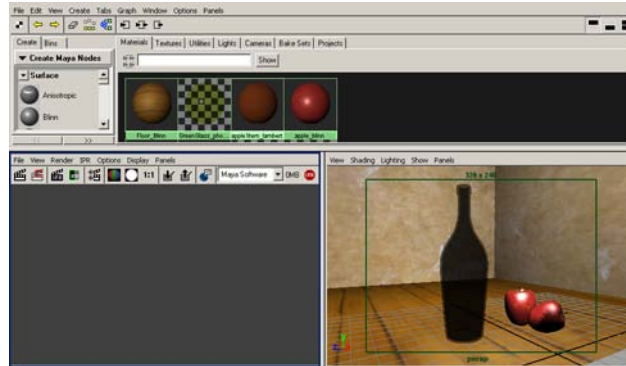

The panel layouts update to display the Hypershade window, Render View window, and Perspective view simultaneously.

When you render an image, it appears in the Render View window.

Tip You can resize the panels in a preset layout by dragging the border between neighboring panels using your left mouse button.

Turning on shadows

In this lesson, you learn how the bottle's shadow can be made to appear more realistic as a result of the caustics.

To turn on shadows for the spotlight

- 1 In the Hypershade window, click the Lights tab.

9 | Rendering

Lesson 5 > Render the scene using raytracing

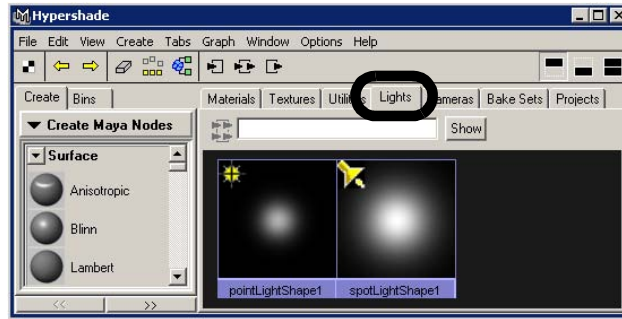

The Hypershade displays icons for the two lights in the scene.

- 2 In the Hypershade window, double-click the icon for spotLightShape1. The Attribute Editor appears.
- 3 In the Attribute Editor, click the spotLightShape1 tab to display the lighting attributes for the spotlight.
- 4 In the Shadows section, open the Raytrace Shadow Attributes and turn on Use RayTrace Shadows.

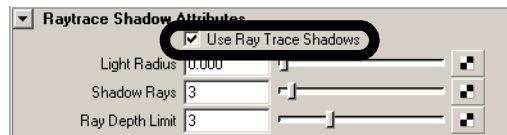

When you render the scene, shadows are cast by the spotlight.

- 5 Hide the Attribute Editor by clicking the Show/Hide Attribute Editor icon on the Status Line.



Using the mental ray for Maya renderer

To use the Caustics feature in Maya you must render using the mental ray for Maya renderer.

To turn on the mental ray for Maya renderer

- 1 In the main menu, select Window > Rendering Editors > Render Settings (or click the Render Settings icon in the Render View window).



- 2 In the Render Settings window, set the Render Using setting to mental ray.



Setting the image size for rendering

You set the size that an image will be rendered in the Render Settings window. For this lesson, you render the image at a size that allows you to evaluate the caustic effect.

To set the image size for rendering

- 1 At the top of the Render Settings window, select the Common tab and open the Image Size settings.

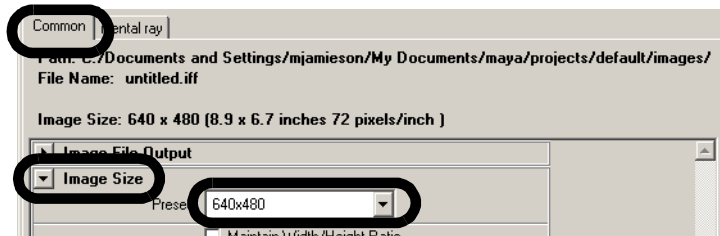

- 2 Choose the 640 X 480 preset from the Presets drop-down list.

9 | Rendering

Lesson 5 > Render the scene using raytracing

Setting render presets for raytracing

For the first rendering, you render the scene to see how the shadows appear without using caustics.

To set Render options for raytracing

- 1 In the Render Settings window, select the mental ray tab and set the Presets setting to Production Quality.



The Production preset ensures that the refraction level settings (found in Raytracing Quality section) are at a level high enough to render objects with translucency (for example, the bottle). The Production preset also sets the anti-aliasing level for the image.

- 2 Close the Render Settings Window.

Rendering the image

When you render an image, all of the objects, lighting, shading materials, and image quality settings are used to calculate the image, from the camera's view.

To render an image using mental ray for Maya

- 1 Click in the perspective window to indicate which view you want to render.
- 2 In the Render View window, click the Render Current Frame icon.



The bottle scene renders using the mental ray for Maya renderer and the image appears in the Render View window.

Tip If the rendered image appears either too small or too large in the Render View window, select View > Frame Image from the Render View menu to fit the image to the Render View.

- 3** Once the render is complete, click the Keep Image icon in the Render View window.



Keeping the image allows you to compare it to any subsequent test renders. In this lesson you compare each successive rendered image to the previous one to observe how the changes you make to render settings affect the rendered image.



Raytrace rendering

The rendered image shows the following:

- A translucent bottle with apples beside it casting shadows towards the rear of the scene. Notice how the shadows appear when raytrace rendered.
- The distortion of the table surface in the translucent glass effect based on the refractions and reflections.
- A dark region on the surface of the bottle. This results from the bottle reflecting the empty black area of the scene in front of it.

9 | Rendering

Lesson 5 > Render the scene using caustics

In the next section, you turn on the caustics rendering attributes and render the scene.

Render the scene using caustics

To render using caustics you need to turn on specific settings or attributes. There are two sets of caustic-related attributes that you must initially set.

- Turn on the caustics-related rendering attributes using the Render Settings window.
- Turn on the caustics-related lighting attributes using the Attribute Editor.

You initially render the scene using these attributes at their default settings to see how they affect the rendered image and then compare it to the previous raytrace rendering. As you gain more experience rendering with Caustics you will better understand what settings to initially use.

To turn on the caustics preset settings

- 1 In the Render Settings window, select the mental ray tab and set the Presets setting to PreviewCaustics.

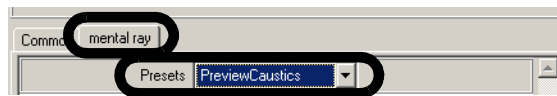

This turns on the presets that control the quality of the caustics.

- 2 Close the Render Settings window.

Mental ray for Maya uses *photons* to simulate the caustic effects in a scene. Photons are small packets of energy emitted from a light source into the scene. The photons travel throughout the scene, refracting through transparent objects or reflecting off reflective surfaces. The renderer keeps track of the illumination that results from this photon emission in a file called a *photon map*. The overall caustic simulation is determined from the photon calculations that result.

In addition to having the spotlight emit light into the scene you set the light to also emit caustic photons. The overall caustic effect is determined from the photon calculations that result.

To turn on the caustics lighting settings

- 1 In the Hypershade, double-click on the icon for spotLightShape1.

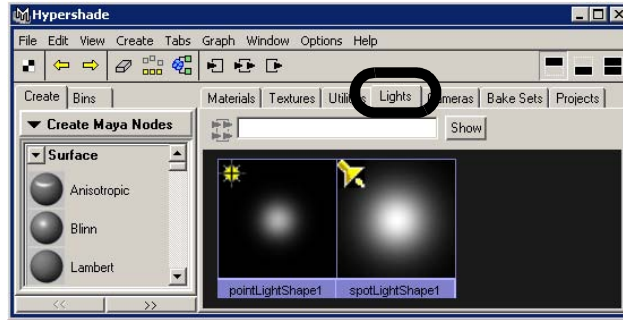

- 2 In the Attribute Editor, click the spotLightShape1 tab to display the lighting attributes for the spotlight.
- 3 Open the mental ray section, and in the Caustic and Global Illumination attributes set:
 - Emit Photons: On
 - Photon Intensity: 8000
 - Caustic Photons: 10000

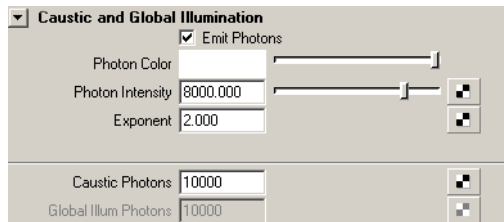

- 4 Hide the Attribute Editor.

Rendering the scene with caustics

Now that the lights are set to emit caustic photons and the caustics preset is turned on, you're ready to render an image using caustics.

9 | Rendering

Lesson 5 > Render the scene using caustics

To render the scene using caustics

- 1 In the Render View window, click the Redo Previous Render icon.



- 2 When the image has completed rendering, click the Keep Image icon.
- 3 Compare this rendered image with the previously rendered image.



Raytrace rendering



Default caustic settings

This image differs from the previous one in the following ways:

- The bottle appears more opaque. This indicates that the correct number of refractions may not be occurring. The Raytracing Refraction Level setting may need to be increased. When a different preset was selected (Production to Preview), the refraction levels changed.
- There are spotted areas on the table surface directly in front of the bottle. This can be corrected by adjusting the photon quality settings.
- The desired caustic effect in the shadow has appeared but is not very pronounced. You want to achieve an effect where the shadow has brighter regions as a result of light being refracted through the surfaces of the bottle.

Adjusting the refraction levels

When the refraction levels are set too low, light rays do not refract through all of the surfaces enough to provide a realistic indication of a translucent surface when raytraced. This results in the object appearing opaque when it should appear translucent.

Increasing the *Refractions* setting allows the renderer to calculate what is seen through the surfaces of the glass by allowing the light rays to refract the correct number of times.

In the next step, you change the Refraction settings so that the bottle will appear translucent when rendered.

To increase the refraction levels

- 1** In the Render Settings window, select the mental ray tab and then open the Raytracing attributes.
- 2** In the Raytracing section set the following:
 - Refractions: 6
 - Max Trace Depth: 8

The *Refractions* setting sets the number of times a light ray can be refracted. When the setting is too low the ray does not penetrate through all of the surfaces. The *Max Trace Depth* setting limits the total Refraction and Reflection settings. By setting it to 8, you ensure that two reflection and six refraction calculations can occur.

Photons refract in a manner similar to light rays when rendering. Increasing the Refractions setting for the Caustic Photons ensures that the renderer can correctly calculate the caustics that should occur with the bottle. In this case, matching the Caustic Photon refraction settings with the Raytracing refractions is a good practice.

To increase the photon refraction settings

- 1** In the Render Settings window, select the mental ray tab and open the Caustics and Global Illumination section.
- 2** In the Caustics and Global Illumination section set the following:
 - Max Refraction Photons: 6

9 | Rendering

Lesson 5 > Render the scene using caustics

- Max Photon Depth: 6

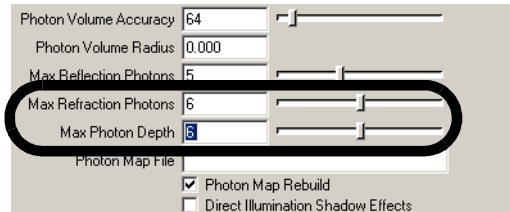

The *Max Refraction Photons* setting is similar to the Refractions setting for raytracing but sets the refractions for the Caustic photons. The *Max Photon Depth* setting limits the Refraction and Reflection calculations for the Caustic Photons to the limit set.

- 3 Close the Render Settings window.

Increasing the brightness of caustics

Increasing the Photon Intensity setting increases the brightness of the refracted caustic that appears in the shadow of the bottle.

To increase the Photon Intensity

- 1 In the Hypershade window, double-click the icon for `spotLightShape1` to display the attributes for the spotlight.
- 2 In the Caustic and Global Illumination attributes for the light adjust the settings to the following:
 - Photon Intensity: 36000

To render the scene

- 1 In the Render View window, click the Redo Previous Render icon to render the image.
- 2 Once the render is complete, click the Keep Image icon in the Render View window to save this image.
- 3 Compare this rendered image with the previously rendered images.

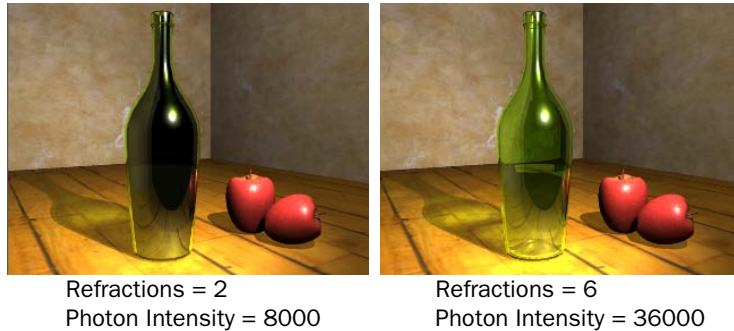

The translucency of the glass now appears more realistic. The caustic effect is more evident in the shadow of the bottle. However, the spotted effect, that appeared on the surface in front of the bottle, is more pronounced. These spots are the result of a low caustics quality setting.

Adjusting the quality of caustics

The quality of the caustic effects in a scene is primarily affected by the number of photons, the accuracy of sampling, and the radius surrounding the sampled area of illumination. (If you have previously completed the Global Illumination tutorial, you may notice similarities in this area.)

In the next steps, you return to the Render Settings window and the Attribute editor to increase the quality attributes that affect the caustics effect.

To increase the caustics quality settings

- 1 In the Render Settings window, open the Caustics and Global Illumination attributes and change the following Global Illumination attributes to:
 - Caustic Accuracy: 900
 - Caustic Radius: 1.5

9 | Rendering

Lesson 5 > Render the scene using caustics

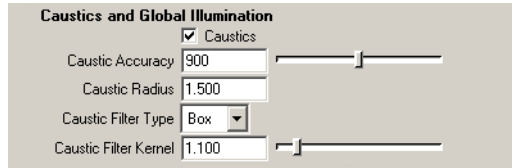

The *Caustic Accuracy* determines how many photons will be evaluated to determine the Caustic intensity at a given sampling point. *Caustic Radius* determines the size of the region surrounding the particular sampling point. The more photons that get sampled, the more realistic the caustic effect appears in the final image.

2 Close the Render Settings window.

Increasing the number of caustic photons that get emitted into the scene also increases the quality of the caustic effect. When you increase the number of caustic photons you increase the density of the resulting photon map that gets produced at the beginning of the render process. The more photons, the smoother the resulting caustics effect.

Note As you increase the caustic quality and photon settings so will the render time. Your goal should be to increase these settings just enough to achieve the desired image quality, without increasing them beyond what is required so that your rendering times are not adversely affected. Performing test renderings is the best method to determine these settings.

To increase the number of caustic photons

- 1 In the Hypershade window, double-click the icon for spotLightShape1.
- 2 In the Caustic and Global Illumination attributes, adjust the following settings:
 - Caustic Photons: 50000
- 3 In the Render View window, click the Redo Previous Render icon.
- 4 When the image has completed rendering, click the Keep Image icon and compare this rendered image with the previously rendered images.



In this image the bright spots in front of the bottle should be reduced when compared to the previous images. The caustic in the bottle's shadow should also appear more pronounced and more evenly illuminated.

Beyond the Lesson

In this lesson you were introduced to the caustic features provided by the mental ray® for Maya® renderer. You learned that:

- Caustics provide additional realism in a rendered image by simulating the focusing of light on diffuse surfaces as a result of the light reflecting off specular surfaces or via the refraction of light through translucent surfaces.
- Photons are used to determine the caustic effect in a scene via the creation of a photon map.
- The brightness of the caustic is controlled by the Photon Intensity attribute.
- The quality of the caustic effect is controlled by the number of photons emitted into the scene, the Caustic Accuracy, and the Caustic Radius attributes.
- Multiple test renders are often required to achieve the desired final image.

9 | Rendering

Lesson 5 > Beyond the Lesson

Light sources for caustics

Point, spot, and mental ray area lights can be used as light types for caustics with the mental ray for Maya renderer. A Directional light does not work as a source for Caustics because this light type does not have a defined point of origin (that is, the rays emit in a parallel manner).

Photon maps

You can visualize the photon mapping that occurs at the beginning of the rendering process provided you turn on the Enable Map Visualizer option in the Caustics and Global Illumination section of the Render Settings window. To view a visualization of the photon mapping, select Window > Rendering Editors > mental ray > Map Visualizer.



Visualization of the photon map

Visualizing the photon mapping can aid in determining whether the coverage and density of photons for the scene is appropriate for the resulting final image.

By default, the mental ray for Maya renderer rebuilds the photon map each time you render a scene using Caustics. If you are rendering a scene containing camera animation in which the objects and lights remain static, or rendering several iterations of a single image, you may consider turning off the Rebuild Photon Map setting in order to reduce the rendering times for each frame.

If you would like a more in-depth reference related to rendering in Maya, you may want to obtain: *Learning Maya: Rendering* available from the Alias online store.

10 Dynamics

Dynamics is a branch of physics that describes how objects move using physical rules to simulate the natural forces that act upon them. Dynamic simulations are difficult to achieve with traditional keyframe animation techniques.

Maya provides a means to do this type of computer animation where you set up the conditions that you want to occur, then let the software solve how to animate the objects in the scene. Maya® Dynamics™ provides the tools for creating effects that will enhance your final images and animations.

With Particle Effects, you can create the illusions of smoke, fireworks, rain, fire, and explosions.

With Rigid Body Dynamics, you can simulate real-world physical interactions between objects, such as collisions between surfaces. For example, you can simulate a bowling ball crashing through pins or simulate the effects of gravity when a ball falls to the ground. You can also simulate natural forces, such as wind.

This chapter contains the following lessons:

- “Lesson 1 Particles, emitters, and fields” on page 476
- “Lesson 2 Rigid bodies and constraints” on page 496

Preparing for the lessons

Do these steps to ensure the lessons in this chapter work as described:

- 1** Select File > New Scene to create a new scene before you start each lesson.
- 2** Select Window > Settings/Preferences > Preferences. Click Timeline under Categories and make sure the Playback Speed is set to Play every frame. Dynamic animation plays more accurately with this setting.
- 3** Select the Dynamics menu set. Unless otherwise noted, the directions in this chapter for making menu selections assume you’ve already selected the Dynamics menu set.

10 | Dynamics

Lesson 1 > Preparing for the lessons

Lesson 1 Particles, emitters, and fields

Particles are points that display as dots, streaks, spheres, or other shapes. Particles can have attributes applied to them so they animate and render to simulate natural phenomena.

You can create particles by clicking positions in the scene view, or you can create them with an emitter that shoots particles into view.

To animate particles, you typically apply fields such as gravity or wind. By combining emitters, particles, and fields, you can create natural phenomena such as smoke, fireworks, or rain.

In this lesson, you will be introduced to some of the basic concepts of particles and use particles, emitters, and volume fields to create a fountain-like effect. In this lesson, you learn how to:

- Create a particle emitter in your scene.
- Create a field to direct the movement of particles.
- Use a volume shape to control the movement of particles.
- Work with particle attributes.
- Color particles.
- Use a color ramp to add colors to the particles.
- Render the particles using hardware rendering.

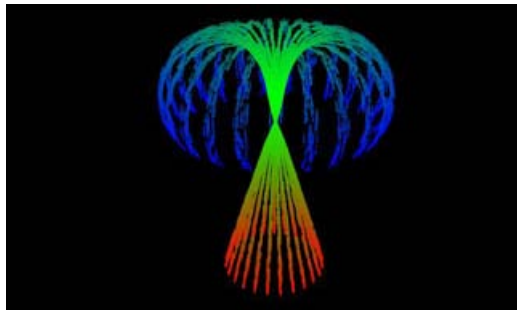

Creating an emitter

Emitters create particles as an animation plays. The emitter controls the position, direction, quantity, and initial velocity of the emitted particles when they are born. After particles are born, the attributes of the particle object control their appearance.

You can make a standalone emitter, or you can make a surface, curve, and even another particle an emitter. You move an emitter the same way you move any geometry, such as setting keys or parenting it to a moving object.

In the next steps, you create a circle and emit particles from it.

To create a particle emitter

- 1** Make sure you've done the steps in "Preparing for the lessons" on page 475.
- 2** Set the start frame to 1 and end frame to 120.
- 3** Select Create > NURBS Primitives > Circle > . In the options window, set the following options and click Create:
 - Radius: 4
 - Number of Sections: 25

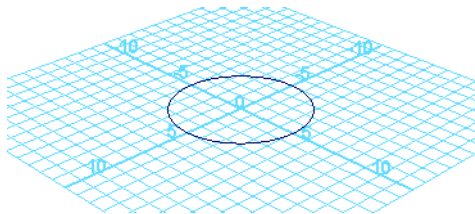

With Radius set to 4, the circle will be wide enough to see the particle emission clearly. With Number of Sections set to 25, the emission will be distributed evenly from points around the circle.

Note that the illustrations in this chapter show the grid with a custom blue color and numbered lines so that the shape and size of the objects you create are easier to distinguish. (If you want to change the grid color in your scene, select Display > Grid > .)

- 4** With the circle selected, select Particles > Emit from Object.

10 | Dynamics

Lesson 1 > Creating an emitter

By default, this creates an Omni emitter. If you dolly toward the center of the grid, you can see a tiny icon that represents the emitter. When you create an Omni emitter on a NURBS object, for instance, a circle, each control vertex (CV) of the object emits particles in all directions.

- 5 Play the animation for a few seconds to see the emission.

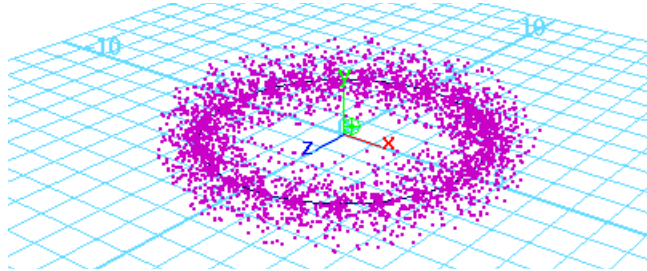

The particles begin to emit from the object. When you create any type of emitter, a *particle object* is automatically created and connected to it.

The connected particle object originally has no particles and is therefore invisible. As the animation plays and the emitter generates particles, the particle count of the connected particle object increases. When you go to the start of the animation, the particle count returns to 0.

Note that if you had created the circle with a smaller Number of Sections, there would be fewer CVs for the circle and therefore bigger gaps between the emission points on the circles.

- 6 Display the Outliner (Window > Outliner).
- 7 In the Outliner, select particle1.

This is the particle object. A particle object is a collection of particles that share the same attributes. You can create particle objects containing a single particle or millions of particles. Each particle in a scene belongs to some particle object.

The *particle object's* attributes define the appearance and other characteristics of the emitted particles. The *emitter's* attributes control the initial position, direction, quantity, and velocity of the emitted particles.

Creating volume axis fields

Fields are forces that you use to animate the motion of particles. With a Volume Axis field, you can move particles in various directions within the volume of a cube, sphere, cylinder, cone, or torus. With clever use of this type of field, you can create effects such as particles flowing around obstacles, solar flares, explosions, tornadoes, and rocket exhaust.

In the next steps, you'll use a volume axis field to move the particles up a conical path. When the particles exit the top of a conical region, you'll use another volume axis field to give them a downward arcing motion within a torus. The result resembles a fountain of light.

To create a cone volume axis field

- 1** With the particle object still selected, select Fields > Volume Axis > .
- 2** Set the following Volume Axis options and click Create:
 - Magnitude: 50
 - Volume Shape: Cone
 - Away From Axis: 0
 - Along Axis: -1

This creates a conical Volume Axis field that affects the motion of particles that enter or exist within its volume. Particles move in relation to a central axis within the volume. For a Cone Volume Shape, the central axis is the positive Y axis:

10 | Dynamics

Lesson 1 > Creating volume axis fields

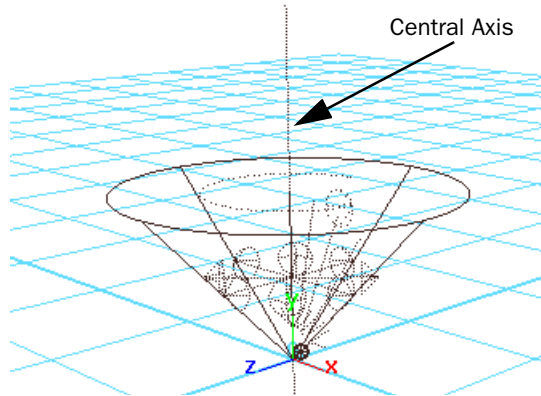

Using the axis attributes, you can specify that the particles:

- move in a direction roughly parallel to the axis toward or away from the point of the cone (Along Axis)
- radiate outward or inward relative to the axis (Away From Axis)
- swirl around the axis (Around Axis)
- move in a direction based on a combination of these directions

By setting Along Axis to -1 , the particles move toward the point of the cone. (A positive value would move particles in the opposite direction.) In the next step, you'll flip the cone 180 degrees so the aim of the cone and particles is upward.

By using 0 for the Away From Axis value rather than the default value of 1, the particles will not radiate away from the axis.

Note that you can use larger or smaller values for the Axis attributes to intensify or diminish movement.

Magnitude specifies the strength of the volume axis field. The greater the value, the more force is exerted on the particles.

You'll typically need to experiment with various Volume Axis field attribute values to achieve a desirable motion for particles. Be aware that small arrow-shaped icons within the Axis Field icon show which direction the particles will go.

- 3** With the Volume Axis field still selected, set the following values in the Channel Box:
- Translate Y: 13
 - Rotate Z: 180
 - Scale X: 5
 - Scale Y: 13
 - Scale Z: 5

This positions, rotates, and scales the volume axis field so that its base lies on the same plane as the circle emitter. Even though the circle emits particles in random directions, the volume axis field will redirect their motion up the cone.

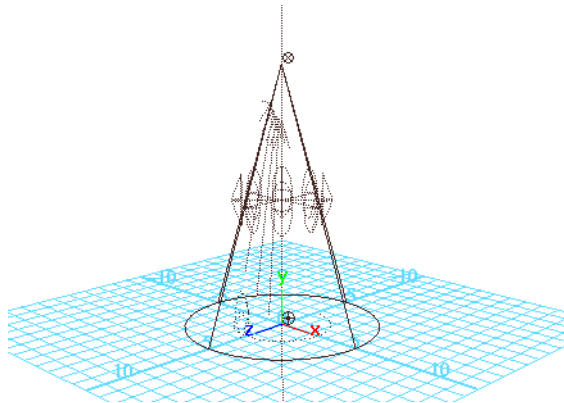

- 4** Go to the start of the playback range and play the animation for a few seconds.

10 | Dynamics

Lesson 1 > Creating volume axis fields

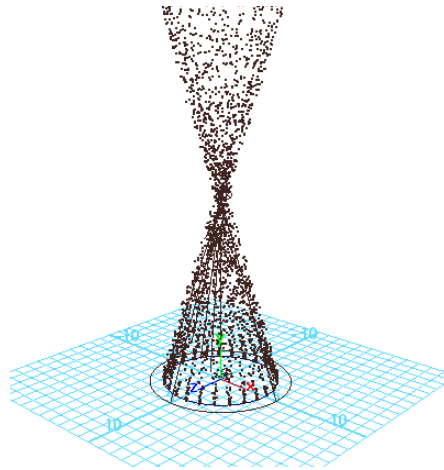

When the particles move out of the conical region, they continue in the same direction, mirroring the pattern of movement within the conical region. The volume axis field no longer controls the motion, but the particles continue with the same speed and direction they had at the moment they exit.

To create a torus volume axis field

- 1** In the Outliner, select the particle object
- 2** From the main menu, select Fields > Volume Axis > .
- 3** Set the following Volume Axis options and click Create:
 - Magnitude: 25
 - Volume Shape: Torus
 - Section Radius: 1.5
 - Away From Axis: - 0.7
 - Along Axis: 0.0
 - Around Axis: 2

The Torus Volume Shape creates a volume shaped like a doughnut.

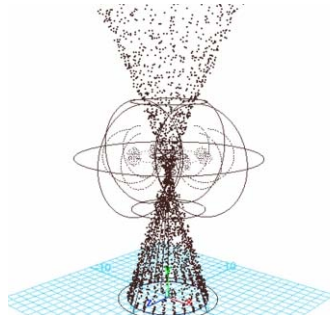

Section Radius defines the thickness of the torus.

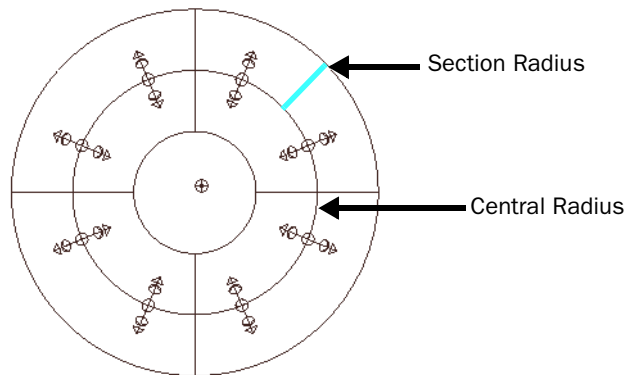

A value of 2 for Around Axis causes the particles to swirl around the central axis. For a torus, the central axis is the ring in the center of the solid part of the torus.

A value of -0.7 for Away From Axis cause the particles to move the radially toward the central axis.

When you later play the animation, the combination of these values cause the particles to loop up then down as if guided along the inner walls of a torus.

10 | Dynamics

Lesson 1 > Creating volume axis fields

Again, achieving the desired motion for particles within a volume axis field requires experimentation with attribute values. Examine the arrows and other small icons within the axis volume field to help get the desired results.

Note that the field's effect is pervasive enough that all particles passing through the hole of the torus are influenced by the field. You can cause particles to pass through the hole by altering the Max Distance and Attenuation.

4 With the torus volume field still selected, enter the following values in the Channel Box:

- Translate Y: 15
- Scale X: 3.6
- Scale Y: 3.6
- Scale Z: 3.6

This moves the torus volume field up 15 units and scales it larger. Finding the appropriate position for the volume axis field is a matter of experimentation.

5 Go to the start of the playback range and play the animation.

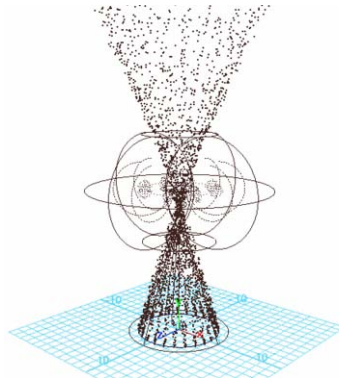

When the particles move through the top of the cone region, they spread outward somewhat but do not follow the shape of the torus volume field as specified in the prior steps. You'll correct this situation in the next steps.

Adjusting the velocity of moving particles

The torus volume axis field doesn't guide the motion of the particles as expected because the initial emission velocity of the particles dominates the motion of the particles rather than the field. You can use a particle object's Conserve attribute to scale down the emission velocity's influence and increase the field's influence.

To adjust the velocity of moving particles

- 1 Select the particle object and set the Conserve attribute to 0.8 in the Channel Box.
By changing the Conserve value from the default value, 1, to 0.8, the emission velocity's influence on the particle motion decreases and the field's influence increases.
- 2 Go to the start of the playback range and play the animation. Notice how the particle movement now conforms to the shape of the torus volume field.

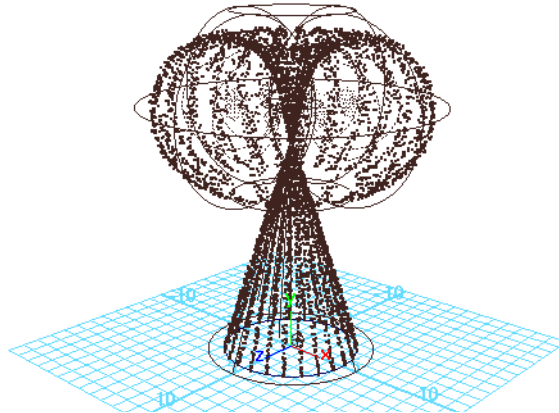

10 | Dynamics

Lesson 1 > Setting the particle render type

Setting the particle render type

The *particle render type* of a particle object determines how the particles look when rendered. For example, you can display particles as small spheres, streaks, or 2D images (known as sprites) of your favorite snapshot. Once you select the particle render type, you can add attributes specific to the render type to adjust the appearance.

To set the particle render type

- 1 With the particle object still selected, display the Attribute Editor, and select the particleShape1 tab.
- 2 Scroll down to the Render Attributes section, and set the Particle Render Type to Streak.
- 3 Go to the start of the playback range and play the animation.

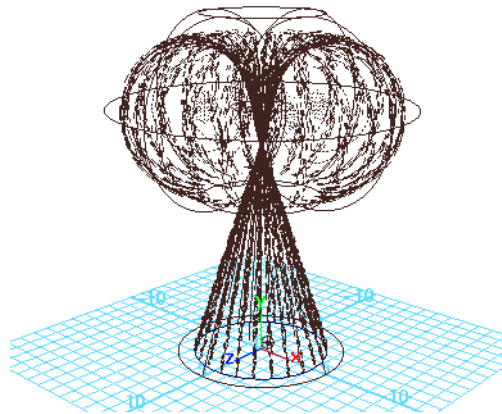

The Streak render type displays moving particles with an elongated tail. This render type enhances the display of objects such as meteors, and it's often used to create rain. The streak length is based on the velocity of the particle, so if the particles are stationary or moving slowly and the render type is set to streak, you won't see the particles.

Adding dynamic attributes

To maximize the display versatility of particle render types, you need to add built-in dynamic attributes to the particle object. When you add a dynamic attribute to an object, the attribute appears in the Attribute Editor for the selected object.

To add dynamic attributes

- 1 In the Attribute Editor, under the Render Attributes section, click the Add Attributes for Current Render Type button.
- 2 Observe the attributes that are added.

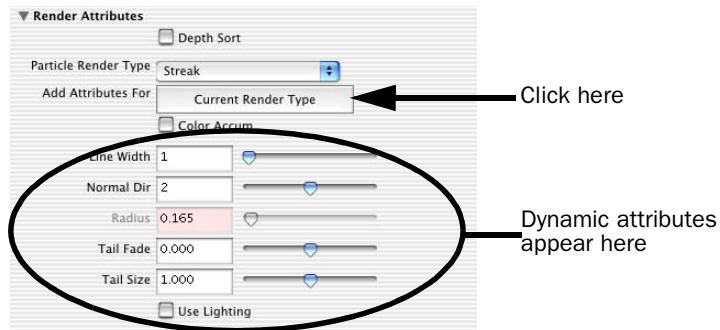

- 3 Set the following attributes:

Line Width	2	This sets the width of each streak.
Tail Fade	0.5	This sets the opacity of the tail fade; it can range from 0 to 1. A value of 1 makes the tail completely opaque; a value of 0 makes the tail transparent.
Tail Size	2	This scales the length of the tail. A value of 1 is the default length. Values less than 1 shorten the tail; values greater than 1 lengthen the tail.

You can experiment with these settings to change the look of the particles.

10 | Dynamics

Lesson 1 > Adding per particle attributes

Adding per particle attributes

Particle objects have two different kinds of attributes: per object and per particle.

A *per object attribute* lets you set the attribute value for all particles of the object collectively with a single value. For instance, the per object color attribute lets you set a single color for all the particles in the object.

A *per particle attribute* lets you set the value of the attribute individually for each particle of the object. For example, the per particle rgbPP attribute lets you set a unique color for each particle. Though there is only one rgbPP attribute in a particle object, the attribute holds the value for each particle's color value. The attribute holds the values in an *array*. An array is similar to a list. Arrays are appropriate for storing data which must be accessed in an unpredictable order, in contrast to lists which are best when accessed sequentially.

Although per particle attributes are best for creating complex effects, you can't keyframe them. You *can* keyframe per object attributes. In this lesson, you add a per particle color attribute so you can give different particles different colors.

To add a per particle color attribute

- 1** In the Attribute Editor, expand the Add Dynamic Attributes section, if necessary.
- 2** Click the Color button. The Particle Color box is displayed,
- 3** Turn on the Add Per Particle Attribute and click Add Attribute. Notice the rgbPP attribute that is added to the Per Particle (Array) Attributes section of the Attribute Editor.

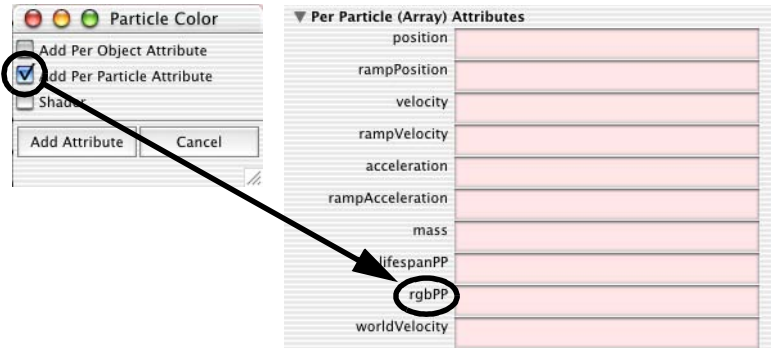

Adding color to particles with a color ramp

A ramp texture is a patterned 2D image in which the color blends from one shade to another. In the next steps, you use a color ramp to color the particles as they age.

To add color to particles using a color ramp

- 1 In the Attribute Editor, right-click the rgbPP data box and select Create Ramp from the drop-down menu.

This causes a default color ramp to color the particles as follows:

10 | Dynamics

Lesson 1 > Adding color to particles with a color ramp

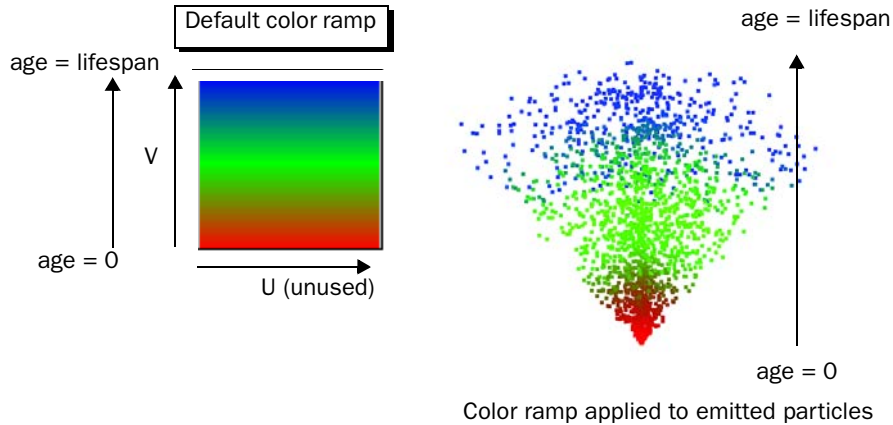

As each particle ages from its time of birth (emission), its color changes according to the ramp's color in an upward vertical (V) direction. The horizontal (U) direction of the ramp's color is unused in this lesson.

When you create the ramp, Maya adds a lifespan attribute and sets it to 1 second, by default. Each particle changes from red to green to blue over its lifespan of 1 second. The particle then disappears (*dies*).

- 2** From the perspective window menu, select Shading > Smooth Shade All. This enables you to see the colors of the particles the next time you play the animation.
- 3** Go to the start of the playback range and play the animation. Notice the particles never reach the end of the cone volume.

Lesson 1 > Adding color to particles with a color ramp

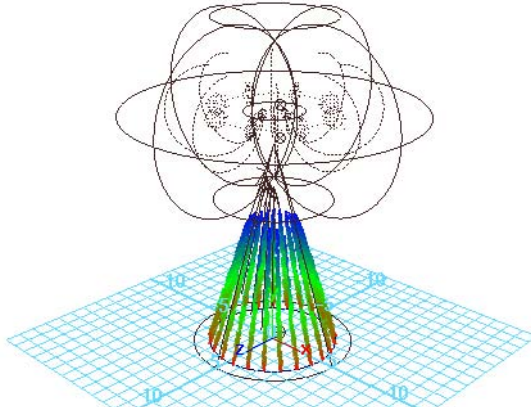

This is because the Lifespan is set to the default of 1, which is the number of seconds the particles exist in the animation.

- 4** In the Channel Box, set Lifespan to 3. Go to the start of the playback range and play the animation.

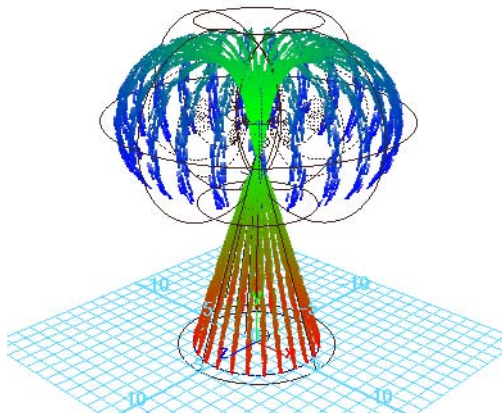

Because the particles live longer, they pass all the way through the cone and part of the way through the torus. The particles change from red to green to blue and disappear as they are born, age, and die.

10 | Dynamics

Lesson 1 > Hardware rendering particles

Hardware rendering particles

In 3D animation, rendering typically refers to the act of creating a sequence of high-quality image snapshots for each frame of an animation sequence. After rendering the images, you play them in sequence to create a film or video clip. If the concept of 3D animation rendering is new to you, consider doing the lesson "Rendering a scene" on page 373 before completing this section.

You cannot render most particle render types, including streaks, with Maya's software renderer. You must *hardware render* the particles.

Hardware rendering uses your computer's graphics hardware to render a scene to disk and monitor faster than software rendering. Hardware rendering generally displays surface shading and textures less accurately than software rendering, so most people use it only to render particle effects.

In the following steps, you test render the last frame of the scene to make sure the particles look satisfactory. Next, you render the entire frame sequence to disk and then play the rendered images with the flipbook feature.

To test render the scene

- 1** Select Window > Rendering Editors > Hardware Render Buffer. This displays a window from which you hardware render the scene.
- 2** In the Hardware Render Buffer, go to the start frame and click the play button. Stop the animation at frame 75.

You must play the particle animation from the beginning in order for particle effects to be displayed correctly at each frame. You cannot go directly to an arbitrary frame in the Time Slider and see correct results. Maya calculates particle animation sequentially frame-by-frame.

- 3** In the Hardware Render Buffer, select Render > Test Render.

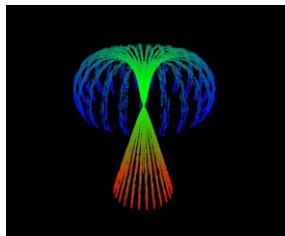

The streaks look smoother than they do in the scene view. You can improve the streaks even more as shown in the next steps.

- 4** In the Hardware Render Buffer window, select **Render > Attributes**.
The Attribute Editor appears.
- 5** In the Attribute Editor, under the Render Modes section, turn on **Line Smoothing**. This softens jagged edges when you hardware render **Streak** or **MultiStreak** render types.
- 6** To see the softened edges, select **Render > Test Render**.
If you click in the Hardware Render Buffer window, the rendered image disappears. If this occurs, select **Render > Test Render** again to redisplay the image.

To render the sequence and playback the results

- 1** In the Hardware Render Buffer window, select **Render > Attributes** to display the Attribute Editor.
- 2** Set the Hardware Render Buffer settings as follows:

Filename	Emit	This name will be the base of the filenames created when you render all frames to images on disk.
Start Frame	1	This specifies the first frame of the animation sequence to be hardware rendered.
End Frame	75	This specifies the last frame to be hardware rendered.

Other attributes in the Attribute Editor specify the image resolution, file format, lighting, and other display characteristics.

- 3** Make sure that no other windows overlap the Hardware Render Buffer or that your screensaver may accidentally launch while you use this feature. When you hardware render a frame sequence to disk, Maya renders whatever exists within the borders of the Hardware Render Buffer window.
- 4** In the Hardware Render Buffer window, select **Render > Render Sequence**.

10 | Dynamics

Lesson 1 > Beyond the lesson

This creates a series of files named Emit.0001, Emit.0002, and so on, through Emit.0075. These files are the rendered frames 1 through 75. Maya puts the files in your current project's *images* directory.

- 5 To play the hardware-rendered sequence, select Flipbooks > Emit.1-75.
- 6 Close the FCheck image viewing window when you are finished examining the animation.

Beyond the lesson

In this lesson you were introduced to a few of the basic concepts when using particles. You learned how to:

- Create particles from a source object called an emitter.
When you create any type of emitter, a particle object is also automatically created and connected to it. Emitters can be points (CVs, vertices), surfaces (NURBS, polygons), curves (NURBS curves) or volumes (spheres, cylinders).
- Control particles using fields, and volume objects.
With volume axis fields, you can funnel or swirl particles within the boundaries of common volumetric shapes. Although this lesson showed how to use a pair of volume axis fields to control the motion of particles, Maya has several other types of fields such as Gravity and Turbulence for simulating natural phenomena. You can use the fields to animate the motion of curves and surfaces in addition to particles.
- Change the color of particles using a ramp texture.
You can also change ramp colors by editing other ramp attributes, such as Noise and Noise Frequency. To do so, right-click the attribute box for rgbPP, then select arrayMapper1.outColorPP > Edit Ramp. See the Maya Help for details on ramp attributes. You can also control other particle attributes with ramps; for example, opacity. See the Maya Help for more information.
- Render particles using the hardware renderer.
The majority of particle rendering types are visible only when using the hardware render. Software rendering does not display them. However, if you use a particle render type of Bloppy Surface, Cloud, or Tube, you must render the particles using the software renderer as hardware rendering does not display those types.

If you create a scene that includes both particles and geometric surfaces, you may need to render the scene twice, once with hardware rendering and once with software rendering. In such cases, you'll need to composite the two sets of rendered images using a compositing software package.

Lesson 2 Rigid bodies and constraints

In Maya, a *rigid body* is a surface which has the attributes of an unyielding shape. Unlike conventional computer surfaces, rigid bodies collide rather than pass through each other during animation and are used for creating dynamic simulations. As well, rigid surfaces do not deform when they collide with other objects in Maya.

Rigid bodies can be created from polygonal or NURBS surfaces. Rigid body attributes can be assigned to the surfaces so they act and react in a simulation in specific ways. Examples of rigid body attributes are velocity, mass, and bounce.

To animate rigid body motion, you can use fields, keyframes, expressions, rigid body constraints, or collisions with particles or other rigid bodies.

Rigid body *constraints* restrict the motion of rigid bodies. The constraints simulate the behavior of real-world items you're familiar with, such as pins, nails, barriers, hinges, and springs.

In this lesson, you use create a rigid body dynamic simulation in which you drop a ball on some planks and watch the simulation in action. In this lesson you learn how to:

- Create objects with physical properties.
- Apply hinge constraints to objects so they react in specific ways.
- Set attributes for the rigid bodies to be either active or passive for the simulation.
- Play back a rigid body dynamic simulation.

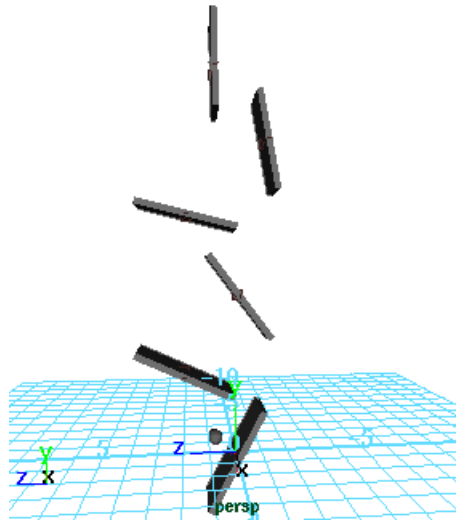

Lesson setup

You can create rigid bodies from NURBS surfaces and polygonal surfaces. In the following steps, you create some polygonal surfaces to be used for the rigid bodies.

To create polygonal objects for the rigid body simulation

- 1** Make sure you've done the steps in "Preparing for the lessons" on page 475.
- 2** In the Time and Range Slider, set the start frame to 1 and end frame to 200.
- 3** Select Create > Polygon Primitives > Cube > .
- 4** In the Polygon Cube Options window, select Edit > Reset Settings (to make sure the tool is set to its default, and then set the following options and click Create:
 - Width: 2
 - Height: 4
 - Depth: 0.25

10 | Dynamics

Lesson 2 > Lesson setup

- Axis: Z
- 5 With the polygon still selected, select Edit > Duplicate > .
 - 6 In the Duplicate Options window, select Edit Reset Settings. Set the following options and then click Duplicate:
 - Translate: 0 3 0
 - Number of copies: 5

This creates five copies of the polygon, each one placed 3 units above the lower one.

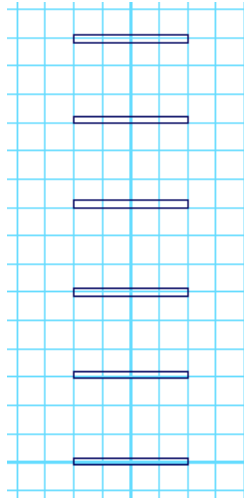

To position the objects for the rigid body simulation

- 1 Position the objects as shown in the side view in the following illustration. To position the planks precisely, select each plank individually and use the Channel Box to enter the appropriate value from this list:
 - pCube1 - Translate Z: 0
 - pCube2 - Translate Z: 2
 - pCube3 - Translate Z: 0
 - pCube4 - Translate Z: 2

- pCube5 - Translate Z: -1
- pCube6 - Translate Z: 1

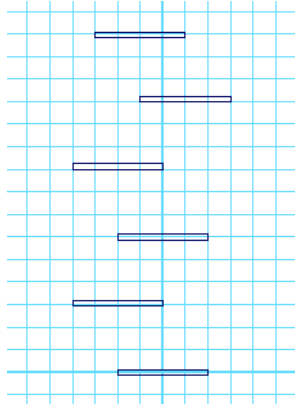

Creating hinge constraints

A Hinge constraint constrains rigid bodies along a specified axis. You can use a Hinge constraint to create effects such as a door on a hinge, a link connecting train cars, or a pendulum of a clock. In this example, the Hinge constraint constrains the plank to a position in the scene view.

In the following steps, you'll add Hinge constraints to the center of the planks, which automatically turns the plank into a rigid body. You will do this for each plank. By default, Maya automatically creates a rigid body when you use a field or rigid body constraint to control its motion.

To create a hinge constraint

- 1 Select **Soft/Rigid Bodies > Create Hinge Constraint >** .
- 2 In the Constraint Options window, set the following options:
 - Initial Orientation X, Y, Z: 0 90 0
 - Leave the options window open.

10 | Dynamics

Lesson 2 > Running a dynamics simulation

By default, the initial orientation is set to 0, 0, 0, which orients the hinge constraint to lie parallel to the Z-axis in world space. By setting the orientation to 90 in the Y-axis, the hinge constraint is rotated 90 degrees around the Y-axis, which orients the constraint parallel to the X-axis.

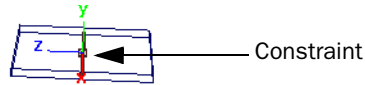

By leaving the Set Initial Position at its default setting, the hinge constraint is created at the rigid body's center of mass.

- 3** Select pCube1 and click Apply in the Constraint Options.
- 4** Select pCube2 and click Apply in the Constraint Options.
- 5** Repeat this until each of the six planks has a constraint applied to it.
- 6** Close the Constraint options window.

Running a dynamics simulation

In the next steps, you create a ball and add gravity to make the ball drop and hit the planks and then playback the simulation.

To create a ball for the simulation

- 1** Select Create > Polygon Primitives> Sphere > .
- 2** Set Radius to 0.2 and click Create.
- 3** In the Channel Box, set the Sphere's Translate Y value to 18.

To add gravity attributes to the ball

- With the sphere still selected, select Fields > Gravity.

When you connect Gravity to the sphere, it automatically makes the sphere an active rigid body. Gravity affects only the object that was selected when you add the Gravity field.

To run the dynamics simulation

- In the Time and Range slider, play the animation.
The ball falls and collides with the planks, which rotate about the hinge constraint.

Changing an active rigid body to passive

Maya has two kinds of rigid bodies—active and passive. An *active* rigid body is animated by dynamics—fields, collisions, and springs—not by keys.

Because the ball and planks are all active rigid bodies, gravity pushes it down and it rebounds after colliding with the planks.

A *passive* rigid body can have active rigid bodies collide with it. You can key its Translate and Rotate attributes, but dynamics have no effect on it.

In the previous steps, all the planks were active rigid bodies and reacted to the collision of the ball. In the following steps, you'll change the bottom plank to be a passive rigid body so the ball bounces off the plank but the plank doesn't react to the collision.

To change an active rigid body to a passive rigid body

- 1** Select pCube1 and display the Attribute Editor.
- 2** Click the rigidBody1 tab to display the rigid body attributes.
- 3** In the Rigid Body Attributes section, turn off Active to make pCube1 a passive rigid body. Hide the Attribute Editor.

10 | Dynamics

Lesson 2 > Beyond the lesson

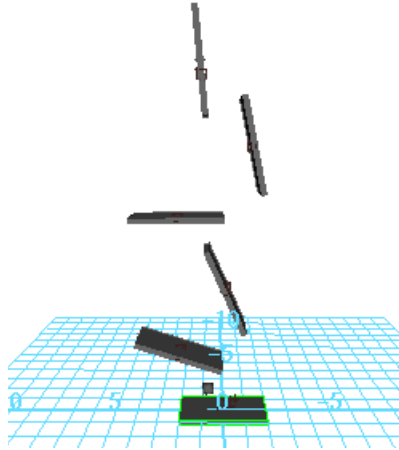

- 4 Go to the start of the playback range and play the animation.
Observe how pCube1 no longer reacts to the impact of the ball, but the ball continues to bounce off it.

Beyond the lesson

In this lesson you learned some fundamental concepts with respect to rigid body dynamics.

- There are differences between active and passive rigid bodies.
When a rigid body is passive, rigid bodies will collide with it but will not move it. You can control its movement by setting keys.
When the rigid body is active, you control its movement using dynamic forces, specifically fields and collisions. You can change the active and passive state of the rigid body to achieve various effects. For example, you can roll a ball off a table using keys (passive rigid body) then cause the ball to fall using gravity (active rigid body).
- How a hinge constraint can be used between an active rigid body and a position in the scene view

You can also create a hinge constraint between a passive rigid body and a position in the scene view, two rigid bodies, and an active and passive rigid body.

Other types of constraints include pin, nail, spring and barrier constraints. For additional information on the types of constraints and their usage, please refer to the Maya Help.

10 | Dynamics

Lesson 2 > Beyond the lesson

11 Painting

Maya provides painting tools that go above and beyond what many 3D creative artists might normally envision. These tools allow you to accomplish a wide range of modeling, animation, texturing, and effects work.

The painting tools are separated into three categories: Maya® Artisan™ brush tools, Maya® Paint Effects™ tools, and 3D Paint. If you completed the previous lessons in Getting Started with Maya, you already have experience with a few of these tools.

The Artisan brush tools have a variety of applications and allow you to directly modify attribute values interactively:

- In the NURBS modeling lesson, you used the brush tools to sculpt a simple face from a sphere.
- In the Character Setup chapter, you used Artisan brush tools to modify the skin weights on a surface mesh to ensure the character's joint deformed properly.
- In the Character Setup chapter, you used the Artisan brush tools to modify the cluster weights for Control Vertices to ensure a blend shape deformer worked predictably.

As you have seen, Artisan brush tools can also be used to select surface components. This selection method can dramatically improve the speed of your workflow.

Maya Paint Effects allows the user to create natural and fantastic effects either on a 2D canvas or as actual 3D objects in the scene.



Image created by: Martin Crawford

11 | Painting

> Preparing for the lessons

- Paint Effects enables you to create a 2D backdrop for your scene, or a dynamic 3D paint effect such as a field of grass, with flowers and a wind-blown tree—all at the drag of your mouse or tablet pen.
- Paint Effects comes with a suite of preset brushes to enable you to create many types of 2D and 3D effects.

With 3D paint, you can paint and modify textures directly onto 3D surfaces using both the Artisan and Paint Effects tools. You can paint texture attributes such as color, transparency, and bump, to name but a few.

As you have already gained some experience with the Artisan brush tools, this chapter focuses on Paint Effects and 3D Paint. It includes the following lessons:

- “Lesson 1 Painting in 2D using Paint Effects” on page 507
- “Lesson 2 Painting in 3D using Paint Effects” on page 521
- “Lesson 3 Painting textures on surfaces” on page 554

Preparing for the lessons

To ensure the lessons work as described, do the following:

- 1** Consider doing the lessons in Chapter 9, “Rendering.” Familiarity with Maya rendering concepts is important to understanding the following lessons.
- 2** Select File > New Scene to create a new scene.
- 3** To use all available screen space, maximize the Maya window.
- 4** From a panel menu bar, select Panels > Layouts > Single Pane.
- 5** Select the Rendering menu set. Unless otherwise noted, the directions in this chapter assume the Rendering menu set is selected.

Lesson 1 Painting in 2D using Paint Effects

One of the features of the Paint Effects Tool is the ability to paint colors, patterns, and textures on a 2D canvas image. You can use the image as an independent piece of art, a background image in your scene, or a texture to be applied to a 3D surface.

In this lesson, you learn how to:

- Display the 2D canvas.
- Paint strokes on the canvas, and modify your paint brush.
- Use the Visor to access the many pre-defined paint brushes.
- Modify brush settings such as brush size, color, and transparency.
- Modify the canvas size.
- Smear, blur, and erase brush strokes from the 2D canvas.
- Use the pre-defined Paint Effects brushes to paint flowers and foliage.
- Save modified brush settings to the Shelf.
- View the alpha channel for your 2D image.

Painting strokes

In the following steps, you display the 2D canvas and use preset brushes to paint a few strokes.

Although not covered in this lesson, you can use a tablet and stylus to paint with pressure sensitivity. The harder you press down, the more paint is applied.

To paint strokes on the 2D canvas

- 1** Do the steps in "Preparing for the lessons" on page 506.
- 2** If you want to create maximum space in the Maya window, turn off Display > UI Elements > Channel Box/Layer Editor, Tool Settings, and Attribute Editor.
- 3** On the view menu bar, select Panels > Panel > Paint Effects (hotkey 8).
The panel displays a Paint Effects toolbar and menus.

11 | Painting

Lesson 1 > Painting strokes

- 4 From the Paint Effects menus, select Paint > Paint Canvas to display the 2D canvas.
You're ready to start painting. It is not possible to display a grid on the canvas.
- 5 Paint a stroke by dragging across the canvas.



When you first display the Paint Effects panel, your strokes use the *default brush*—a solid black stroke similar to an airbrush.

Tip You can dolly and track the canvas using Maya's standard mouse and keyboard conventions.

- 6 Now paint with various preset brushes. To select a preset brush, select Brush > Get Brush or click the following button in the toolbar: 

The Visor window opens.

The Visor organizes the hundreds of Paint Effects brushes into category folders. In the Visor, click a folder, then click a brush icon in the area to the right of the folders. (The name of each preset brush has the extension `.mel` because each is

a MEL script that establishes the brush's operation characteristics.) You can dolly within the Visor window to enlarge the viewable size of the brush icons and read the names more clearly.

You can copy a brush or all brushes within a folder to the Shelf. Use the middle mouse button to drag the brush or folder to the Shelf. Use the shelf editor (available from the arrow menu at the left of the shelf) to remove items from the shelf.

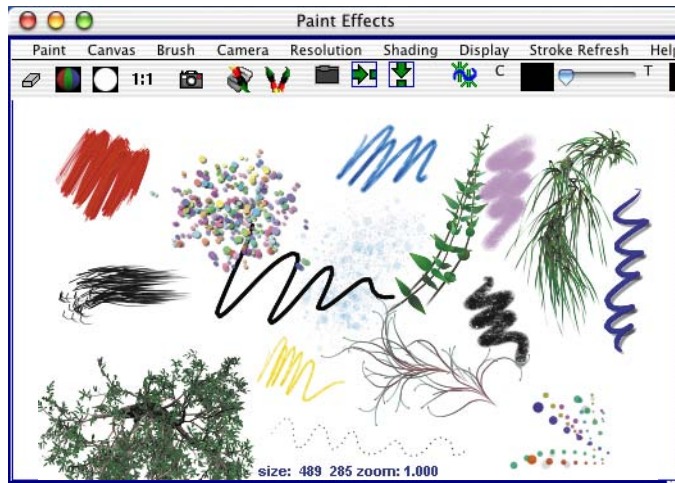

Some brushes apply paint directly along the paint path, while others produce added effects. For example, the pens folder includes brushes such as `ballpointRed.mel` that work like pens, while the flowers folder includes brushes such as `dahliaPink.mel` that grow flowers as you drag the mouse. Brushes like `dahliaPink.mel` use Paint Effects *tubes*.

- 7** Select the `dahliaPink.mel` brush and drag the mouse slowly for one stroke, then quickly for the next stroke.

When you paint a stroke slowly, the density of flowers is higher than when you paint quickly. The effect of stroke speed on density works the same for all brushes that use tubes.

- 8** To erase your last stroke, select Canvas > Canvas Undo.

11 | Painting

Lesson 1 > Modifying the default brush settings

When displaying the 2D canvas, you can undo only a single stroke. Edit > Undo (on the main menu) doesn't undo strokes.

- 9 To erase the entire canvas, select Canvas > Clear or click the Canvas Clear button on the toolbar:



Modifying the default brush settings

When you select a preset brush, Maya copies its brush settings to a *template brush*. A template brush is a holder for the attribute settings of the next strokes you paint. When you change the settings of the template brush, they affect only the next strokes, not previous strokes.

To edit the template brush settings

- 1 Select Brush > Reset Template Brush to select the default brush, then paint on the canvas so you remember the brush effect.
- 2 Select Brush > Edit Template Brush or click the following button in the toolbar:



You can edit various brush settings, for example, the brush width, in the window that appears.

- 3 To resize the brush, change the Global Scale value. Alternatively, you can move the brush over the canvas, press and hold the b Hotkey and drag left or right. The circle on the canvas represents the size of your brush.
- 4 Paint on the canvas to try out a new size.

11 | Painting

Lesson 1 > Modifying the default brush settings

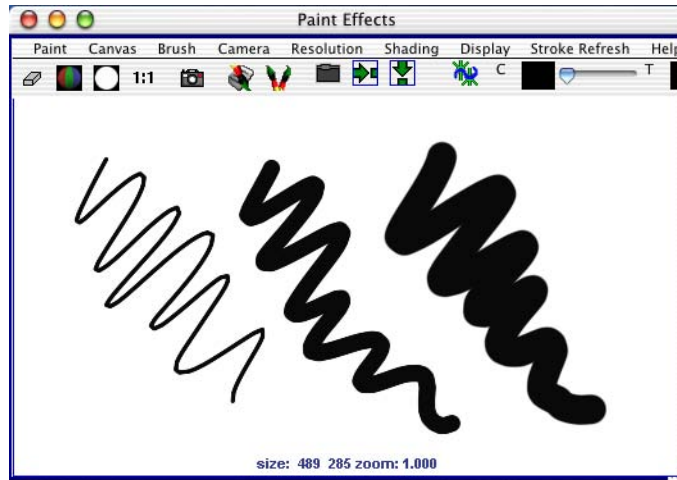

- 5** Close the Paint Effects Brush Settings window.
- 6** On the toolbar, click the swatch to the right of C (color) to display the Color Chooser.
- 7** Select a color from the Color Chooser and paint on the canvas.
- 8** On the toolbar, slide the T (transparency) slider to the right until the T box is a light gray. Paint on the canvas.

When you paint over existing paint strokes you will notice that your paint is transparent allowing the previous strokes to show through.

11 | Painting

Lesson 1 > Modifying the canvas

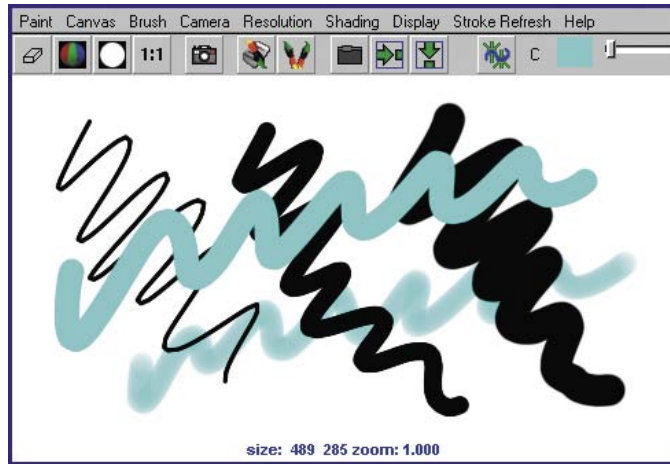

Note The Toolbar color boxes, for example, C and T, are also available in the Paint Effects Brush Settings window. (Select Brush > Edit Template Brush > Shading.)

Modifying the canvas

In the next steps you change a few canvas options, including color and size.

To modify canvas settings

- 1 Clear the canvas (Canvas > Clear).
- 2 Select Canvas > Set Size and set the canvas size to 512 x 512—the width and height in pixels. When you are prompted to save, click No, then close the Set Canvas size window.

Although you'll often use the default maximum canvas size to take advantage of the available screen space, you might need to use a smaller or larger size in many circumstances. For instance, if you plan to use the image as a background in a computer game, you might need to use a small canvas size such as 256 by 256.

- 3** Turn on the wrap buttons on the toolbar: 
- 4** Paint strokes past the edges of the canvas.

The strokes wrap around to the opposing side. This feature is useful for creating patterned texture images to be applied to surfaces. When you tile or repeat the image on the surface, the wrapped strokes help make the borders between the images unnoticeable.

If you want to display the area of the canvas where the edges join, you can do this using the roll feature (Canvas > Roll).
- 5** Select Canvas > Clear > . In the options window, slide the Clear Color slider all the way to the left. Click Apply.

This clears existing strokes and turns the canvas black. Before you paint strokes on the black canvas, you may notice that some brushes seem to have no effect. If this occurs, it's because the paint is black or because it is transparent enough to prevent the color from showing.

Modifying the colors of a preset brush

In the following steps, you alter leaf and bud colors of a preset brush; fern.mel.

Tip When using the fern.mel brush, if any of the sliders do not appear, or appear cut off on the right, you need to increase the screen display resolution setting on your monitor to 1280 X 1024.

To change the color of a brush

- 1** In the Visor (Brush > Get Brush), click the fern.mel preset brush in the plants folder.
- 2** Paint on the canvas to see the default display.

Because fern.mel uses tubes, ferns grow along the path of your stroke.
- 3** Resize the brush to a Global Scale of about 0.5 (Brush > Edit Template Brush) and paint on the canvas.
- 4** On the toolbar, click the L1 color box (Leaf Color 1), select a shade of blue from the Color Chooser, and leave the Color Chooser open.

11 | Painting

Lesson 1 > Modifying the colors of a preset brush

L1 sets the color of the tips of the leaves.

- 5 Click the L2 color box (Leaf Color 2) and select a shade of red from the Color Chooser.

L2 sets the color of the base of the leaves.



- 6 Click the B color box (Bud Color) and select a shade of yellow from the Color Chooser. B sets the color of the flower buds.
- 7 Paint on the canvas and observe how the changes you've made to the settings affect the final paint effect.

Tip

You can change the path width of fern.mel without changing the width of the leaves and stems. Select Brush > Edit Template Brush to display the Brush Settings window, then in the Brush Profile section, change the value of Brush Width. Similarly, you can alter the path width for any other preset strokes with tubes.

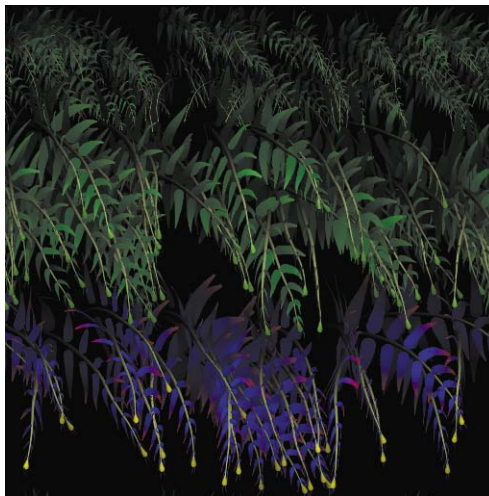

- 8** Clear the canvas (Canvas > Clear).

Editing strokes with tubes attributes

Now you'll edit the attributes that specify the foliage that grows along the path with fern.mel.

To edit tube attributes

- 1** To edit brush settings, select Brush > Edit Template Brush.
- 2** Open the Tubes section, then open Growth.
By default, only Leaves and Buds are created as you paint. You can also create Branches, Twigs, and Flowers to simulate a fern in various stages of its natural life cycle.
- 3** Turn on Flowers. Paint on the canvas to see the result.
- 4** Open the Leaves section, change Leaves in Cluster to 4, then paint on the canvas.
Leaves are created in radial clusters around a branch or twig. This setting defines how many leaves are in each cluster. The higher the number, the denser the foliage.
- 5** To make the flowers point in a different direction, open the Behavior section and then the Forces section. Set Path Follow to 0.1.
- 6** Paint to see the result.

11 | Painting

Lesson 1 > Saving brush settings for future use

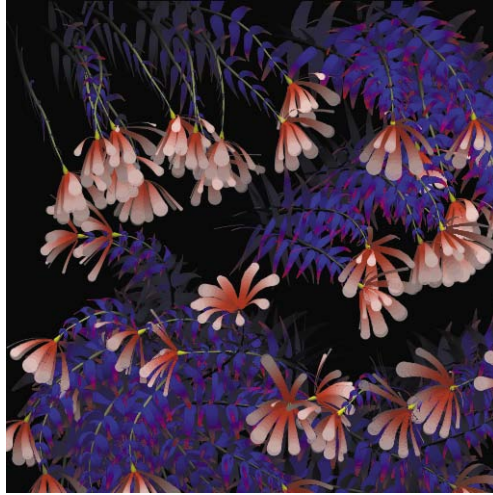

Saving brush settings for future use

When you first selected the preset brush `fern.mel` previously, Maya copied it to the template brush. You then edited the color and various other attributes of the template brush to create a unique ferns brush. The next steps show how to save the current settings of the template brush for future use.

To save a brush to the Shelf

- 1** On the main menu bar, select `Paint Effects > Save Brush Preset`. This is the menu item you use to save the template brush as a preset brush.
- 2** Type the name `blueFern` in the Label box as well as the Overlay Label box. This name appears in icons on the Shelf or Visor after you save the brush.
- 3** For the Save Preset option, turn on `To Shelf`. This means you'll put the brush on the Shelf but not in the Visor.
- 4** Click `Grab Icon` and drag a selection box around a part of the image that is representative of the brush's result.

A swatch appears in the window for the selected region. Repeat this step until you are satisfied with the icon.

- 5** Click Save Brush Preset. An icon for the new preset brush appears on the Shelf.
- 6** To check that the blueFern brush works, select a different preset brush and paint on the canvas, then select the blueFern from the Shelf and paint on the canvas.
- 7** Clear the canvas and close the Save Brush Preset window.

Blending brushes

You can blend brushes. Before beginning, display the Visor, click gold.mel in the metal folder, and paint on the canvas so you know gold's effect. Do the same for grassOrnament.mel from the grasses folder.

To blend brushes

- 1** Click grassOrnament.mel in the grasses folder.
- 2** From the menu, select Paint Effects > Preset Blending > .
The Preset Blending options window appears.
The brush preset blending is toggled on and the options in this window set how much the template brush is influenced by the next preset brush you select. This affects only the subsequent painting, not the preset brushes in the Visor.
- 3** Change the Shading value to 80 and the Shape value to 0.
When you select the next brush (gold.mel), Maya uses 80% of its shading and 0% of its shape. Conversely, the stroke uses 20% of the grassOrnament.mel brush's shading and 100% of its shape.
- 4** To confirm the effect, select gold.mel (in the metal folder), then paint on the canvas.
- 5** Repeat the preceding steps, experimenting with different preset brushes, Shading, and Shape values. As a first try, blend flameCoarse.mel from the fire folder with the existing template brush. Set Shading to 60 and Shape to 30.
If the Brush Preset Blend window is open, each time you select a preset brush, its Shading and Shape values will be blended with the template brush.
- 6** Close the Brush Preset Blend window when you are done blending brushes.

11 | Painting

Lesson 1 > Smearing, blurring, and erasing paint

- 7 Do not clear the canvas. You'll use your existing strokes in the next steps.



Smearing, blurring, and erasing paint

Now you'll work with brush types that smear, blur, and erase paint.

To smear, blur, and erase paint

- 1 Select Brush > Reset Template Brush to select the default brush.
- 2 On the Brush menu, try the Smear, Blur, and Erase menu items and paint on the strokes already on the canvas. You can also change these settings using the Brush Type setting in the Paint Effects Brush Settings window (Brush > Edit Template Brush).
- 3 If you need to perform compositing work, you can view the image's alpha channel by clicking this button: .

White regions represent full opacity. Black represents full transparency.



- 4** If you turned on the alpha channel (Display > Alpha Channel), return to the display of full color by selecting Display > All Channels.
- 5** Clear the canvas and restore the canvas color to white (Canvas > Clear >).
- 6** To quit the canvas display and return to a scene view, select Panels > Perspective > persp (Hotkey 8).
- 7** In the Toolbox, click the Select Tool.
Clicking the Select Tool quits the Paint Effects Tool, and the mouse cursor displays as an arrow.
- 8** Select Paint Effects > Preset Blending to turn off Preset Blending before you proceed to the next lesson.

Beyond the lesson

In this lesson, you learned how to:

- Use Paint Effects to paint on the 2D canvas.
- Use the preset Paint Effects brushes from the Visor.
- Edit, blend, and save preset brushes for later use.

11 | Painting

Lesson 1 > Beyond the lesson

Painting on the 2D canvas is useful when you need to create a texture to be applied to a surface. For example, suppose you paint a repeating brick pattern on the canvas and save the canvas as an image file. You can create a material, for instance, a Blinn material, then apply the image file as a file texture to the color of the Blinn material. You can then apply the Blinn material to a 3D wall you've modeled, which creates the illusion of a brick wall.

Painting a 2D canvas is also useful for creating a background image for a scene. For instance, you might create lush foliage on the canvas, put it on a camera's image plane, then use it as the backdrop for animated jungle animals in the foreground.

Although not covered in this lesson, you can use a tablet and stylus to paint with pressure sensitivity. Pressure sensitivity allows you to more realistically simulate the effects of traditional drawing media (pens, pencils, markers, etc.)

Lesson 2 Painting in 3D using Paint Effects

The Paint Effects Tool goes beyond traditional paint software by allowing you to paint directly in 3D space, either on the ground plane or on an object's surface. When you use Paint Effects for 3D work, the paint strokes are three-dimensional and editable.



Image created by: Duncan Brinsmead

With Paint Effects, all of the hundreds of preset brushes found in the Visor under the Paint Effects tab (airbrushes, pens, markers, watercolors, plants, fire, metal, flowers, trees, and underwater etc.) can be used to create 3D objects in your scene. For example, you can use the preset plant brushes to paint a 3D tropical fern garden around a walking character in your scene.

You can animate brush strokes to create dynamic effects. For example, you can animate the ferns to shake in the wind or have them move when a character walks near them.

An electronic tablet with stylus is an ideal tool for painting with Paint Effects. With a real paint brush, pressing harder makes the brush wider and applies the paint more thickly. You can achieve the same effect with Paint Effects by specifying the effect of pressure on the stylus for each stroke and the threshold of response to pressure. You can map up to three attribute values to stylus pressure and edit them as you work.

When you use Paint Effects to paint 3D strokes, you can edit the brush and stroke attributes to create a variety of effects.

In this lesson, you begin to explore what is possible with painting in 3D using the Paint Effects Tool by learning how to:

- Paint directly in the 3D scene view.
- Choose brushes from the Visor and the Shelf and modify their brush attributes.

11 | Painting

Lesson 2 > Preparing for the lessons

- Paint in 3D using the Paint Effects panel.
- Differentiate between paint brushes and paint strokes.
- Make surfaces paintable so paint strokes can be applied to them.
- Select brush strokes and modify their attributes.
- View strokes in wireframe and rendered mode.
- Apply various effects to stroke attributes.

Preparing for the lessons

To ensure the lessons work as described, do these steps before beginning:

- 1 If you have not done so already, consider doing the lessons in Chapter 9, “Rendering.” Familiarity with Maya rendering concepts is important to understanding the lessons.
- 2 Select File > New Scene to create a new scene.
- 3 To use all available screen space, maximize the Maya window.
- 4 From a panel menu bar, select Panels > Layouts > Single Pane.
- 5 Select the Rendering menu set. Unless otherwise noted, the directions in this chapter assume the Rendering menu set is selected.
- 6 From the Shelf, select the Paint Effects tab to display the various preset brushes.

If the Paint Effects Shelf tab does not appear as part of the shelf set, see the Maya Help for Shelves. (For Linux users, any new shelves do not load by default.)

Regardless of your operating system, the Paint Effects preset brushes are accessible from the Visor panel. (From a view panel, select Panels > Panel > Visor.)

Brushes and strokes

Like a traditional paint program, Paint Effects allows you to use a brush and paint strokes. In Paint Effects, the brush and stroke have unique qualities and characteristics.

A *brush* contains the various attributes that define the appearance and behavior of the paint. The *template brush settings* define the initial settings for a brush.

When you drag the Paint Effects brush, you create a path for the brush called the *paint stroke*.

A stroke is a 3D curve (or collection of curves) with attributes that define how the paint is applied along the stroke path. You can paint strokes directly in the 3D scene or on objects.

When you select a brush preset from the shelf or from the Visor, that brush is copied to the template brush. Any changes you make to the template brush settings affect what the next stroke looks like, but they do not affect any previously painted strokes.

To select a Paint Effects preset brush from the Shelf

- 1 From the Toolbox panel layout shortcuts, select the Single Perspective View.
- 2 From the Shelf, select the Paint Effects tab to display the Paint Effects preset brushes.



- 3 From the Paint Effects shelf, select the Daisy Large Brush.

Daisy Large brush



In the scene view, the cursor changes to a red circle with a vertical line indicating it is set to paint a stroke. The circle indicates the width of the brush path. With some types of strokes, this path will appear as the width of the actual paint; with other stroke types, it indicates the width of the tube seeding path, for example, plants, trees, etc.

11 | Painting

Lesson 2 > Brushes and strokes

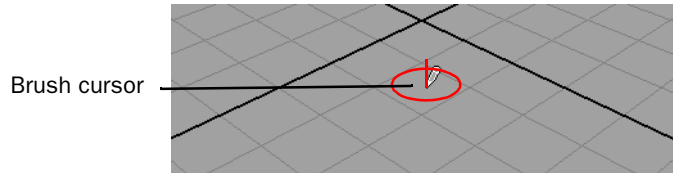

The settings of the preset brush you select are copied to the template brush. The template brush settings are used when a paint stroke is drawn. If you want to modify the brush presets before you begin to paint, you must edit the template brush after you've chosen the preset brush (Paint Effects > Template Brush Settings).

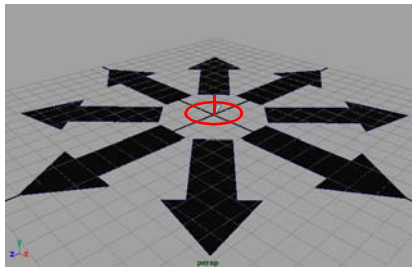

By default, the brush cursor moves along the ground plane. The ground plane lies in the X, Z dimension. This is the default behavior for the brush cursor. If you draw a paint stroke, it is applied to the ground plane (X, Z).

To paint 3D strokes in the scene view

1 With the Daisy Brush selected, draw one short paint stroke on the ground plane using one of the following methods:

- Drag the stylus across the tablet while exerting slight pressure on the stylus as you move it.
- Drag the mouse while pressing the left mouse button.

One or more wireframe daisy stalks appear in the scene view along the path of the paint stroke. When you paint a stroke in the scene view it initially appears as a wireframe. Paint is not applied to the stroke until it is rendered.

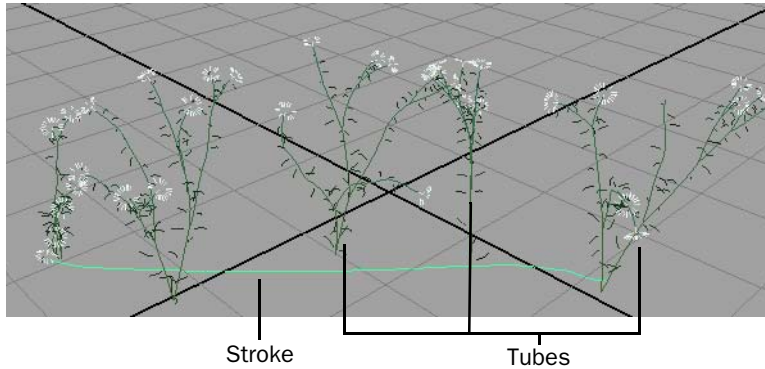

The stalks that extend out of the curve or stroke are called *tubes*. In Paint Effects, strokes are either simple strokes or strokes with tubes.

Because the stroke has a curve associated with it, you can move, scale, or rotate the stroke like other objects in the scene. You can edit the curve to modify the shape of the stroke path.

- 2** Dolly and tumble the scene to better view these strokes with tubes in 3D.
- 3** Select the Move Tool from the Toolbox.

A move manipulator icon appears at the X, Y, Z origin. (If the move manipulator does not appear, you can click on the stroke to reselect it with the Move Tool.)

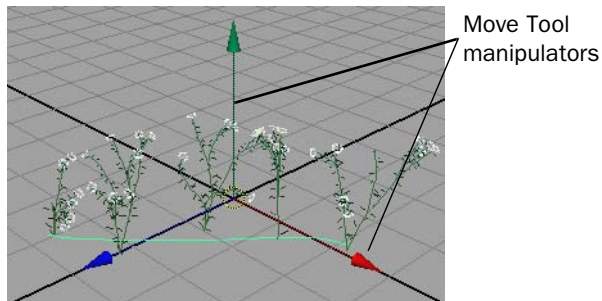

- 4** In the scene view, drag any of the Move Tool manipulator arrows to reposition the stroke.

11 | Painting

Lesson 2 > Brushes and strokes

Each time you paint a stroke, Paint Effects creates a new brush and stroke node and attaches them to the stroke that is created. You can modify these brush and stroke nodes once they've been created. To edit these brush or stroke attributes, you use the Attribute Editor.

To modify the attributes of an existing paint stroke

- 1 To view the Attribute Editor, click the Show/Hide icon on the Status Line.



The Attribute Editor displays.

- 2 In the scene view, select the paint stroke associated with the daisies. You can select a stroke by one of the following methods:
 - Select the curve associated with the stroke path.
 - Select the tubes associated with the stroke path.

The Attribute Editor updates to display the nodes associated with the selected daisy stroke. The various attributes for the stroke appear under different tabs. Each tab represents a node associated with a specific set of attributes.

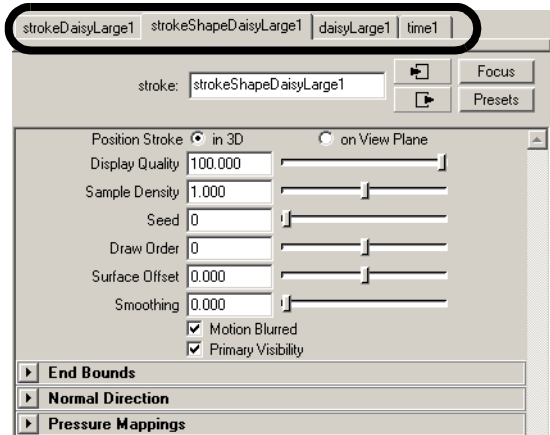

- 3 Click on the strokeDaisyLarge1 tab to see its attributes.
This tab contains information related to the transform node, because the most important attributes on this tab control the stroke's curve transformation.
- 4 Under Transform Attributes, set Rotate to be 0, 90, 0.

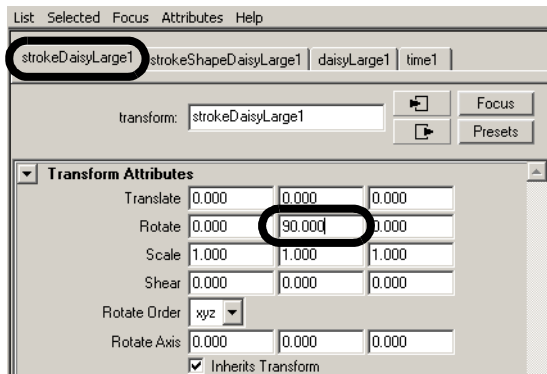

The stroke is rotated 90 degrees about the Y axis.

11 | Painting

Lesson 2 > Brushes and strokes

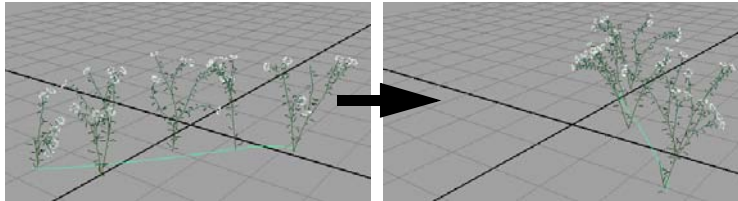

- 5 Click the strokeShapeDaisyLarge1 tab to see its attributes.
This tab is called the stroke attribute node because the attributes establish the paint stroke's properties when the stroke is first created.
- 6 Expand the End Bounds section by clicking the arrow to see the Min and Max Clip attributes.

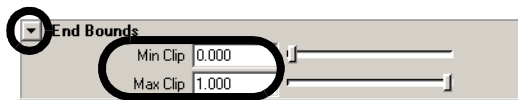

Min Clip specifies the start of the stroke along the path. Max Clip specifies the end of the stroke along the path.

- 7 Drag the Max Clip slider from its present value of 1.0 to a value of 0.1.
The stroke path is shortened.
Min and Max Clip can be animated to create the effect of the paint advancing along a path.

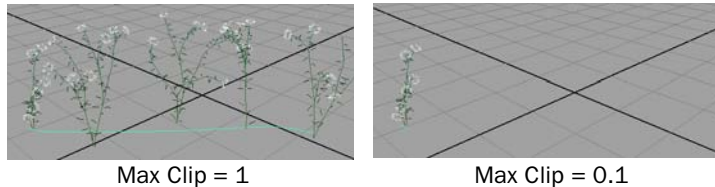

- 8 Drag the Max Clip slider back to its original value of 1.0.
- 9 Click the daisyLarge1 attribute tab to see its attributes.
This is the node that contains attributes related to the paint brush associated with the stroke.
- 10 Set the Global Scale attribute to 6.0.

The daisies scale larger along the stroke's path.

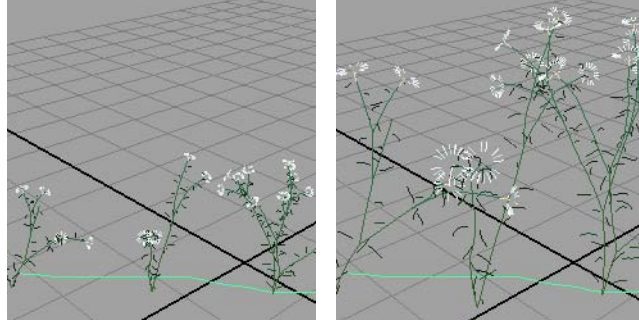

- 11 In the daisyLarge1 node, expand the Tubes attributes, then Behavior and Forces.

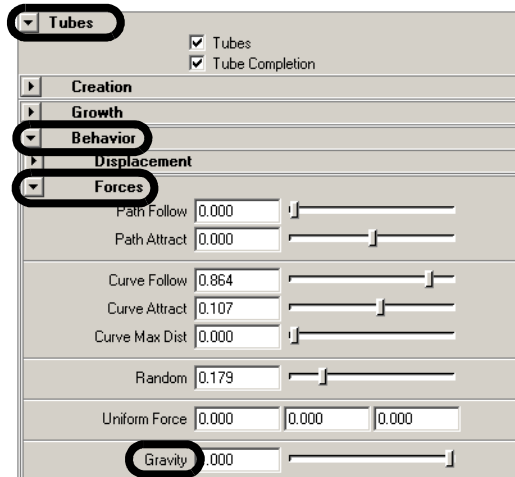

- 12 Drag the Gravity slider to the right so that the value of gravity increases to a value of 1.0.

The daisies lay on the ground plane, as if wilting, with the increased gravity.

11 | Painting

Lesson 2 > Rendering Paint Effects strokes

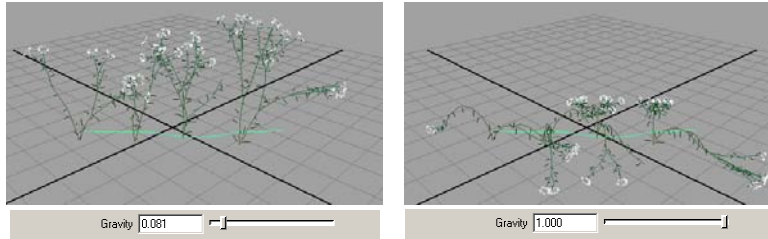

Drag the Gravity slider back to its original position approximately so that the stalks appear upright.

The last tab in the Attribute Editor is the time node. The time node is used for animation and dynamics. You do not use this node in this lesson.

Rendering Paint Effects strokes

The paint strokes display in wireframe mode when you paint in the scene view. Working in wireframe mode is very efficient in terms of interactive performance but you don't see how the paint actually appears. To view the paint strokes in a rendered mode you can either:

- Render the scene view using the software renderer.
- Switch to painting in the scene painting view using the Paint Effects panel.

To render the paint strokes in the scene view

- 1 Dolly or tumble the scene so the view of the daisies appears roughly similar to the image below.

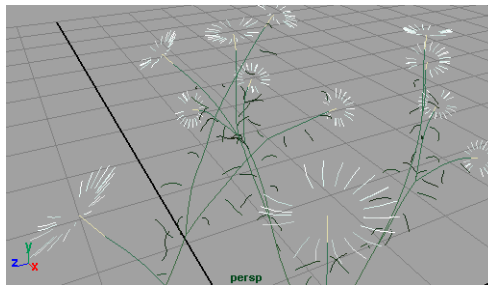

- 2 From the Status Line, click the Render Current Frame button.



The Render View window opens, renders the image, and then displays it.



The daisies may initially appear a bit dark in the image.

The Maya renderer creates a temporary light with a default brightness level in order to render the image when no lights are present in the scene. This ensures that you don't produce an image that is totally black; however it may not produce the correct illumination for your scene. If you want to obtain more control over the illumination of the daisies, you can create a light for the scene and adjust its brightness.

- 3 From the main menu, select Create > Lights > Directional Light.
A directional light is created at the X,Y, Z origin of the scene.

11 | Painting

Lesson 2 > Rendering Paint Effects strokes

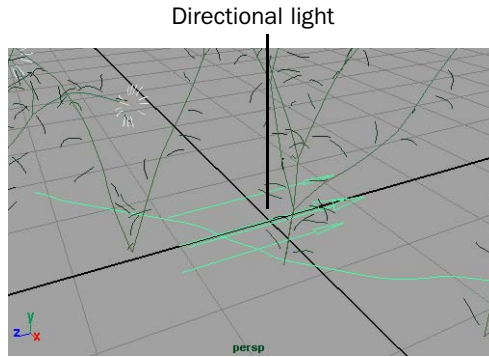

The Attribute Editor updates to display the attributes for the active directional light.

- 4 In the Attribute Editor, set the Intensity for the directional light to be 1.5.
- 5 From the Status Line, click the Render Current Frame button to render the scene again.

The image renders and the Render View window image is refreshed.

The daisies appear brighter in this version of the rendered image.

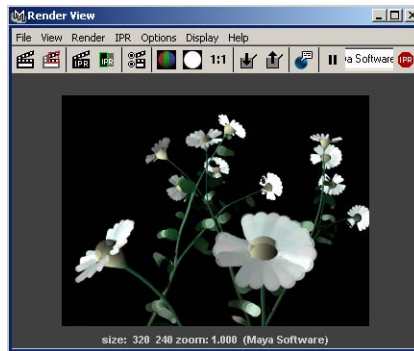

- 6 Close the Render View window.

Sometimes you may want to view your painted strokes as you paint. To do this, you can paint in the Paint Effects panel view and use the scene painting view mode.

To display rendered paint strokes as you paint

- 1 Press 8 to switch to the Paint Effects panel.

Note If the 2D Paint Canvas appears instead (i.e.: panel appears white), select Paint > Paint Scene, from the panel menu.

The Paint Effects panel menu and toolbar displays as well as the scene painting view. This panel allows you to paint in scene painting view mode.

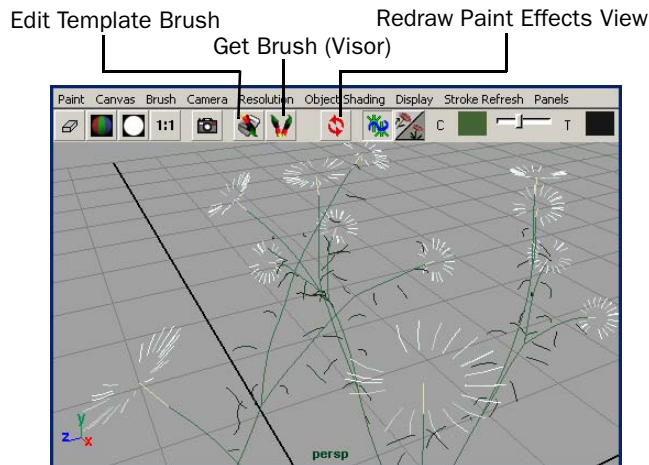

The scene painting view is a snapshot of the modeling view. In this view you can both paint and view your strokes in a rendered fashion to see what they will really look like as you work.

You can dolly, track, and tumble in the scene painting view. You can select objects by pressing the Ctrl key and clicking on them. If you want to move, or otherwise manipulate 3D objects in the scene view, you must exit the Paint Effects panel by pressing the 8 key again.

- 2 With the Daisy Brush selected, paint a stroke in the scene painting view.

11 | Painting

Lesson 2 > Rendering Paint Effects strokes

The new stroke displays in rendered mode. If you dolly or track the scene painting view, any rendered strokes will revert back to wireframe display until you refresh the rendered display.

- 3 To automatically update the paint strokes so they display in rendered mode, select Stroke Refresh > Rendered.

It will take a few moments for the rendering of all of the paint strokes to be calculated and then displayed.

Each time you adjust the camera view while working in scene painting mode with Refresh > Rendered turned on, the system will automatically update the rendering based on the new view.

Automatically refreshing the rendering can be time-consuming depending on the complexity of paint strokes in your scene. Alternatively, you can set the rendering to refresh only when you manually choose to do so.

- 4 From the Paint Effects panel menu, select Stroke Refresh > Off.

Now you must manually refresh the Paint Effects rendered view using the Redraw Paint Effects View button in order to see the paint strokes rendered.



- 5 Dolly the view to obtain a closer view of the daisies.
- 6 Manually refresh the rendering of the daisies by clicking the Redraw Paint Effects View button.

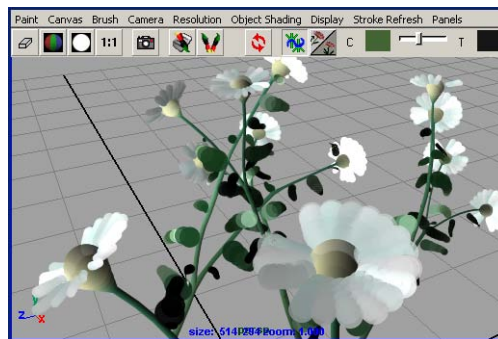

- 7 Exit the scene painting view mode by pressing the 8 key.

Paint Effects on 3D objects

With Paint Effects, you can paint 3D strokes directly on 3D objects in a Maya scene.

In this section, you create a surface for an underwater terrain and sculpt it to the desired form using the Sculpt Geometry tool. You use the underwater preset Paint Effects brushes found in the Visor to begin the underwater scene.

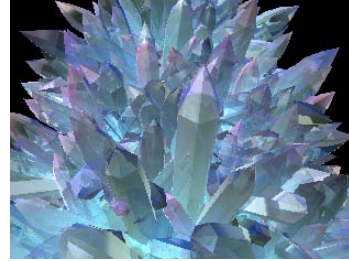

Image created by: Mark Jamieson

Creating a surface to paint on

In Paint Effects, NURBS surfaces are the only surface type you can paint on. You will create a NURBS plane, and sculpt it to make its surface appear like an underwater terrain.



To create a surface terrain for the underwater scene

- 1 Select File > New Scene.
A new empty scene is created.
- 2 From the main menu, select Create > NURBS Primitives > Plane > .

11 | Painting

Lesson 2 > Creating a surface to paint on

The NURBS plane options window appears.

- 3 In the NURBS Plane Options window, select Edit > Reset settings and then set the following options:

- Width: 15
- Length: 15
- U Patches: 10
- V Patches: 10

- 4 In the NURBS Plane Options window, click Create.

Maya creates a plane primitive and positions it at the origin. The plane is 15 units by 15 units in dimension with 10 subdivisions along each side.

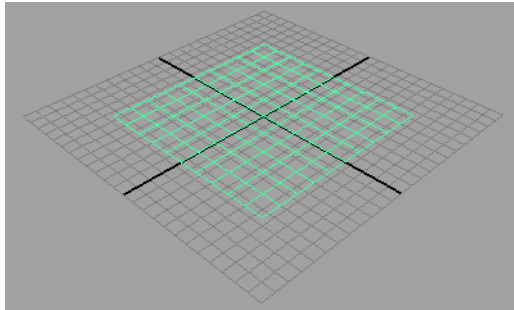

This surface will become the seabed terrain for your scene.

To sculpt a terrain using the Sculpt Geometry Tool

- 1 On the Status line, select Modeling from the drop-down menu.
The Main Menu changes to display Modeling menu set.
- 2 Select the plane surface.
- 3 From the Main menu, select Edit NURBS > Sculpt Geometry Tool.
The cursor display changes to the brush cursor for the Sculpt Geometry tool.

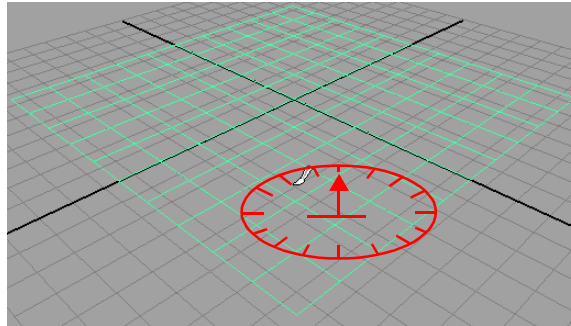

- 4 On the Status Line, click the Show/Hide Tool Settings button to display the tool editor for the Sculpt Geometry tool.

Show/Hide Tool Setting:

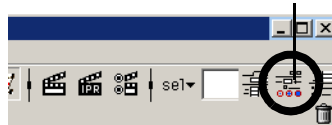

- 5 In the Sculpt Geometry Tool settings window Brush section, set the Radius (U) to 2. and set the sculpt Operation to Pull.

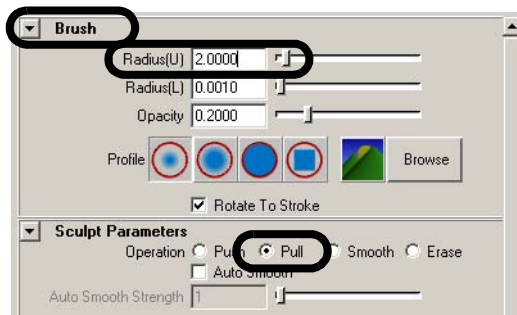

- 6 Drag the cursor along the back right edge of the plane to pull it upwards as shown.

11 | Painting

Lesson 2 > Creating a surface to paint on

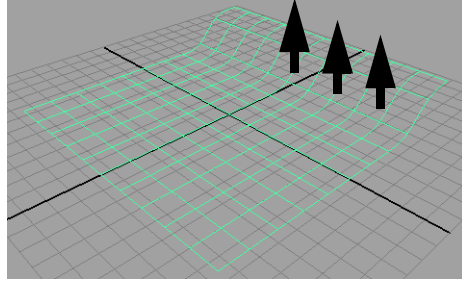

- 7** Drag the cursor along the back left edge of the plane to pull it upwards.
- 8** Dolly and track the view as required so you can easily view the areas you need to sculpt.
- 9** Sculpt along the front and middle of the plane to make some bumpy areas.
- 10** Repeat steps 7 through 10 until you have your 3D terrain looking roughly as shown in the image below.

Tip

If you want to undo a particular sculpt operation, click Ctrl + z to undo the sculpt stroke. You can click Ctrl + z repeatedly to undo a number of sculpt operations.

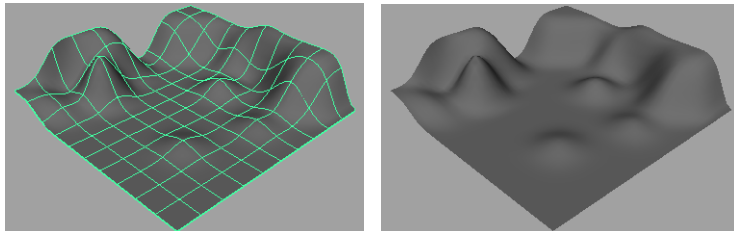

- 11** When you complete your terrain, return to the Rendering Menu set by selecting Rendering from the drop-down menu on the Status Line.
- 12** Hide the Sculpt Geometry Tool settings window before proceeding.

To select preset brushes from the Visor

- 1** From the main menu, select Paint Effects > Get Brush.
The Visor panel appears.
- 2** In the Visor, click the Paint Effects tab to display the various brush folders.
- 3** Scroll down the brush folders list to the underwater folder, and click it to view its contents.

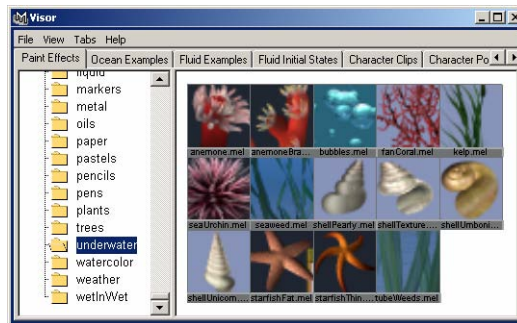
**Painting on objects**

To paint on a 3D object, you must first make the object paintable. When you paint directly on a paintable object, Paint Effects creates a curve on the surface along the stroke path and attaches the stroke and new brush to it.

If you make an object paintable and then try to paint on one that is not paintable, no stroke occurs. If you don't make any objects in your scene paintable, your strokes are placed on the ground plane.

To paint on a 3D object

- 1** With the terrain surface selected, select Paint Effects > Make Paintable.
- 2** From the Visor, select the brush named kelp.mel.
- 3** Paint a short stroke onto your 3D terrain surface.

11 | Painting

Lesson 2 > Using turbulence with brush stroke tubes

When you paint directly on a paintable object, Paint Effects creates a curve on the surface along the stroke path and attaches the stroke and new brush to it. If you move the plane, the paint stroke moves with it.

- 4 Paint a few more kelp strands throughout the scene as shown.

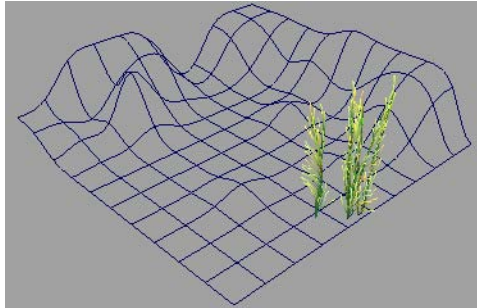

The kelp brush orients the tubes to point along the *normal* of the surface you paint on. In the ocean, kelp grows towards the surface of the water in a vertical manner. If you want your kelp to appear realistic, it should point vertically upwards. If you paint the kelp on an angled part of the surface, the kelp tube will not point in a vertical direction.

Tip

If you want to change the scale of the Paint Effects stroke to obtain larger plants or animals, press the b key and drag your stylus or mouse to the left or right to make the global scale for the current brush smaller or larger.

If you want to change the width of the brush stroke, to paint a narrower or wider tube path, for example, a wider swath of kelp plants, press the shift and b key and drag to the left or right.

Using turbulence with brush stroke tubes

In the ocean, kelp would react to the turbulence created by ocean currents. The tube attributes associated with many preset brushes have turbulence attributes turned on for interesting visual effects. Turbulence attributes can be increased from their default settings to make the kelp sway back and forth, providing additional realism when used in an animation.

To increase the turbulence on the kelp brush tube

- 1 In the scene view, select the kelp stroke.
- 2 Open the Attribute Editor, select the Kelp brush node tab, and expand the Tubes > Behavior > Turbulence section.

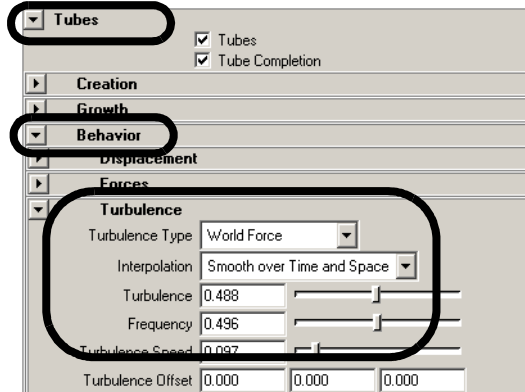

- 3 In the Turbulence section, set the options as follows:
 - Turbulence Type: World Force
 - Interpolation: Smooth over Time and Space
 - Turbulence: 0.5
 - Frequency: 0.5
- 4 Click the Play Forward button on the Animation Time Slider to see the turbulence effect on the kelp (You don't need to set specific keyframes). The kelp animates as if it were affected by ocean currents.
- 5 Press the Stop button to cancel the animation playback. You can adjust the turbulence settings while viewing the playback. If the frame range is too short, you can modify it to suit your needs.

Using additional preset brushes

- 1 From the Visor, select the brush named fanCoral.mel.

11 | Painting

Lesson 2 > Using additional preset brushes

- 2 Paint a few fan coral strokes in your scene near the back edges of the plane.

Tip

If you paint a stroke in your scene and want to delete it you can do so by one of the following methods:

- Press Ctrl + z to immediately undo the stroke.
- Click on the stroke to select it and then press the Delete key.
- Marquee-select a tube associated with the stroke and then press the Delete key.
- Marquee-select multiple tubes and strokes and then press the Delete key.

If you want to delete all the paint strokes in your scene you can select Edit > Delete All by Type > Strokes.

- 3 Paint additional strokes in your underwater scene using a few using the following brushes found in the underwater folder in the Visor:
 - sea urchins, starfish, seashells, and anemones

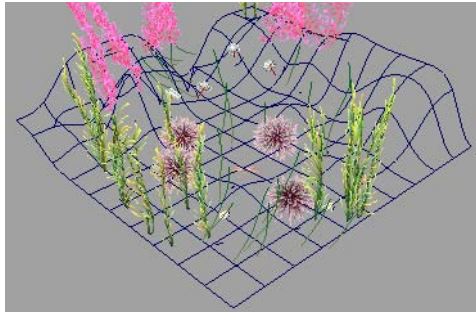

- 4 Dolly and track the scene for a closer view so it appears approximately as shown.

11 | Painting

Lesson 2 > Using additional preset brushes

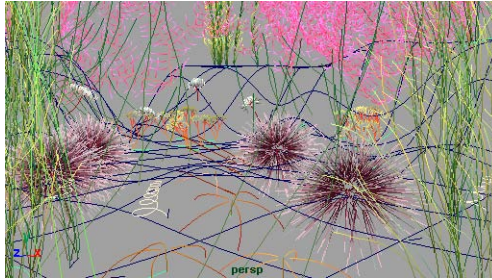

- 5 From the Status Line, click the Render Current Frame button.

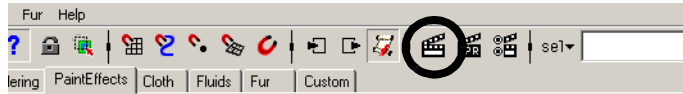

- 6 The renderer executes, renders the image, and then displays it in the Render View window.

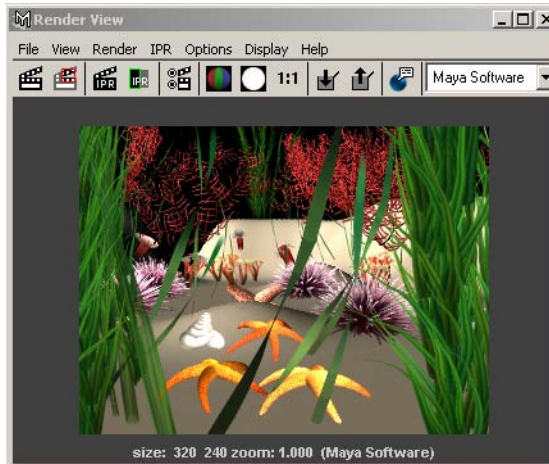

You can create a seabed texture for the plane primitive, a few rocks, and some animated fish swimming to complete your scene.

11 | Painting

Lesson 2 > Mesh brushes

You can spend additional time to further refine this scene, but this example gives you an idea of how a scene with various 3D props can be quickly established using Paint Effects and the various preset brushes found in the Visor.

Mesh brushes

Mesh brushes are a brush type that provide special features not available with other Paint Effect brush types. Mesh brushes render using polygonal triangles rather than brush stamps. As a result, mesh strokes can be more accurately texture-mapped for realistic results. They also appear more realistic compared to other brush types whether they are viewed close-up or from a distance.



Image produced using Tack Brush

The mesh brush stroke can also be converted to a polygonal surface in the Maya scene. Once the stroke is converted to polygons, the resulting polygons can be modified using any of the Maya polygonal modification tools and utilized like any other polygonal surface (animation, rendering, and so on)

In this section, you are introduced to mesh brushes and learn additional techniques related to the various brush and stroke attributes. You learn how to:

- Understand the structure of strokes with tubes.
- Modify a variety brush tube attributes.
- Convert the mesh brush stroke to polygons.
- Modify the converted mesh using construction history.
- Render the polygonal meshes.

To select a mesh brush preset from the Shelf

- 1** Select File > New Scene.
A new empty scene is created.
- 2** From the Toolbox panel layout shortcuts, select the Single Perspective View.

- 3 From the Shelf, select the Paint Effects tab to display the Paint Effects preset brushes.



- 4 From the Paint Effects shelf, select the Teapot Brush.

Teapot Brush icon



In the scene view, the cursor changes to a sphere icon indicating it is set to paint a stroke. The Teapot Brush is a mesh brush type.

- 5 In the scene view, drag your mouse or stylus along the ground plane to create one short stroke.
- 6 Dolly and tumble the view to see the wireframe version of the stroke.

The teapot stroke displays three wireframe tubes to represent the teapot. These tubes represent the body, spout, and handle for the teapot.

Paint Effects uses a plant or tree archetype to represent the various tube attributes. If you envision how a plant or tree has a trunk, out from which branches, leaves, flowers, and buds grow, you understand how each attribute is controlled in the attribute editor.

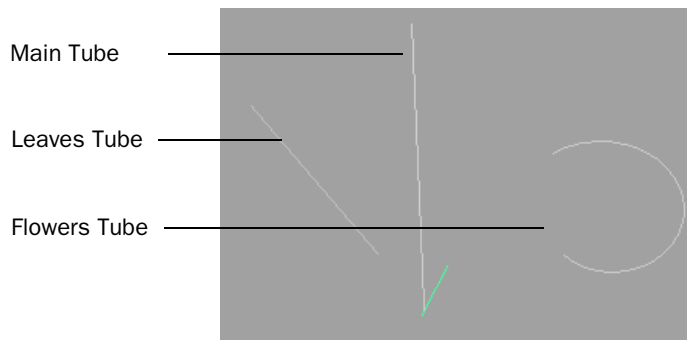

11 | Painting

Lesson 2 > Converting mesh strokes to polygons

The center vertical line represents the main tube, whose attributes are found in the Creation tab of the attribute editor. The diagonal and semicircular lines represent the Leaves and Flowers tube attributes for the spout and handle of the teapot.

To render the paint effects stroke

- 1 From the Status Line, click the Render Current Frame button.

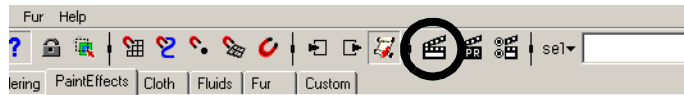

The renderer executes, renders the paint stroke, and then displays the image in a Render View window.



Mesh brush types are useful for representing hard surfaces compared to other brush types (the teapot is one example).

Converting mesh strokes to polygons

Mesh strokes can be converted to polygons. Converting the mesh stroke to polygons allows you to visualize any brush modifications you make in the Attribute Editor without having to render the stroke. It is possible to edit, animate, and render the converted polygon mesh the same way you would any other polygonal surface types.

To convert a mesh stroke to polygons

- 1** Press the q key (Hotkey) to choose the Select Tool.
The cursor changes to an arrow icon indicating the change to selection mode.
- 2** Select the teapot stroke, if it is not already selected.
- 3** Select Modify > Convert > Paint Effects to Polygons > .
- 4** In the Convert Paint Effects to Polygons Options window, ensure that the Hide Strokes option is set to On.

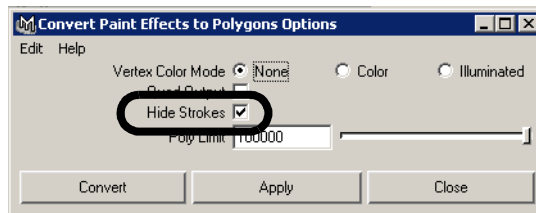

Setting the Hide Stroke option to On ensures that after the conversion, only the converted polygon mesh will be displayed.

- 5** In the Paint Effects to Polygons Options window, click Convert.
The mesh brush stroke is converted to a polygonal surface. A teapot model made of polygons results.

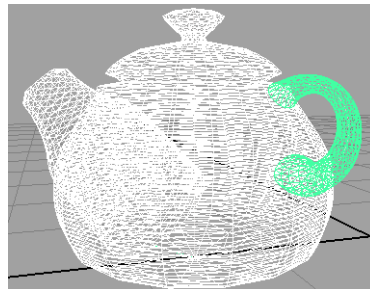

The original mesh brush stroke still remains but is now hidden.

- 6** Click anywhere in the scene view away from the teapot surface to de-select the teapot surface.

11 | Painting

Lesson 2 > Modifying a converted polygonal mesh

- 7 In the scene view, press 5 to smooth shade the display of the polygonal teapot.



Modifying a converted polygonal mesh

By default the original brush stroke is linked to the new polygonal surface via construction history. If you modify the original brush stroke attributes, the polygonal surface will update so long as the construction history link exists. This construction history link allows you to easily modify the polygonal mesh surfaces in a variety of ways. You modify the brush stroke attributes using the attribute editor.

To modify the teapot brush attributes

- 1 Marquee-select the polygonal teapot.
- 2 To view the Attribute Editor, click the Show/Hide button on the Status Line.

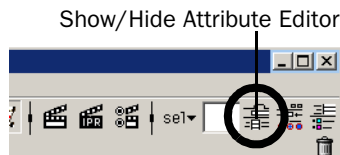

The Attribute Editor displays.

- 3 In the Attribute Editor, click on the teapot1 tab to display the brush attributes for the teapot stroke. (You may need to click the display arrow (Windows, Mac OS X) or select the tab from the pop-up list (Linux) in order to see the tab.)

Lesson 2 > Modifying a converted polygonal mesh

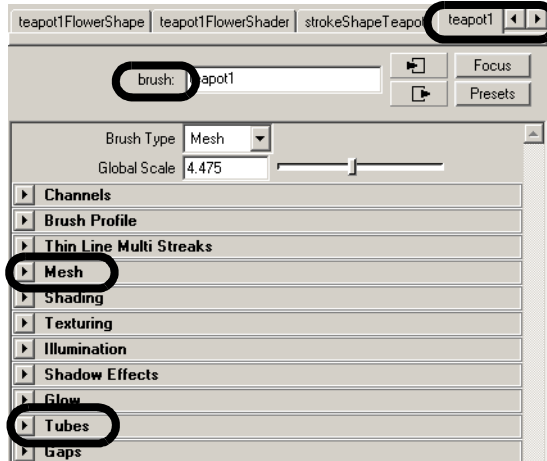

- 4 In the Attribute Editor, expand the Mesh attributes section to display its attributes.

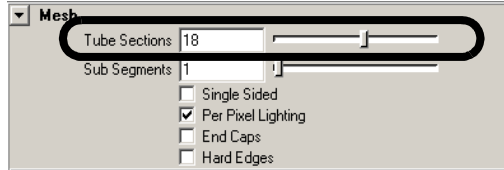

- 5 In the Mesh attributes, drag the Tubes Sections slider to the left to a value of 3.
The body, spout, and handle of the teapot update to display as 3 sided surfaces.

11 | Painting

Lesson 2 > Modifying a converted polygonal mesh



Tube Sections defines the number of sides around the width of the tubes in a mesh stroke. Changing the Tubes Sections gives a range of results depending on the brush type you choose.

- 6 Set the Tube Sections to a value of 18.
- 7 In the Attribute Editor, close the Mesh attributes, and then expand the Tubes attributes, then the Creation attributes.

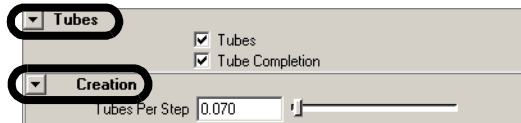

The Creation attributes control the main body of the teapot; the “trunk” or “stalk” of your paint effect mesh type.

- 8 Scroll down to the Width Scale attributes.
- 9 In the Width Scale attributes, drag an index point handle (as shown below) to change the profile shape of the teapot.

The profile of the teapot body is modified.

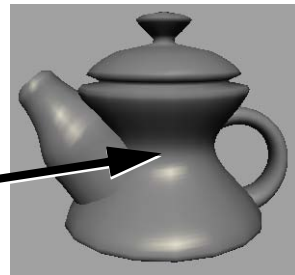
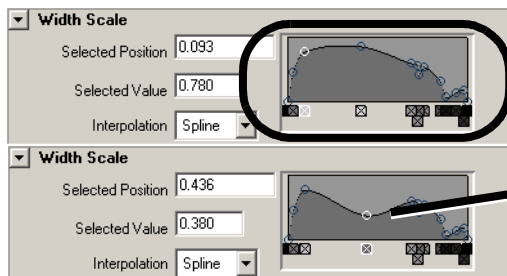

The Width Scale graph allows you to control the width of a tube by interpolating the shape between the index points. (If you look closely at the graph, you'll see the profile of the teapot laying on its side.)

- 10** Drag the index marker back to its original position.
- 11** Close the Creation attribute section in the Attribute Editor, and open the Growth attributes, followed by the Leaves attributes.

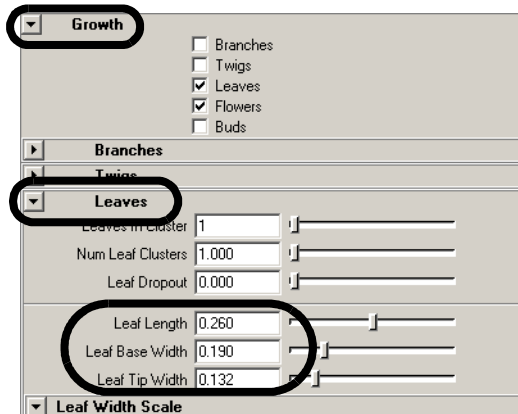

- 12** In the Leaves attributes, drag the sliders for the Leaves In Cluster, Leaf Length, Leaf Base Width, and Leaf Tip Width attributes to experiment with the spout of the teapot.



Leaves In Cluster = 6



Leaf Length = 0.4
 Leaf Base Width = 0.1
 Leaf Tip Width = 0.075

11 | Painting

Lesson 2 > Beyond the lesson

If you want to adjust the attributes of the teapot handle, you can edit the Flower attributes.

Using this converted poly mesh is one example of how the attributes of the paint stroke can be modified to affect the shape of another object through construction history.

If you delete the paint stroke, the construction history between the stroke and the polygonal teapot will be removed. If you then want to make further changes to the teapot, you must use the Edit Polygon tools.

To render the polygonal mesh teapot

- Render the teapot by clicking the Render Current Frame button on the Status Line.



Beyond the lesson

In this lesson with Paint Effects, you learned how to:

- Use preset brushes from the Shelf and the Visor.
- Paint directly in 3D space onto the ground plane or onto 3D objects.
- Select and move strokes in the scene.
- Edit brush and stroke attributes using the Attribute Editor.
- Render paint strokes.
- Use the Paint Effects Panel to paint fully-rendered paint strokes.

- Create a terrain to paint on using the Sculpt Geometry tool.
- Understand the structure and archetype for strokes with tubes.
- Use mesh brush types to paint hard-surface objects.
- Convert mesh brush strokes to polygonal surfaces.

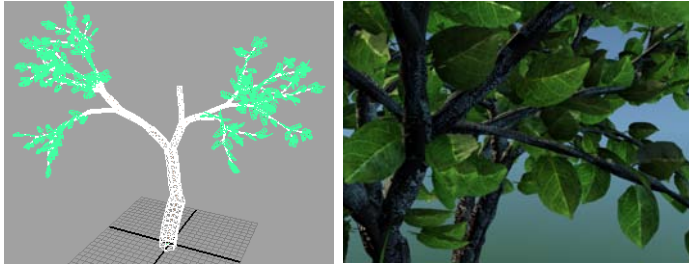

Image created by: Duncan Brinsmead

You can use Paint Effects to create natural or fantastic scenery, backdrops, and atmospheres. Mesh Brush types are particularly useful for creating polygonal trees that appear strikingly convincing, whether they are viewed close-up or from a distance.

Paint Effects has many other useful techniques not covered in this lesson. With Paint Effects you can:

- Modify strokes to share a single brush, make strokes glow, and animate the movement of strokes.
- Attach a brush to an existing curve (you don't need to paint a curve).
- Add spring-like behavior to strokes with tubes, or you can make the tubes react to dynamic forces such as wind.
- Create animated textures; for example, falling rain.
- Paint using a Thin Line brush type which allows you to render large numbers of fine tubes much more quickly than the Paint Brush type. This brush type is useful for painting hair.

11 | Painting

Lesson 3 > Open the scene for the lesson

Lesson 3 Painting textures on surfaces

The 3D Paint Tool allows you to paint textures directly onto a model's surface. In this lesson, you paint colors, patterns, and textures on a dinosaur model. In this lesson you learn how to:

- Prepare a surface model for painting.
- Paint on a surface using both Artisan and Paint Effects brushes.
- Use reflected paint strokes for symmetrical effects.
- Flood fill an entire 3D model with paint.
- Modify brush shapes and stamp settings.
- Paint a bump map texture directly on a surface.

Open the scene for the lesson

You will paint a dinosaur model we prepared for this lesson.

- 1 Do the steps outlined in "Preparing for the lessons" on page 506.
- 2 Open the scene named `3DPaint.mb`.

You can open the scene named `3DPaint.mb` from the *Maya Documentation, Lessons, and Extras* CD or from the drive where you copied the Getting Started with Maya data files

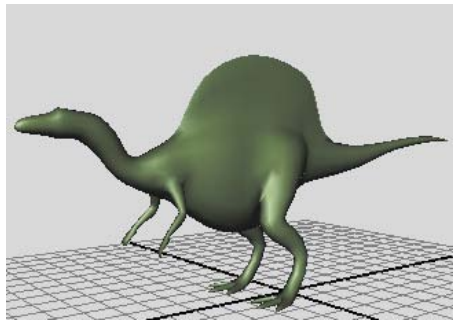

The scene contains a model named Dino. Although Dino is a polygonal model, the 3D Paint Tool works on all surface types: polygonal, NURBS, and subdivision surfaces.

To prepare the model for your use in this lesson, we assigned Dino a Blinn material named DinoSkin. You can paint a surface only if it has a material assigned to it. We also gave the Blinn material a green color. A color is optional, but it provides a base color for the texture you will paint.

Finally, we made other preparations to Dino so you can use the 3D Paint Tool successfully. You'll learn about the preparations in "Preparing UVs for painting" on page 568.

- 3** Save the scene in your default scenes directory (File > Save Scene As).

This lesson works best when you start with a saved scene. When you use the 3D Paint Tool, Maya automatically creates a directory to store the file texture that will be created from your painting. By saving the scene, you ensure that Maya can locate the directory and file texture that it creates automatically.

- 4** Select Display > UI Elements > Tool Settings. This displays a Tool Settings panel where the Channel Box is normally located. You will be working with this panel throughout the lesson.

Preparing for painting

- 1** Select Dino. You can paint only on selected objects. When you actually use the 3D Paint Tool, the wireframe of a selected object is not highlighted. You can check the Outliner to be sure the object is selected.
- 2** Select Texturing > 3D Paint Tool. The following warning appears on the Command Feedback line:

```
Warning: Some surfaces have no file texture assigned to the current attribute.
```

The 3D Paint Tool requires that the material assigned to your model has a file texture applied to it. Because there is no file texture yet assigned, the warning appears.

When you move the cursor over Dino, you see a circle-X icon that indicates you cannot paint on the model.

11 | Painting

Lesson 3 > Painting with an Artisan brush

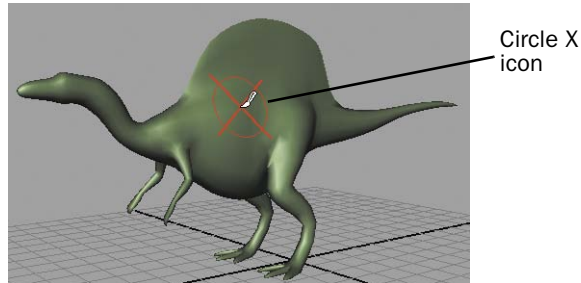

- 3** To make sure you have the default settings for the 3D Paint Tool, click Reset Tool at the top of the 3D Paint Tool settings panel.
- 4** In the File Textures section of the 3D Paint Tool settings panel, set the Attribute to Paint setting to Color, then click Assign/Edit Textures.

This step and the next two steps assign a texture to Dino. (Note that you can also paint over an existing texture that you assigned from Hypershade.)

- 5** Type 512 in the Size X box, which is the height of the new file texture in pixels.

By increasing the file texture size, you will see finer detail and resolution in a rendered image of your painting. The number 512 is twice the default size, 256. You could use a higher resolution, but sizes larger than 512 slow the interactive speed as you paint. Notice that Size Y automatically changes to 512. This is because Keep Aspect Ratio is turned on, ensuring that the proportions of the texture are maintained.

- 6** Click Assign/Edit Textures in the Assign/Edit File Textures window.

Maya creates a file texture and assigns it to the Color attribute of the DinoSkin material. At the end of the lesson you will learn about the name and location of the file texture that is created.

You are now ready to paint.

Painting with an Artisan brush

In the following steps, you paint various colors on the texture you just assigned. You also change the size of the brush strokes.

There are two types of brushes you can use. The default is the Artisan brush, which you'll use in the next steps. (Artisan refers to a group of painting tools in Maya that share common tool settings.) The other brush is based on the Paint Effects brushes; you'll use it later in the lesson.

To paint using an Artisan brush

- 1** If you have a tablet and pen, you can experiment with pressure sensitivity as you paint. Open the Stylus Pressure section and turn on Stylus Pressure. (You do not need to have a tablet and pen to complete the lesson.)

By default, when you paint with Artisan brushes, the pressure you apply to the pen affects the Opacity setting of the 3D Paint Tool. The harder you press, the more opaque the stroke.

- 2** In the Color section of the Tool Settings, click the box next to Color and select a color in the Color Chooser. Leave the Color Chooser open. You'll use it in the next few steps.

- 3** Paint a stroke by dragging on the model.

- 4** Select another color from the Color Chooser and paint over your first stroke.

The new color paints over the first color by default. Note that you can blend the colors by choosing a different Blend Mode setting, under the Paint Operations heading. You won't blend the colors in this lesson.

- 5** Move the brush onto Dino, hold down the b key and drag to the left to make the brush smaller. Drag until the number at the brush icon changes to about 0.5. You don't need to be precise.

Use this hotkey when you need to change the brush width. To make the brush wider, drag to the right. You can also change the width by changing the Radius (U) setting.

11 | Painting

Lesson 3 > Painting symmetrical strokes

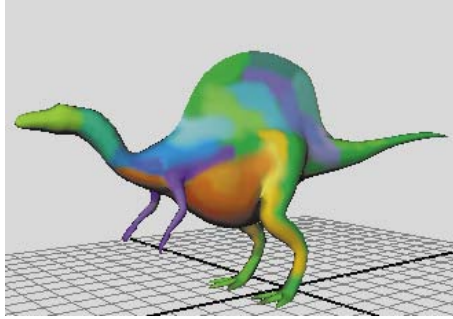

- 6** Experiment with different colors and brush sizes on Dino.
To undo a brush stroke, choose Edit > Undo. The number of strokes you can undo is specified by the Queue Size in the Undo category of the Preferences window (Window > Settings/Preferences > Preferences).
- 7** To remove paint, turn on Erase in the Paint Operations section and stroke the desired region.

Painting symmetrical strokes

You can reflect painted strokes along an invisible axis so that when you paint, the stroke is mirrored on the opposite side of the axis. Reflection is useful for creating symmetrical effects.

To paint using the reflection option

- 1** In the 3D Paint Tool settings panel, open the Stroke section and turn on Reflection and set the Reflection Axis to X.
Notice that there are now two brush outlines that run along an axis. The reflection axis is positioned around a point at the center of the object.

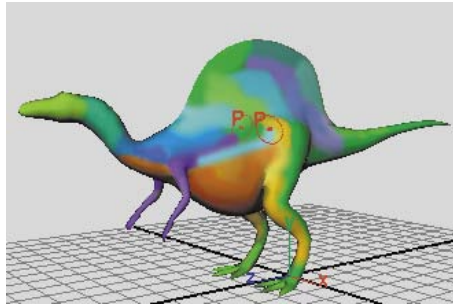

- 2** Paint on one side of Dino, such as one of the legs.
As you paint, the strokes are reflected along the axis and appear on the other side of Dino. Tumble to see the reflected stroke on Dino's other side.

Using Flood All to apply a single color

You can apply a single color to the entire texture without painting individual strokes.

To use Flood All to apply a single color

- 1** In the Flood settings of the 3D Paint Tool settings, click the Color box and select a pale green color from the Color Chooser.
- 2** Set the Flood setting to All and then click on the Flood Paint button.
The Flood Color overwrites all other painting you've done. You can also use Flood to erase painting.
- 3** In the Flood settings, click the Flood Erase button.
Maya eliminates all brush strokes, leaving you with the last saved version of the texture. (To save the texture, click the Save Textures button in the File Textures section.)

11 | Painting

Lesson 3 > Brush shapes

Brush shapes

You can paint with different brush shapes to produce paint strokes with hard edges, soft edges, or completely different patterns. You can choose from four standard Artisan brush shapes, plus 40 preset brush shapes.

To modify the shape of the brush

- 1 At the top of the 3D Paint Tool settings, click Reset Tool.

Reset Tool cancels the Reflection X and other settings from the previous steps. While painting, it's useful to reset the tool settings from time to time so previous settings do not interfere with your next strokes.

If you are using a tablet and pen, you'll need to turn on Stylus Pressure again to see the effect of your pressure as you paint.

- 2 Change the Color setting to dark red or another color that contrasts with the current green color.
- 3 In the Brush settings, click the following icon and paint a stroke:



By changing to the square brush shape, your brush stroke has a straight edge. Along with the shapes available from the icons, you can choose from many other unusual brush shapes that are based on image files. You'll do this in the next step. Before you do the next step, undo the brush stroke you just made so it doesn't distract from the next paint strokes.

- 4 In the 3D Paint Tool Brush settings, click the Browse button.
A browse window opens with a list of various image files. Each file represents a different brush shape.
- 5 Select `dapple.jpg` and click Open.
- 6 Click on Dino's hump and barely move the brush to create a single spot of paint.



Instead of a solid color, a pattern appears on Dino. The pattern is a result of using the `dapple.jpg` file for the brush shape. Undo the stroke.

- 7** Now drag the mouse over Dino to paint a single, continuous stroke.

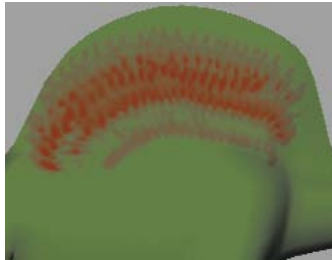

The brush shape pattern overlaps itself as you paint, resulting in a striped pattern. Undo the stroke.

- 8** To avoid the overlapping pattern of the prior step, increase the Stamp Spacing (in the Stroke section) to a value just under 1, such as 0.8. Paint on Dino with a continuous stroke and you'll see the brush pattern without it overlapping.

11 | Painting

Lesson 3 > Painting with a Paint Effects brush



The Stamp Spacing setting defines how paint is applied when you stroke the surface. If you set Stamp Spacing to 1, the edges of the brush shape pattern just touch each other. If you set the spacing to be greater than 1, there will be spaces between the brush shape pattern. If you set the spacing to be less than 1, the brush shape pattern will overlap.

Painting with a Paint Effects brush

You can use the 3D Paint Tool with the preset brushes available with Paint Effects. Paint Effects brushes include not only patterns but also images such as flowers, feathers, hair, and fire.

In the following steps you paint on Dino with a Paint Effects brush. Before you begin, consider first becoming familiar with the Paint Effects brushes, as taught in “Lesson 1 Painting in 2D using Paint Effects” on page 507.

To paint with a Paint Effects brush

- 1 In the Brush section of the 3D Paint Tool settings, click the following icon (Get Brush) to select from the preset Paint Effects brushes:



The Visor window opens. The Visor organizes the hundreds of Paint Effects brushes into category folders.

- 2 Scroll to the watercolor folder and click it.
To the right, swatch pictures of the Paint Effects brushes appear for this category.
- 3 Select the spatterLight.mel brush. (To see the names of the swatches, drag the pointer over them.)

Leave the Visor window open, but move it so you can see Dino again.

If you are using a tablet and stylus, you need to turn on Stylus Pressure again to see the effect of your pressure as you paint. Stylus Pressure is off because you changed from the Artisan brush to a Paint Effects brush.

For Paint Effects brushes, the pressure you apply to the pen affects three different settings. If you change the settings, it affects only the selected brush. The settings for each brush are separate from each other.

- 4 Paint on Dino.

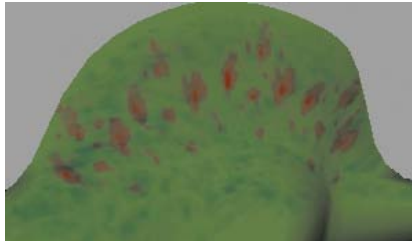

- 5 In the Brush section of the 3D Paint Tool settings, click the following icon (Edit Template Brush) to modify other brush settings: 

The Paint Effects Brush Settings window opens. Any changes you make to the settings in this window affect the display of your next stroke. As an example, you'll increase the brush's incandescence.

- 6 Open the Shading section in the Paint Effects Brush Settings window. For the Incandescence1 setting, move the slider to the right and stop midway.
- 7 Close the Paint Effects Brush Settings window and paint on Dino. Now the paint has an incandescent glow.

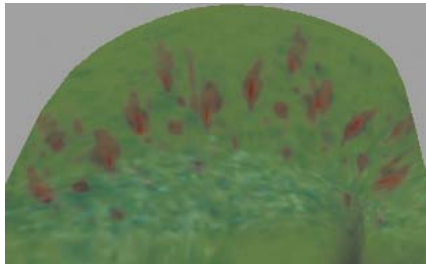

11 | Painting

Lesson 3 > Smearing and blurring

Smearing and blurring

In the next steps you'll smear and blur the paint on Dino. Smearing with a Paint Effects brush blends adjacent colors together along the stroke path. Blurring softens the edges of adjacent colors by averaging their color values.

To smear and blur with Paint Effects brushes

- 1 Move the Visor window back into view.
- 2 Click the wetInWet folder and then click the cleanWaterDrip.mel brush. Close the Visor window.

In the 3D Paint Tool settings, under Paint Operations settings, observe that the Paint Operation is now set to Paint Effects Smear. The brush you selected, cleanWaterDrip, has settings that turn on the Smear setting automatically for you.

- 3 Paint across the side of Dino. The paint smears and produces an effect similar to dripping wet paint.

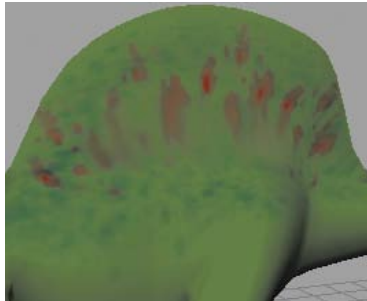

- 4 In the Paint Operations section of the 3D Paint Tool settings, select Paint Effects Blur.
This selects the default Paint Effects Blur brush.
- 5 Paint across the side of Dino to see the effect of Blur.

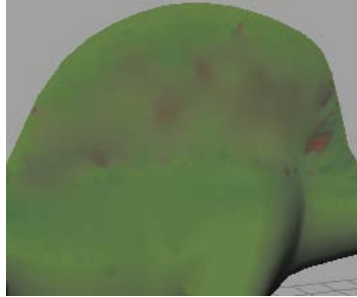

Painting a bump map texture

Next, you'll paint a bump pattern on Dino. In Maya, a bump texture creates the illusion of surface relief. It does this by perturbing the surface normals to make the surface appear bumpy. This is useful for making Dino's skin appear more "reptile-like".

To paint a bump map texture

- 1** In the 3D Paint Tool window, click Reset Tool to return to the default settings.
- 2** In the File Textures section, set the Attribute to Paint setting to Bump Map.
- 3** Click Assign/Edit Textures.

The Assign/Edit Textures window appears.

Earlier in the lesson, your painting affected only the Color attribute. To paint bumps, it's necessary to select a BumpMap as the new attribute you want to paint, and then assign a new texture for the bumps you'll create.

- 4** In the Assign/Edit Textures window, set both Size X and Size Y to 512 and then click Assign Textures.

Maya creates a file texture and applies it to the Bump Map attribute of the DinoSkin material.

In the scene view, Dino's color changes to white. Bump map textures are based on grayscale colors. By default, when you create a rendered image, bumps will appear in the areas of the surface where there is significant grayscale color contrast. For instance, if a region has black and white stripes, you'll see grooves there. Regions with little or no contrast display no bump.

11 | Painting

Lesson 3 > Painting a bump map texture

The bumps will not show in the scene view; you must create a rendered image in order to see them. The same is true when you paint certain other attributes, such as Transparency and Incandescence.

Before you paint bumps on Dino, you must set up the Maya panels so you can interactively see the results of your strokes in a rendered image.

- 5** Select Panels > Layouts > Two Panes Stacked.
- 6** In the bottom panel, select Panels > Panel > Render View.
Maya now displays the perspective view, the Render View, and the 3D Paint Tool settings. With this arrangement, you'll be able to see your strokes render as you paint.
- 7** In the perspective view, move the camera to a close-up view of Dino's side.
- 8** In the Render View, select IPR > IPR Render > persp. This renders an image of Dino in the Render View.
- 9** In the Render View, drag a selection box around Dino's midsection and hump.

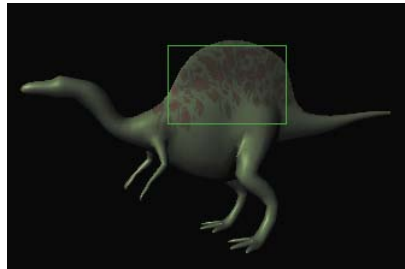

This region will update when you paint.

For the IPR renderer to render bumps as you paint, you must update the bump map texture after each stroke. You can set this to occur automatically.

- 10** In the File Textures section of the 3D Paint Tool settings, turn on Update on Stroke.
For a grooved bump effect, you need to change the brush shape.
- 11** In the Brush section of the 3D Paint Tool settings, click the Browse button.
- 12** Select the hatch.jpg brush and click Open.
- 13** Paint on Dino's side.

Notice the Render View updates with each stroke.

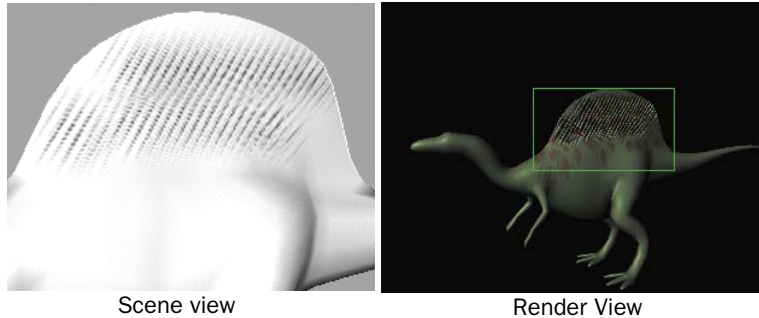

The bumps appear as grooves in Dino's surface because you painted contrasting black stripes on the white texture. In general, gray or black over a white background results in bumps that appear indented.

If you wanted bumps that appear raised on the surface, you could start with a black background and paint gray or white over it. For example, you could flood the texture with a black Flood Color, then paint white or gray strokes rather than the default black.

Greater contrast between the background color and the color you paint results in deeper-looking bumps. Less contrast results in more subtle bumps. In the previous step, you painted using a black color, resulting in prominent bumps. If you change the Color setting to a light gray and paint on the white background, only subtle bumps will appear.

This concludes the lesson.

- 14** Before doing other lessons, restore the Channel Box in the Maya window.
- 15** Select Display > UI Elements > Channel Box/Layer Editor.

Beyond the lesson

In this lesson you were introduced to a few basic techniques related to the 3D Paint Tool. You learned how to:

- Paint textures directly onto surfaces using the 3D Paint Tool.
- Paint symmetrically onto surfaces.

11 | Painting

Lesson 3 > Beyond the lesson

- Paint grey scale attributes to create bump texture effects.

There are several other capabilities in the Paint Operations section, such as the Clone option for Artisan brushes. With the Clone option, you can duplicate the color and pattern from an area of the texture and then paint that pattern elsewhere on the texture. For details on these options and other 3D Paint Tool techniques, refer to the Maya Help.

Location of 3D Paint Tool file textures

If you need to move or rename a file texture that Maya creates from your painting, look in the 3dPaintTextures directory under the current project directory. If you paint an existing file texture that you created previously, for example, with a paint program, Maya creates a copy and stores it in the 3dPaintTextures directory.

Preparing UVs for painting

In this lesson you worked with a polygonal model that was specially prepared for painting in this lesson. To paint successfully on a polygonal or subdivision surface, you must set up the surface UVs beforehand. UVs are points positioned around the surface like vertices. They control how Maya stretches a texture around a surface. For polygons and subdivision surfaces, you must arrange the UVs so that textures—including the ones you paint with the 3D Paint Tool—look correct when applied to the surface material. (The UVs on NURBS surfaces are automatically arranged for you, so you do not have to change them.)

You view and edit UVs using the UV Texture Editor (Window menu). You can obtain an introduction to UVs and the UV Texture Editor by completing the UV Texture Mapping lesson in this book. You can also learn more about UVs in the Maya Help by referring to the sections on Polygonal and Subdivisions surfaces.

If you already have experience with editing UVs, remember these two requirements for 3D painting:

- UVs must not overlap.
- UVs must fit with the 0 to 1 texture coordinates.

This illustration shows the UV Texture Editor with the UVs for the Dino model used in this lesson. These UVs meet the above two requirements. Notice that the UVs form several meshes; they do not need to be one solid mesh.

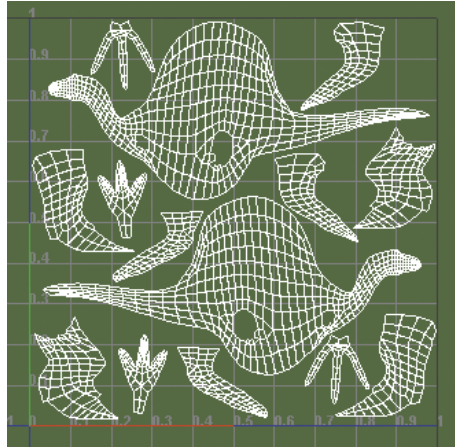

Painting in Screen Projection mode

When you paint on a model, the brush follows the contours of the surface. This typically produces the most desirable results. However, this default behavior leads to uneven paint application in some situations. A common example is along the line where two surfaces join together. It can also occur if the UVs are not arranged correctly, as described previously.

The solution to these situations is to turn on Screen Projection in the 3D Paint Tool settings. Screen Projection applies paint as if you are projecting cinematic film onto a screen. Paint appears where the projection strikes the surface.

The following figure shows an example of this situation with a Paint Effects brush.



Uneven paint stroke with Screen Projection off



Screen Projection on

11 | Painting

Lesson 3 > Beyond the lesson

12 Expressions

Expressions are program-like instructions you create to control keyable attributes over time. Expressions can be comprised of mathematical equations, conditional statements, or MEL™ commands.

Expressions offer an alternative to difficult keyframing tasks similar to Set Driven Key. With Set Driven Key, attribute relationships can be set up and are defined using animation curves. Unlike Set Driven Key, an expression does not use an animation curve to define the animation of the attribute but calculates the attribute values over time from the formula defined in the expression.

Although you can create an expression to animate attributes for any purpose, they're ideal for attributes that you want to change incrementally, randomly, or rhythmically over time.

It is possible to create custom attributes for objects and control them in conjunction with expressions. It is not possible to mix expressions with other animation techniques for the same attribute on an object (keyframing, path animation, set driven key).

In this example, an expression links the rotate attribute of the cylinder to the cone

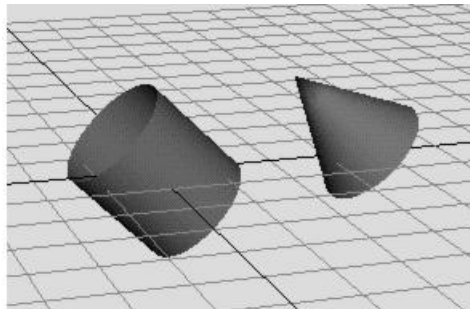

This chapter contains the following lessons:

- “Lesson 1 Creating a simple expression” on page 573
- “Lesson 2 Conditional expressions” on page 582
- “Lesson 3 Controlling particle attributes” on page 594

12 | Expressions

> Preparing for the lessons

Preparing for the lessons

To ensure the lessons work as described, do these steps before beginning:

- 1** Select File > New Scene to create a new scene.
- 2** Select Window > Settings/Preferences > Preferences. Click the Settings category and set the Time option to Film (24 fps) so your animation plays at the default rate of 24 frames per second. Click the Timeline category and enter 0 and 300 for the Playback Start/End values. (Press the Enter (Windows and Linux) or Return (Mac OS X) as necessary.) Set the Playback Speed to Play every frame. Click the Save button in the Preferences window.

At this playback speed and frame range, the animation results of the expressions you'll create in the lessons will be easier to examine and understand.

- 3** With the pointer in the perspective view, press 5 (for Shading > Smooth Shade All). It's easier to see the expression effects on shaded objects than wireframe objects in the following lessons.

Lesson 1 Creating a simple expression

This lesson introduces you to some basic concepts regarding the creation and editing of expressions. You learn how to:

- Use the expression editor to create and edit expressions.
- Control both single and multiple attributes of objects in your scene.

Creating expressions to control a single attribute

In the following steps, you create a default sphere and write an expression to increase its Scale Y attribute as the animation time increases during playback.

To create an expression

- 1** Make sure you've done the steps in "Preparing for the lessons" on page 572.
- 2** Create a NURBS or polygonal sphere with an X scale, Y scale, and Z scale of 1. Rename the sphere `Ball`. (Upper and lower case text is important)

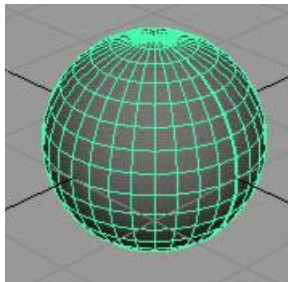

- 3** With `Ball` selected, choose `Window > Animation Editors > Expression Editor`.
- 4** In the Expression Name box, you can optionally enter an expression name, for instance, `ScaleBallHeight`.

If you write several expressions in the same scene, giving each a name might make it easier to find the desired expression if you decide to alter it later. If you don't provide a name, the expression receives a default name, for instance, `expression1`.

12 | Expressions

Lesson 1 > Creating expressions to control a single attribute

Note that the Attributes list displays Ball's keyable, unlocked attributes—the attributes you'll most likely want to animate with an expression. Use the scroll bar to see the entire list.

- 5 Enter this expression in the expression text area:

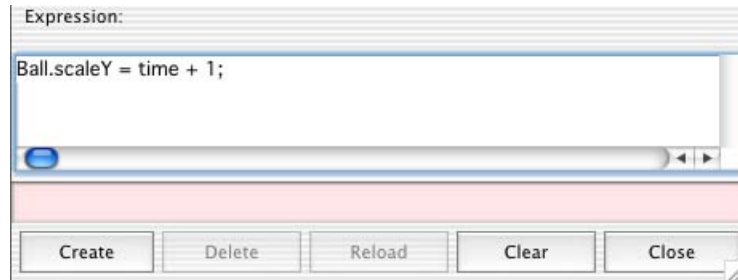

Type all characters exactly as shown above. Entries are case sensitive. The semicolon (;) signifies the end of the expression statement. End each statement in an expression with a semicolon.

An error message appears in the Script Editor and Command Line's response area if the expression has incorrect syntax or typing mistakes.

- 6 Click Create to create the expression.

Creating the expression checks it for syntax errors and converts it to a form Maya can execute when you return to the start time or play the animation. Clicking this button also executes the expression for the current frame.

The expression sets Ball's `scaleY` attribute to the value of `time + 1`. `Ball.scaleY` is the full name of the attribute. A period separates the name of the object and attribute. Note that you must spell the object and attribute with uppercase and lowercase letters as they appear in the Expression Editor's Objects and Attributes lists.

The word *time* is a commonly used predefined variable that updates as an animation plays. It contains the elapsed number of seconds from the first frame to the current frame. The value increases with the increasing frame number.

At the default animation playback rate of 24 frames per second, *time* has these values (rounded to four decimal places):

Frame	Time (secs)
0	0
1	0.0417
2	0.0833
3	0.125
24	1.0
240	10.0

You can find the time elapsed in the animation at any frame by calculating this formula with a desktop calculator:

$$time = \frac{frame}{rate}$$

For example, if the frame rate is 24 frames/second and the animation is at frame 1, the elapsed time is 1 divided by 24, or 0.0417. At frame 6, the elapsed time is 6 divided by 24, which equals 0.25. Note that if your frame rate was 30 frames/second the calculated values would be different.

- 7** Go to the start time and play the animation. Ball's scaleY attribute increases as the time increases:

Frame	Time (seconds)	Ball.scaleY (time + 1)
0	0	1
1	0.0417	1.0417
2	0.0833	1.0833

12 | Expressions

Lesson 1 > Creating expressions to control a single attribute

Frame	Time (seconds)	Ball.scaleY (time + 1)
3	0.125	1.125
24	1.0	2.0
240	10.0	11.0

Maya executes the expression each frame. This causes the object size to scale along its Y-axis, stretching its height during playback.

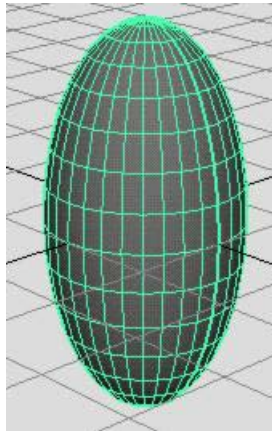

To see the value of Ball's scaleY attribute at any particular frame, select Ball, display the Channel Box, and stop the animation at the desired frame. The Channel Box updates its values after you stop the animation.

The scaling is smooth because the geometry stretches in synch with the small time increments of the animation playback.

- 8** Close the Expression Editor window.

Editing expressions

To edit an expression after you've created it and closed the window, you must know how to find the expression in the Expression Editor. The next steps show how to find and edit the expression. Specifically, you'll change the expression to alter how quickly the scaleY value changes.

To edit the expression

- 1 To display the Expression Editor again, select Window > Animation Editors > Expression Editor.
- 2 To find the expression, make sure the Ball is selected. In the Attributes list of the Expression Editor, select scaleY, the attribute controlled by the expression.

If you don't see the scaleY attribute, scroll through the Attributes list as necessary. You can also use the Select Filter menu option to customize how you search for your expressions within the Expression Editor.

The expression you created previously appears in the expression text field:

```
Ball.scaleY = time + 1;
```

- 3 Change the expression to this:

```
Ball.scaleY = time/5 + 1;
```

By dividing time by 5, you'll make the Y scaling increase one-fifth as fast as with the previous version of the expression.

Note that you can use the keyboard commands Ctrl-c (Windows and Linux) or Control-c (Mac OS X), Ctrl-x or Control-x, and Ctrl-v or Control-v to copy, cut, and paste text in the Expression Editor and elsewhere in Maya.

- 4 Click Edit to update the modified expression.
Clicking the Edit button does the same action as clicking the Create button. The Create button exists only for new expressions. The Edit button replaces the Create button when you display an existing expression.
- 5 Play the animation to see the results of the new expression.
The sphere scales at a slower rate than before.
- 6 Stop the animation and go to the start time.

12 | Expressions

Lesson 1 > Using expressions to control multiple attributes

- 7 At this point and in subsequent steps, save the scene if you think you'll want to examine it at a later date.

Using expressions to control multiple attributes

You can change the expression to control two or more attributes of Ball as in this example:

```
Ball.scaleX = time + 1;  
Ball.scaleY = time + 2;  
Ball.scaleZ = time + 5;
```

Maya scales the Ball at different rates for the X, Y, and Z dimensions.

Linking multiple attributes on the same object

You can change the expression to link the value of one attribute to another as in this example:

```
Ball.scaleX = time + 1;  
Ball.scaleY = Ball.scaleX;  
Ball.scaleZ = Ball.scaleX;
```

The second statement sets Ball.scaleY to the value of Ball.scaleX. Because you've set Ball.scaleX to the value of time + 1, Ball.scaleY also has the value of time + 1. You're linking one attribute's value to another. The third statement also sets Ball.scaleZ to the value of the attribute Ball.scaleX.

The advantage of this expression is that if you assign a different value to Ball.scaleX in the first statement, the second and third statements automatically receive the new value.

Controlling attributes in two objects

You can add an object to the scene and use the expression to control any of its attributes also. For example, suppose you added a default NURBS or polygonal cylinder named Drum to the scene. You could control attributes of Ball and Drum with the same expression as in this example:

```
Ball.scaleY = time/2 + 1;  
Drum.scaleX = time + 1;  
Drum.scaleY = time + 1;
```

You can link attributes in different objects—so a change in one attribute alters the behavior of the other. For example, you could cause Drum’s scaleY value to always equal two times Ball’s scaleY value as in this example:

```
Ball.scaleY = time + 1;  
Drum.scaleY = Ball.scaleY * 2;
```

If you decide to control attributes in two (or more) objects, you can select either object to write the expression. In fact, any object or node in a scene can be selected when you write an expression to control an object other than a particle object.

Alternatively, you can write two (or more) expressions, for instance, one that controls Ball.scaleY and one that controls Drum.scaleX and Drum.scaleY.

The advantage of creating separate expressions is that you’ll have two expression names, each presumably named after the object and attribute you’re controlling. Having two expression names makes it easier to find the expression that controls the desired attribute.

The advantage of using a single expression to control the attributes is that all statements are in a single expression. You don’t need to edit two expressions.

Beyond the lesson

In this lesson you learned how to:

- Create and edit simple expressions using the Expression Editor.

12 | Expressions

Lesson 1 > Beyond the lesson

- Use variables, for example time, to control the specific attributes within expressions.

When you write expressions, it is common to assign the built-in *time* variable to an attribute so the attribute value predictably increases as the animation plays. It's also useful to link an attribute's value to the value of another, such as setting the ball's scale Y and Z attributes to equal the scale X value.

- Control multiple attributes with a single expression.

Your expressions can control multiple attributes of the same object or of multiple objects. Alternatively, you can write a single expression for each attribute or object.

For more information on the various mathematical operators that are possible with expressions, refer to the Maya Help.

Behind the lesson

Although not shown in the lessons, you can decrease an attribute value during playback by subtracting time from some number. Example:

```
Ball.scaleY = 3 - time;
```

This decreases the value of Ball's scaleY attribute for the first three seconds of playback.

When you use the predefined time variable, note the animation start frame value. The lessons in this chapter use a start time of 0. In your work, you might create an animation with a start time of 1. With Maya's default frame rate of 24 frames per second, time is 0.0417 at frame 1.

Because of this small time offset from 0, the prior lesson would have required more steps and instructions to work with frame 1 as the start time. For instance, suppose you use following expression with the start time at 1.

```
Ball.scaleY = time + 1;
```

If you go to the start time, the expression sets the initial value of Ball's scaleY attribute to $\text{time} + 1$, which equals $0.0417 + 1$, or 1.0417. Because Ball's scaleY attribute was 1 when you created it, going to the start time sets scaleY to a value 0.0417 larger than its initial value.

12 | Expressions

Lesson 1 > Beyond the lesson

This discrepancy means the Ball scaleY is larger than its scaleX and scaleZ attributes in the first frame of the animation. Although the difference is minor in this example, other cases might be more significant.

To start your animation at frame 1 and get the same result as the example, you can subtract 0.0417 from the attribute:

```
Ball.scaleY = (time - 0.0417) + 1;
```

When you go to the start time, the expression sets Ball's scaleY value to $(0.0417 - 0.0417) + 1$. This equals 1, its original scaleY value.

12 | Expressions

Lesson 2 > Creating a conditional expression

Lesson 2 Conditional expressions

Conditional statements set one attribute or variable for an expression based on the condition of another attribute or variable. This means that when a particular defined condition exists for one attribute then another attribute is changed based on how the expression defines it to do so.

In this lesson you learn how to:

- Use conditional statements to control an expression.
- Refine the conditional statements using if and else statements.

Creating a conditional expression

In the following steps, you create a default sphere and write an expression to increase its Scale Y attribute based on the animation playback time. In the first two seconds of the animation time, Scale Y increases with the value of the time. At two seconds and thereafter, Scale Y no longer increases.

To create an expression using conditional statements

- 1 Make sure you've done the steps in "Preparing for the lessons" on page 572.
- 2 Create a NURBS or polygonal sphere at the origin with an X scale, Y scale, and Z scale of 1.
- 3 Name the sphere `Balloon`.
- 4 Go to the start time.
- 5 With `Balloon` selected, choose `Window > Animation Editors > Expression Editor`.
- 6 Enter this expression:

```
if (time < 2)
    Balloon.scaleY = time;
```

This expression is an *if* statement. The *if* keyword causes the expression to make a decision based on a comparison of two or more items. In this case, the expression compares the value of time to the value 2.

The expression checks whether the value of time is less than two seconds. If so, it does the assignment `Balloon.scaleY = time`. If time is not less than two seconds, the assignment doesn't occur.

Note When you compare the value of time to a number in an expression, Maya interprets time as seconds rather than milliseconds, minutes, or any other unit of time. In the example, Maya interprets 2 as two seconds.

Notice how the assignment `Balloon.scaleY = time` has been formatted so it appears indented under `if (time < 2)`. Maya ignores all indentation, extra spaces, and blank lines between statements. We used the indentation to make the expression easier to read. You could have also written the expression as follows:

```
if (time < 2) Balloon.scaleY = time;
```

This isn't as easy to read. Consistent, organized spacing is a good habit to develop. This book attempts to show examples of good spacing style whenever possible.

- 7** Click Create to compile the expression.

The ball flattens.

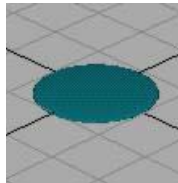

The expression executes when you click the Create button. Because the animation is at frame 0, animation time is 0. Because time is less than 2, Maya sets `Balloon.scaleY` equal to the value of time, which equals 0.

A `scaleY` value of 0 flattens the object in the Y dimension.

- 8** Playback the animation.

The flattened Balloon's scale increases along its Y-axis. It inflates as the animation plays.

12 | Expressions

Lesson 2 > Creating a conditional expression

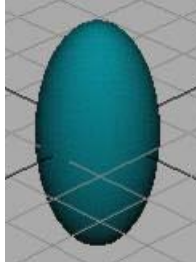

At 2 seconds and thereafter, Balloon no longer inflates.

When time equals 2 or more, the if condition is no longer true. The statement that follows it, `Balloon.scaleY = time`, no longer executes. The value of the `scaleY` attribute stays at the last value it had before time became 2, specifically, 1.9583.

Recall that this example uses a frame rate of 24 frames per second. The time and `Balloon.scaleY` have these values at various frames:

Frame	Time (seconds)	Balloon.scaleY (time)
0	0	0
1	0.0417	0.0417
2	0.0833	0.0833
3	0.125	0.125
24	1.0	1.0
47	1.96	1.9583
48	2.0	1.9583
49	2.04	1.9583

The if statement's condition, (time < 2), is a comparison. The condition must be surrounded by parentheses to isolate it from assignment that follows it.

The < in the condition is a relational operator. A relational operator tests how one value relates to another. In the example, the < tested whether time is less than 2.

Besides the < operator shown in this example, there are several other relational operators such as >, >=, ==, and so on. See the Maya Help for more details.

- 9 Stop the animation and go to the start time. Balloon flattens again because the scaleY attribute becomes 0 when you go to the start time. Time is 0, so scaleY is 0.

Other conditional statement options

You can make Balloon rise after it inflates by adding another if statement to the expression.

To add an if statement to the expression

- 1 Change the expression to this:

```
if (time < 2)
    Balloon.scaleY = time;
if (time >= 2)
    Balloon.translateY = time;
```

- 2 Click Edit to compile the expression.
- 3 Play the animation.

Balloon inflates for two seconds. After two seconds, Balloon stops inflating and its position skips from a Y-axis position of 0 to 2. You'll eliminate the motion skip in a later step.

The new if statement increases the translateY position of Balloon after the animation time rises above two seconds. The >= symbols mean greater than or equal to. Whenever time is greater than or equal to 2, the expression assigns Balloon's translateY the value of time. The translateY value therefore increases for the rest of your animation's playback range.

12 | Expressions

Lesson 2 > Other conditional statement options

Notice that a semicolon ends each statement for a particular condition. Forgetting a semicolon after each statement causes a syntax error, and the changes you've made to the expression won't take effect.

Note Always examine the Script Editor for error messages after you edit an expression and click the Create button. If you alter a previously successful expression and a syntax error occurs, Maya executes the previous successful expression when you play the animation. This might make you believe your changes took effect. Error messages are preceded by the text `// Error:`.

- 4 Stop the animation and go to the start time. Balloon flattens but doesn't return to the origin. (If Balloon has risen out of view, adjust your camera to see it.)

Balloon doesn't return to the origin because the expression doesn't assign Balloon a starting point for the beginning of the animation.

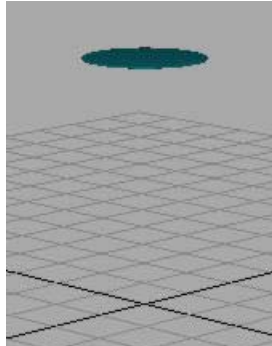

- 5 To make Balloon return to the origin, change the expression to this:

```
if (time < 2)
Balloon.translateY = 0;
if (time < 2)
Balloon.scaleY = time;
if (time >= 2)
```

```
Balloon.translateY = time;
```

The new first statement sets Balloon.translateY to 0 whenever time is less than 2.

Note that you can put the three statements in any order in this example. When Maya plays each frame, it executes each statement in the expression in the order listed. In this example, the statements work independently, so their order doesn't matter.

We put the statements in the order of time execution because it's easier to see the logic of the expression. If you ever need to change the expression, you'll be able to grasp the expression's actions more quickly.

- 6** Click Edit.
- 7** Stop the animation and go to the start time.

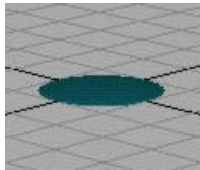

The flattened Balloon returns to its correct position at the origin.

- 8** Play the animation.
Balloon inflates for two seconds, then rises. As it rises, it jumps slightly higher at approximately frame 48.

Fixing a problem in an expression

As mentioned before, Balloon skips from Y-axis position 0 to 2 after two seconds of animation play. You can eliminate the skipping and make Balloon rise smoothly from the origin.

To fix the skipping in the animation

- 1** Stop the animation and go to the start time.
- 2** Change the expression as follows. (Changes are displayed in bold print.)

```
if (time < 2)
```

12 | Expressions

Lesson 2 > Using else statements

```
Balloon.translateY = 0;  
if (time < 2)  
Balloon.scaleY = time;  
if (time >= 2)  
Balloon.translateY = time - 2;
```

3 Click Edit.

Playback the animation. Balloon inflates for 2 seconds, then rises slowly and smoothly with time, from its position at the origin.

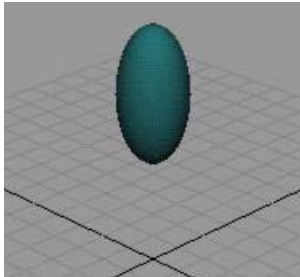

When time is greater than or equal to 2, the translateY position of Balloon becomes 2 minus 2, which is 0. As time increases beyond 2 seconds, the translateY position increases in the same increments that time increases.

4 Stop the animation and go to the start time.

Using else statements

The expression achieved the desired result, but with unnecessary complexity. You can use an if-else statement to make the statement more compact and easier to read.

1 Change the expression to this:

```
if (time < 2)  
Balloon.translateY = 0;
```



```

if (time < 2)
Balloon.scaleY = time;
else
Balloon.translateY = time - 2;

```

2 Click Edit.

3 Play the animation.

The animation plays back exactly as before.

This additional variation on the if conditional statement includes the *else* statement. It is used as an option when the if statement condition is not true. The *else* keyword sets `Balloon.translateY` to `time - 2` when `(time < 2)` is false. In English terms, the combination of the if and else statements means: If time is less than two seconds, set `Balloon.scaleY` to the value of time. Otherwise (when time is greater than or equal to two seconds), set `Balloon.translateY` to time minus two.

At any instant in the animation's playback, either `Balloon.scaleY = time` executes or `Balloon.translateY = time - 2` executes. Under no circumstances can they both execute. The *else* statement executes only when the if condition that precedes it is false.

The first if statement executes whenever time equals 0. It is unrelated to the if-else statements.

Using *else* statements instead of multiple if statements makes an expression simpler to read. If you use an if-else construction instead of a lengthy list of if statements, you'll also improve the execution speed of the expression. This improves your animation's playback and rendering speed.

Either expression is valid. If using the if-else construction seems confusing, stick with multiple if statements.

You can accomplish most expression animation tasks with several if statements strung after one another.

4 Stop the animation and go to the start time.

Simplifying expressions

You can simplify the expression to make it easier to read.

12 | Expressions

Lesson 2 > Editing expressions to refine an animation

- 1 Change the expression to this:

```
if (time < 2)
{
    Balloon.translateY = 0;
    Balloon.scaleY = time;
}
else
    Balloon.translateY = time - 2;
```

We removed the second if statement:

```
if (time < 2)
```

In its place, we enclosed the remaining statements with braces { and }. Maya evaluates both the statements between the braces if the condition (time < 2) is true. Setting Ball.translateY to 0 here instead of in a separate if statement makes the expression easier to read and comprehend. Reducing the statement in this way also makes it more efficient for Maya to process and easier to troubleshoot if you encounter a problem.

Note that you can put multiple statements between braces for an else statement, just as you do for an if statement.

- 2 Click Edit.
- 3 Play the animation.
The animation plays exactly as before with the new expression.
- 4 Stop the animation and go to the start time.

Editing expressions to refine an animation

You can further refine the animation by expanding Balloon more slowly.

To edit the expression to scale the balloon more slowly

- 1 Change the expression to this:

```
if (time < 2)
```

```
{  
Balloon.translateY = 0;  
Balloon.scaleY = time * 0.6;  
}  
else  
Balloon.translateY = time - 2;
```

(The asterisk (*) multiplies time by 0.6.)

- 2** Click Edit.
- 3** Play the animation.

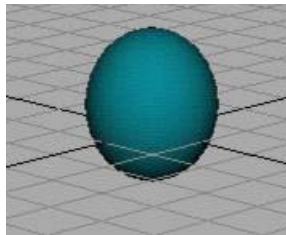

The `scaleY` attribute increases at 60% of the value of time, so Balloon expands slower during playback. (The number 0.6 equals 60%.) By the time Balloon starts to rise, it has expanded to the size of a typical balloon.

To know whether to multiply time by 0.6 or some other number, you need to experiment.

For example, you might multiply by various percentages such as 0.2, 0.5, 0.75, and finally 0.6. The 0.6 creates a life-like balloon shape at two seconds.

- 4** Stop the animation and go to the start time.

You can further refine Balloon's appearance by eliminating the flattened Balloon that appears at the origin when you go to the start time. You can also scale Balloon at different rates along each of its three axes.

12 | Expressions

Lesson 2 > Editing expressions to refine an animation

To edit the expression to change the balloon's initial scale

- 1 Change the expression to this:

```
if (time < 2)
{
    Balloon.translateY = 0;
    Balloon.scaleY = time * 0.6;
    Balloon.scaleX = time * 0.5;
    Balloon.scaleZ = time * 0.5;
}
else
    Balloon.translateY = time - 2;
```

- 2 Click Edit.

At frame 0, Balloon disappears from view because its scale attributes are 0. The scaleX, scaleY, and scaleZ attributes are 0 at frame 0 because time is 0. Any number multiplied by 0 is 0.

- 3 Play the animation.

As time increases, the value of Balloon's scale attributes increase.

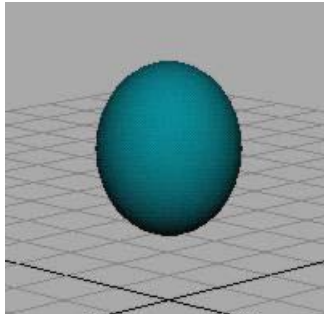

Because the expression sets `scaleX` and `scaleZ` to 50% of the value of `time`, these dimensions scale slower than `scaleY`, which is set to 60% of the value of `time`. Balloon scales faster in height than in width or depth. This is true for many real balloons.

- 4** Stop the animation and go to the start time.
- 5** Save the scene if you plan to examine it later.

Beyond the lesson

In this lesson you learned how to:

- Use conditional statements to control an expression.

You can accomplish many expression tasks with several `if` statements strung after one another. However, using `else` statements instead of multiple `if` statements makes an expression simpler to read.

If statements and *else* statements are two of the most common programming features available in expressions. If you're familiar with programming, you can write expressions with an extensive syntax similar to the C language.

For further information and related techniques, refer to the Maya Help.

12 | Expressions

Lesson 3 > Creating particle objects

Lesson 3 Controlling particle attributes

You can use an expression to control attributes of particle objects. Particle expressions can be more complex than other types of expressions. For example, you can write an expression to control all particles in an object the same way, or you can control each particle differently.

In this lesson you learn how to:

- create a particle object
- create a creation expression to set the initial color of the particles
- create a runtime expression to control the color during playback
- use a random function to randomize how the color changes
- control the timing of an expression

Creating particle objects

In the following steps, you'll create a particle object made of 100 randomly positioned particles displayed as tiny spheres. You'll also dynamically add an attribute to the particles. To color particles with an expression, Maya requires you to dynamically add the appropriate attribute.

To create a particle object

- 1** Make sure you've done the steps in "Preparing for the lessons" on page 572.
- 2** From the Dynamics menu set, select Particles > Particle Tool > .
- 3** In the Tool Settings window, click Reset Tool, and set the following options:
 - Particle Name: `Bubbles`
 - Number of Particles: `100`
 - Maximum Radius: `5`
 - Click in the scene view (roughly in the center) to create the 100-particle object.
- 4** From the Toolbox, select the Selection Tool so that particles become selected.

Lesson 3 > Using creation expressions to set a constant color

- 5 With Bubbles selected, display the Attribute Editor.
- 6 In the Attribute Editor, select the BubblesShape tab, and then open the Render Attributes section and set the following:
 - Particle Render Type: Spheres
 - Add Attributes For: Click the Current Render Type button.
 - Radius: 0.5

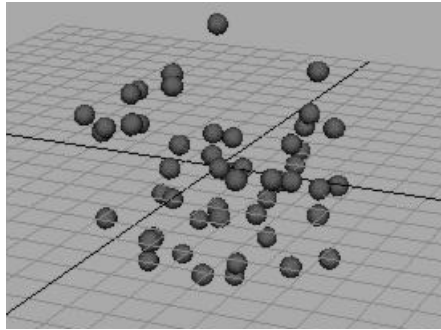

- 7 In the Add Dynamic Attributes section of the Attribute Editor, click the Color button. A window appears that prompts you to choose whether to add the attribute per object, per particle, or connected to a shader.
- 8 Turn on Add Per Particle Attribute, then click the Add Attribute button.
This adds an rgbPP attribute to the particle shape node for Bubbles. Because you're adding this attribute as a per particle attribute, you can give each particle a different color.

Using creation expressions to set a constant color

To set an attribute that doesn't change during the animation (the particle color), you'll use a *creation expression*. A creation expression executes when you go to the start time. It doesn't execute while the animation plays. (For emitted particles, a creation expression executes for a particular particle when it is emitted.)

12 | Expressions

Lesson 3 > Using creation expressions to set a constant color

To create a creation expression

- 1 In the Per Particle (Array) Attributes section of the Attribute Editor, right-click the rgbPP box and select Creation Expression from the pop-up menu. Note that the shape node of Bubbles (*BubblesShape*) is displayed in the Expression Editor.

When you use an expression to control particle attributes, make sure the selected object in the Expression Editor is a particle shape node, not the transform node of the particle object. If a particle object's transform node is selected, move the mouse pointer to the scene view and press the down arrow key to select the particle shape node.

- 2 Enter this expression and then click the Create button:

```
BubblesShape.rgbPP = <<1,0,0>>;
```

When you click the Create button in the Expression Editor, Maya checks the syntax of the expression. Assuming you made no typing errors, the expression executes once for each of the 100 particles.

The expression colors all particles in the object red. The double angle brackets << and >> enclose a vector that sets the red, green, and blue components of the rgbPP attribute to 1, 0, and 0. In the RGB color scheme, this gives the object a red color.

If the particles are uncolored, check that you've turned on Shading > Smooth Shade All. This shading mode is necessary for particles to show the color assigned in an expression.

- 3 Play the animation. The particles remain red.

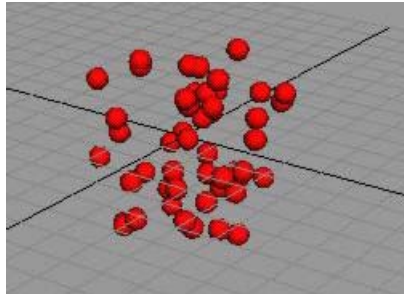

Using runtime expressions

There is one other type of expression you can create for a particle object (shape node)—a runtime expression. By default, a runtime expression executes each frame during playback. A runtime expression does not execute when you go to the start time (or at the time in which a particle is emitted).

You'll often create both types of expressions for a particle object—a creation expression that initializes an attribute value in the first frame, and a runtime expression that controls the attribute value in subsequent frames.

The following steps show how to create a runtime expression to change particle color during playback.

To create a runtime expression

1 In the Per Particle (Array) Attributes section of the Attribute Editor, right-click the `rgbPP` box and select Runtime Before Dynamics Expression from the pop-up menu.

2 Enter this runtime expression:

```
BubblesShape.rgbPP = sphrand(1);
```

3 Click the Create button to compile the expression.

4 Play the animation.

The particles flicker in random colors as the animation plays back. The runtime expression controls the `rgbPP` attribute during playback. Because `rgbPP` is a per particle attribute, the runtime expression executes for each particle in the object for each frame. For each particle, the expression assigns the `rgbPP` attribute the output from the execution of the *sphrand* function with an argument of `1`. The *sphrand* function is one of Maya's many built-in mathematical functions that are useful in expressions.

The *sphrand* function with an argument of `1` assigns each particle's `rgbPP` color a random vector. The vector represents a random point in a spherical region of radius `1`. The left, middle, and right `rgbPP` color components get a value no less than `-1` and no greater than `1`. (R, G, and B values less than `0` are treated as `0`—a black color).

12 | Expressions

Lesson 3 > Modifying runtime expressions

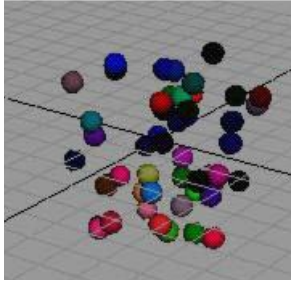

The `sphrand` function returns a different random vector each execution, so each particle receives a different random `rgbPP` value, and therefore, a different color. The color changes each frame.

5 Rewind and play the animation again.

The particles become red when you go to the start time, and random colors during playback.

Note You can use only one creation and one runtime expression per particle object (shape node) in your scene. To control multiple attributes of a single particle object, you must do so within one creation expression and one runtime expression. You can't create a separate expression for each attribute as you can for other types of objects. You therefore don't need to select an attribute from the Expression Editor's Attributes list.

Modifying runtime expressions

You might have trouble seeing the color of a particle in any instant because the color changes so quickly. You can slow the change of colors to create a flashing Christmas light effect. The following steps make the particles change colors every second of animation.

To adjust the timing of the change of color

1 Change the runtime expression to this:

```
if ((frame % 24) == 0)
  BubblesShape.rgbPP = sphrand(1);
```

This expression uses the modulus operator (%) to control when the `rgbPP` attribute of the particles receives a random color. The modulus operator returns the remainder after division. For example, 24 divided by 24 returns 0, but 25 divided by 24 returns 1. (Dividing 25 by 24 equals 1 with a remainder of 1.)

If the value of `frame` divided by 24 is equal to any number with a remainder of 0, the assignment to `BubblesShape.rgbPP` occurs. In other words, the assignment occurs when `frame` equals 24, 48, 72, and so on. At an animation rate of 24 frames/second, the assignment happens once each second.

The `==` symbols mean *is equal to*. In conditional statements, be careful to type `==` rather than `=`. The `=` symbol means *assign the value to*.

2 Rewind and play the animation again.

When you go to the start time, the particles turn red because the creation expression executes. When the animation plays, the particles receive a random color once each second.

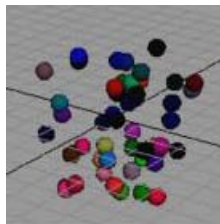

1 second

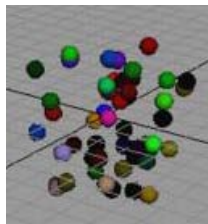

2 seconds

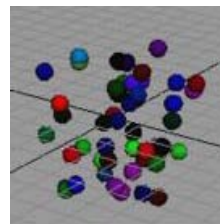

3 seconds

Note that you can change the beginning red color to random colors by changing the creation expression to this:

```
BubblesShape.rgbPP = sphrand(1);
```

This is the same expression as the runtime expression.

3 Save the scene if you plan to examine it later. This concludes the lesson.

12 | Expressions

Lesson 3 > Beyond the lesson

Beyond the lesson

In this lesson you learned how to:

- Control particles using creation and runtime expressions.
- Apply a random function to your expression.

For a particle object, you typically create two expressions—a creation expression that initializes an attribute value in the first frame, and a runtime expression that controls the attribute value in subsequent frames. (Creation and runtime expressions exist only for particle objects, not for other types of objects.)

This lesson described how to color stationary particles as a simple way to describe creation and runtime expressions. However, it's more typical to use particle expressions to:

- Create sophisticated particle motion and life span; for example, the movement and fading of exploding fireworks.
- Create complex colors for emitted particles, for example, rocket exhaust flames.
- Create complex colors and movement of particles following collision with geometry, for example, sparks resulting from fired bullets.

Creating such effects requires experience and experimentation. Expression writing can be as complex as computer programming. A detailed understanding of expression execution and syntax is essential. You also need to become familiar with the built-in mathematical functions such as the sphrand function introduced in this lesson.

For further information and related techniques, refer to the Maya Help.

13 MEL

MEL™ (Maya Embedded Language) is a powerful command and scripting language that gives you direct control over Maya's features, processes, and workflow.

Maya's user interface is built using MEL™ scripts and procedures. When you select menu items or otherwise use the interface, Maya performs the operations by internally running MEL™ commands. You can type the same MEL commands directly as a quick alternative to selecting menu items or doing other actions.

Although MEL is technically a scripting language, it contains features that are worthwhile and easy to learn even if you have no programming experience.

You can create custom buttons on the shelf so you can run the scripts you have created at the click of the mouse. In this way, you can organize MEL commands into reusable script files that let you:

- Automate tasks you might otherwise do more slowly or tediously with the user interface.
- Use additional Maya features.
- Create custom user interfaces to perform specialized workflows.
- Create new effects.

In this chapter you will be introduced to some of the basic concepts and techniques for working with MEL.

Preparing for the lesson

To ensure the lessons work as described, do these steps before beginning:

- 1** Create a new scene.
- 2** Use a computer that has an Internet connection and Web browser. Part of the lesson requires that you download material from our Web site at www.alias.com.

13 | MEL

Lesson 1 > Using MEL commands

Lesson 1 MEL basics

In this lesson, you learn how to:

- Use the Script Editor to view and enter MEL commands.
- Enter MEL commands in place of selecting menu items.
- Create a Shelf button to run a series of commands.
- Run and create scripts that execute a series of commands.

Using MEL commands

In the first part of the lesson, you'll learn how to type a MEL command as a substitute for selecting a menu item.

To use the script editor

- 1 Select Window > General Editors > Script Editor.

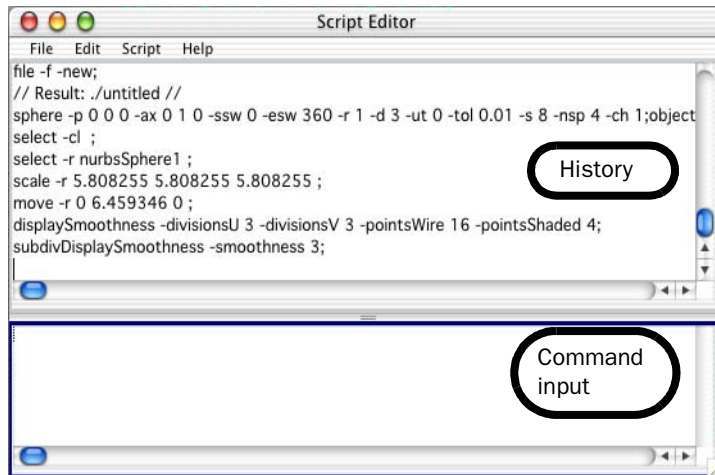

The top part of the Script Editor shows the command history—a running list of commands that you or Maya have executed. The results of the commands are listed between pairs of “//” characters. The meaning of the results will initially be unclear until you become familiar with MEL scripting.

The bottom (white) part of the window is the input section where you enter commands or scripts. If you make a typing mistake while entering commands, an error message appears in the history section.

- 2 In the input section, type the following command exactly as shown. Entries are case sensitive. The semicolon (;) signifies the end of the command.

```
sphere;
```

- 3 To execute the command, press Enter on the numeric part of your keyboard. The Enter (Windows and Linux) or Return (Mac OS X) key you normally use does not execute a command. It starts a new line so you can type several commands before executing them.

After you execute the command, Maya creates a NURBS sphere at the origin.

- 4 Enter the following command to delete the sphere.

```
delete;
```

This deletes the selected object, which, by default, is the last object you created.

Alternatively, you can enter individual MEL commands in the Command Line near the lower-left corner of the Maya window. This saves you the time it takes to display the Script Editor. In addition, the Command Line keeps a history of commands which can be readily accessed using the up and down arrow keys when working in it.

- 5 Create a bigger sphere:

```
sphere -radius 5 -name Planet;
```

The sphere, named Planet, has a radius of 5 grid units.

- 6 Move Planet to a new position:

```
move -relative 3 0 0;
```

This moves the selected object to a position 3 units in an X-axis direction (and 0 in Y and Z), relative to its current position. The option *-relative* is known as a flag (or argument).

13 | MEL

Lesson 1 > Creating a Shelf button for a MEL command

- 7 Select Help > MEL Command Reference to see a list of commands sorted by name. Find the move command and click its link to see the command description.

Maya includes command reference material that describes how to use each command and its flags. Alternatively, you can get quick help on a particular command directly in the Script Editor by typing the word help followed by the name of the command you wish to obtain more information about. For example, typing `help move` in the Script Editor will provide information about the various flags available to modify the move MEL command.

In the Flags section, you will see `-r/-relative` and a description of the flag. The slash between `-r` and `-relative` means that you have a choice of typing `-r` or `-relative`. So you could have typed the following command instead of the prior one:

```
move -r 3 0 0;
```

- 8 Delete Planet.

Creating a Shelf button for a MEL command

In the next steps, you'll create a Shelf button that executes three commands. The commands create a pair of lights that you can use for a default simple lighting arrangement in your scenes.

To create a Shelf button for MEL commands

- 1 In the Script Editor, select Edit > Clear History. This removes all text from the history section of the Script Editor to lessen clutter.
- 2 Select Create > Lights > Directional Light. A directional light is similar to the sun. Its parallel rays strike all objects in the scene from a single direction.
- 3 Use the Rotate Tool to rotate the light's Rotate X value to -35 or so. To ensure that the Shelf button works correctly, use the Rotate Tool, not the Channel Box or Attribute Editor. This rotational change gives the light a downward sloping direction.

Do not use the Channel Box or Attribute Editor when changing attributes for the purpose of creating custom Shelf buttons as these editors set attributes for uniquely named nodes vs. executing the commands for whatever is currently selected.

Lesson 1 > Creating a Shelf button for a MEL command

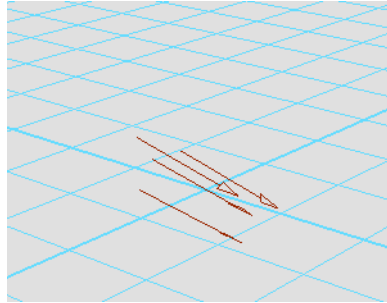

- 4** In the history section of the Script Editor, highlight the following command text:

```
defaultDirectionalLight(1, 1,1,1, "0", 0,0,0);
rotate -r -os -35.048621 0 0 ;
```

- 5** Left-mouse drag (Mac OS X) or Middle-mouse drag (Windows and Linux) the text to the input section of the Script Editor.
- 6** Select Create > Lights > Ambient Light. An ambient light emits light uniformly in all directions. It's useful for simulating low-intensity indirect lighting, like lighting reflected off the walls of a room.
- 7** In the history section of the Script Editor, drag through the following text to highlight it:

```
defaultAmbientLight(1, 0.45, 1,1,1, "0", 0,0,0, "1");
```

- 8** Left-mouse drag (Mac OS X) or Middle-mouse drag (Windows and Linux) the text to the line below the existing two lines in the input section. It will appear as follows:

```
defaultDirectionalLight(1, 1,1,1, "0", 0,0,0);
rotate -r -os -35 0 0 ;
defaultAmbientLight(1, 0.45, 1,1,1, "0", 0,0,0, "1");
```

If the dragged text is positioned to the right of the second line rather than on its own line, position the cursor to the left of defaultAmbientLight and press Enter on the alphanumeric part of the keyboard.

13 | MEL

Lesson 1 > Creating a Shelf button for a MEL command

With the desired statements in the input section, you could execute them by pressing Enter (numeric pad). Instead, you'll create a button on the shelf so you can execute the commands now or later, in any scene you create.

- 9 Select the General Tab on the Shelf so it is displayed. The shelf is the row of icons immediately above the scene view.
- 10 Highlight the three lines of text in the input section and from the Script Editor menu select File > Save Selected to Shelf.

A window appears prompting to enter the name of the new shelf item.

- 11 Type `LightB` and press Enter.



The button named `LightB` with a MEL icon appears on the shelf.

- 12 Click the MEL button. The command text executes and creates the lights.

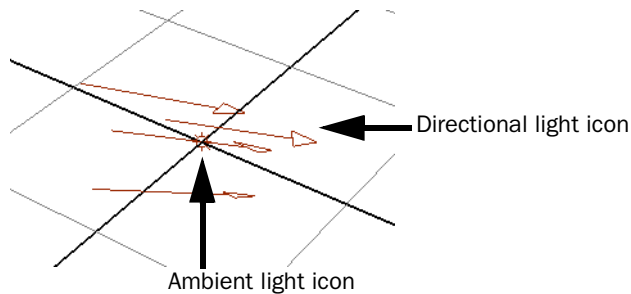

If you later decide to remove the button from the shelf, you can middle-mouse drag it to the Trash icon on the shelf.

If you forget the purpose of a button, move the pointer over it. A pop-up box lists the first command or two that the button executes. For easier recognition, you can optionally customize the display of a button by adding an overlay label to it.

Lesson 1 > Creating a Shelf button for a MEL command

You can edit the contents of Shelf items by selecting Window > Settings/Preferences > Shelves. For further information and related techniques, refer to the Maya Help.

Now you'll use the MEL button to create the lights and observe their effect on a sphere.

To use the MEL button

- 1** Delete the lights from the scene or create a new scene.
- 2** Create a polygonal sphere.
- 3** In the perspective view, press 5 on your keyboard (for Shading > Smooth Shade All).
- 4** Click the MEL button to create the directional and ambient lights.
Maya creates the lights at the origin. The icons representing them are hidden by the surface of the sphere. By default, Maya lights the scene with a single invisible directional light that points in the same direction as the scene view.
- 5** From the perspective view menu, select Lighting > Use All Lights to light the scene with the lights you just created.
- 6** To return to the default lighting for comparison, select Lighting > Use Default Lighting.

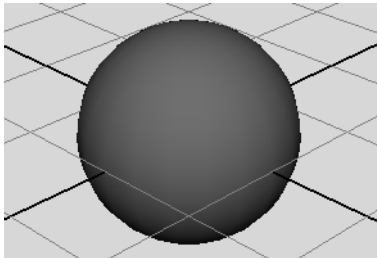

Default lighting

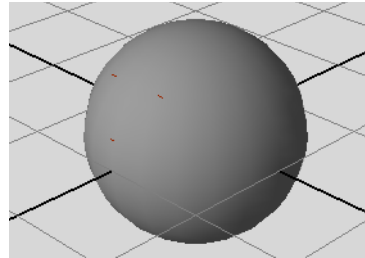

Lighting from MEL button

Tip To create a shelf button for a single menu item, for instance, Display > Grid, hold down Shift-Ctrl-Alt (Windows and Linux) or Shift-Control-Option (Mac OS X) while selecting the menu item.

Downloading Alias MEL scripts

A MEL script is a file containing a collection of MEL procedures and commands. As mentioned in the lesson's introduction, you can extend Maya's capabilities with scripts. In the next steps, you obtain a free script available on our customer community Web site.

- 1** Create a new scene before starting the next part of the lesson.
- 2** Using your computer's installed Web browser, navigate to the Alias web site (www.alias.com) and then choose the *Downloads* link.

Note In the dynamic world of the Internet, Web site contents are subject to modifications to suit customer needs. The following instructions were accurate at the time this document was published. If the instructions seem incorrect, peruse the Alias Web site for likely alternative routes to the free MEL scripts area.

To view and download content from the Downloads area you will need to register. (Be sure to read the Terms and Conditions of Use document available from that page.)

The Downloads area provides a search engine to access the many shaders, plug-ins and MEL scripts available for download.

- 3** Use the *Find a Download* search engine to search for Maya MEL scripts, and choose *spiral.mel* to obtain a script that creates a spiral curve based on values you supply for height, radius, and number of revolutions ("rounds").
- 4** In the file browser that appears, select the appropriate destination directory for the scripts file to download to. For example:

(Windows) `drive:\Documents and Settings\username\My Documents\maya\scripts`

(Mac OS X) `Users/username/Library/Preferences/Alias/maya/7.0/scripts`

(Linux) `~username/maya/scripts`

Substitute your specific hard drive letter and login name where *username* and *drive* appear in the above paths.

Many of the shaders and scripts in the downloads area of the Web site are compressed to reduce download time. Ensure that the MEL script is uncompressed (if necessary) before proceeding. To see how to execute the script, you need to examine the contents of the `spiral.mel` script for comments and clues.

To examine the MEL script's contents

- 1 In the Script Editor, select File > Open Script. In the resulting browser, open `spiral.mel`. The script appears in the Input area of the Script Editor.
- 2 Read the comments in the file—the text following the `//` characters. The comments describe the purpose of the script in addition to copyright and disclaimer information.

Notice the following line in the script:

```
global proc string spiral( float $ht, float $radius,  
float $numRounds)
```

The three variables within the parentheses, `$ht`, `$radius`, and `$numRounds` are *arguments* to the procedure `spiral`. They represent values that you must enter when you execute the `spiral.mel` script in a later step. The variables specify the height, radius, and number of rounds for the spiral curve that will be created when you execute the script.

The entry *float* is short for floating point—the data type of an argument. A floating point number is a number with a decimal point rather than an integer.

To execute the MEL script

- 1 To execute the script, enter the following text in the input section of the Script Editor. Remember to press the numeric Enter key after the text.

```
spiral 5 2 10;
```
- 2 Maya finds the `spiral.mel` script in the `scripts` directory and executes the script contents to create the following spiral curve of height 5, radius 2, and 10 rounds:

The script file must be in the appropriate *scripts* directory or your script will not execute when you enter its name in the input section of the Script Editor.

13 | MEL

Lesson 1 > Creating a user interface slider using a MEL script

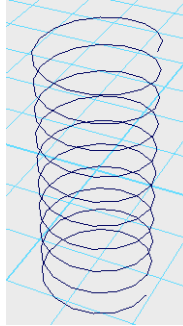

Creating a user interface slider using a MEL script

In the next steps, you'll create a MEL script, save it to disk, and execute it. The script creates a user interface slider for controlling an attribute value. The advantage of creating a script file rather than a MEL button is that a script is portable. You can copy a script to another user's scripts directory easily.

- 1** In the Script Editor, select Edit > Clear All to erase all text from the history and input sections of the Script Editor.
- 2** In the input section of the Script Editor, type the following text. In the text after the dotted line, use the exact lowercase and uppercase letters shown:

```
// Creation Date: <Date>
// Author: <Your Name Here>
//
// Description: This script creates a custom slider that
// controls the Translate Y attribute of an object named
// pSphere1.
// -----

global proc MySliderMaker()
```

Lesson 1 > Creating a user interface slider using a MEL script

```

{
window -title "Slider for pSphere1.ty" SliderTest;
columnLayout;
attrFieldSliderGrp
-min 0
-max 10
-at "pSphere1.ty";
showWindow SliderTest;
}

```

Statements that follow a pair of backslash characters (//) are comments for other people who might read the script later to extend its capability. Maya ignores these statements. The remaining text is a procedure—a collection of MEL commands and operations contained in braces and given a name.

The procedure's name is `MySliderMaker`. In technical terms, the procedure is a global procedure, which means it can be executed from any other script in Maya.

- 3 Drag through the entire text to highlight it.
- 4 From the Script Editor menus, select File > Save Selected. In the file browser that appears, enter the name `MySliderMaker.mel`. By default, Maya automatically saves the text as a script file in the appropriate script directory.

Also, the base name of the script file must be the same as the name of a global procedure in the script. In this example, the script file has only one global procedure, `MySliderMaker`, so you must name the script file `MySliderMaker.mel`. (Script files always end with the extension `.mel`.)

If the system reports an error with your procedure it may mean you've made an error when typing. You will need to either correct the error or delete the global procedure's name and start again. If you are new at writing MEL scripts, it's best to position the global procedure (the one with the same name as the script file) as the last procedure in the script. Your script will be more likely to run without error.

13 | MEL

Lesson 1 > Creating a user interface slider using a MEL script

The first line of the `MySliderMaker.mel` script is a procedure declaration. It informs the software that the lines between curly braces (`{ }`) are a related series of operations.

In general, a global procedure has this form:

```
global proc procedureName ( )  
{  
    commands  
}
```

Maya executes the commands within the curly braces every time you enter the corresponding MEL script filename in the Script Editor. Be aware that using global procedures might cause errors if another script contains an identical procedure name. There are techniques involving the use of local procedures for avoiding such errors. See the Maya Help for details.

- 5 Select **Create > Polygon Primitives > Sphere**. By default, this creates a sphere named `pSphere1`. Press `5` to display the sphere with smooth shading.
- 6 Type: `MySliderMaker` in the input section of the Script Editor and press **Enter** on the numeric keypad. Do not type the `.mel` extension. Unlike the script you copied from www.alias.com earlier in the lesson, you do not type any arguments (for instance, `-5`) after the script name. Some scripts require you to type arguments. Others do not.

The `MySliderMaker.mel` script executes. It displays a custom slider that controls the `translateY` attribute of the object named `pSphere1`. (Drag the right edge of the slider window, if necessary, to see the entire slider.) Drag the slider back and forth to move the sphere up and down.

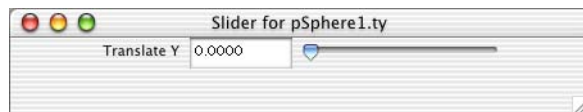

Next, you'll learn about the four commands that make up the `MySliderMaker` procedure on a line-by-line basis. The commands are listed below:

```
window -title "Slider for pSphere1.ty" SliderTest;  
columnLayout;
```



```
attrFieldSliderGrp -min 0 -max 10 -at "pSphere1.ty";  
showWindow SliderTest;
```

The first command creates a window with a title bar (the `-title` flag) that contains the text string *Slider for pSphere1.ty*. The internal name of the window is `SliderTest`. The window is displayed only when the fourth command executes.

The second command creates the window layout in a column format.

The third command creates a slider group that consists of the label, text entry field, and slider. The slider value can range from a minimum of 0 to a maximum of 10. The entry `-at pSphere1.ty` specifies that the slider controls the translate Y attribute (`ty`) of `pSphere1`.

Beyond the lesson

This lesson provided an introduction to using MEL for creating custom features in Maya. In this lesson you learned how to:

- Use the script editor for MEL commands.
- Use MEL to create customized interface components.

If you have never used a scripting or programming language, a few concepts in this lesson might seem foreign. With a little study and experimentation with MEL, you'll quickly find ways to work more productively with Maya.

To become a successful MEL user, you need to learn the basics of the language. For details on the language and example scripts, see the Maya Help. The Maya Help MEL *command reference* includes examples of command usage at the bottom of most command descriptions.

If you have previously used a scripting or programming language before, you'll have little difficulty working with MEL. If you've worked with the C language, you'll have a head start; MEL uses many of the language elements of C, including data types and flow control methods.

Behind the lesson

Early in the lesson, you moved the following three lines of text from the Script Editor to a MEL button:

13 | MEL

Lesson 1 > Beyond the lesson

```
defaultDirectionalLight(1, 1,1,1, "0", 0,0,0);  
rotate -r -os -35 0 0 ;  
defaultAmbientLight(1, 0.45, 1,1,1, "0", 0,0,0, "1");
```

For brevity, we referred to the three lines as MEL commands. Only the second is a command; the other two lines are procedures.

A MEL procedure is a collection of MEL commands that are accessed by executing only the name of that procedure (and any associated arguments) instead of executing the individual MEL commands one at a time. Procedures differ from MEL commands in that they require specific arguments in order to execute. These arguments are not optional such as they are with a MEL command flag option.

Although the procedures often have similar results to MEL commands, the syntax is different and you won't find documentation of how to use them in the Maya Help MEL command reference.

If you want to know whether a statement you see in the Script Editor is a command or procedure, enter the command *whatIs* in the Script Editor as in the following example:

```
whatIs defaultDirectionalLight;
```

Depending on your computer platform and version of Maya you'll see a response in the Script Editor similar to this:

```
// Result: Mel procedure found in: drive:/aw/Maya7.0/scripts/  
others/defaultDirectionalLight.mel
```

This means that `defaultDirectionalLight` is a procedure in a script named `defaultDirectionalLight.mel`. You can tell that the script is part of the Maya software based on its location. The custom scripts you create instead must reside at `Users/username/Library/Preferences/Alias/maya/7.0/scripts..`

Note Be cautious if you decide to modify the supplied Maya software scripts in case you accidentally change one by mistake. You may wish to first duplicate and rename it before modification. Create and modify only your own scripts.

If you want to create lights with a MEL button, you don't need to use internal procedures such as `defaultDirectionalLight`. You can instead use MEL commands such as `directionalLight`. As usual with Maya, there are several ways to get the results you want.

You are not required to use the command history in the Script Editor when you create a MEL button. It's there for convenience.

Note There is no guarantee that the history text you copy to a MEL button will have the same result as the user interface actions from which the text was generated. There are subtle issues in MEL command sequences that make them work in one workflow, but not in another. You need to check the results and make modifications as necessary.

By default, not all Maya operations appear in the command history as you use the interface. Maya filters out many of the actions you usually don't need to see. To see all operations, select `Script > Echo All Commands` (from the Script Editor window). This might be necessary if you are having difficulty getting the desired result from a text you copy to a MEL button.

13 | MEL

Lesson 1 > Beyond the lesson

Index

Symbols

% in expressions 599
.mel extension 612
// in MEL script 611
<< >> in expressions 596
{ } in expressions 590
{ } in MEL scripts 612

Numerics

3D Paint Tool 555

A

active rigid body 501
Add Attribute button 595
Add Attributes 488
 for Current Render Type 487
Add Dynamic Attributes 488, 595
Add Influence 319
Add Keys Tool 179
Add Per Particle Attribute 488, 595
age, particles 490

Alias
 education and learning tools 27
 technical support 28
 Web site 27
Along Axis 480
Ambient Light 605
animation 165–294
 curves 172
 motion path 189–209
 planning, storyboarding 285
Animation Preferences 168
Annotation
 creating 268
 description 268
anti-aliasing 392, 455
arguments
 MEL command 603
 MEL procedure 609
arms
 joint chain 301
Around Axis 480, 483
array
 description 488
Artisan Erase 558
Assign Edit Textures button 556
Assign New Material 402
Assign Textures button 565

assigning a texture map 346
Attribute Editor
 attribute tabs 88
 description 87
 viewing 87
Attribute to Paint 556, 565
attributes
 controlling multiple 578
 description 55
 displayed in Attributes list 574
 linking 578
 shading 90
audio clips 249
Automatic Mapping 356, 357
 applications 356
 triplanar projection 356
Away From Axis 480, 483
axis indicator 37

B

base object
 influence object 319
base shape
 blend shape 339
birth, particles 490
blend modes 557

Index

- blend shape deformer 330
 - adding shape to 336
 - editor 331
 - improving deformations 338
- blending animation types 202
- Blinn shading material 375, 377
 - description 90
- Blur, 3D Paint 564
- bones 297
- Bounding Box 182
- braces, in statements 590
- brackets, double angle 596
- Break Tangents
 - Graph Editor 175
- Browse button 560, 566
- brush profile 562
- brushes
 - 3D Paint, Paint Effects 562
 - description 523
 - Kelp 539
 - Mesh 544
 - Teapot 545
 - Thin Line 553
- bump, painting 565
- C**
- C language
 - MEL 613
- camera
 - applications 433
 - create 433
- Camera Attribute Editor 387
- camera tools
 - Dolly Tool 63
 - overview 62
 - Track Tool 65
 - Tumble Tool 64
- cameras
 - animating 435, 438
 - Film Gate 438
 - undoing changes 436
- Canvas
 - Clear 513
 - Set Size 512
- Canvas Clear 510
- Caustic Accuracy 472
- Caustic Photons 472
- Caustic Radius 472
- Caustics 458–474
 - Caustic Photons 467
 - description 458
 - Emit Photons 467
 - light sources 474
 - Photon Intensity 467
 - photon maps 466
 - photons 466
- Channel Box 43
 - blend attributes 204, 206
 - description 55
 - hiding, showing 43
 - locking channels 273
 - naming and renaming objects 56
 - transforming and rotating objects 55
 - translation, rotation, scaling 43
- character set 218
- character setup 295–339
 - description 295
- Circle 138
- Clear All
 - Script Editor 610
- clear canvas 510
- Clear History
 - Script Editor 604
- clip cycle
 - description 235
- clip library 243
- clip manipulator 230

- clips
 - applications 213
 - audio 249
 - blending 249
 - components 217
 - creating 216, 219
 - cycling 235
 - description 210, 213
 - duration 217
 - importing 225
 - inserting 244
 - keyframing 249
 - name 217
 - Outliner 249
 - regular clips 216
 - renaming 220
 - repositioning 222
 - reusing 225
 - scale 218
 - scaling 230
 - source 216, 225
 - Visor 249
 - cloth texture 380, 381
 - cluster deformer 324
 - cluster handle 325
 - cluster weights 327
 - Collapse 269
 - collapse hierarchy 269
 - collisions, rigid bodies 496
 - Color 557
 - color
 - Christmas light effect
 - with particles 598
 - giving object constant
 - color 595
 - giving particles randomly
 - changing color 596
 - particles 488
 - ramp 489
 - color bleeding 454
 - Color Chooser 91, 389
 - command history
 - MEL 603
 - Script Editor 615
 - Command Line 603
 - commands
 - moving to Shelf 604
 - comments
 - MEL script 609
 - components
 - description 84
 - selection 84
 - conditional statements
 - if 585
 - Conserve attribute 485
 - constraints 496
 - description 266
 - orient 271
 - parent 281
 - point 269
 - rigid bodies 496
 - construction history 118, 144
 - control object (IK) 266
 - control vertices (CVs) 117
 - description 85
 - converting a UV selection
 - 365
 - creasing
 - subdivision surface 162
 - Create
 - Expression Editor 574
 - Create Blend Shape 331
 - Create Clip
 - options 234, 235
 - Create Cluster 325
 - Create Constraint 499
 - Create Ramp 489
 - creation expressions 596
 - assigning to rgbPP 595
 - cube primitive 39, 98
 - options 67
 - curve
 - direction 117
 - edit revolved 118
 - start 117
 - cutting
 - subdivision surface 157
 - CV Curve Tool 117
 - cycling a clip 235
- D**
- Delete Keys 309
 - detail
 - subdivision surface 158
 - Dim Image 358
 - directional light
 - create 423
 - description 423
 - editing attributes 424

Index

- display
 - only selected object 334
 - template 82
- Display Image 360, 365
- Display Level 159
- Display Resolution 387
- Display Unfiltered 368
- Dolly Tool 63
 - description 63
- double angle brackets 596
- Draft rendering setting
 - description 443
- driven keys
 - description 183
- Duplicate Tool 140
 - description 56, 77
 - options 57, 69
- Duration 217
- dynamic attributes
 - adding 487, 594
- dynamics 475–503
 - definition 475
- E**
- Echo All Commands 615
- edges
 - selecting subdivision surface 160
- Edit Blend Shape > Add 336
- Edit button
 - expressions 577
- Edit Ramp 494
- elbow
 - influence object 318
- electronic tablet
 - sculpting surfaces 130
- else keyword
 - expressions 589
- Emit from Object 477
- emitters 476
 - creating 477
 - Omni 478
- End Bounds 528
- End Time 168
- equal to (==) operator 599
- errors
 - syntax 586
- Essential Skills Movies 22
 - closing the movie window 23
 - playing 22
- exiting Maya 44
- Expression Editor 573
- expressions 571–600
 - advantage of separate 579
 - advantage of single 579
 - creating 574
 - description 571
 - editing 577
 - execution details 580
 - naming conventions 573
- Expressions lessons 18
- Extrude Face 98
- extrusion
 - depression 107
 - manipulator 99
 - rotate 104
- extrusion manipulator
 - subdivision surfaces 155
- F**
- faces
 - selecting polygon 98
- facial animation 322
- FCheck 397, 494
- fields 476, 494
- file saving 44
- fingerails 160
- fingers 151
- Flipbooks 494
- float 609
- Flood
 - Sculpt Geometry Tool 127
- Flood All 559
- Forward Kinematics (FK) 250, 305, 309
- Four Panes 117
- Frame In 217
- Frame Out 217
- Frame Selection
 - Graph Editor 173
- frames per second setting 374
- Freeze Transformations
 - description 267

Full Crease Edge/Vertex 162

G

Get Brush icon 562

Getting Started with Maya
 about the lessons 18
 additional lessons 18
 before you begin 19
 copying lesson files from
 CDROM 21
 introduction 17–29
 lesson conventions 20
 using lesson files 21
 using tutorials online 19

Global Illum Photons 448,
 453

Global Illumination 439–457
 color bleeding 454
 description 439
 Global Illum Accuracy
 452
 Global Illum Radius 452
 light sources 456
 photon maps 447
 photons 447
 rendering process 446,
 449

global procedure 611
 position in script 611

Go to Bind Pose 318

Graph Editor 172
 path animation 197
 Set Driven Key 187
 tangent modification 198

Gravity 500, 529

ground plane 524

group nodes
 animating 182

Group Under 323

grouping objects
 description 73

Growth attributes 551

H

hardware render 492

Hardware Render Buffer 492

Hardware renderer
 description 385

Help

Find Menu 27
 launching 23

Help resources 22

Hide Selection 144

hierarchy
 about 252
 collapse 269, 281
 description 73
 grouping 73
 skeleton 297
 viewing in hypergraph
 254

Hinge constraint 499

hole
 creating subdivision
 surface 157

Hotkeys
 brush scale 540
 description 76
 setting 76

Hypergraph 74

character setup 298
 description 74
 overview 75
 viewing 74
 viewing hierarchies 74

Hypershade

Create Textures 413
 description 410
 rename operation 413

I

if statements
 expressions 582

if-else statements
 expressions 588, 589

IK handles 305
 control object 266
 creating 263
 creating and animating
 306
 description 263
 parenting 276

IK Rotate Plane handle 308

IK Solvers
 Enable and Disable 317
 ikSCsolver 264

image size 443, 454, 463

Import Clip 225

Incandescence1 563

Influence list
 Paint Skin Weights Tool
 314

Index

influence object
 smooth skin 317
initial orientation
 hinge constraint 500
Insert Isoparms 134
Inverse Kinematics (IK) 250–
 294
 description 250, 305
 limiting motion 273
 translation limits 280
IPR 566
 description 385
 region to be updated 389
IPR Render Current Frame
 387
Isolate Select 334
isoparms 123

J

jaw
 joint 300
joint chains 297
Joint Size 297, 312
Joint Tool 297
joints 297
 influence on skin 312
 moving 301

K

Keep Aspect Ratio 556

Keep Image 445, 465
keyframes (keys)
 adding 179
 deleting 180
 description 166
 setting 168
keying into a clip 249
keys
 delete redundant 180
 Key Selected 292
 moving 174
 setting 289

L

Lambert shading material
 375, 376
layouts
 changing panel layout 50
 four view layout 57
 shortcuts 50
Leaf Width Scale attributes
 550
Leaves attributes 551
legs
 joint chains 297
level of detail
 subdivision surface 158
lifespan attribute 490

lights

 applications 421
 attributes 428
 directional 531
 dropoff 429
 intensity 532
 MEL button 604
 penumbra 429
 spotlight 425, 444
Line Smoothing 493
Line Width 487
Linear
 Graph Editor tangents
 174
linking attributes 578
Load Driver
 Set Driven Key 185
Load Selected Characters
 216
Loft Tool 138, 141
Look Through Selected 427

M

Magnitude 480
main menu 38
Make Paintable 539
Map Visualizer 456, 474
mapping UVs 355
 applications 355
marking menu 85
masks and modes, selection
 description 78

- material
 - assigning 402
 - Blinn 375
 - default shading 89
 - description 375, 402
 - Lambert 375
 - surface 89
 - Max Displacement 129
 - Max Influences 312
 - Max Photon Depth 470
 - Max Refraction Photons 470
 - Maya
 - about 17
 - installing 19
 - launching 33
 - user interface 33, 34
 - using Maya Help 23
 - Maya Basics 31–93
 - Maya Hardware renderer
 - description 385
 - Maya Help
 - index 24
 - popup help 25
 - Tutorials 19
 - using 23
 - using Help index 24
 - using Help Line 26
 - using Search 24
 - Maya Software renderer
 - description 385
 - Maya Unlimited 18
 - Maya Vector renderer
 - description 385
 - MEL 601–615
 - comments in script 609
 - creating scripts 610
 - description 601
 - procedure 611
 - mental ray for Maya renderer
 - 372, 462
 - description 385
 - menu item
 - move to shelf 607
 - menu sets 38
 - description 38
 - selection 39
 - Mesh brushes
 - applications 544
 - attributes 549
 - description 544
 - meteors 486
 - Mirror Across 299
 - mirroring
 - Sculpt Geometry strokes 132
 - modules 38
 - modulus operator (%) 599
 - morphing facial expressions 331
 - motion
 - speeding up with Graph Editor 176
 - motion capture data
 - creating clips from 233
 - description 231
 - extending the length of 234
 - redirecting 239
 - Motion Path
 - Attach to Motion Path 191
 - motion path animation 189–209
 - description 189
 - move
 - key points 174
 - objects 53
 - UVs 365, 366
 - Move and Sew UVs 362
 - Move Tool 52
 - N (normal) manipulator 161
 - X, Y, Z manipulator 52
 - mute track 229, 244
- N**
- neck
 - joints 300
 - new scene 47
 - nodes
 - description 55
 - initialShadingGroup 89
 - input 89
 - parent 75
 - pivot point 79
 - renaming 75
 - root 75
 - shape 88
 - transform 88
 - nonlinear animation 210–249
 - description 210
 - non-proportional scaling 71

Index

normals
 surface 126
Number of Sections 123
 Circle 138
Number of Spans 123
NURBS
 applications 115
 creating NURBS curves 117
 description 115
 editing tools 145
 Loft Tool 138
 sculpting NURBS surfaces 122
 Smoothness 124
NURBS Modeling 115–145

O

object selection 52
offset 270
Opacity 557
 Paint Cluster Weights Tool 328
 Sculpt Geometry Tool 129
operators
 assigning values to 599
 equal to 599
 less than 585
order of statements 587
orient constraint
 creating 272
 description 271
origin 36

orthographic view 62
Outliner 216, 220, 249
 description 119, 143
 parenting objects 144
 placing clips from 226
Output window 391

P

paint brushes
 blending 517
Paint Effects
 3D objects 535, 539
 applications 553
 Brush Settings window 563
 brushes, 3D Paint 562
 making surfaces paintable 539
 panel 532
Paint Effects to Polygons 547
Paint Selection Tool 325
Paint Skin Weights Tool 314
Paint Weight Menu 315
painting 505–569
 2D strokes 508
 3D strokes 521
 3D strokes in scene view 524
 bump 565
 interactively 565
 pressure sensitivity 521
 strokes 523
 UV preparation 568
pairBlend attribute 207
panel 36
panel layout 448, 461
parent constraint
 description 281
 weighting 284
parent node 75
parenting
 description 259
particle attributes, per object and per particle 488
particle object 478
particles
 applications 475
 changing form of 486
 description 476
 render type 486
 streaks 486
path animation 189–209
 blending 202
 description 189
 position marker 195
 Twist attribute 200
 UValue 194
per object attributes 488
Per Particle (Array) Attributes 596
per particle attributes 488
 how to distinguish 488
perspective view 62
Photon Intensity 448, 451, 470
photon maps 466, 474
 description 447
 visualizing 456

- photons
 - Caustic Accuracy 472
 - Caustic Photons 472
 - Caustic Radius 472
 - description 447
 - Emit Photons 448
 - Global Illum Photons 448
 - Max Photon Depth 470
 - Max Refraction Photons 470
 - Photon Intensity 448, 451, 470
 - photon maps 474
 - pivot point
 - description 79
 - playback
 - animation 291
 - controls 168
 - quickenning 180
 - speed 168
 - Playblast 171, 180
 - description 208
 - point constraint
 - description 269
 - pole
 - surface 128
 - Pole Vector Constraint 308
 - Pole Vector XY Z 308
 - Polygon Proxy Mode 150
 - Polygon Texturing 341–370
 - polygonal cylinder
 - creating 48
 - options 49
 - Polygonal Modeling 95–113
 - Polygons to Subdiv 149
 - primitives
 - applications 46, 48
 - creating 39
 - creating from Shelf 41
 - modifying 142
 - NURBS sphere 70
 - NURBS torus 83
 - plane 536
 - polygonal cube 67
 - polygonal cylinder 48, 68
 - types 47, 137
 - procedural textures 376
 - description 379
 - procedure
 - global MEL 611
 - MEL 611
 - process 371
 - project
 - creating 58
 - description 58
 - projection mapping UVs 356
 - PSD file format 349
- Q**
- Quaternion rotation 207
- R**
- Radius 557
 - Circle 138
 - Sphere 123
 - Radius(L) 130
 - Radius(U) 126
 - Paint Cluster Weights Tool 328
 - Paint Skin Weights Tool 316
 - rain 486
 - ramps 489, 494
 - Range Slider 168
 - raytracing 441
 - Redirect Tool 239
 - creating redirect control 239
 - keyframing control 241
 - options 240
 - positioning control 240
 - Refine Selected
 - Components 161, 163
 - Reflection
 - Sculpt Geometry Tool 131
 - Reflection X 558
 - refractions
 - Max Trace Depth 469
 - photon refraction 469
 - refraction levels 469
 - renaming clips 220
 - Render Current Frame 531
 - Render Sequence 493
 - Render Settings 392, 442
 - render types, setting for particles 486
 - Render View 386, 463, 566
 - Keep Image 445, 465

Index

- rendering 371–438
 - anti-aliasing 455
 - batch rendering 394, 399
 - compositing layers 399
 - description 371
 - hardware 372, 399
 - image size 443, 454
 - methods 372
 - overview 373
 - panel layout 448, 461
 - raytracing 441
 - render settings 442
 - sampling 455
 - shading surfaces 401
 - shadows 444
 - software 372, 384
 - view region to be rendered 387
 - rendering particles 494
 - Replace
 - Paint Cluster Weights Tool 328
 - return to start time 168
 - reusing clips 225
 - Revolve Tool 116
 - creating surfaces 118
 - editing surfaces 118
 - rewind 168
 - rgbPP attribute 488
 - use in expressions 595
 - ribs
 - joints 301, 302
 - ridges
 - subdivision surface 162
 - rigid bodies 496
 - active 501
 - applications 475
 - collisions 496
 - constraints 496
 - passive 501
 - rigid skinning 321
 - root
 - skeleton 305
 - root node 75
 - Rotate Tool
 - description 53
 - X, Y, Z manipulator 54
 - Rotate UVs 367
 - rotating objects
 - options 71
 - rotInterpolation 207
 - runtime expressions 597
 - assigning rgbPP in 597
- S**
- sampling 455
 - Save As 555
 - Save Scene 44
 - Save Selected
 - MEL 611
 - saving files 44, 59, 80
 - Scale
 - Paint Skin Weights Tool 316
 - scale
 - non-proportional 71
 - scale, multiplying by
 - percentage 591
 - scaling clips 230
 - scene painting view 533
 - scene view vs Render View 386
 - Script Editor 602
 - opening script 609
 - scripts
 - directory location 608
 - executing 609
 - MEL 601
 - obtaining free 608
 - scrub 169
 - Sculpt Geometry Tool 122, 125
 - basic techniques 125
 - preparing surfaces 122
 - sculpting terrain 537
 - Section Radius 483
 - selection
 - hierarchy 78
 - hierarchy, object, component 78
 - masks and modes 40, 78
 - mode 40
 - objects 42, 52
 - UVs 359, 361
 - semicolon terminator
 - expressions 574
 - MEL 603
 - Set Driven Key 184
 - Graph Editor 187
 - Set Initial Position 500
 - Set Key 169
 - Set Preferred Angle 306
 - sewing UVs 362

- shaded mode 72, 548
- shading material
 - assigning 89
 - Blinn 90
- shading networks
 - description 379
- shading surfaces 401
- shadows 444, 462
 - description 431
- Shape
 - Sculpt Geometry Tool 130
- Shelf 41
 - preset brushes 523
 - saving preset brushes 516
- Shelf button
 - creating 604
- Show Manipulator Tool
 - extruding polygons 100
- Show Region Marquee 390
- Show/Hide Editor 40
- Size X, Size Y 556, 565
- skeletons 296
 - creating 256
 - hierarchy 256
 - moving group node 308
 - parenting models 259
 - posing and animating 306
 - root 305
- skin 311
- skin weights 312, 314
 - modify 315
- Smear 564
- Smear, 3D Paint 564
- Smooth
 - Paint Skin Weights Tool 316
 - polygons 111
- Smooth Bind 312
- Smooth Shade All 375
- smooth skin 312
 - influence object 317
 - unnatural deformation 313
- Snap Mode 40
 - Snap to Grids 112
 - Snap to Points 139
- Software renderer
 - description 385
- software rendering 384
- solo track 229
- source clip 216
- Source In 217
- Source Out 217
- spans, displaying 124
- sphere primitive 70
 - options 86
- sphrand function, use with
 - random color 597
- spinal column
 - joint chain 300
- spine
 - parenting arms and legs 304
- spiral.mel 608
- Split Polygon Tool 100
- Split Vertex 102
- spotlight
 - aiming 426
 - Cone Angle 429
 - description 425
- Stamp Spacing 561
- Standard Mode 158
- Start Time 167
- starting Maya 33
- statements
 - expression order 587
- static channels
 - remove 179
- Status Line 38, 39
 - expanding and collapsing items 40
- Streak render type 486
- stroke
 - attributes 526
 - attributes, Global Scale 528
 - attributes, Gravity 529
 - attributes, Turbulence 540
 - description 523
 - Stroke Refresh 534
- strokes
 - deleting 542
 - polygon conversion 547
 - rendering 530, 543, 546
 - tubes 525
- Stylus Pressure 130, 521, 557
- Subdivide
 - polygons 108

Index

- subdivision surfaces 147–164
 - converting polygons 148
 - cutting 157
 - Extrude Face 152
 - extrusion manipulator 155
 - selecting faces 152
 - selecting vertices 156
 - Split Polygon Tool 151
 - summary track
 - description 227
 - surface
 - material 89
 - normals 126
 - pole 128
 - syntax, errors 586
- T**
- Tail Fade 487
 - Tail Size 487
 - Tangent
 - Graph Editor 181
 - handles in Graph Editor 175
 - target
 - blend shape 331
 - template brush
 - description 510, 524
 - modifying settings 510
 - resizing 510
 - template display 82, 297
 - applications 82
 - description 82
 - untemplating objects 87
 - Test Render 492
 - texture map
 - applications 341
 - assigning 346
 - description 341
 - procedural 376
 - UVs 343
 - textures
 - cloth 380, 381
 - interactive 3D placement 417
 - procedural 379
 - The Art of Maya 19
 - ticks
 - red key 169
 - time
 - expressions 583
 - predefined variable 574
 - value at different frames 574
 - Time option 374
 - Time Slider 168
 - time warps 249
 - Toggle Texture Borders 364
 - applications 365
 - Tool Settings 555
 - Toolbox 49
 - transformation tools 51
 - torus
 - options 83
 - track 216
 - description 216
 - muting 229
 - soling 229
 - view area 218
 - Track Tool 65
 - description 65
 - transform nodes
 - not used for particle expressions 596
 - transparency, skin 313
 - Trash icon
 - Shelf 606
 - Trax Editor 210–249
 - character sets 218
 - clip library 243
 - clip manipulator 230
 - cycling a clip 237
 - Graph Anim Curves 224
 - Load Selected Characters 216
 - motion capture data 231
 - mute track 229
 - Offset attribute 238
 - panel layout 213
 - repositioning clips 222
 - scaling clips 230
 - solo track 229
 - summary track 227
 - time warps 249
 - Toolbar 219
 - track 216
 - triplanar projection 356
 - Tube Sections 550
 - tubes
 - attributes 550
 - Creation 546
 - editing attributes 515
 - Flower 546
 - Leaves 546
 - Tube Sections 550

Tumble Tool
description 64
Turbulence
options 541
Twist 308
Twist attribute 200
Two Panes Stacked 566

U

U Dir
Sculpt Geometry Tool
132
UI Elements 555
undo 55, 538
Update on Stroke 566
Use All Lights 607
Use Default Lighting 607
Use Depth Map Shadows
428, 432
user interface 33, 34
user preferences
restoring 29
saving 28

UV Texture Editor
applications 351
converting a selection
365
description 351
Dim Image 358
Display Image 360, 365
Display Unfiltered 368
Move and Sew UVs 362
move UVs 366
Rotate UVs 367
Toggle Texture Borders
364
viewing UVs 353

UVs

Automatic Mapping 356
description 343
image range 354, 355
mapping 355
modifying 359
moving 365, 366
preparing for painting
568
projection mapping 356
selecting 359, 361
sewing 362
shells 363
viewing 351, 353

V

V Dir
Sculpt Geometry Tool
132
Value
Paint Cluster Weights
Tool 328

Vector renderer
description 385
velocity
controlling in particles
485
vertices
selecting 101
subdivision surface 156
viewing rendered frames
397
viewing shaded objects 72
views
orthographic 62
perspective 62
shaded 72
wireframe 76
Visor 216, 249
description 226
placing clips from 227
preset brushes 523, 539
volume axis field 479
Volume Shape 479

W

whatIs command 614
workspace 35

X

X, Y, Z
axes 37
axis indicator 37
origin 36
X, Z ground plane 524

Index

X-Ray 313

Getting Started with Maya
630