

## PRINCIPLES OF TRADITIONAL ANIMATION APPLIED TO 3D COMPUTER ANIMATION

John Lasseter  
Pixar  
San Rafael  
California

"There is no particular mystery in animation... it's really very simple, and like anything that is simple, it is about the hardest thing in the world to do." Bill Tytla at the Walt Disney Studio, June 28, 1937. [14]

### ABSTRACT

This paper describes the basic principles of traditional 2D hand drawn animation and their application to 3D computer animation. After describing how these principles evolved, the individual principles are detailed, addressing their meanings in 2D hand drawn animation and their application to 3D computer animation. This should demonstrate the importance of these principles to quality 3D computer animation.

CR Categories and Subject Descriptors:

I.3.6 *Computer Graphics* : Methodology and Techniques - Interaction techniques;

I.3.7 *Computer Graphics* : Three-dimensional Graphics and Realism - Animation;

J.5 *Computer Applications* : Arts and Humanities - Arts, fine and performing.

General Terms: Design, Human Factors.

Additional Keywords and Phrases: Animation Principles, Keyframe Animation, Squash and Stretch, Luxo Jr.

### 1. INTRODUCTION

Early research in computer animation developed 2D animation techniques based on traditional animation. [7] Techniques such as storyboarding [11], keyframe animation, [4,5] inbetweening, [16,22] scan/paint, and multiplane backgrounds [17] attempted to apply the cel animation process to the computer. As 3D computer animation research matured, more resources were devoted to image rendering than to animation. Because 3D computer animation uses 3D models instead of 2D drawings, fewer techniques from traditional animation were applied. Early 3D animation systems were script based [6], followed by a few spline-interpolated keyframe systems. [22] But these systems were developed by companies for internal use, and so very few traditionally trained animators found their way into 3D computer animation.

"Luxo" is a trademark of Jac Jacobsen Industries AS.

Permission to copy without fee all or part of this material is granted provided that the copies are not made or distributed for direct commercial advantage, the ACM copyright notice and the title of the publication and its date appear, and notice is given that copying is by permission of the Association for Computing Machinery. To copy otherwise, or to republish, requires a fee and/or specific permission.

The last two years have seen the appearance of reliable, user friendly, keyframe animation systems from such companies as Wavefront Technologies Inc., [29] Alias Research Inc., [2] Abel Image Research (RIP), [1] Vertigo Systems Inc., [28] Symbolics Inc., [25] and others. These systems will enable people to produce more high quality computer animation. Unfortunately, these systems will also enable people to produce more bad computer animation.

Much of this bad animation will be due to unfamiliarity with the fundamental principles that have been used for hand drawn character animation for over 50 years. Understanding these principles of traditional animation is essential to producing good computer animation. Such an understanding should also be important to the designers of the systems used by these animators.

In this paper, I will explain the fundamental principles of traditional animation and how they apply to 3D keyframe computer animation.

### 2. PRINCIPLES OF ANIMATION

Between the late 1920's and the late 1930's animation grew from a novelty to an art form at the Walt Disney Studio. With every picture, actions became more convincing, and characters were emerging as true personalities. Audiences were enthusiastic and many of the animators were satisfied, however it was clear to Walt Disney that the level of animation and existing characters were not adequate to pursue new story lines-- characters were limited to certain types of action and, audience acceptance notwithstanding, they were not appealing to the eye. It was apparent to Walt Disney that no one could successfully animate a humanized figure or a life-like animal; a new drawing approach was necessary to improve the level of animation exemplified by the *Three Little Pigs*. [10]

FIGURE 1. Luxo Jr.'s hop with overlapping action on cord. Flip pages from last page of paper to front. The top figures are frames 1-5, the bottom are frames 6-10.

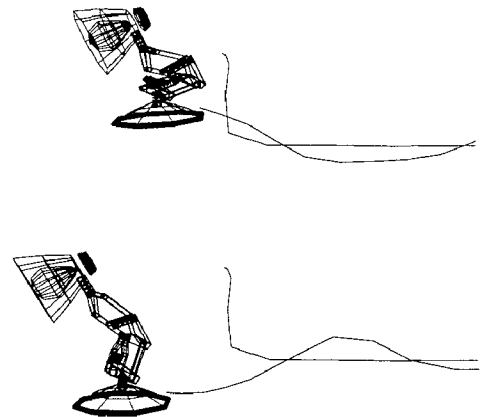

Disney set up drawing classes for his animators at the Chouinard Art Institute in Los Angeles under instructor Don Graham. When the classes were started, most of the animators were drawing using the old cartoon formula of standardized shapes, sizes, actions, and gestures, with little or no reference to nature. [12] Out of these classes grew a way of drawing moving human figures and animals. The students studied models in motion [20] as well as live action film, playing certain actions over and over. [13] The analysis of action became important to the development of animation.

Some of the animators began to apply the lessons of these classes to production animation, which became more sophisticated and realistic. The animators continually searched for better ways to communicate to one another the ideas learned from these lessons. Gradually, procedures were isolated and named, analyzed and perfected, and new artists were taught these practices as rules of the trade. [26] They became the fundamental principles of traditional animation:

1. *Squash and Stretch* -- Defining the rigidity and mass of an object by distorting its shape during an action.
2. *Timing* -- Spacing actions to define the weight and size of objects and the personality of characters.
3. *Anticipation* -- The preparation for an action.
4. *Staging* -- Presentating an idea so that it is unmistakably clear.
5. *Follow Through and Overlapping Action* -- The termination of an action and establishing its relationship to the next action.
6. *Straight Ahead Action and Pose-To-Pose Action* -- The two contrasting approaches to the creation of movement.
7. *Slow In and Out* -- The spacing of the inbetween frames to achieve subtlety of timing and movement.
8. *Arcs* -- The visual path of action for natural movement.
9. *Exaggeration* -- Accentuating the essence of an idea via the design and the action.
10. *Secondary Action* -- The action of an object resulting from another action.
11. *Appeal* -- Creating a design or an action that the audience enjoys watching.

The application of some of these principles mean the same regardless of the medium of animation. 2D hand drawn animation deals with a sequence of two dimensional drawings that simulate motion. 3D computer animation involves creating a three dimensional model in the computer. Motion is achieved by setting keyframe poses and having the computer generate the inbetween frames. Timing, anticipation, staging, follow through, overlap, exaggeration, and secondary action apply in the same way for both types of animation. While the meanings of squash and stretch, slow in and out, arcs, appeal, straight ahead action, and pose-to-pose action remain the same, their application changes due to the difference in medium.

## 2.1 SQUASH AND STRETCH

The most important principle is called *squash and stretch*. When an object is moved, the movement emphasizes any rigidity in the object. In real life, only the most rigid shapes (such as chairs, dishes and pans) remain so during motion. Anything composed of living flesh, no matter how bony, will show considerable movement in its shape during an action. For example, when a bent arm with swelling biceps straightens out, only the long sinews are apparent. A face, whether chewing, smiling, talking, or just showing a change of expression, is alive with changing shapes in the cheeks, the lips, and the eyes. [26]

The squashed position depicts the form either flattened out by an external pressure or constricted by its own power. The stretched position always shows the same form in a very extended condition. [26]

The most important rule to squash and stretch is that, no matter how squashed or stretched out a particular object gets, its volume remains constant. If an object squashed down without its sides stretching, it would appear to shrink; if it stretched up without its sides squeezing in it would appear to grow. Consider the shape and volume of a half filled flour sack: when dropped on the floor, it squashed out to its fullest shape. If picked up by the top corners, it stretched out to its longest shape. It never changes volume. [26]

The standard animation test for all beginners is drawing a bouncing ball. The assignment is to represent the ball by a simple circle, and then have it drop, hit the ground, and bounce back into the air. A simple test, but it teaches the basic mechanics of animating a scene, introducing timing as well as squash and stretch. If the bottom drawing is flattened, it gives the appearance of bouncing. Elongating the drawings before and after the bounce increases the sense of speed, makes it easier to follow and gives more snap to the action. [26,3] (figure 2)

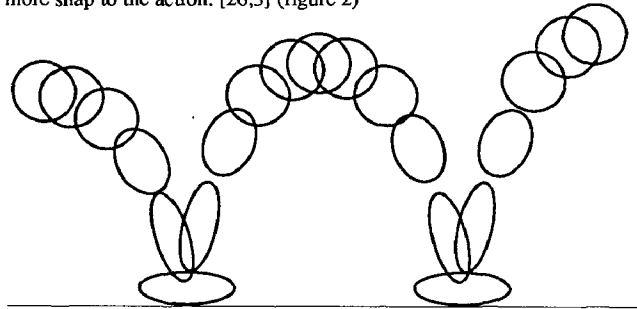

FIGURE 2. Squash & stretch in bouncing ball.

Squash and stretch also defines the rigidity of the material making up an object. When an object is squashed flat and stretches out drastically, it gives the sense that the object is made out of a soft, pliable material and vice versa. When the parts of an object are of different materials, they should respond differently: flexible parts should squash more and rigid parts less.

An object need not deform in order to squash and stretch. For instance, a hinged object like Luxo Jr. (from the film, *Luxo Jr.* [21]), squashes by folding over on itself, and stretches by extending out fully. (figure 3)

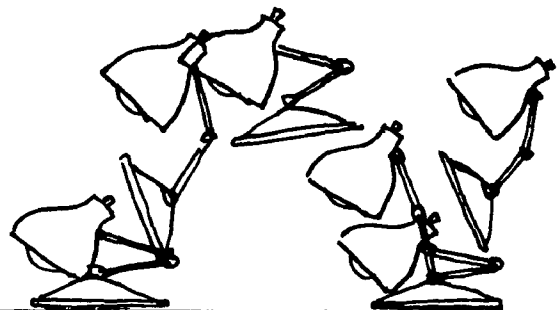

FIGURE 3. Squash & stretch in Luxo Jr.'s hop.

Squash and stretch is very important in facial animation, not only for showing the flexibility of the flesh and muscle, but also for showing the relationship of between the parts of the face. When a face smiles broadly, the corners of the mouth push up into the cheeks. The cheeks squash and push up into the eyes, making the eyes squint, which brings down the eyebrows and stretches the forehead. When the face adopts a surprised expression, the mouth opens, stretching down the cheeks. The wide open eyes push the eyebrows up, squashing and wrinkling the forehead.

Another use of squash and stretch is to help relieve the disturbing effect of strobing that happens with very fast motion because sequential positions of an object become spaced far apart. When the action is slow enough, the object's positions overlap, and the eye smooths the motion out. (figure 4a) However, as the speed of the action increases, so does the distance between positions. When the distance becomes far enough that the object does not overlap from frame to frame, the eye then begins to perceive separate images. (figure 4b) Accurate motion blur is the most realistic solution to this problem of strobing, [8,9] but when motion blur is not available, squash and stretch is an alternative: the object should be stretched enough so that its positions do overlap from frame to frame (or nearly so), and the eye will smooth the action out again. (figure 4c)

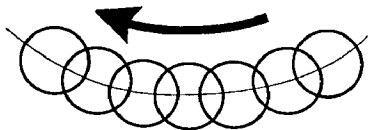

FIGURE 4a. In slow action, an object's position overlaps from frame to frame which gives the action a smooth appearance to the eye.

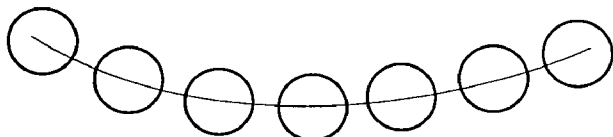

FIGURE 4b. Strobing occurs in a faster action when the object's positions do not overlap and the eye perceives separate images.

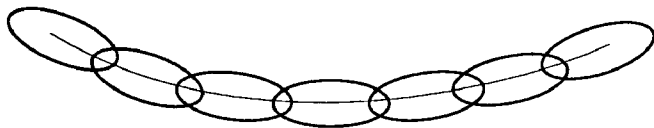

FIGURE 4c. Stretching the object so that its positions overlap again will relieve the strobing effect.

In 3D keyframe computer animation, the scale transformation can be used for squash and stretch. When scaling up in Z, the object should be scaled down in X and Y to keep the volume the same. Since the direction of the stretch should be along the path of action, a rotational transformation may be required to align the object along an appropriate axis.

## 2.2 TIMING

*Timing*, or the speed of an action, is an important principle because it gives meaning to movement-- the speed of an action defines how well the idea behind the action will read to an audience. It reflects the weight and size of an object, and can even carry emotional meaning.

Proper timing is critical to making ideas readable. It is important to spend enough time (but no more) preparing the audience for: the anticipation of an action; the action itself; and the reaction to the action. If too much time is spent on any of these, the audience's attention will wander. If too little time is spent, the movement may be finished before the audience notices it, thus wasting the idea. [30]

The faster the movement, the more important it is to make sure the audience can follow what is happening. The action must not be so fast that the audience cannot read it and understand the meaning of it. [30]

More than any other principle, timing defines the weight of an object. Two objects, identical in size and shape, can appear to be two vastly different weights by manipulating timing alone. The heavier an object is, the greater its mass, and the more force is required to change its motion. A heavy body is slower to accelerate and decelerate than a light one. It takes a large force to get a cannonball moving, but once moving, it tends to keep moving at the same speed and requires some force to stop it. When dealing with heavy objects, one must allow plenty of time and force to start, stop or change their movements, in order to make their weight look convincing. [30]

Light objects have much less resistance to change of movement and so need much less time to start moving. The flick of a finger is enough to make a balloon accelerate quickly away. When moving, it has little momentum and even the friction of the air quickly slows it up. [30]

Timing can also contribute greatly to the feeling of size or scale of an object or character. A giant has much more weight, more mass, more inertia than a normal man; therefore he moves more slowly. Like the cannonball, he takes more time to get started and, once moving, takes more time to stop. Any changes of movement take place more slowly. Conversely, a tiny character has less inertia than normal, so his movements tend to be quicker. [30]

The way an object behaves on the screen, the effect of weight that it gives, depend entirely on the spacing of the poses and not on the poses themselves. No matter how well rendered a cannonball may be, it does not look like a cannonball if it does not behave like one when animated. The same applies to any object or character. [30]

The emotional state of a character can also be defined more by its movement than by its appearance, and the varying speed of those movements indicates whether the character is lethargic, excited, nervous or relaxed. Thomas and Johnston [26] describe how changing the timing of an action gives it new meaning:

*Just two drawings of a head, the first showing it leaning toward the right shoulder and the second with it over on the left and its chin slightly raised, can be made to communicate a multitude of ideas, depending entirely on the Timing used. Each inbetween drawing added between these two "extremes" gives a new meaning to the action.*

*NO inbetweens..... The Character has been hit by a tremendous force. His head is nearly snapped off.*

*ONE inbetweens..... The Character has been hit by a brick, rolling pin, frying pan.*

*TWO inbetweens..... The Character has a nervous tic, a muscle spasm, an uncontrollable twitch.*

*THREE inbetweens..... The Character is dodging a brick, rolling pin, frying pan.*

*FOUR inbetweens..... The Character is giving a crisp order, "Get going!" "Move it!"*

*FIVE inbetweens..... The Character is more friendly, "Over here." "Come on-hurry!"*

*SIX inbetweens..... The Character sees a good looking girl, or the sports car he has always wanted.*

*SEVEN inbetweens..... The Character tries to get a better look at something.*

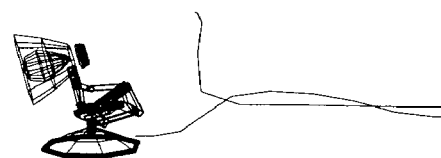
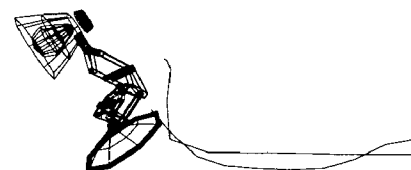

*EIGHT inbetweens..... The Character searches for the peanut butter on the kitchen shelf.*

*NINE inbetweens.....The Character appraises, considering thoughtfully.*

*TEN inbetweens..... The Character stretches a sore muscle.*



FIGURE 5. Wally B.'s zip off shows use of squash and stretch, anticipation, follow through, overlapping action, and secondary action.

### 2.3 ANTICIPATION

An action occurs in three parts: the preparation for the action, the action proper, and the termination of the action. *Anticipation* is the preparation for the action; the latter two are discussed in the next sections.

There are several facets to Anticipation. In one sense, it is the anatomical provision for an action. Since muscles in the body function through contraction, each must be first be extended before it can contract. A foot must be pulled back before it can be swung forward to kick a ball. [12] Without anticipation many actions are abrupt, stiff and unnatural.

Anticipation is also a device to catch the audience's eye, to prepare them for the next movement and lead them to expect it before it actually occurs. Anticipation is often used to explain what the following action is going to be. Before a character reaches to grab an object, he first raises his arms as he stares at the article, broadcasting the fact that he is going to do something with that particular object. The anticipatory moves may not show why he is doing something, but there is no question about what he is going to do next. [26]

Anticipation is also used to direct the attention of the audience to the right part of the screen at the right moment. This is essential for preventing the audience from missing some vital action. In the very beginning of *Luxo Jr.*, Dad is on screen alone looking offstage. He then reacts, anticipating something happening there. When Jr. does hop in, the audience is prepared for the action.

The amount of anticipation used considerably affects the speed of the action which follows it. If the audience expects something to happen, then it can be much faster without losing them. If they are not properly prepared for a very fast action, they may miss it completely; the anticipation must be made larger or the action slower. [30] In a slow action the anticipation is often minimized and the meaning carried in the action proper. [12] In one shot in *The Adventures of Andre and Wally B.*, Wally B. zips off to the right. The actual action of the zip off is only 3 or 4 frames long, but he anticipates the zip long enough for the audience to know exactly what is coming next. (figure 5)

Anticipation can also emphasize heavy weight, as for a character picking up an object that is very heavy. An exaggerated anticipation, like bending way down before picking up the object, helps the momentum of the character to lift the heavy weight. Likewise for a fat character standing up from a seated position: he will bend his upper body forward, with his hands on the armrests of the chair, before pushing up with his arms and using the momentum of his body. [31]

### 2.4 STAGING

*Staging* is the presentation of an idea so it is completely and unmistakably clear; this principle translates directly from 2-D hand drawn animation. An action is staged so that it is understood; a personality is staged so that it is recognizable; an expression so that it can be seen; a mood so that it will affect the audience. [26]

To stage an idea clearly, the audience's eye must be led to exactly where it needs to be at the right moment, so that they will not miss the idea. Staging, anticipation and timing are all integral to directing the eye. A well-timed anticipation will be wasted if it is not staged clearly.

It is important, when staging an action, that only one idea be seen by the audience at a time. If a lot of action is happening at once, the eye does not know where to look and the main idea of the action will be "upstaged" and overlooked. The object of interest should contrast from the rest of the scene. In a still scene, the eye will be attracted to movement. In a very busy scene, the eye will be attracted to something that is still. Each idea or action must be staged in the strongest and the simplest way before going on to the next idea or action. The animator is saying, in effect, "Look at this, now look at this, and now look at this." [26]

In *Luxo Jr.*, it was very important that the audience was looking in the right place at the right time, because the story, acting and emotion was being put across with movement alone, in pantomime, and sometimes the movement was very subtle. If the audience missed an action, an emotion would be missed, and the story would suffer. So the action had to be paced so that only Dad or Jr. was doing an important action at any one time, never both. In the beginning of the film, Dad is on screen alone your eye was on him. But as soon as Jr. hops on-screen, he is moving faster than Dad, therefore the audience's eyes immediately goes to him and stays there.

Most of the time Jr. was on-screen, Dad's actions were very subtle, so the attention of the audience was always on Jr. where most of the story was being told. If Dad's actions were important, Jr.'s actions were toned down and Dad's movements were emphasized and the attention of the audience would transfer to Dad. For example, when Jr. looks up to Dad after he's popped the ball and Dad shakes his head, all eyes are on him.

Another idea developed in the early days at Disney was the importance of staging an action in silhouette. In those days, all the characters were black and white, with no gray values to soften the contrast or delineate a form. Bodies, arms and hands were all black, so there was no way to stage an action clearly except in silhouette. A hand in front of a chest would simply disappear. Out of this limitation, the animators realized that it is always better to show an action in silhouette. Charlie Chaplin maintained that if an actor knew his emotion thoroughly, he could show it silhouette. [26]

In *The Adventures of Andre and Wally B.*, Andre awakes and sits up, then scratches his side. If he were to scratch his stomach instead of his side, the action would happen in front of his body and would be unclear what was happening. (figure 6)

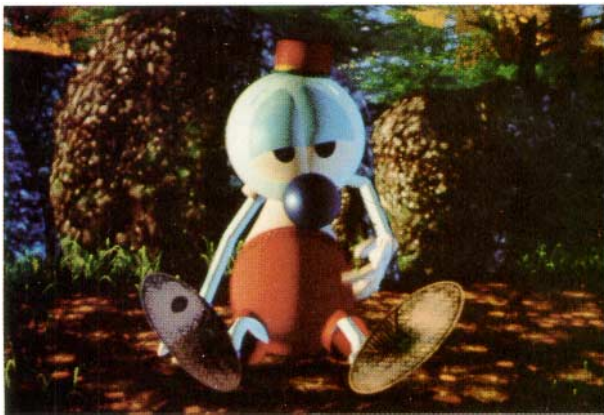

FIGURE 6. Andre's scratch was staged to the side (in "silhouette") for clarity and because that is where his itch was.

In *Luxo Jr.*, all the action was animated with silhouette in mind. When Dad and Jr. come face to face for the first time, it is easy to see what is happening because it is staged to the side. If Jr. was in front of Dad looking up at him, it would be difficult to read. (figure 7) Jr. hopping on the ball would be confusing if the action was to happen with Jr. facing the camera. Viewed from the side it is perfectly clear. (figure 8)

## 2.5 FOLLOW THROUGH AND OVERLAPPING ACTION

Just as the anticipation is the preparation of an action, *follow through* is the termination of an action. Actions very rarely come to a sudden and complete stop, but are generally carried past their termination point. For example, a hand, after releasing a thrown ball, continues past the actual point of release.

In the movement of any object or figure, the actions of the parts are not simultaneous: some part must initiate the move, like the engine of a train. This is called the *lead*. In walking, the action starts with the hips. As the hip swings forward, it sets a leg in motion. The hip "leads", the leg

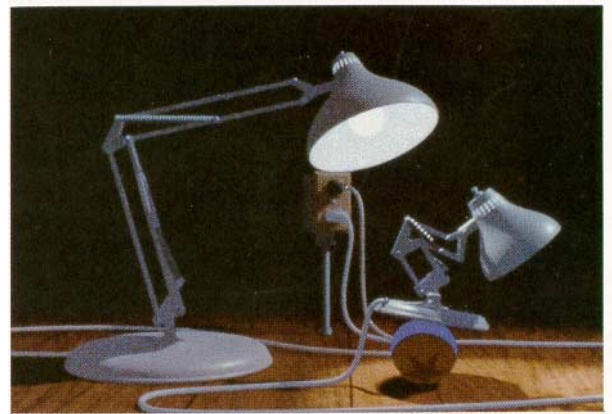

FIGURES 7-8. In *Luxo Jr.*, all action was staged to the side for clarity.

"follows." As the hip twists, the torso follows, then the shoulder, the arm, the wrist, and finally the fingers. Although most large body actions start in the hips, the wrist will lead the fingers in a hand gesture, and the eyes will usually lead the head in an action. [12]

Appendages or loose parts of a character or object will move at a slower speed and "drag" behind the leading part of the figure. Then as the leading part of the figure slows to a stop, these appendages will continue to move and will take longer to settle down. As with squash and stretch, the object's mass is shown in the way the object slows down. The degree that the appendages drag behind and the time it takes for them to stop is directly proportional to their weight. The heavier they are the farther behind they drag and the longer they take to settle to a stop. Conversely, if they are lighter, they will drag less and stop more quickly.

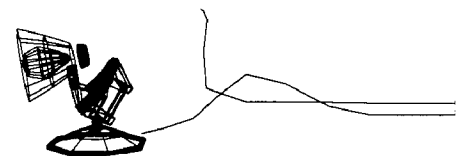
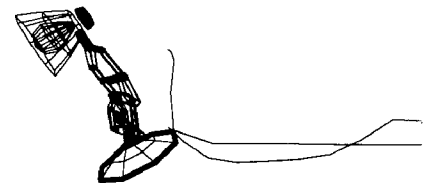

In *The Adventures of Andre and Wally B.*, this principle was used extensively on Wally B.'s feet, antennae and stinger. They all dragged behind his head and body, and continued to move well after the body had stopped. To convey that these loose appendages were made of different materials and different masses, the rate of the follow through was different for each type. His antennae were fairly light, so they dragged behind just slightly. His stinger was like stainless steel, so it dragged behind the action more than the antennae. And his feet were heavy and very flexible, as though they were water balloons; therefore, they always followed far behind the main action with a lot of squash and stretch. In the zip off illustrated above (figure 5), the action of Wally B.'s body was so fast and the feet weighed so much that they dragged far behind. They were even left on screen frames after the body had disappeared.

Often, slight variations are added to the timing and speed of the loose parts of objects. This *overlapping action* makes the object seem natural, the action more interesting. In Wally's zip off (figure 5), his feet zipped off, one after the other, about one or two frames apart. The action was so fast that it was difficult to see each foot going off separately, but it made the action as a whole more interesting.

Perhaps more important, overlapping is critical to conveying main ideas of the story. An action should never be brought to a complete stop before starting another action, and the second action should overlap the first. Overlapping maintains a continual flow and continuity between whole phrases of actions.

Walt Disney once explained overlapping this way, "It is not necessary for an animator to take a character to one point, complete that action completely, and then turn to the following action as if he had never given it a thought until after completing the first action. When a character knows what his is going to do he doesn't have to stop before each individual action and think to do it. He has it planned in advance in his mind. For example, the mind thinks, 'I'll close the door - lock it - then I'm going to undress and go to bed.' Well, you walk over to the door - before the door is finished you're reaching for the door - before the door is closed you reach for the key - before the door is locked you're turning away - while you're walking away you undo your tie - and before you reach the bureau you have your tie off. In other words, before you know it you're undressed - and you've done it in one thought, 'I'm going to bed.'" [12]

## 2.6 STRAIGHT AHEAD ACTION AND POSE-TO-POSE ACTION (KEYFRAMES)

There are two main approaches to hand drawn animation. The first is known as *straight ahead action* because the animator literally works straight ahead from his first drawing in the scene. He knows where the scene fits in the story and the business it has to include. He does one drawing after another, getting new ideas as he goes along, until he reaches the end of the scene. This process usually produces drawings and action that have a fresh and slightly zany look, because the whole process was kept very creative. Straight ahead action is used for wild, scrambling actions where spontaneity is important.

The second approach is called *pose-to-pose*. Here the animator plans his actions, figures out just what drawings will be needed to animate the business, makes the drawings concentrating on the poses, relates them to each other in size and action, and then draws the inbetweens. Pose-to-pose is used for animation that requires good acting, where the poses and timing are all important.

The pose-to-pose technique applies to keyframe computer animation with timing and pose control of extremes and inbetweens. The difficulty in controlling the inbetweens makes it incorrect to approach keyframe computer animation exactly as one would pose-to-pose hand drawn animation. In working with a complex model, creating a complete pose at a time would make the inbetweens too unpredictable. The path of action will in general be incorrect and objects will intersect one another. The result is much time-consuming reworking of inbetweens.

There is a much better approach in the context of a hierarchical modelling system, which works "layer by layer" down the hierarchy. Instead of animating one complete pose to another, one transformation is animated at a time, starting with the trunk of the hierarchical tree structure, working transformation by transformation down the branches to the end. Fewer extremes are used. Not all translates, rotates and scales have extremes on the same frames; some have many extremes and others very few. With fewer extremes, the importance of the inbetweens increases. Tension and direction controls on the interpolating splines are helpful in controlling the spacing of the inbetween and to achieve slow in and out. [16] (See Slow In and Out)

This layer approach to animation shares many important elements with the pose-to-pose technique in hand drawn animation. Planning the animation out in advance, as in pose-to-pose, becomes even more important. The action must be well thought out, the timing and poses planned so that even in the early layers, the poses and actions are clear.

*The Adventures of Andre and Wally B.* and *Luxo Jr.* were both animated using a keyframe animation system called Md (Motion Doctor). [19] *Luxo Jr.* was animated using this layered approach to the keyframes. Jr.'s hop (figure 1) was animated by first setting the keyframes for his forward movement only: two keyframes were set for the X translation, the first where the hop starts and the second where he lands. This defined the timing of his hop. The height of his hop was then defined by setting a keyframe in the Z translation (Z being up in this case). The next step, animating the rotation of Jr.'s arms, was important because the arms define the anticipation, squash and stretch, and follow through of the action. Keyframes were set for just about every frame, rotating the arms together before the hop for the anticipation, then immediately far apart for the stretch of the jump. The arms were rotated together again at the top of the arc where the action slows slightly, then rotated far apart, stretching to anticipate the landing. To indicate the shock of the landing, the arms were rotated quickly together two frames after the base lands on the floor. This is the follow through of the action. His base and shade were animated in the next two steps. Like the arms, many keyframes were set to define the rotation of the base and shade because their movement was important for anticipation and follow through.

## 2.7 SLOW IN AND OUT

*Slow in and slow out* deals with the spacing of the inbetween drawings between the extreme poses. Mathematically, the term refers to second- and third-order continuity of motion.

In early animation, the action was limited to mainly fast and slow moves, the spacing from one drawing to the next fairly even. But when the poses of pose-to-pose animation became more expressive, animators wanted the audience to see them. They found that by grouping the inbetweens closer to each extreme, with only one fleeting drawing halfway between, they could achieve a very spirited result, with the character zipping from one attitude to another. "Slowing out" of one pose, then "slowing in" to the next pose simply refers to the timing of the inbetweens.

The animator indicates the placement of the inbetweens, the slow in or slow out, with a "timing chart" drawn on the side of the drawing. This tells himself, or his assistant who will be doing the inbetweens later, how he wanted the timing to be and where he wanted the inbetween drawings placed. (figure 9)

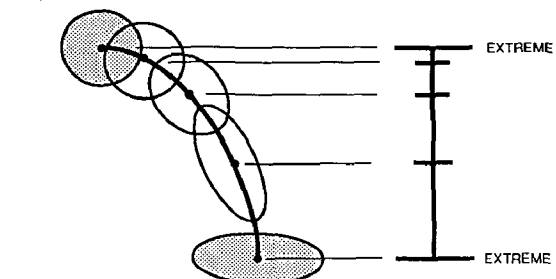

FIGURE 9. Timing chart for ball bounce.

In most 3D keyframe computer animation systems, the inbetweening is done automatically using spline interpolation. Slow in and slow out is achieved by adjusting the tension, direction or bias, and continuity of the splines. [16] This works well to give the affect of slow in and out, but a graphical representation of the spline is required to see the effect of tension, direction, and continuity have on its shape.

With this type of spline interpolation, a common problem is the spline overshooting at extremes when there is a large change in value between them, especially over a small number of frames. This also happens when the direction control of an extreme is adjusted. The danger is that, depending on the variable the spline controls (translate, rotate, or scale), the value will shoot in the wrong direction just before (or just after) the large change in value. Sometimes this effect works out well when it occurs just before a large movement, it may appear to be an anticipation. However, more often than not, it gives an undesirable effect.

In *Luxo Jr.*, there was an example of this problem of overshooting splines. Jr.'s base was very heavy and when he hopped, we wanted the base to start stationary, then pop up in the air from the momentum of his jump, arc over, then land with a thud, suddenly stationary again. For the up translation, there were three keyframes, the two stationary positions and the highest point of his jump. The spline software forced continuity, so that his base would move down under the surface of the floor just before and after the jump. (figure 10a) The solution was to put two new extremes, equal to the two stationary extremes, on the frames just before and just after the extremes. This "locked" down the spline, so that the up translation stayed the same value, popped up in the air, landed and then stayed the same value again. This gave the desired feeling of weight to his little base. (figure 10b)

The same solution can be achieved by breaking the spline using its continuity parameter [16] at the two stationary extremes. This solution requires a graphical display of the spline so that the correct shape can be achieved.

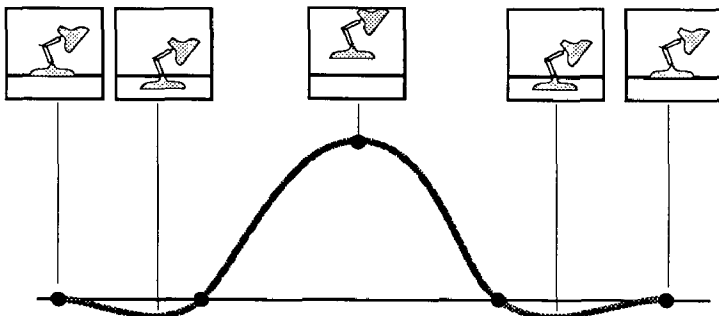

FIGURE 10a. This spline controls the Z (up) translation of Luxo Jr. Dips in the spline cause him to intersect the floor.

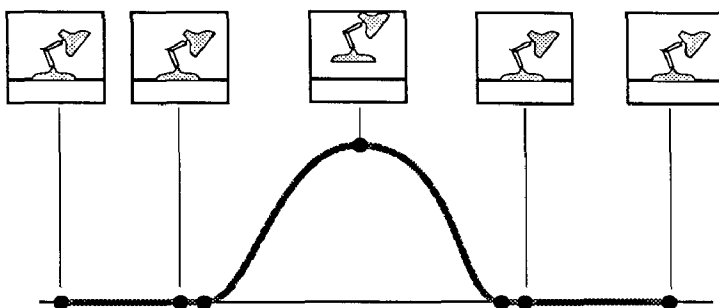

FIGURE 10b. Two extra extremes are added to the spline which removes the dips and prevents Jr. from going into the basement.

## 2.8 ARCS

The visual path of action from one extreme to another is always described by an *arc*. Arcs in nature are the most economical routes by which a form can move from one position to another. In animation, such arcs are used extensively, for they make animation much smoother and less stiff than a straight line for the path of action. In certain cases, an arc may resolve itself into a straight path, as for a falling object, but usually, even in a straight line action, the object rotates. [12]

In most 3D keyframe computer animation systems, the path of action from one extreme to another is controlled by the same spline that controls the timing (slow in and out) of the inbetween values. This may simplify computing the inbetweens but it has unfortunate effects. When a motion is slow, with many inbetweens, the arc of the path of action is curved, as desired. But when the action is fast, the arc flattens out: the faster the action, the flatter the arc. Sometimes this is desirable, but more often, the path of even a fast motion should be curved or arced. Straight inbetweens can completely kill the essence of an action.

The spline that defines the path of action should be separate from the spline that defines the timing or spacing of the inbetweens for several reasons: so that the arc of a fast action doesn't flatten out; so that you can adjust the timing of the inbetweens without effecting the path of action; so that you can use different splines to define the path of action (where a B-spline is appropriate for its smoothness) and the timing (a Catmull - Rom spline so you can adjust it's tension and direction controls to get slow in and out). This technique is not common, but research is being done in this area. [15]

## 2.9 EXAGGERATION

The meaning of exaggeration is, in general, obvious. However, the principle of *exaggeration* in animation does not mean arbitrarily distorting shapes or objects or making an action more violent or unrealistic. The animator must go to the heart of anything or any idea and develop its essence, understanding the reason for it, so that the audience will also understand it. If a character is sad, make him sadder; if he is bright, make him shine; worried, make him fret; wild, make him frantic.

A scene has many components to it: the design, the shape of the objects, the action, the emotion, the color, the sound. Exaggeration can work with any component, but not in isolation. The exaggeration of the various components should be balanced. If just one thing is exaggerated in an otherwise lifelike scene, it will stick out and seem unrealistic.

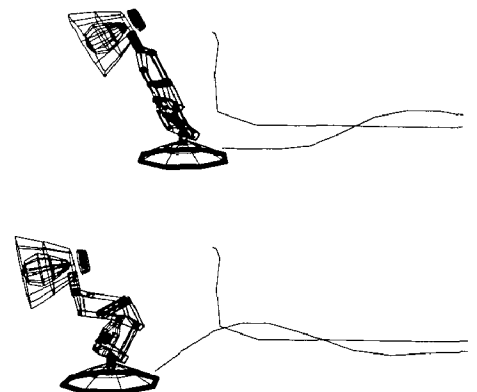

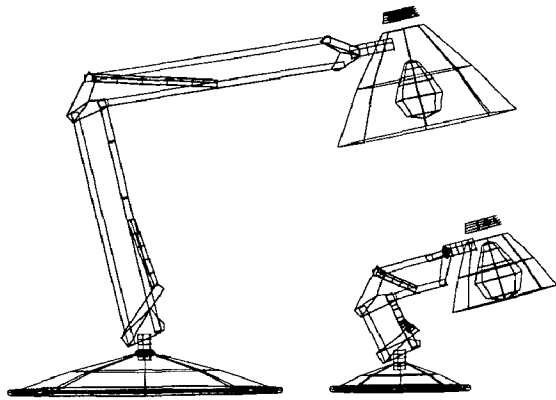

FIGURE 11. Varying the scale of different parts of Dad created the child-like proportions of Luxo Jr.

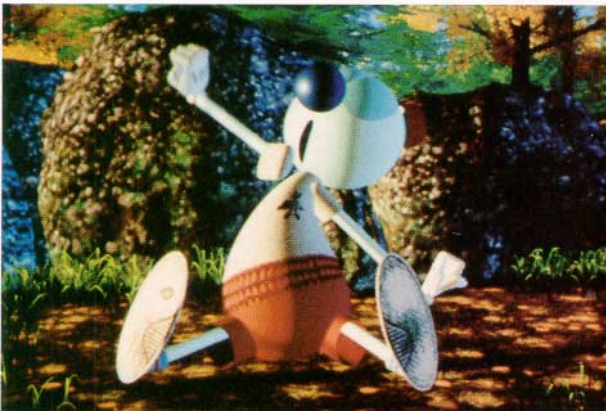
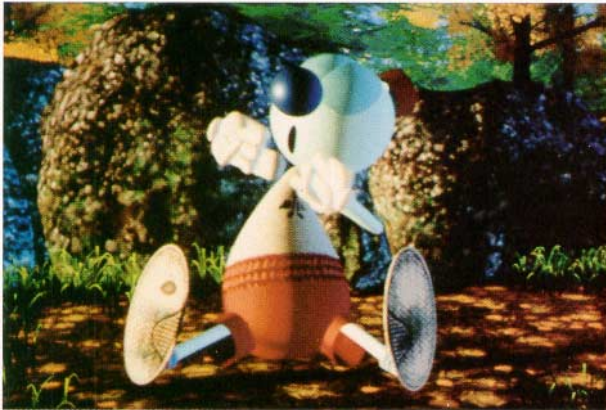

FIGURE 12. Andre's yawn was made more interesting by not duplicating the poses and the action from one side of his body to the other.

However, exaggerating everything in a scene can be equally unrealistic to an audience. Some elements must be based in nature, with others exaggerated unnaturally. If there is an element that the audience can recognize, something that seems natural to them, that becomes the ground for comparison of the exaggeration of the other elements, and the whole scene remains very realistic to them.

In *Luxo Jr.*, all the components of the scene, some naturalistic, some exaggerated, worked together to make it believable and realistic. The design

of the lamps was based on the real Luxo lamp, but certain parts were exaggerated. Jr.'s proportions were exaggerated to give the feeling of a child (See Appeal).

The movement had the sense of natural physics, yet almost every motion and action was exaggerated to accentuate it: when Jr. he hit the ball, he really whacked it. When he jumped up for a hop, his whole body movement was exaggerated to give the feeling of realistic weight to his base. When he landed after a hop, the impact was shown in the exaggeration of his body movements. On the soundtrack, the lamp sounds were recorded from a real Luxo lamp, then exaggerated sounds were added to accent certain actions. [23] The ironic effect of all this exaggeration was to make the film more realistic, while making it entertaining.

## 2.10 SECONDARY ACTION

A *secondary action* is an action that results directly from another action. Secondary actions are important in heightening interest and adding a realistic complexity to the animation. A secondary actions is always kept subordinate to the primary action. If it conflicts, becomes more interesting, or dominates in any way, it is either the wrong choice or is staged improperly. [26]

Wally B.'s feet dragging behind the main action of his body is a secondary action because the movement of the feet is a direct result of the movement of the body. (figure 5) The rippling movement of Luxo Jr.'s cord results directly from the hopping action of his base. (figure 1)

The facial expression of a character will sometimes be a secondary action. When the main idea of an action is being told in the movement of the body, the facial expression become subordinate to the main idea. If this expression is going to animate or change, the danger is not that the expression will dominate the scene, but that it will never be seen. The change must come before, or after, the move. A change in the middle of a major move will go unnoticed, and value intended will be lost. It must also be staged to be obvious, though secondary. [26]

## 2.11 APPEAL

The word *appeal* is often misrepresented to suggest cuddly bunnies and soft kittens. It doesn't; it means anything that a person likes to see: a quality of charm, pleasing design, simplicity, communication, or magnetism. Your eye is drawn to the figure or object that has appeal, and, once there, it is held while you appreciate the object. A weak drawing or design lacks appeal. A design that is complicated or hard to read lacks appeal. Clumsy shapes and awkward moves all have low appeal. Where the live action actor has charisma, the animated character has appeal. [26]

The appeal in *Luxo Jr.* was achieved in different ways. In designing the characters, the feeling of a baby lamp and a grown up lamp was very important. The effect was achieved using exaggeration in proportion, in the same way a puppy is proportioned very differently than an adult dog, or a human baby is different from an adult. The light bulb is the same size on Jr., while the shade is smaller. The springs and support rods are the same diameter as Dad's, yet they are much shorter. (figure 11)

In creating an appealing pose for a character, one thing to avoid is called "twins", where both arms and both legs are in the same position, doing the same thing. This gives the pose a stiff, wooden, unappealing quality. If each part of the body varies in some way from its corresponding part, the character will look more natural and more appealing. Likewise one side of a face should never mirror the other.

In *The Adventures of Andre and Wally B.*, Andre wakes up and yawns. The yawn is more appealing because the poses and actions are not duplicated from one side of his body to the other. His feet rotate with a slight difference, the head rotates to one side, the upper part of his body rotates to the right and tilts, which raises his right arm higher than his left. When he stretches his arms, the right arm moves out first, followed by the left, and the actions overlap. (figure 12)



### 3. PERSONALITY

This final section discusses the underlying goal of all the principles discussed earlier. *Personality* in character animation is not a principle unto itself, but the intelligent application of all of the principles of animation.

When character animation is successful and the audience is thoroughly entertained, it is because the characters and the story have become more important and apparent than the technique that went into the animation. Whether drawn by hand or computer, the success of character animation lies in the *personality* of the characters

In character animation, all actions and movements of a character are the result of its thought processes. "The thinking animation character *becomes* a character." [12] Without a thought process, the actions of a character are just a series of unrelated motions. With a thought process to connect them, the actions bring a character to life.

In order to get a thought process into an animation, it is critical to have the personality of a character clearly in mind at the outset, so that it makes sense to ask at any moment, "What mood is the character in. How would he do this action?"

One character would not do a particular action the same way in two different emotional states. An example of this, in *Luxo Jr.*, is the action of Jr. hopping. When he is chasing the ball, he is very excited, happy, all his thoughts on the ball. His hops are fast, his head up looking at the ball, with very little time on the ground between hops because he can't wait to get to the ball. After he pops the ball, however, his hop changes drastically, reflecting his sadness that the object of all of his thoughts and energy just a moment ago is now dead. As he hops off, each hop is slower, with much more time on the ground between hops, his head down. Before, he had a direction and purpose to his hop. Now he is just hopping off to nowhere.

No two characters would do the same action in the same way. For example, in *Luxo Jr.*, both Dad and Jr. bat the ball with their heads. Yet Dad, who is larger and older, leans over the ball and uses only his shade to bat it. Jr., however, who is smaller, younger, and full of excited energy, whacks the ball with his shade, putting his whole body into it.

When defining the character, it is important to make the personality distinct, and at the same time have characteristics that are familiar to the audience. If the actions of a character ring true, the audience will be able to relate to the character, and he will be believable to them.

### 4. CONCLUSION

Whether it is generated by hand or by computer, the first goal of the animator is to entertain. The animator must have two things: a clear concept of exactly what will entertain the audience; and the tools and skills to put those ideas across clearly and unambiguously. Tools, in the sense of hardware and software, are simply not enough. The principles discussed in this paper, so useful in producing 50 years of rich entertainment, are tools as well... tools which are just as important as the computers we work with.

### 5. ACKNOWLEDGMENTS

The author would like to express sincere thanks to Bill Reeves and Eben Ostby for their unending support, education and creativity with the technical aspects of computer animation. Steve Upstill for making it sound like I know English. Nancy Tague for her ruthless editing even on my birthday. Kate Smith and Michael Shantzis for their assistance in editing this paper even when they could have been watching Willie Wonka on video tape. Craig Good for helping with the video tape portion of this paper. Joey Tague for being pals and for telling us what happened in Willie Wonka. And especially to Frank Thomas and Ollie Johnston for their instruction in animation when the author was at the Disney Studio, and for their continued inspiration with their book. [26]

### 6. REFERENCES

1. Abel Image Research, 953 N. Highland Ave., Los Angeles, CA 90038-2481
2. Alias Research Inc., 110 Richmond St. East, Suite 500, Toronto, Ontario, Canada m5c-1p1
3. Blair, Preston, *Animation*, Walter T. Foster, Santa Ana CA, 1949.
4. Burtnyk, Nester and Wein, Marcell, "Computer Generated Keyframe Animation," *Journal of the SMPTE* 80, pp.149-153, March 1971.
5. Burtnyk, Nester and Wein, Marcell, "Interactive Skeleton Techniques for Enhanced Motion Dynamics in Key Frame Animation," *Communications of the ACM* 19 (10), pp 564-569, October, 1976.
6. Catmull, Edwin, "A System for Computer Generated Movies," *Proceedings ACM Annual Conference*, pp. 422-431, August 1972.
7. Catmull, Edwin, "The problems of Computer- Assisted Animation," *SIGGRAPH '78, Computer Graphics*, Vol. 12, No. 3, pp. 348-353, August 1978.
8. Cook, Robert L., "Stochastic Sampling in Computer Graphics," *ACM Transactions on Graphics*, Vol. 5, No. 1, pp. 51-72, January 1986.
9. Cook, Robert L., Porter, Thomas, and Carpenter, Loren, "Distributed Ray Tracing," *SIGGRAPH '84, Computer Graphics*, Vol. 18, No. 3, pp.137-145, July, 1984.
10. Walt Disney Productions, *Three Little Pigs*, (film), 1933.
11. Gracer, F., and Blagen, M. W., "Karma: A System for Storyboard Animation," *Proceeding Ninth Annual UAIDE Meeting*, pp. 210-255, 1970.
12. Graham, Don, *The Art of Animation*, unpublished.
13. Graham, Don, transcripts of action analysis class at the Walt Disney Studio, June 21, 1937.
14. Graham, Don, transcripts of action analysis class with Bill Tylta at the Walt Disney Studio, June 28, 1937.
15. Hardtke, Ines, and Bartels, Richard, "Kinetics for Key-Frame Interpolation," unpublished.
16. Kochanek, Doris, and Bartels, Richard, "Interpolating Splines with Local Tension, Continuity, and Bias Control," *SIGGRAPH '84, Computer Graphics*, Vol. 18, No. 3, pp. 33-41, July, 1984.
17. Levoy, Marc, "A Color Animation System Based on the Multi-Plane Technique," *SIGGRAPH '77, Computer Graphics*, Vol. 11, No. 2, pp. 64-71, July, 1977.

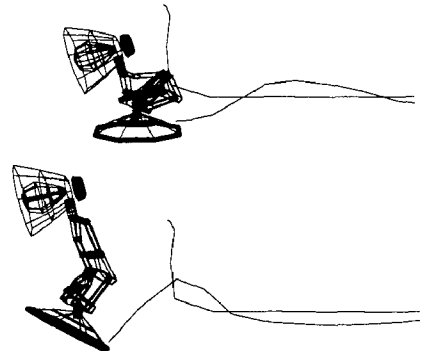



18. Lucasfilm Ltd. Computer Graphics Div., *The Adventures of Andre and Wally B.*, (film), 1984.
19. Ostby, Eben, Duff, Tom, and Reeves, William, Md (motion doctor), animation program, Lucasfilm Ltd., 1982-1986.
20. Perine, Robert, *Chouinard, An Art Vision Betrayed*, Artra Publishing, Encinitas CA, 1985.
21. Pixar, *Luxo Jr.*, (film), 1986.
22. Reeves, William, "Inbetweening for Computer Animation Utilizing Moving Point Constraints," SIGGRAPH '81, Computer Graphics, Vol. 15, No. 3, pp. 263-270, August 1981.
23. Rydstrom, Gary, Soundtrack for *Luxo Jr.*, Sprocket Systems Div., Lucasfilm Ltd., July, 1986.
24. Stern, Garland, "Bboop--A System for 3D Keyframe Figure Animation," Tutorial Notes: Introduction to Computer Animation, SIGGRAPH '83, July 1983.
25. Symbolics Inc., 1401 Westwood Blvd., Los Angeles, CA 90024
26. Thomas, Frank and Johnston, Ollie, *Disney Animation-- The Illusion of Life*, Abbeville Press, New York, 1981.
27. Thomas, Frank, "Can Classic Disney Animation Be Duplicated On The Computer?" Computer Pictures, Vol. 2, Issue 4, pp. 20-26, July/August 1984.
28. Vertigo Systems International Inc., 119 W. Pender St., Suite 221, Vancouver, BC, Canada v6b 1s5
29. Wavefront Technologies, 530 East Montecito, Santa Barbara, CA 93101
30. Whitaker, Harold and Halas, John, *Timing for Animation*, Focal Press, London, 1981.
31. White, Tony, *The Animator's Workbook*, Watson-Guptill, New York, 1986.