

CSE 442 - Data Visualization

Graphical Perception

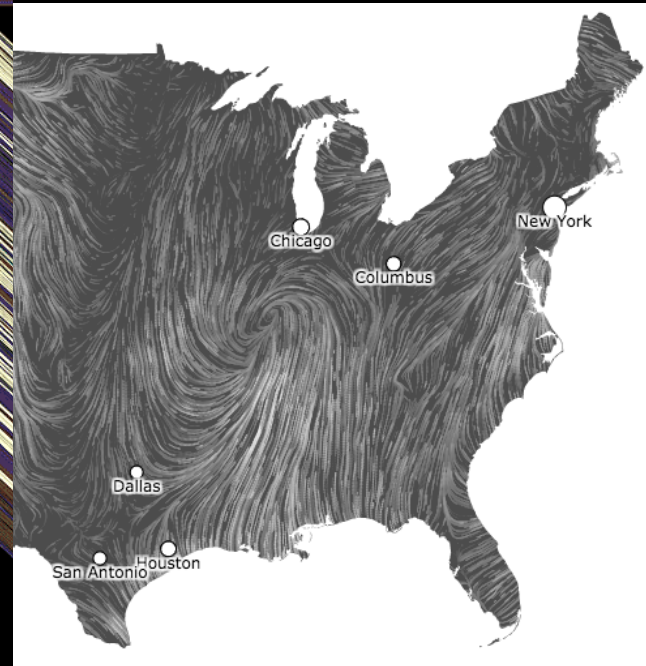
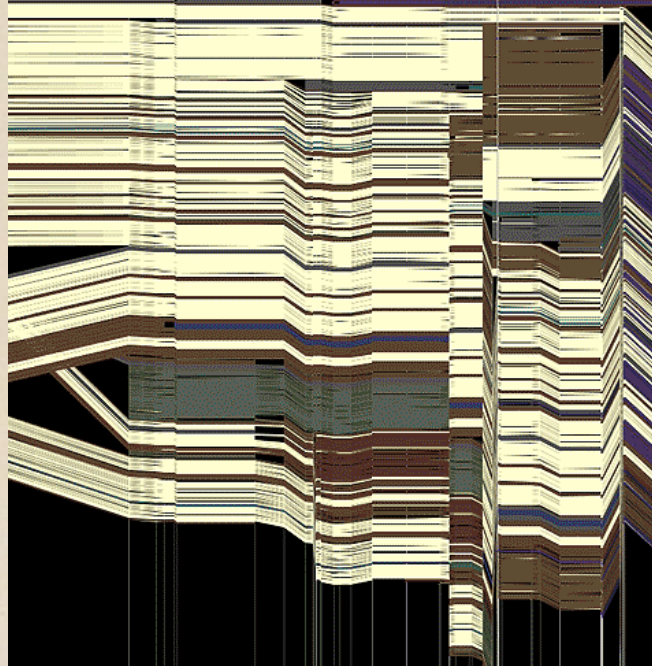
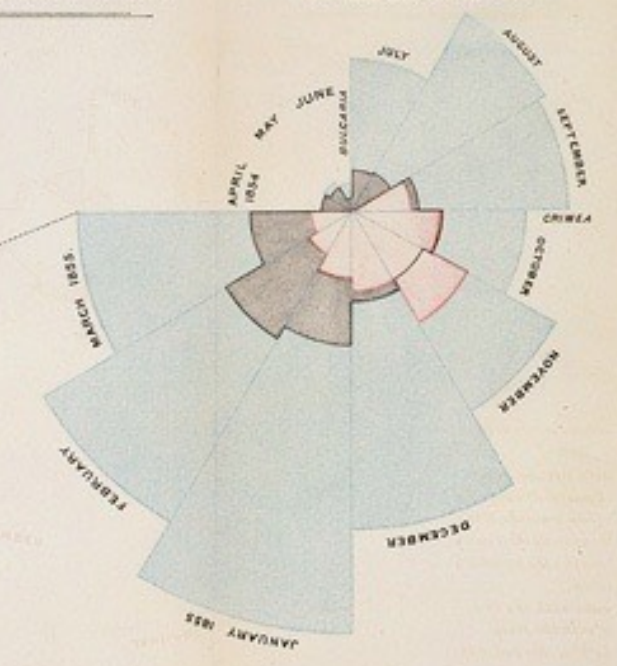

Jeffrey Heer University of Washington

Design Principles [Mackinlay 86]

Expressiveness

A set of facts is *expressible* in a visual language if the sentences (i.e. the visualizations) in the language express all the facts in the set of data, and only the facts in the data.

Effectiveness

A visualization is more *effective* than another visualization if the information conveyed by one visualization is more readily perceived than the information in the other visualization.

Design Principles *Translated*

Tell the truth and nothing but the truth
(don't lie, and don't lie by omission)

Use encodings that people decode better
(where better = faster and/or more accurate)

Effectiveness Rankings [Mackinlay 86]

QUANTITATIVE

Position
Length
Angle
Slope
Area (Size)
Volume
Density (Value)
Color Sat
Color Hue
Texture
Connection
Containment
Shape

ORDINAL

Position
Density (Value)
Color Sat
Color Hue
Texture
Connection
Containment
Length
Angle
Slope
Area (Size)
Volume
Shape

NOMINAL

Position
Color Hue
Texture
Connection
Containment
Density (Value)
Color Sat
Shape
Length
Angle
Slope
Area
Volume

Graphical Perception

The ability of viewers to interpret visual (graphical) encodings of information and thereby decode information in graphs.

Topics

Signal Detection

Magnitude Estimation

Using Multiple Visual Encodings

Pre-Attentive Processing

Gestalt Grouping

Change Blindness

Signal Detection

Detecting Brightness

L



R



Which is brighter?

Detecting Brightness

(128, 128, 128)

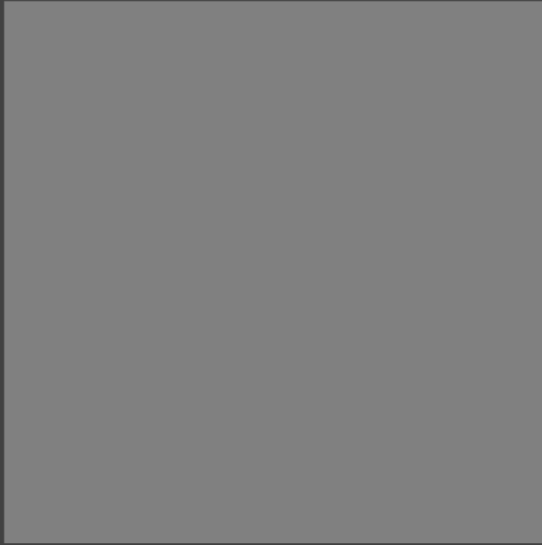

(144, 144, 144)

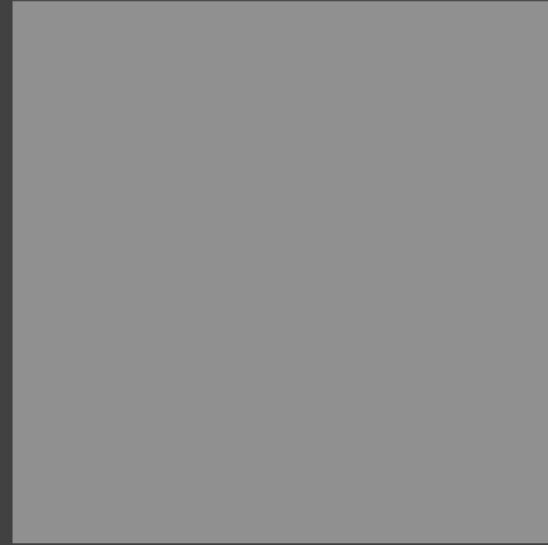

Which is brighter?



Detecting Brightness

L



R



Which is brighter?

Detecting Brightness

(134, 134, 134)

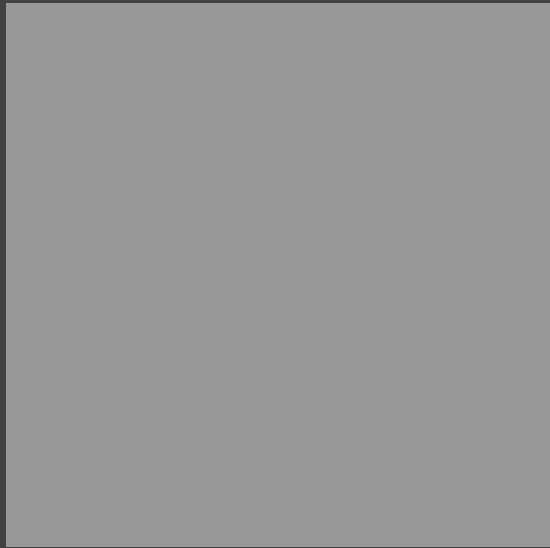

(128, 128, 128)

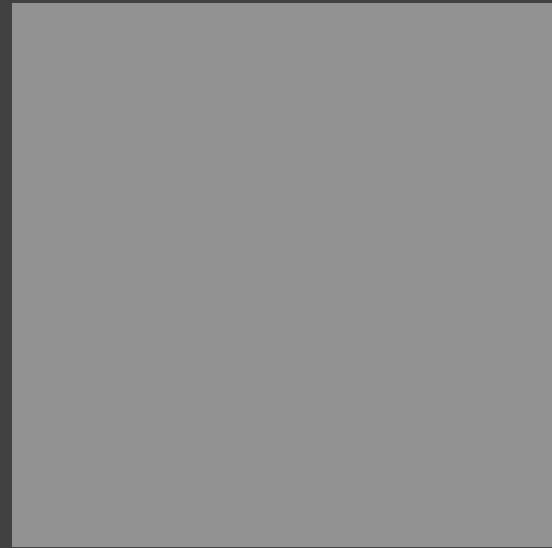

Which is brighter?

Just Noticeable Difference (JND)

JND (Weber's Law)

Perceived
Change →

$$\Delta S = k \frac{\Delta I}{I}$$

Scale Factor
(Empirically Determined)

← Change of
Intensity

← Physical
Intensity

Ratios more important than magnitude

Most continuous variation in stimuli are
perceived in discrete steps



Encoding Data with Color

Value is perceived as ordered

∴ Encode ordinal variables (O)

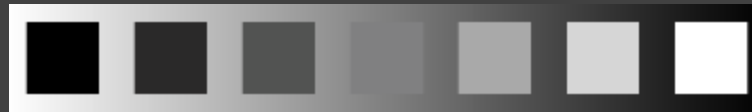

∴ Encode continuous variables (Q) [not as well]

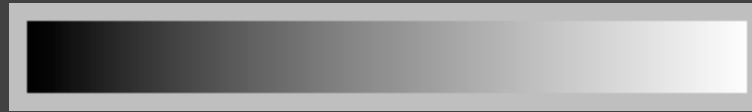

Hue is normally perceived as unordered

∴ Encode nominal variables (N) using color



Steps in Font Size

Sizes standardized in 16th century

a	a	a	a	a	a	a	a	a	a	a	a	a	a	a	a
6	7	8	9	10	11	12	14	16	18	21	24	36	48	60	72

Magnitude Estimation

A Quick Experiment...

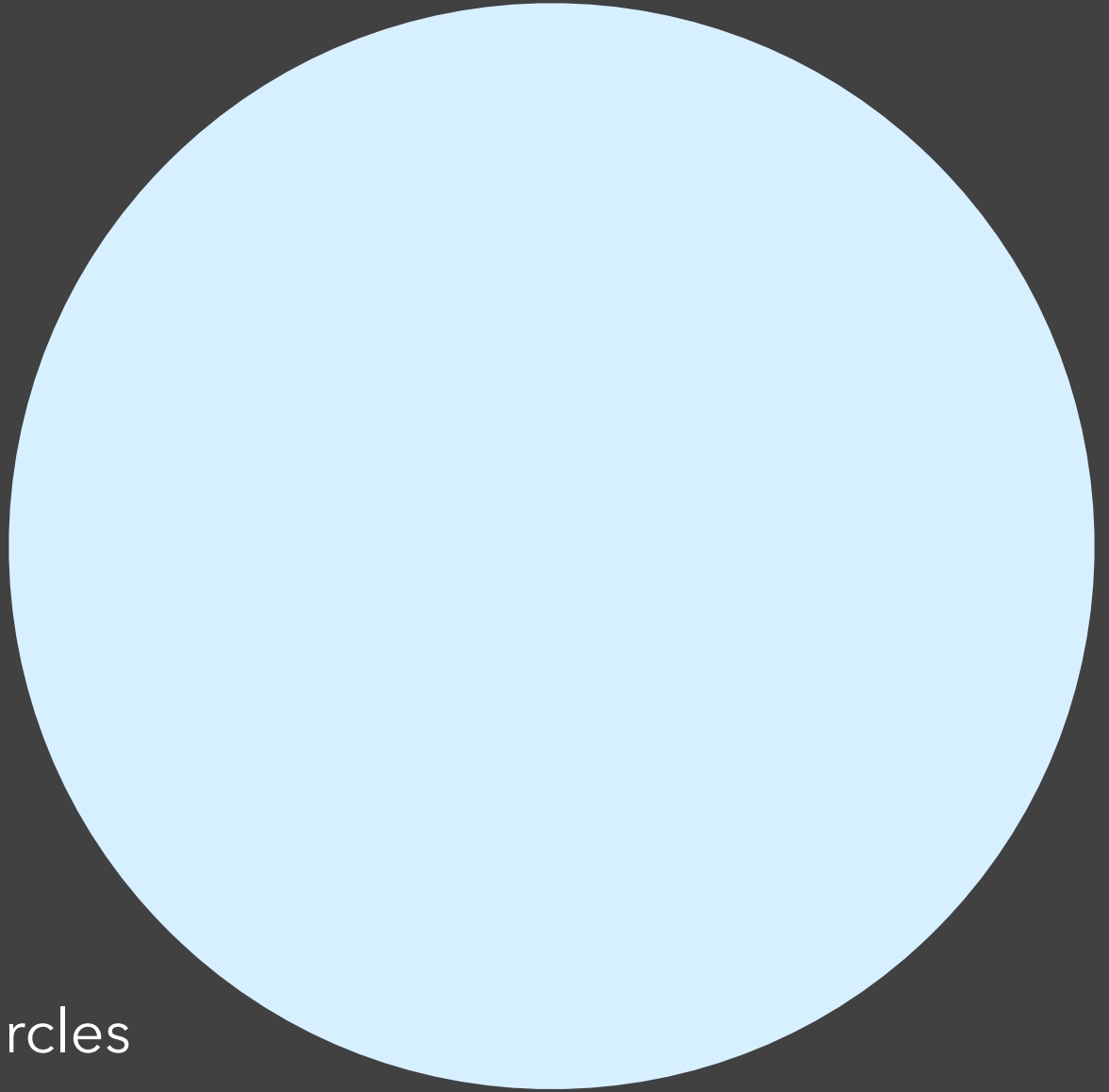
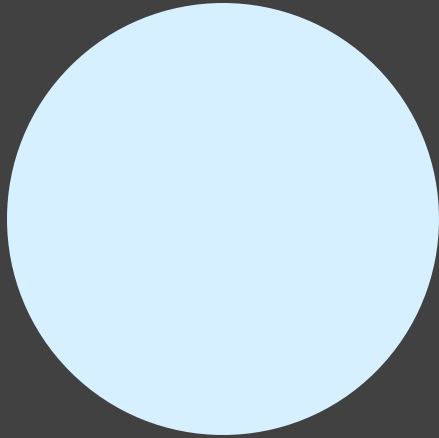

Compare area of circles

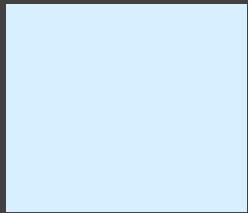
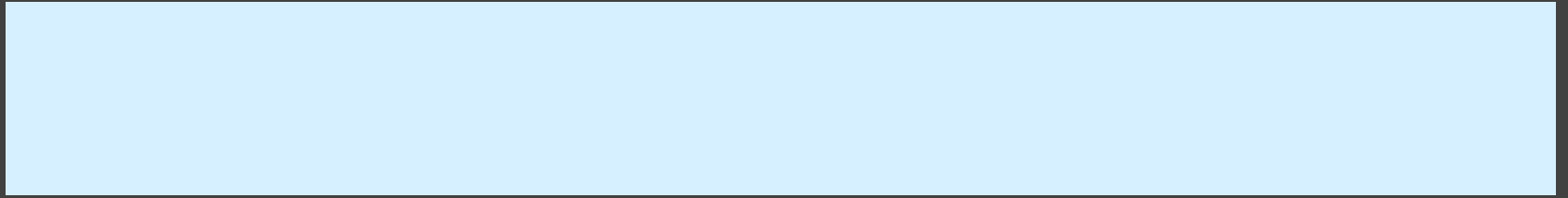

Compare length of bars

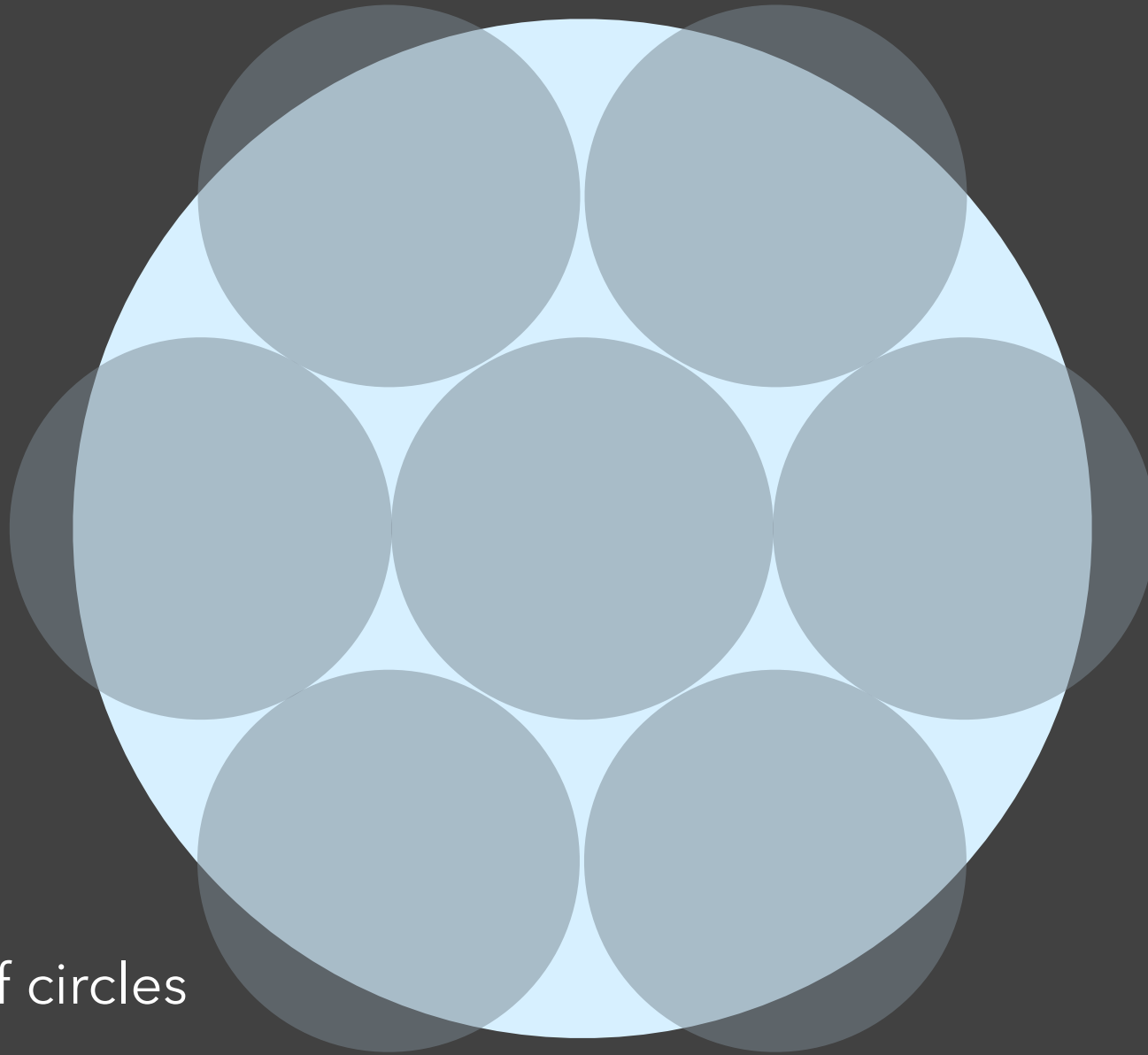
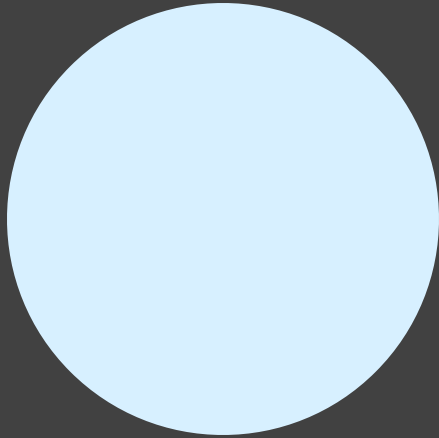

Compare area of circles

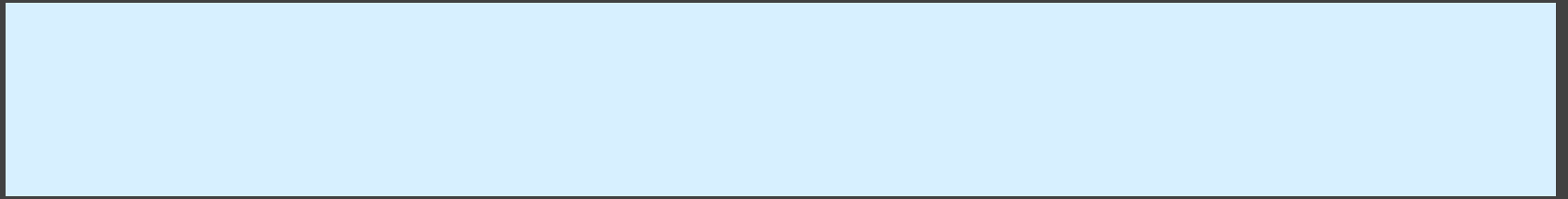

Compare length of bars

Steven's Power Law

Exponent
(Empirically Determined)

$$S = I^p$$

↑ ↑
Perceived Physical
Sensation Intensity

Predicts bias, not necessarily accuracy!

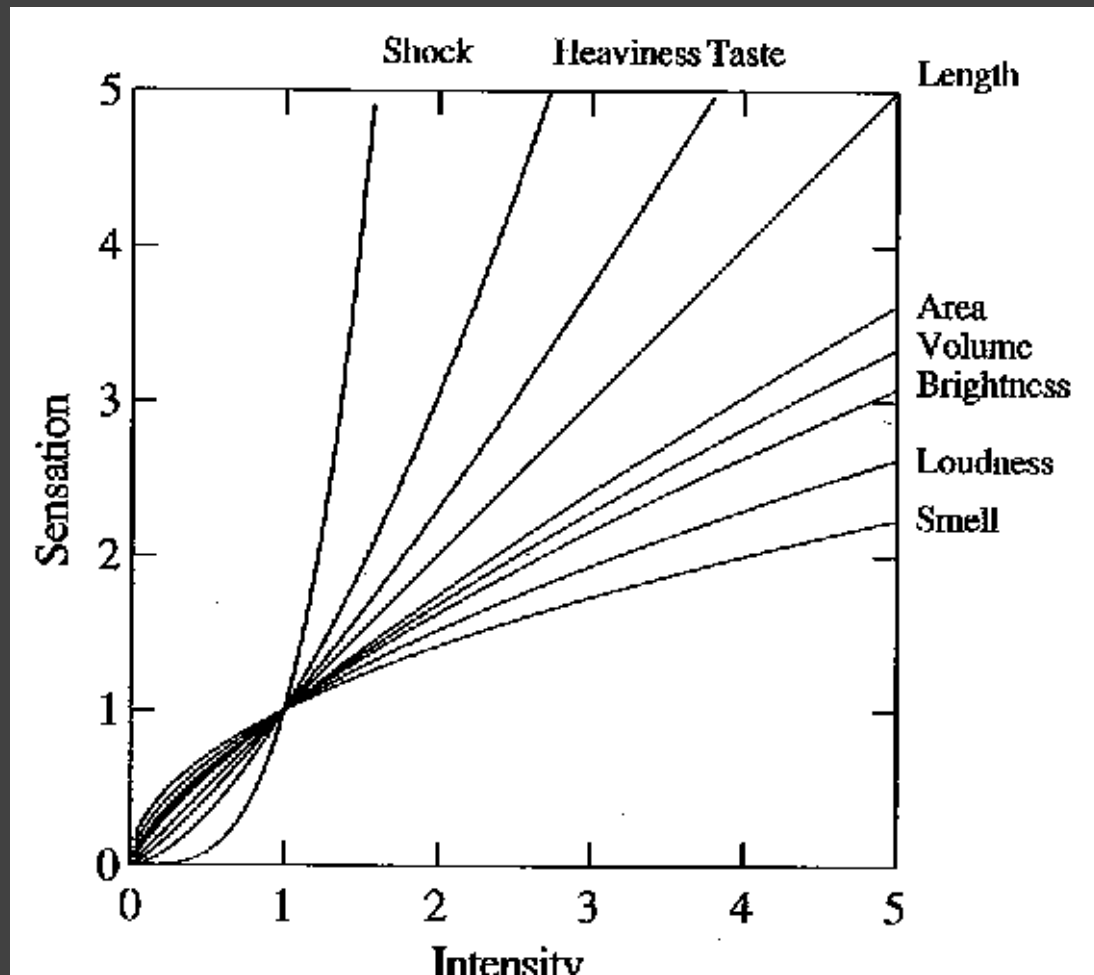

[Graph from Wilkinson '99, based on Stevens '61]

Exponents of Power Law

Sensation	Exponent
Loudness	0.6
Brightness	0.33
Smell	0.55 (Coffee) - 0.6 (Heptane)
Taste	0.6 (Saccharine) -1.3 (Salt)
Temperature	1.0 (Cold) – 1.6 (Warm)
Vibration	0.6 (250 Hz) – 0.95 (60 Hz)
Duration	1.1
Pressure	1.1
Heaviness	1.45
Electric Shock	3.5

[Psychophysics of Sensory Function, Stevens '61]

Apparent Magnitude Scaling

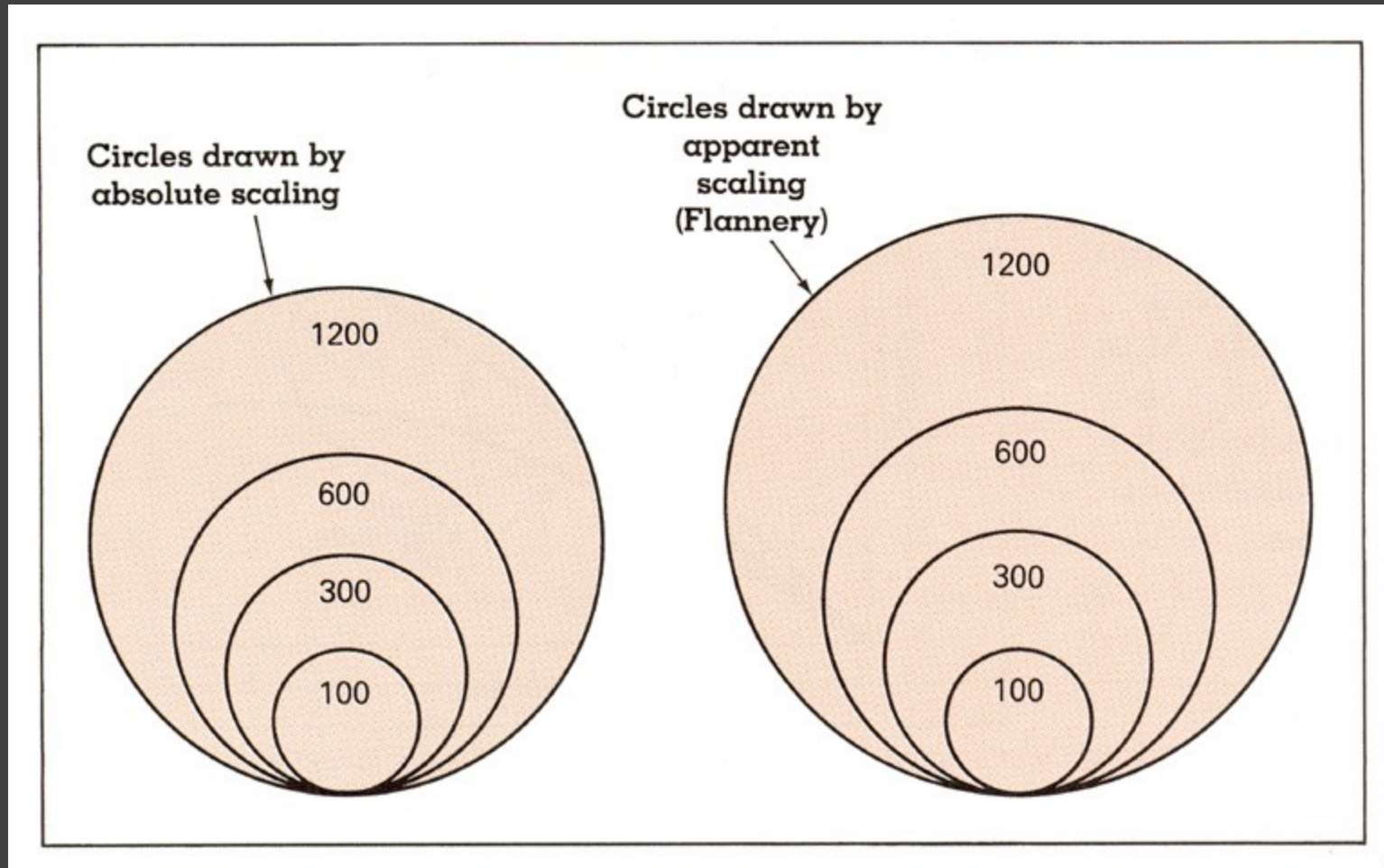

[Cartography: Thematic Map Design, Figure 8.6, p. 170, Dent, '96]

$$S = 0.98A^{0.87} \text{ [from Flannery '71]}$$

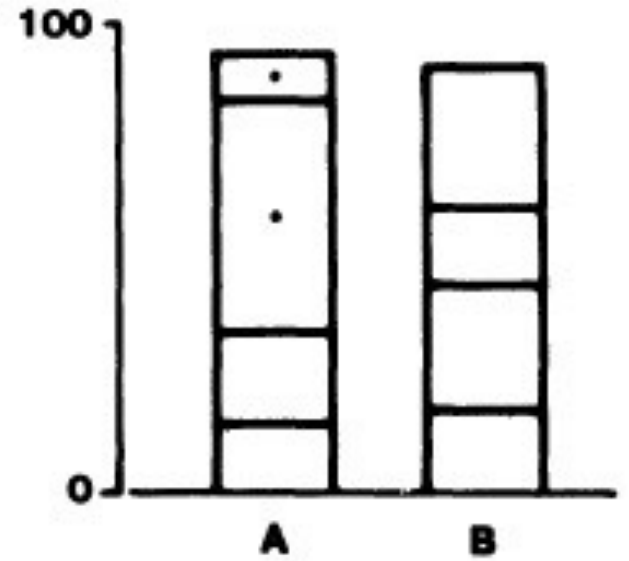
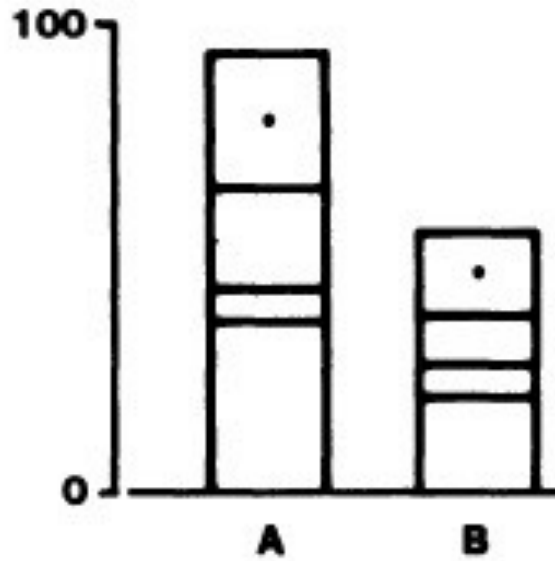
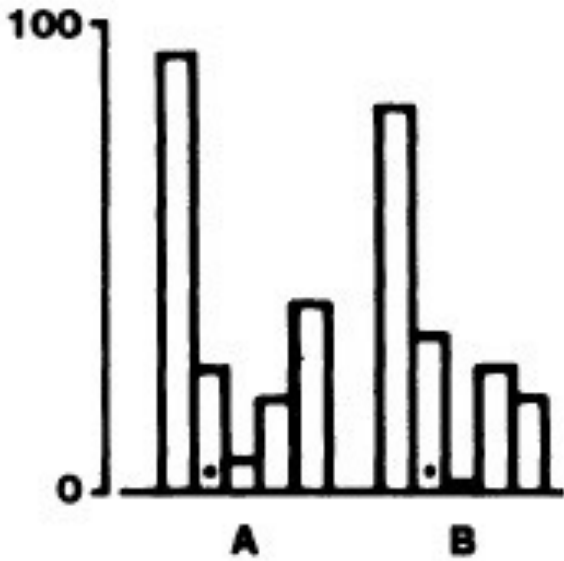

Graphical Perception [Cleveland & McGill 84]

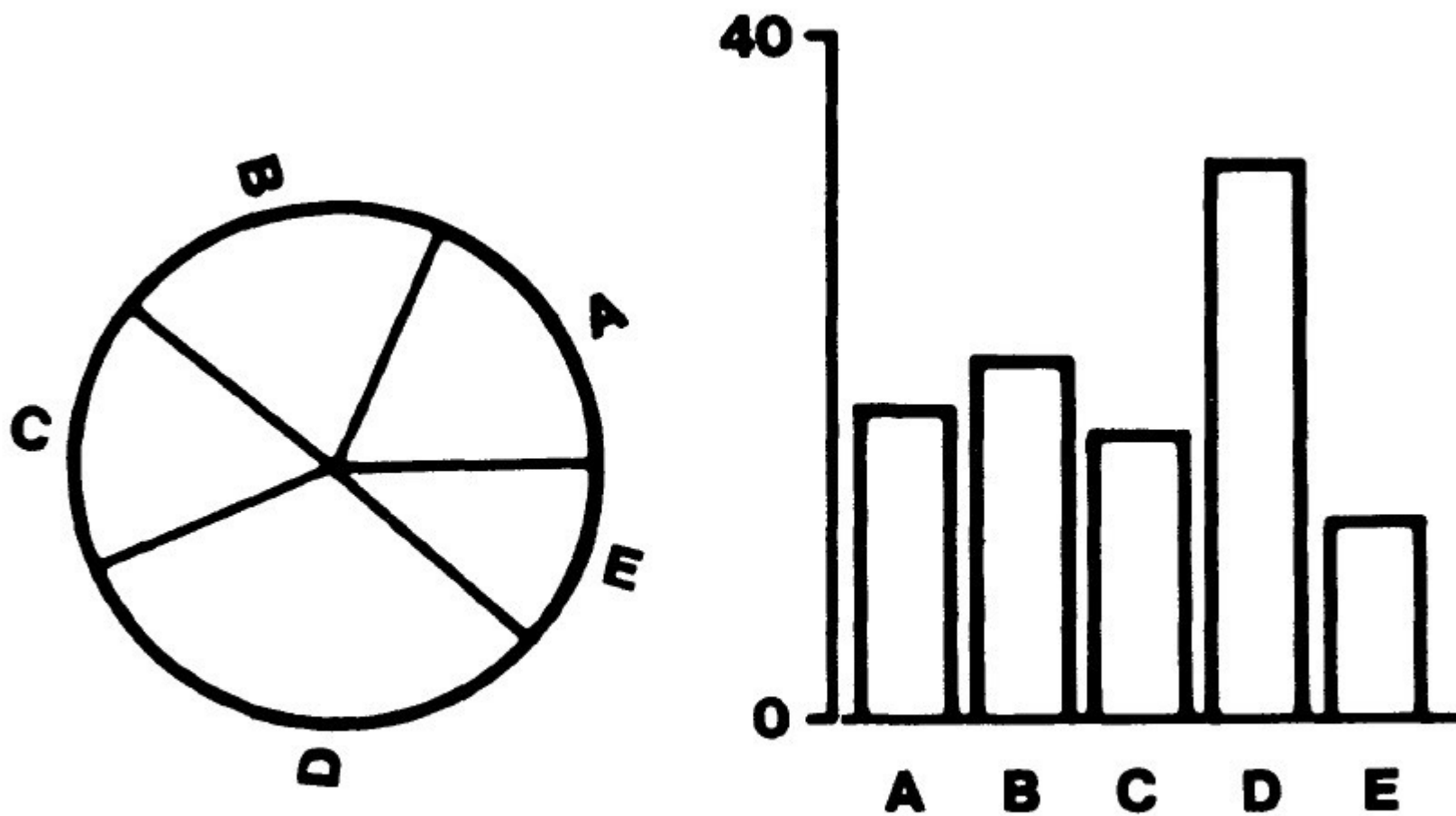
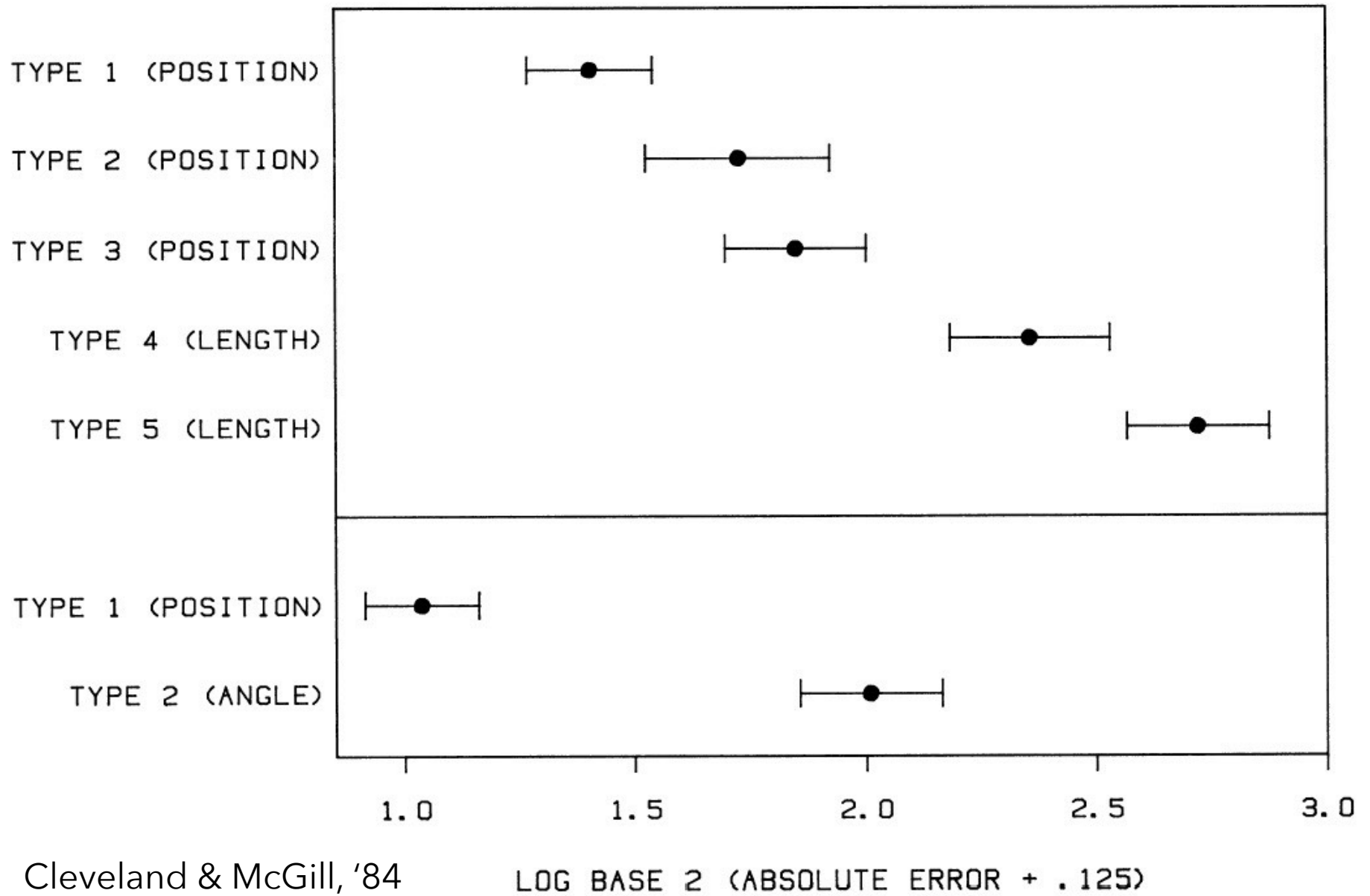

Figure 3. Graphs from position-angle experiment.



Cleveland & McGill, '84

LOG BASE 2 (ABSOLUTE ERROR + .125)

Figure 16. Log absolute error means and 95% confidence intervals for judgment types in position-length experiment (top) and position-angle experiment (bottom).

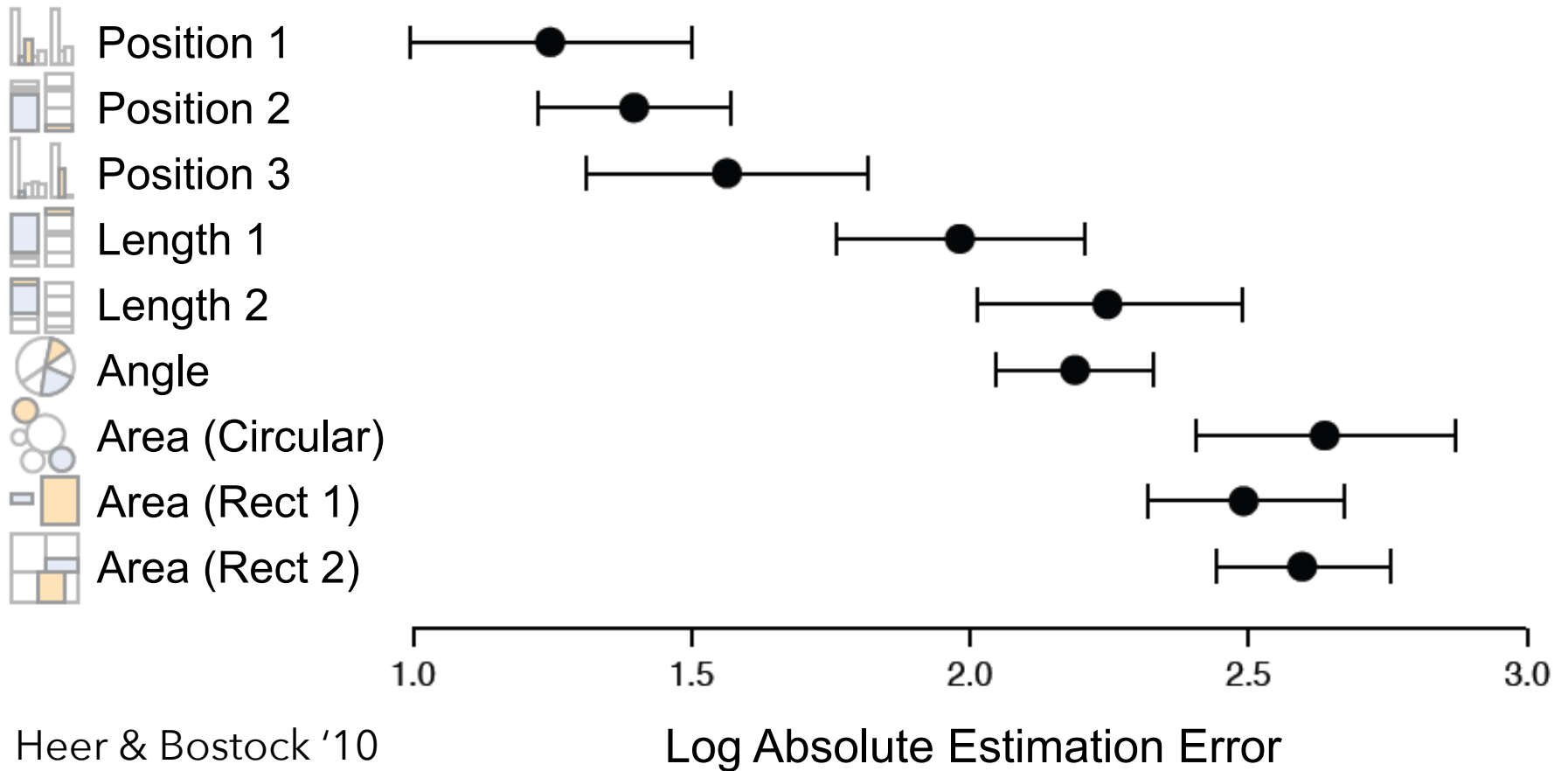

Graphical Perception Experiments

Empirical estimates of encoding effectiveness

Relative Magnitude Comparison

Most accurate



Least accurate



Position (common) scale



Position (non-aligned) scale



Length



Slope



Angle



Area



Volume



Color hue-saturation-density

Effectiveness Rankings [Mackinlay 86]

QUANTITATIVE

Position
Length
Angle
Slope
Area (Size)
Volume
Density (Value)
Color Sat
Color Hue
Texture
Connection
Containment
Shape

ORDINAL

Position
Density (Value)
Color Sat
Color Hue
Texture
Connection
Containment
Length
Angle
Slope
Area (Size)
Volume
Shape

NOMINAL

Position
Color Hue
Texture
Connection
Containment
Density (Value)
Color Sat
Shape
Length
Angle
Slope
Area
Volume

Multiple Attributes

One-Dimensional: Lightness



White



White



Black



White



Black



White



Black



Black



White



White

One-Dimensional: Shape



Square



Circle



Circle



Square



Circle



Circle



Circle



Square



Circle



Circle

Redundant: Shape & Lightness



Circle



Square



Square



Circle



Square



Circle



Square



Square



Square



Circle

Orthogonal: Shape & Lightness



Circle



Square



Square



Circle



Square

Speeded Classification

Redundancy Gain

Facilitation in reading one dimension when the other provides redundant information

Filtering Interference

Difficulty in ignoring one dimension while attending to the other

Speeded Classification

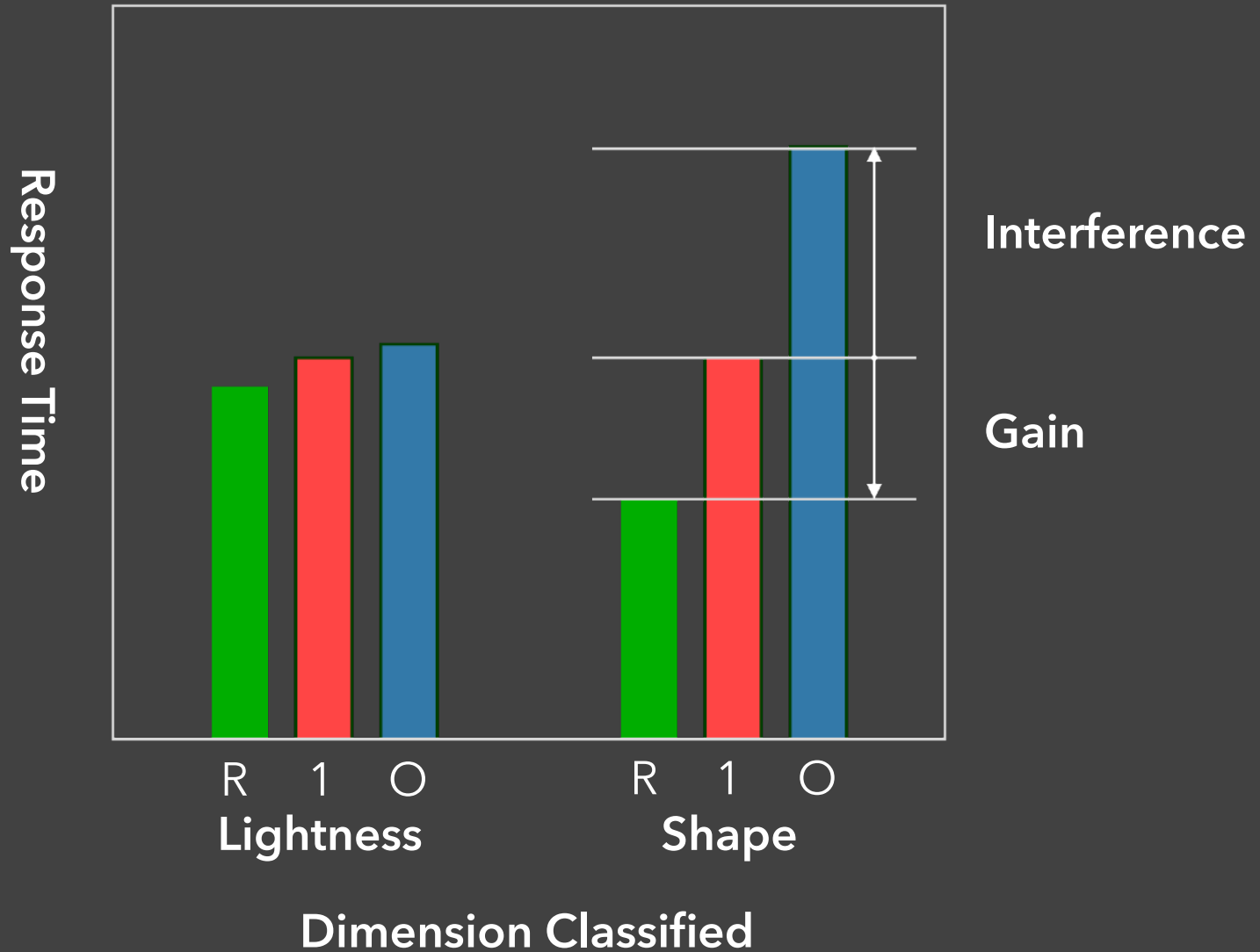

Types of Perceptual Dimensions

Integral

Filtering interference and redundancy gain

Separable

No interference or gain

Asymmetric

One dim separable from other, not vice versa

Size and Brightness

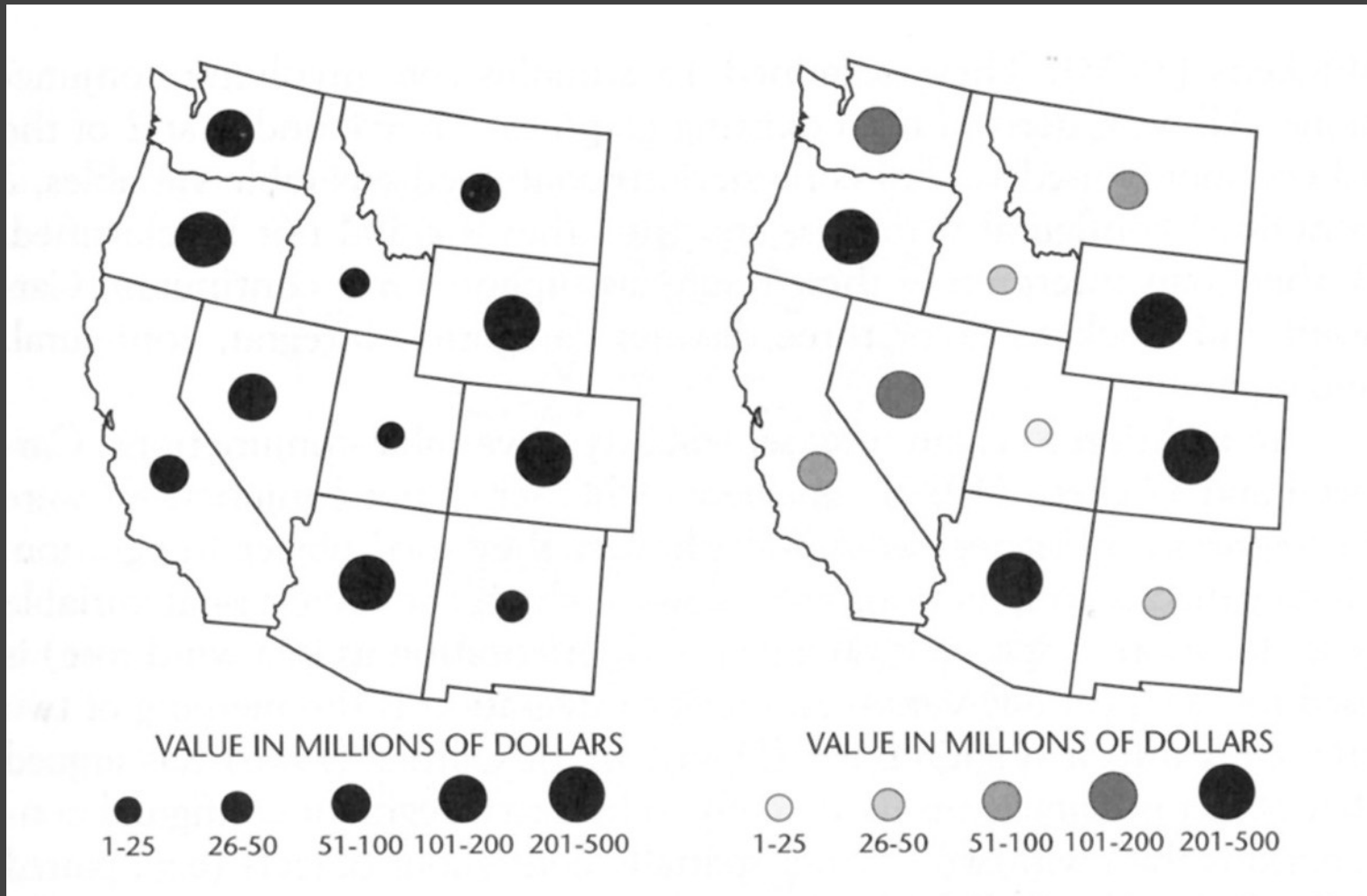

W. S. Dobson, Visual information processing and cartographic communication: The role of redundant stimulus dimensions, 1983 (reprinted in MacEachren, 1995)

Orientation & Size

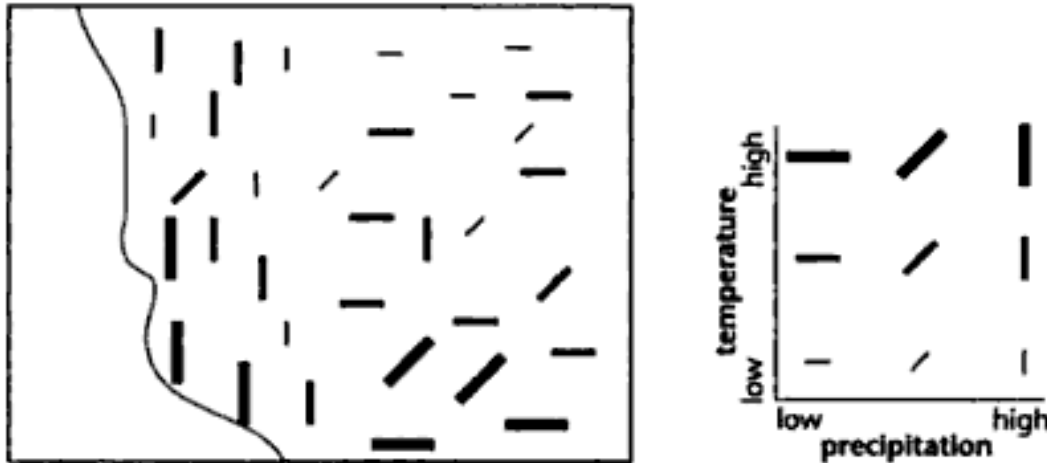

FIGURE 3.36. A map of temperature and precipitation using symbol size and orientation to represent data values on the two variables.

How well can you see temperature or precipitation?
Is there a correlation between the two?

Length & Length

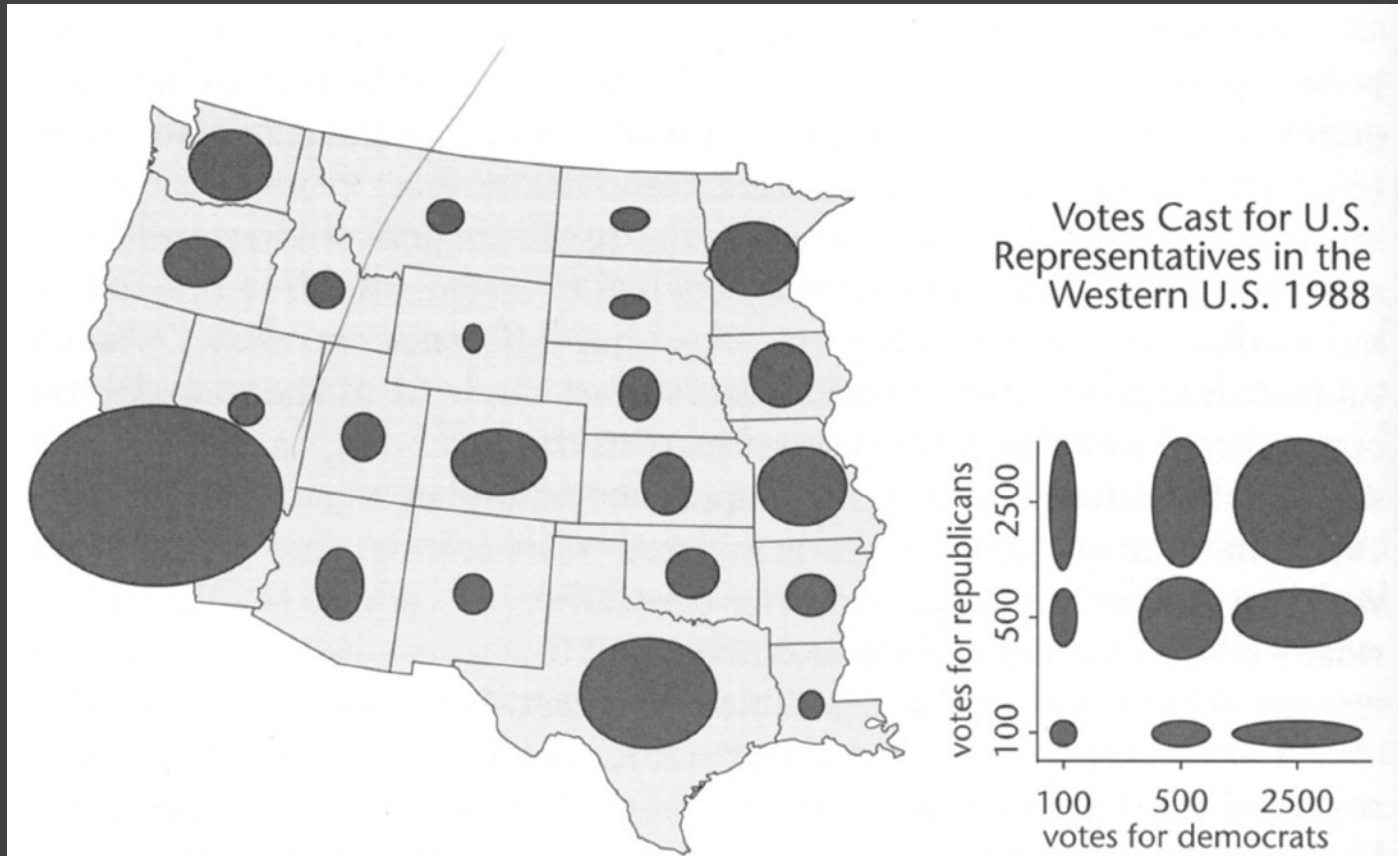

FIGURE 3.38. An example of the use of an ellipse as a map symbol in which the horizontal and vertical axes represent different (but presumably related) variables.

Angle & Angle

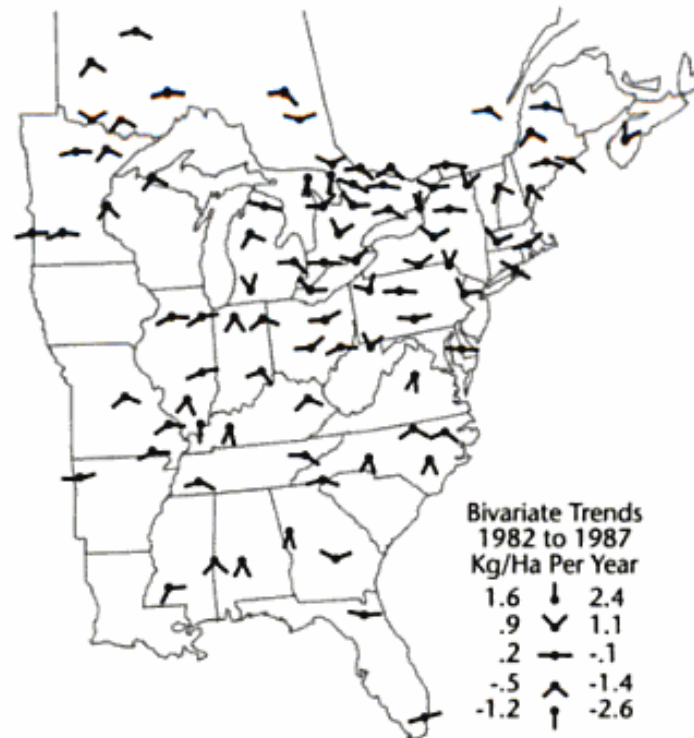
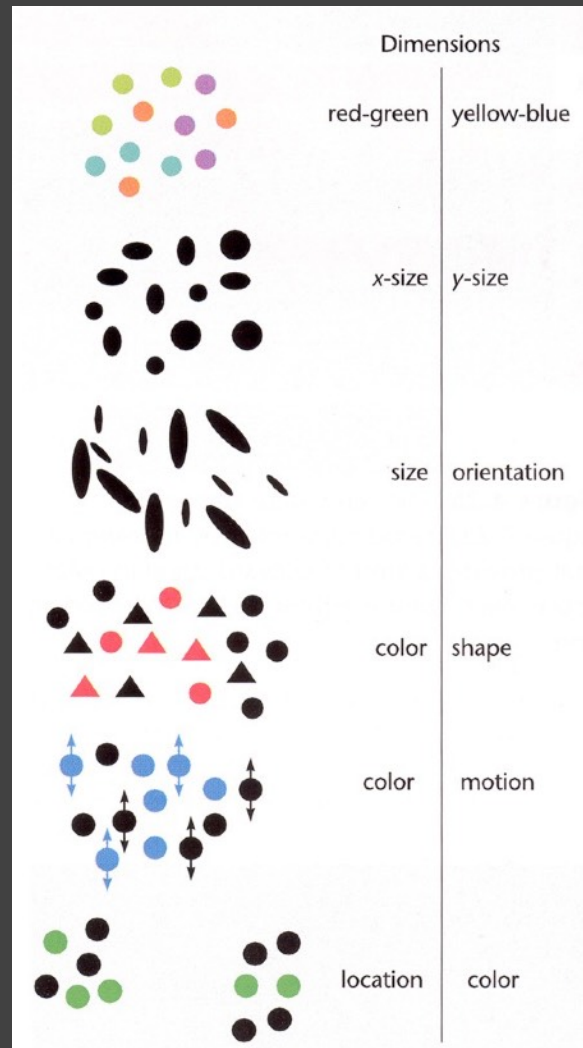

FIGURE 3.39. Bivariate map of NO_3 and SO_4 trends. The original Carr et al. version of this map used a wheel with eight spokes, rather than a simple dot, as the center of each glyph. When large enough, this added feature facilitates judgment of specific values. After Carr et al. (1992, Fig. 7a, p. 234). Adapted by permission of the American Congress on Surveying and Mapping.

Summary of Integral & Separable



Integral

Separable

[Figure 5.25,
Color Plate 10,
Ware 2000]

Set

Each card has **4 features**:

Color

Symbol

Number

Shading/Texture

A set consists of 3 cards in which each feature is the **SAME** or **DIFFERENT** on each card.

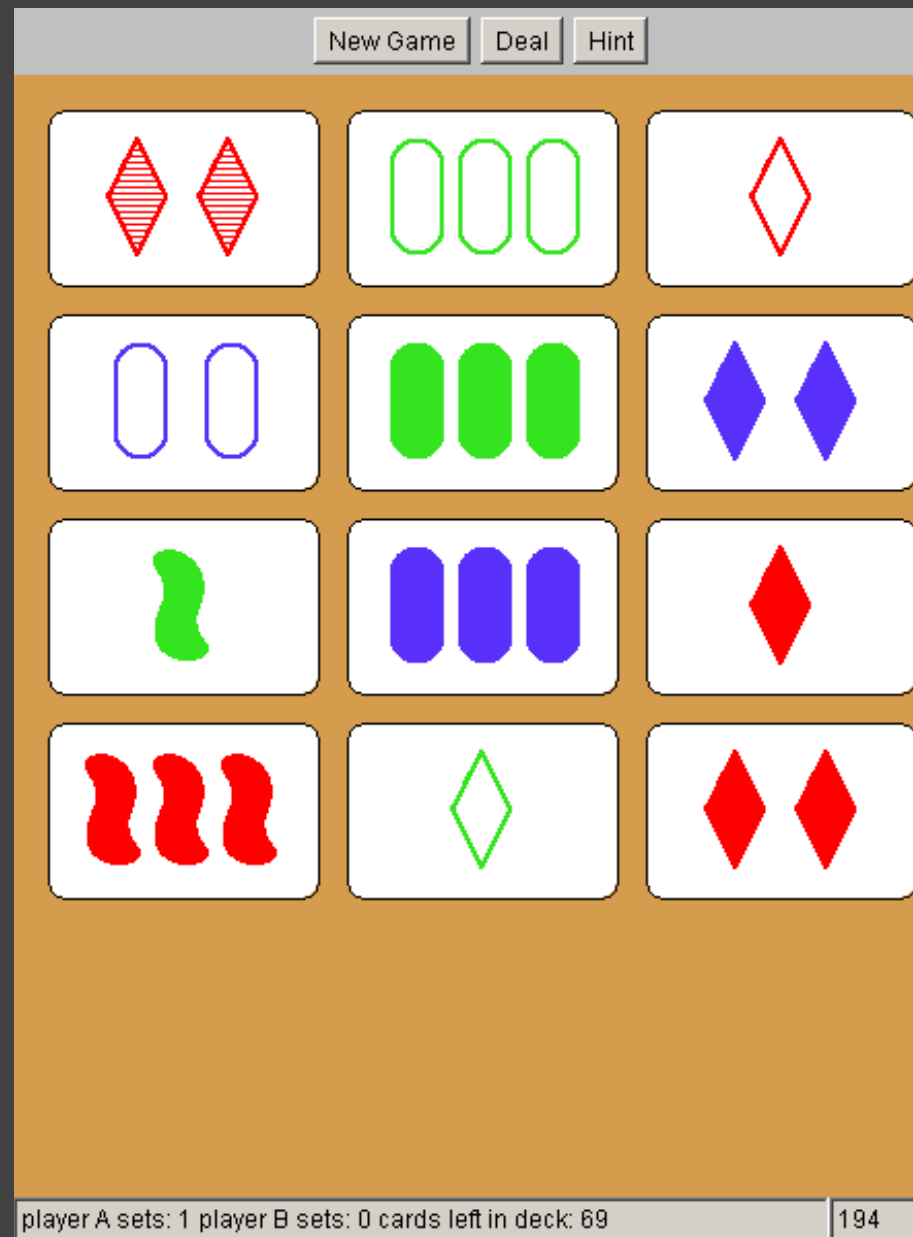

Pre-Attentive Processing

How Many 3's?

1281768756138976546984506985604982826762
9809858458224509856458945098450980943585
9091030209905959595772564675050678904567
8845789809821677654876364908560912949686

[based on a slide from J. Stasko]

How Many 3's?

1281768756138976546984506985604982826762
9809858458224509856458945098450980943585
9091030209905959595772564675050678904567
8845789809821677654876364908560912949686

[based on a slide from J. Stasko]

Visual Pop-Out: Color

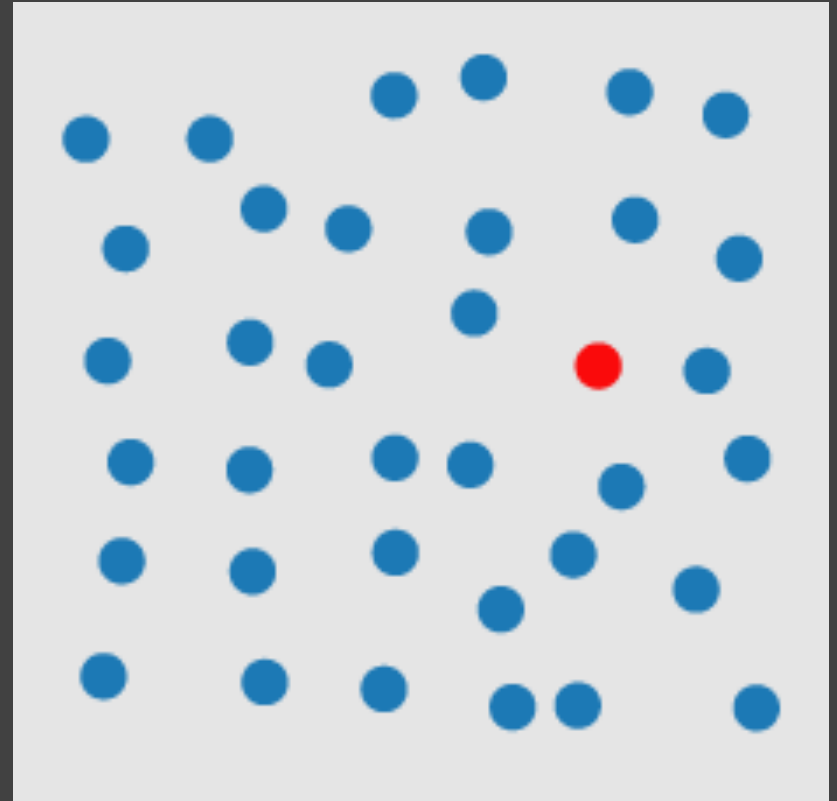
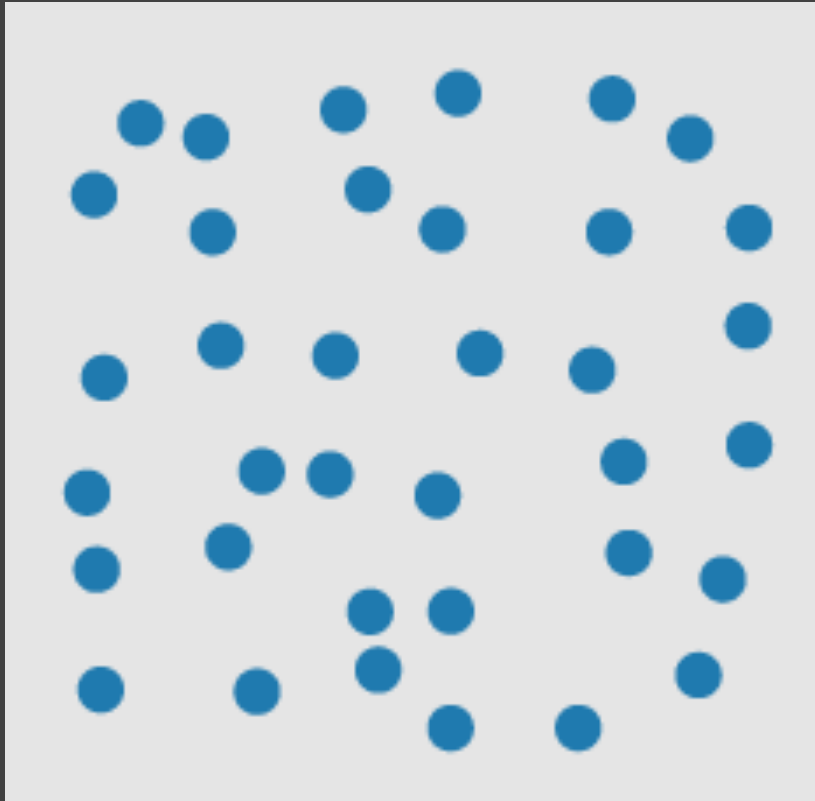

<http://www.csc.ncsu.edu/faculty/healey/PP/index.html>

Visual Pop-Out: Shape

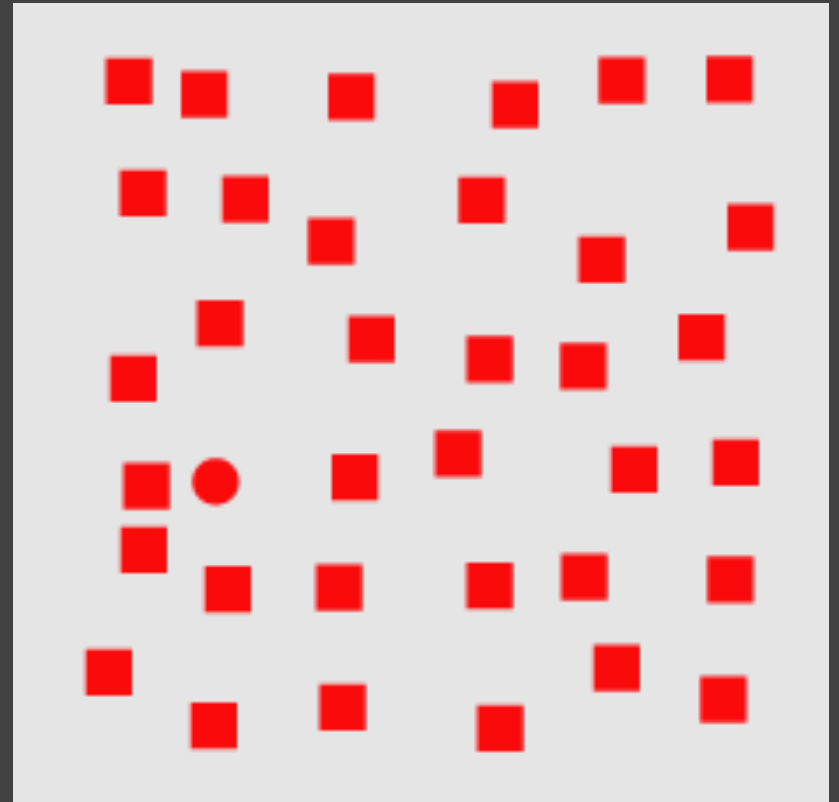
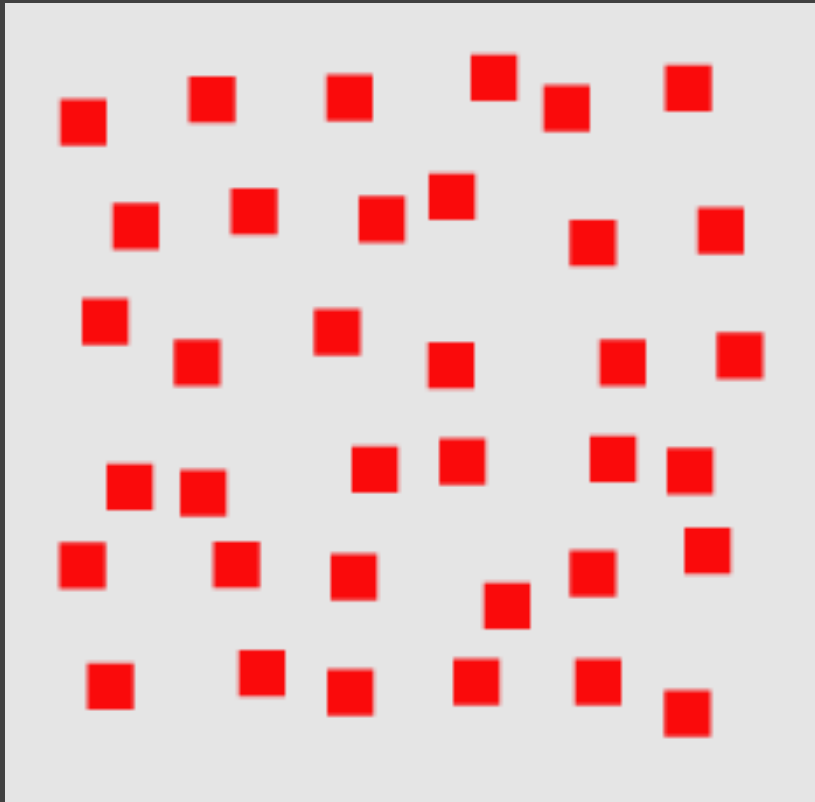

<http://www.csc.ncsu.edu/faculty/healey/PP/index.html>

Feature Conjunctions

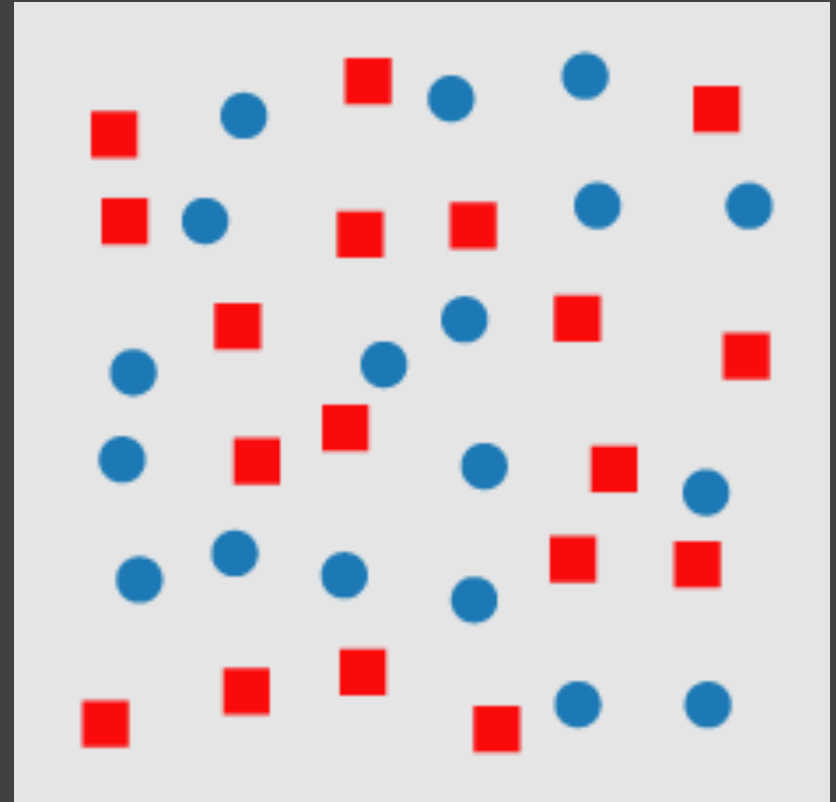
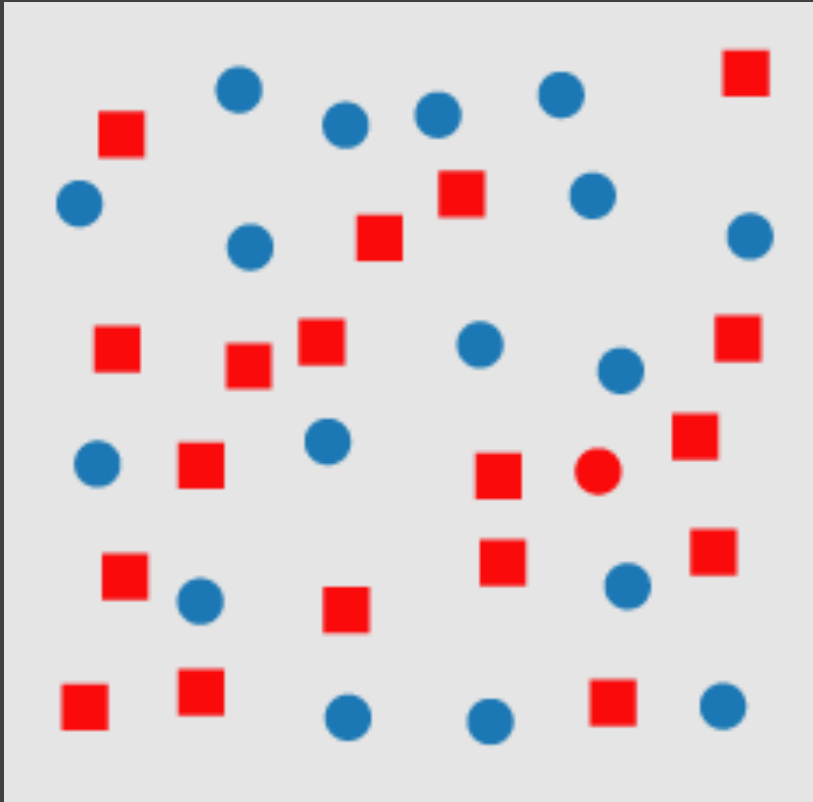

Pre-Attentive Features

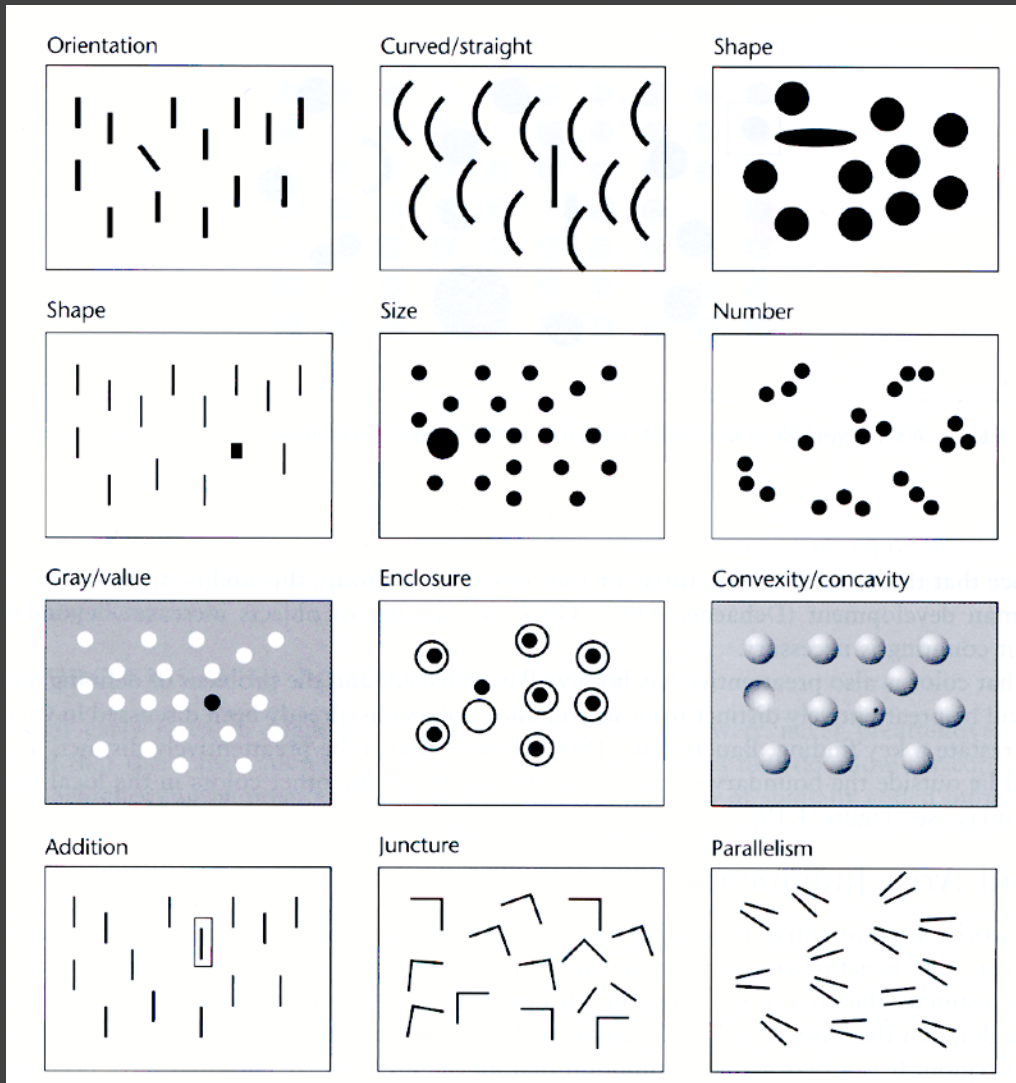

[Information Visualization.
Figure 5.5 Ware 04]

More Pre-Attentive Features

Line (blob) orientation	Julesz & Bergen [1983]; Wolfe et al. [1992]
Length	Treisman & Gormican [1988]
Width	Julesz [1985]
Size	Treisman & Gelade [1980]
Curvature	Treisman & Gormican [1988]
Number	Julesz [1985]; Trick & Pylyshyn [1994]
Terminators	Julesz & Bergen [1983]
Intersection	Julesz & Bergen [1983]
Closure	Enns [1986]; Treisman & Souther [1985]
Colour (hue)	Nagy & Sanchez [1990, 1992]; D'Zmura [1991]; Kawai et al. [1995]; Bauer et al. [1996]
Intensity	Beck et al. [1983]; Treisman & Gormican [1988]
Flicker	Julesz [1971]
Direction of motion	Nakayama & Silverman [1986]; Driver & McLeod [1992]
Binocular lustre	Wolfe & Franzel [1988]
Stereoscopic depth	Nakayama & Silverman [1986]
3-D depth cues	Enns [1990]
Lighting direction	Enns [1990]

Pre-Attentive Conjunctions

Spatial conjunctions are often pre-attentive

Motion and 3D disparity

Motion and color

Motion and shape

3D disparity and color

3D disparity and shape

But most conjunctions are NOT pre-attentive

Feature Integration Theory

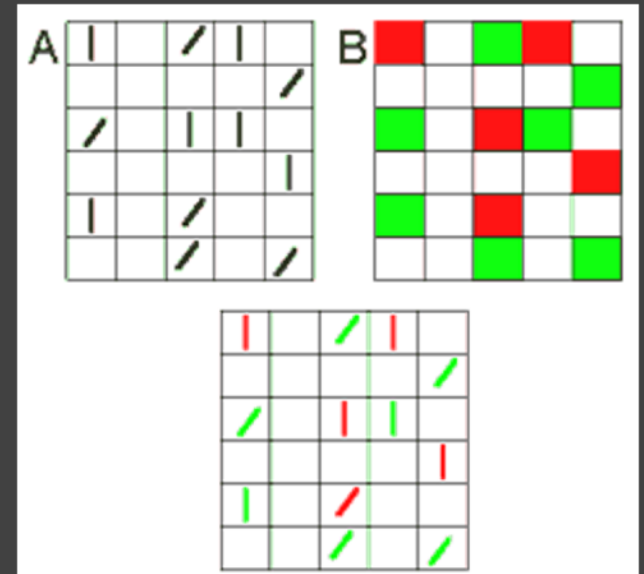
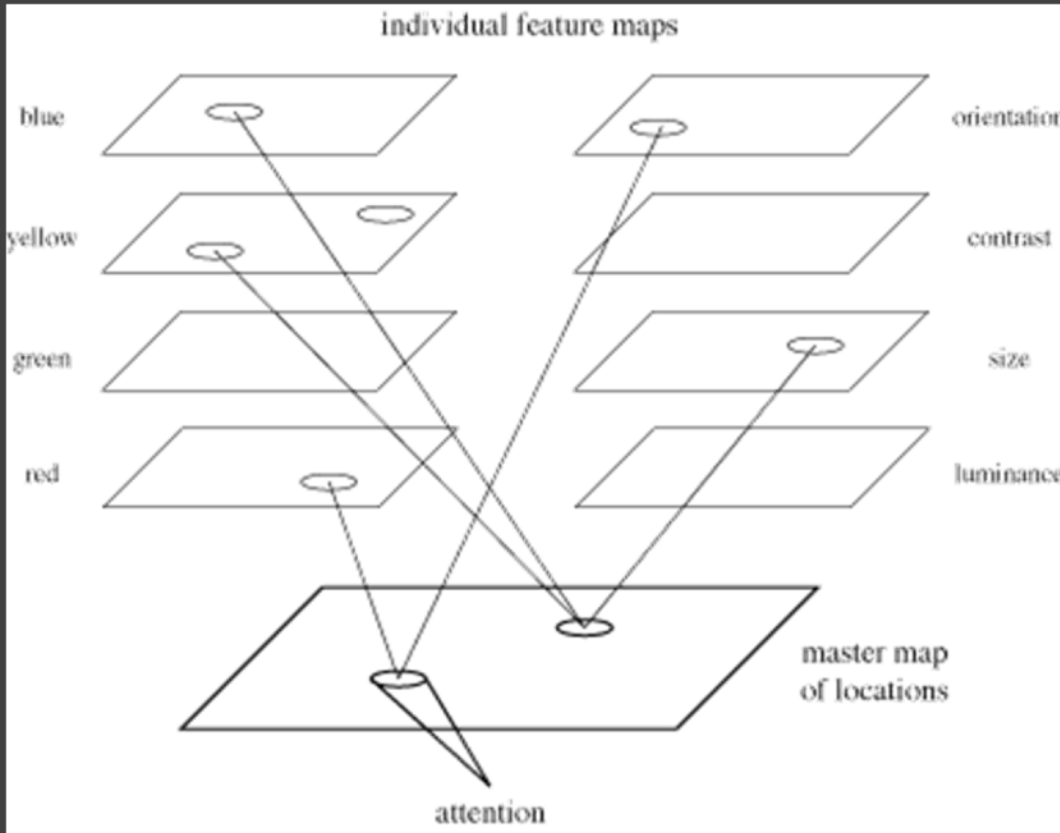

Feature maps for orientation & color [Green]

Treisman's feature integration model [Healey 04]

Gestalt Grouping

Gestalt Principles

Figure/Ground

Proximity

Similarity

Symmetry

Connectedness

Continuity

Closure

Common Fate

Transparency

Figure/Ground



Ambiguous

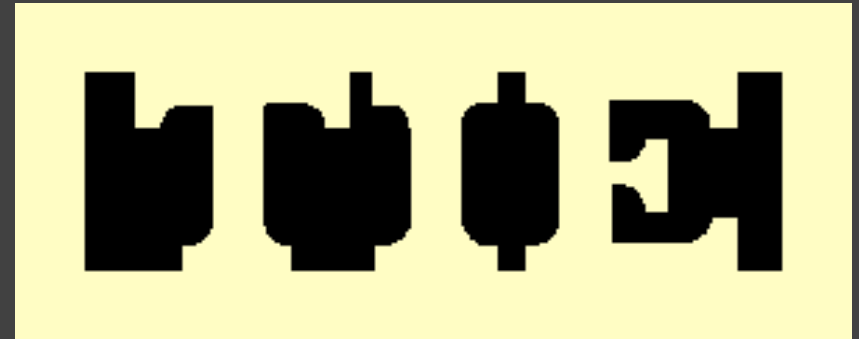

Principle of surroundedness

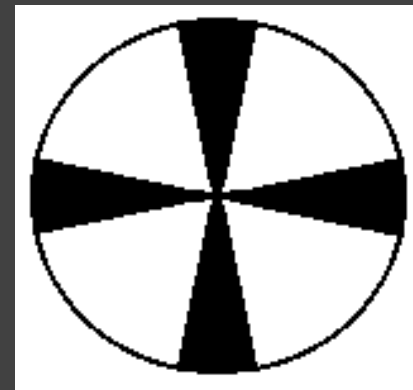

Principle of relative size

Figure/Ground



Ambiguous



Unambiguous (?)

Proximity

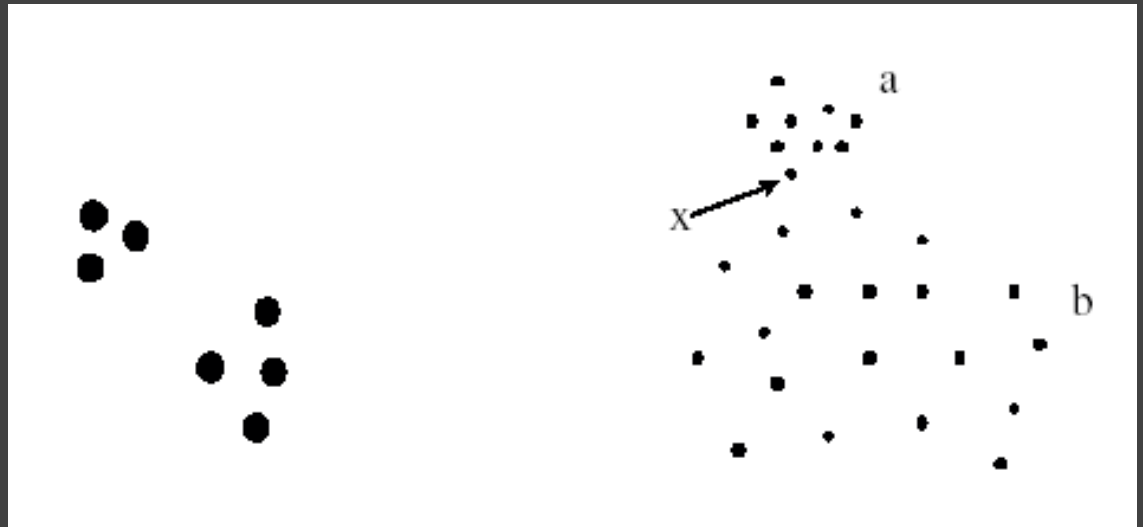
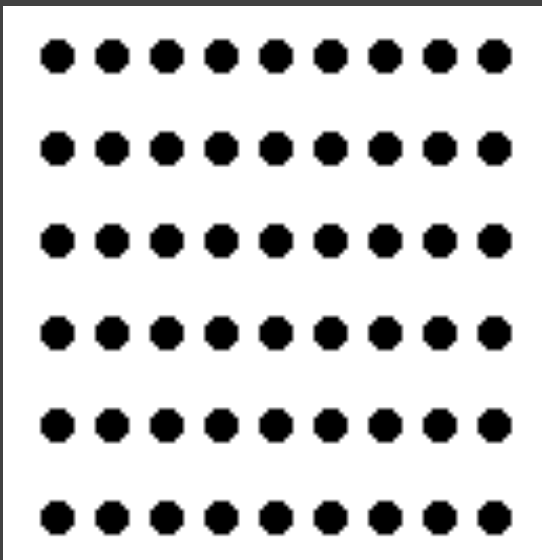
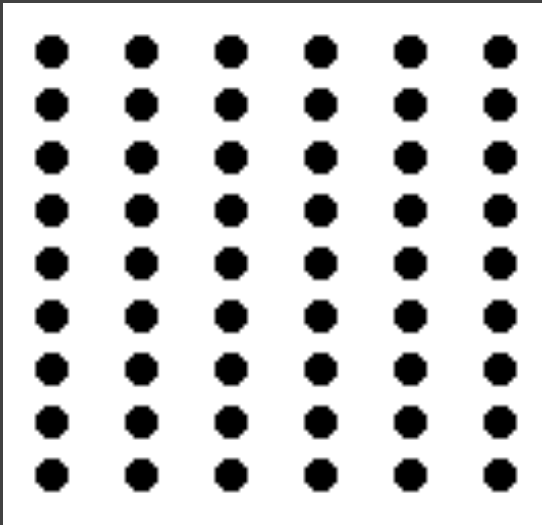

[Ware '00]

Similarity

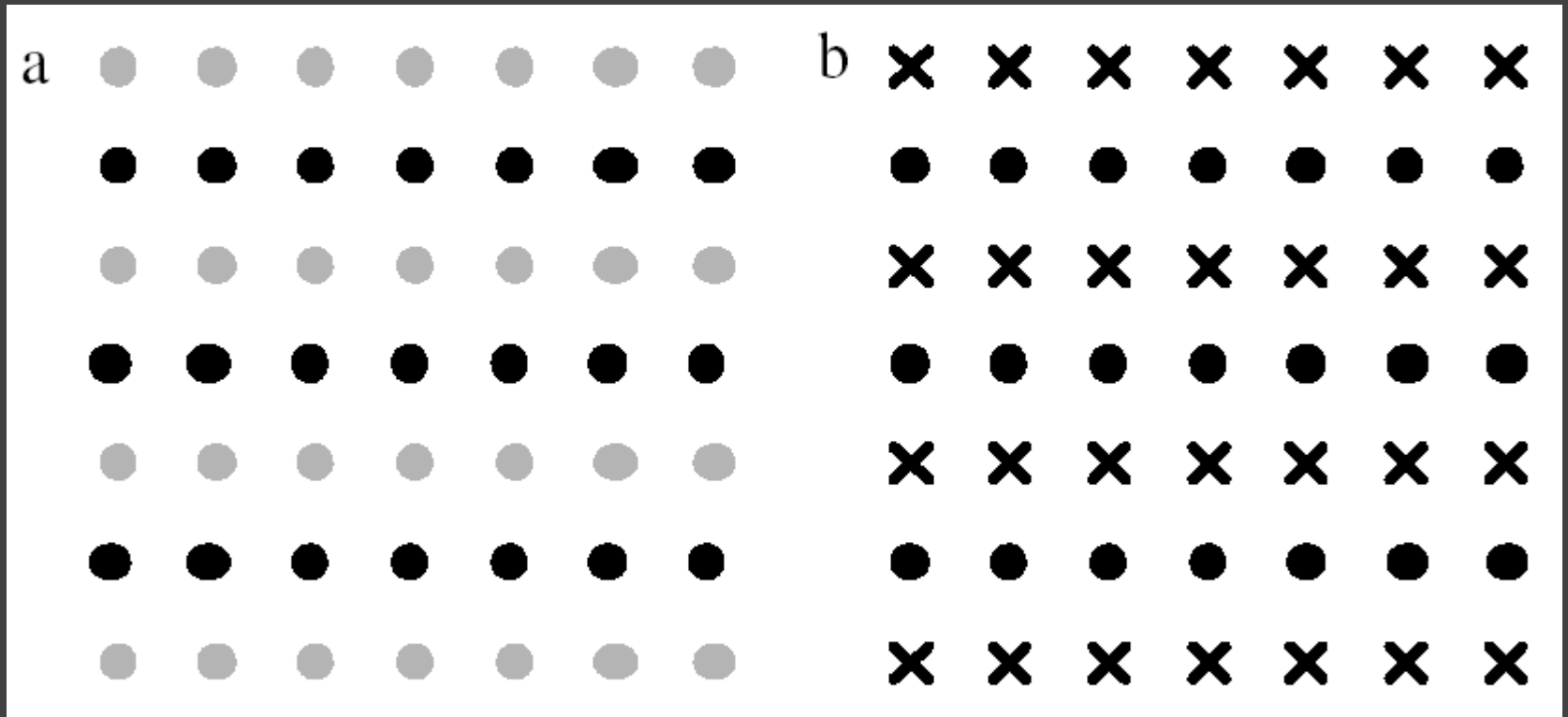

Rows dominate due to similarity [from Ware '04]

Symmetry

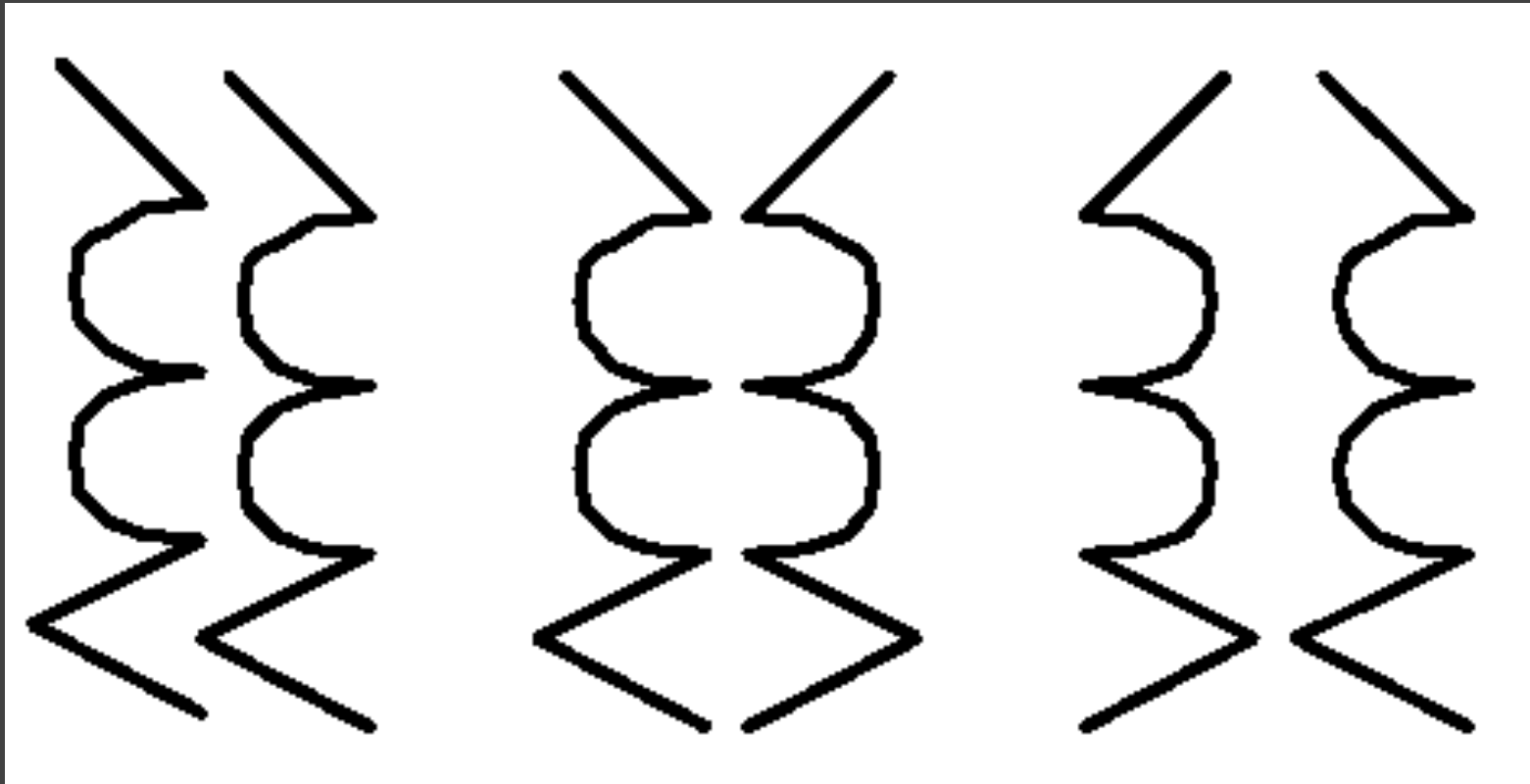

Bilateral symmetry gives strong sense of figure [from Ware '04]

Connectedness

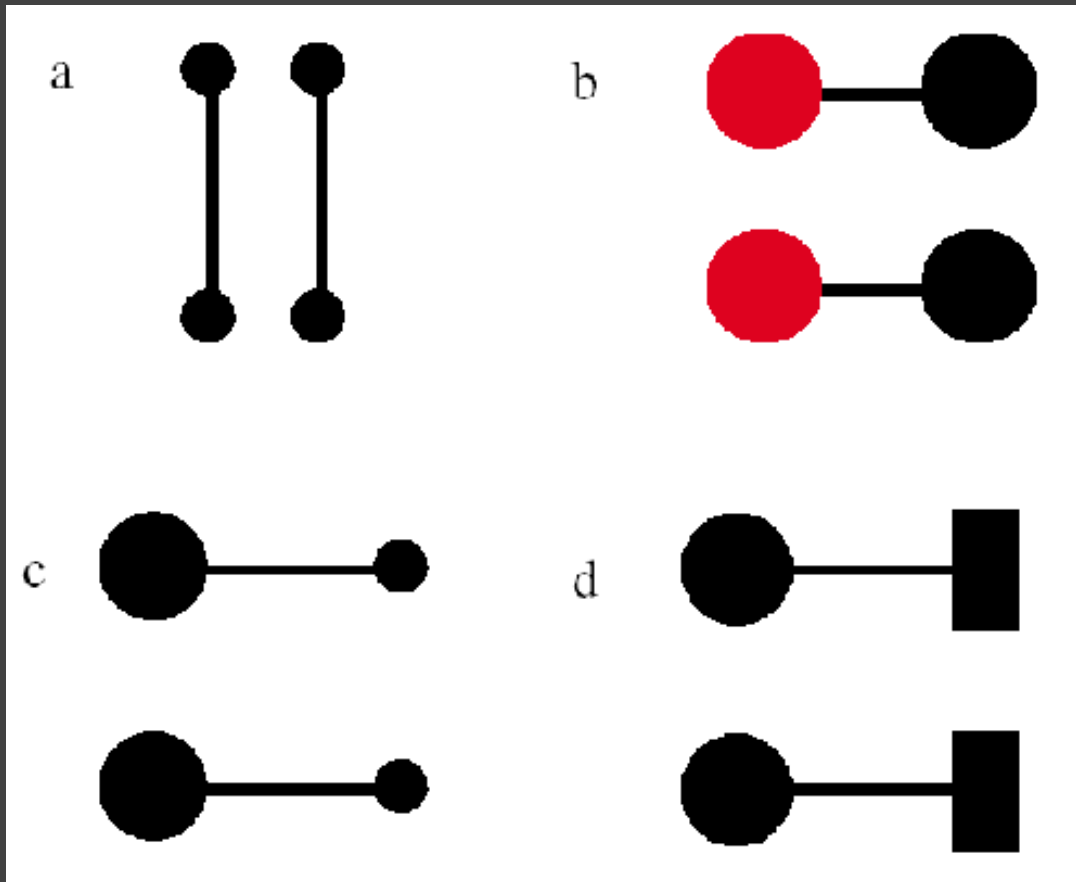

Connectedness overrules proximity, size, color shape [from Ware '04]

Continuity

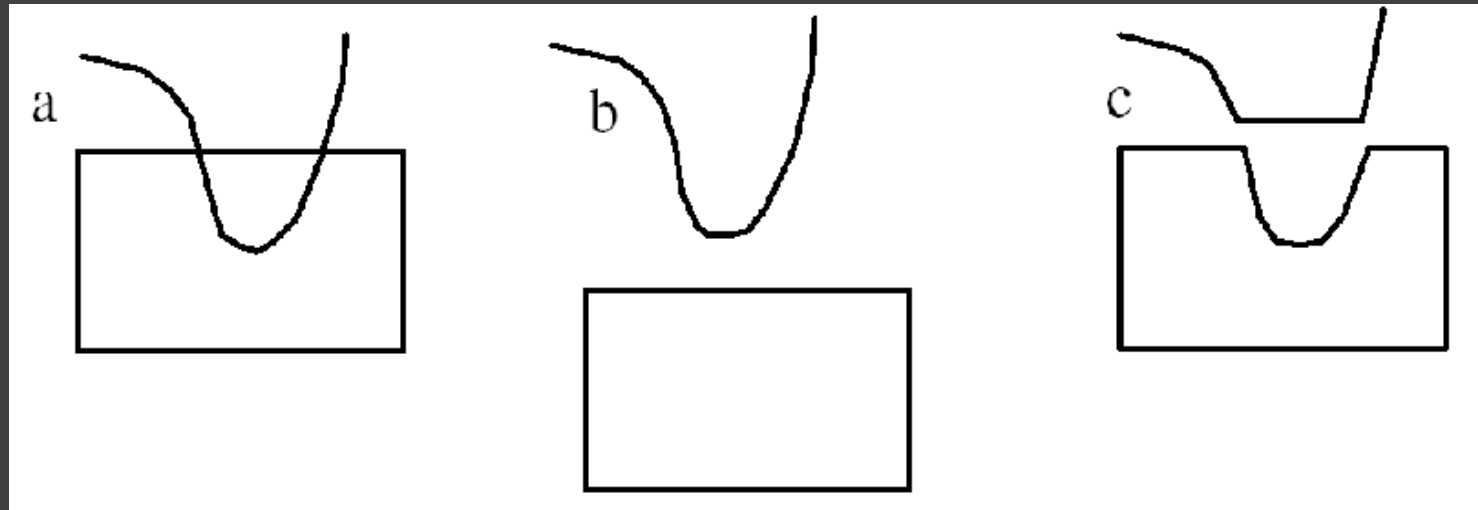

We prefer smooth not abrupt changes [from Ware '04]

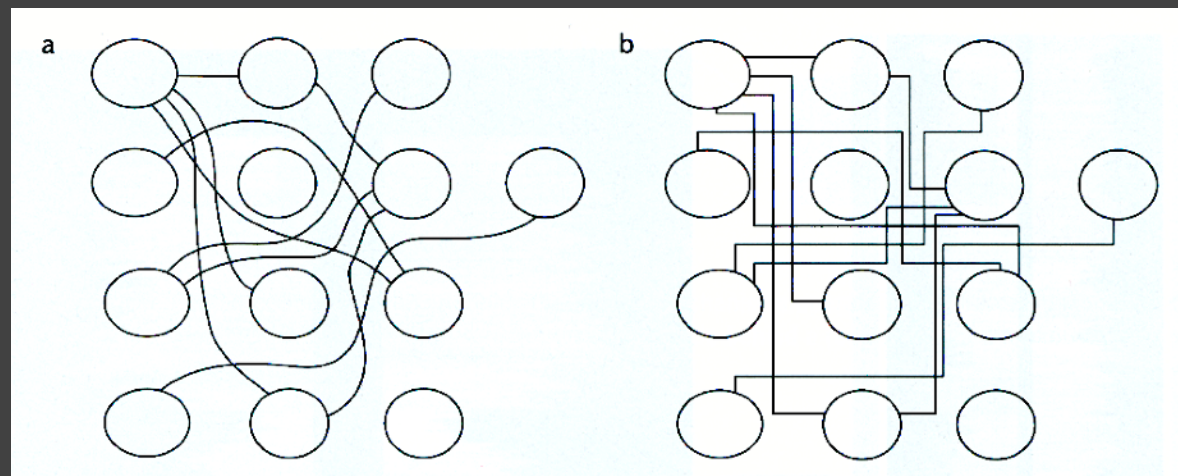

Connections are clearer with smooth contours [from Ware '04]

Continuity: Vector Fields

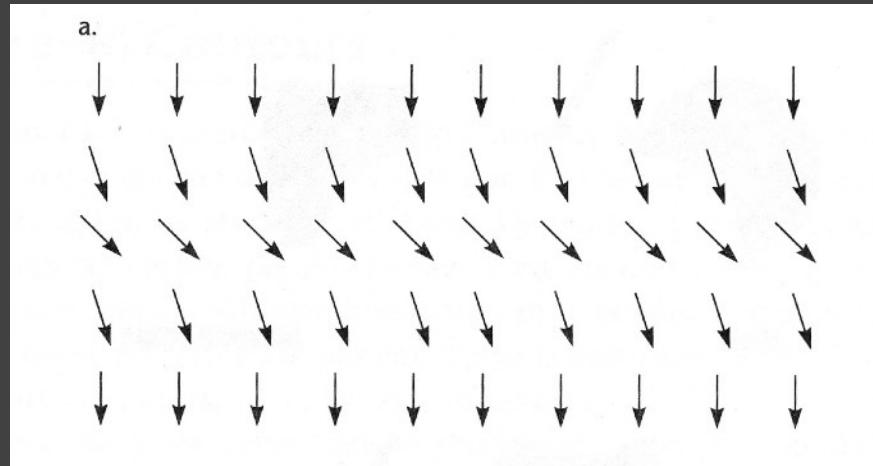

Continuity: Vector Fields

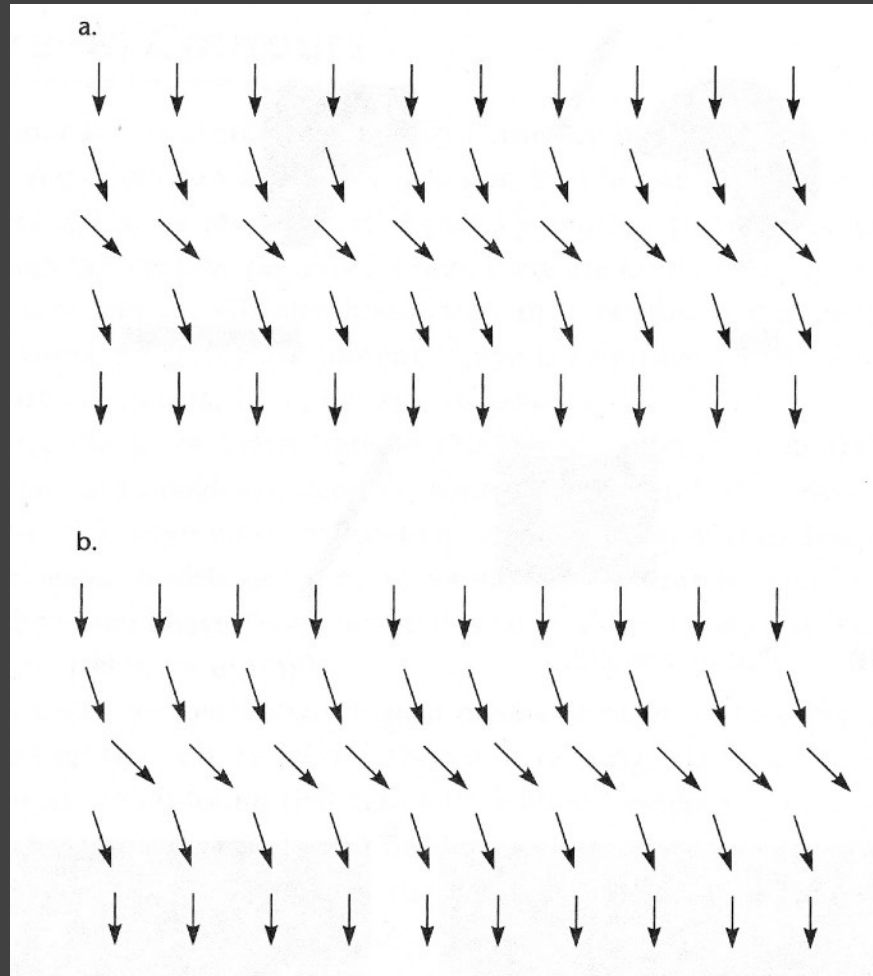

Prefer field that shows smooth continuous contours [from Ware '04]

Closure

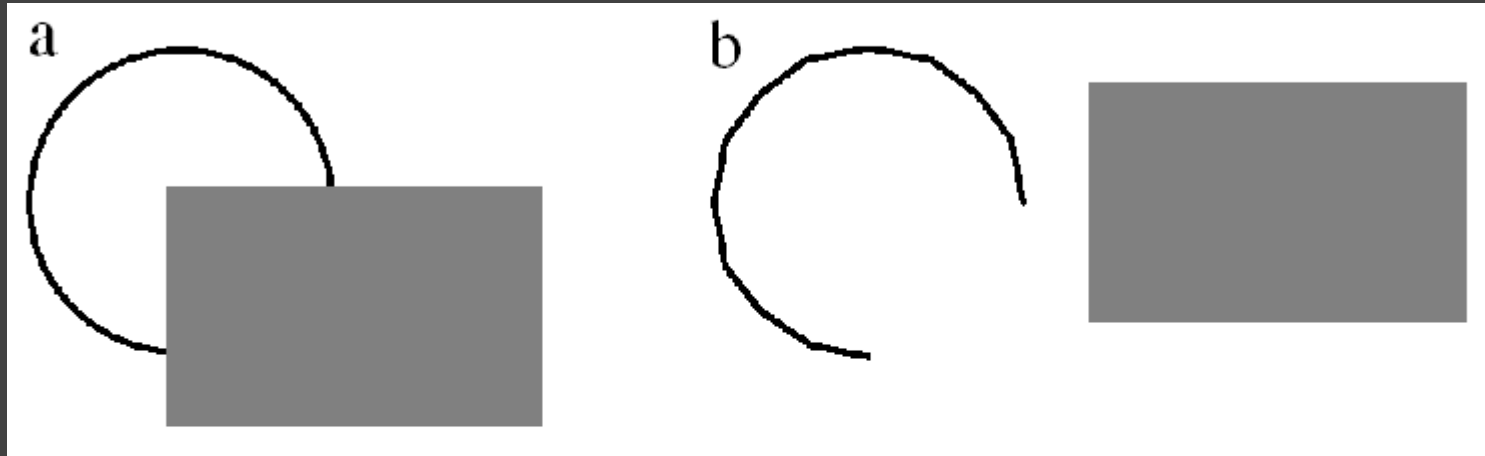

We see a circle behind a rectangle, not a broken circle [from Ware '04]

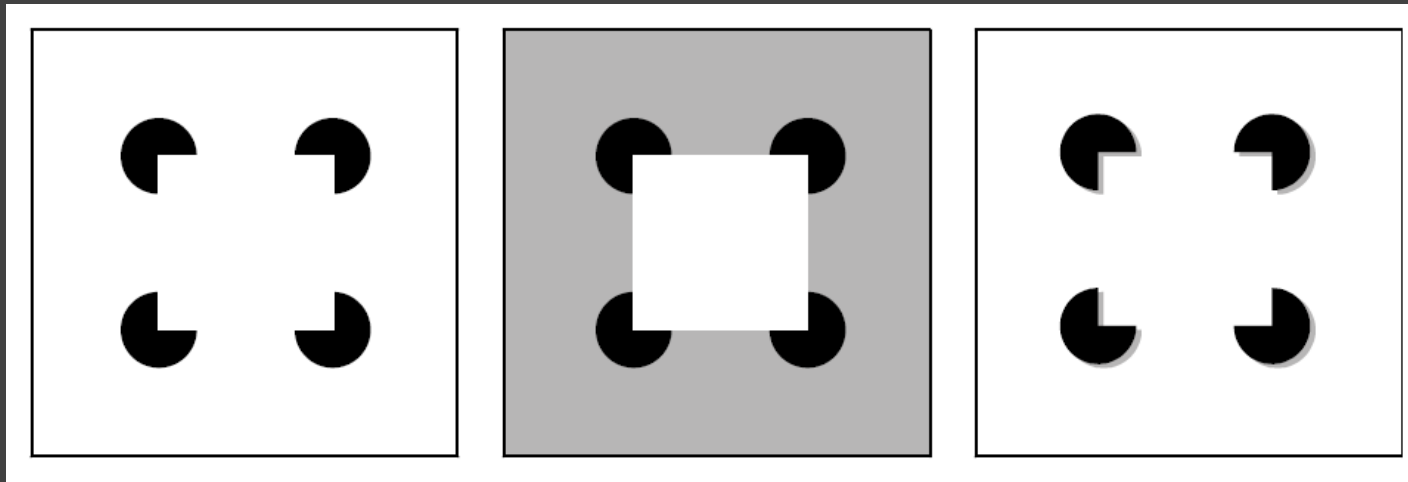

Illusory contours [from Durand '02]

Common Fate



Dots moving together are grouped

Transparency



Requires continuity and proper color correspondence [from Ware '04]

Change Blindness

Change Blindness



Change Blindness

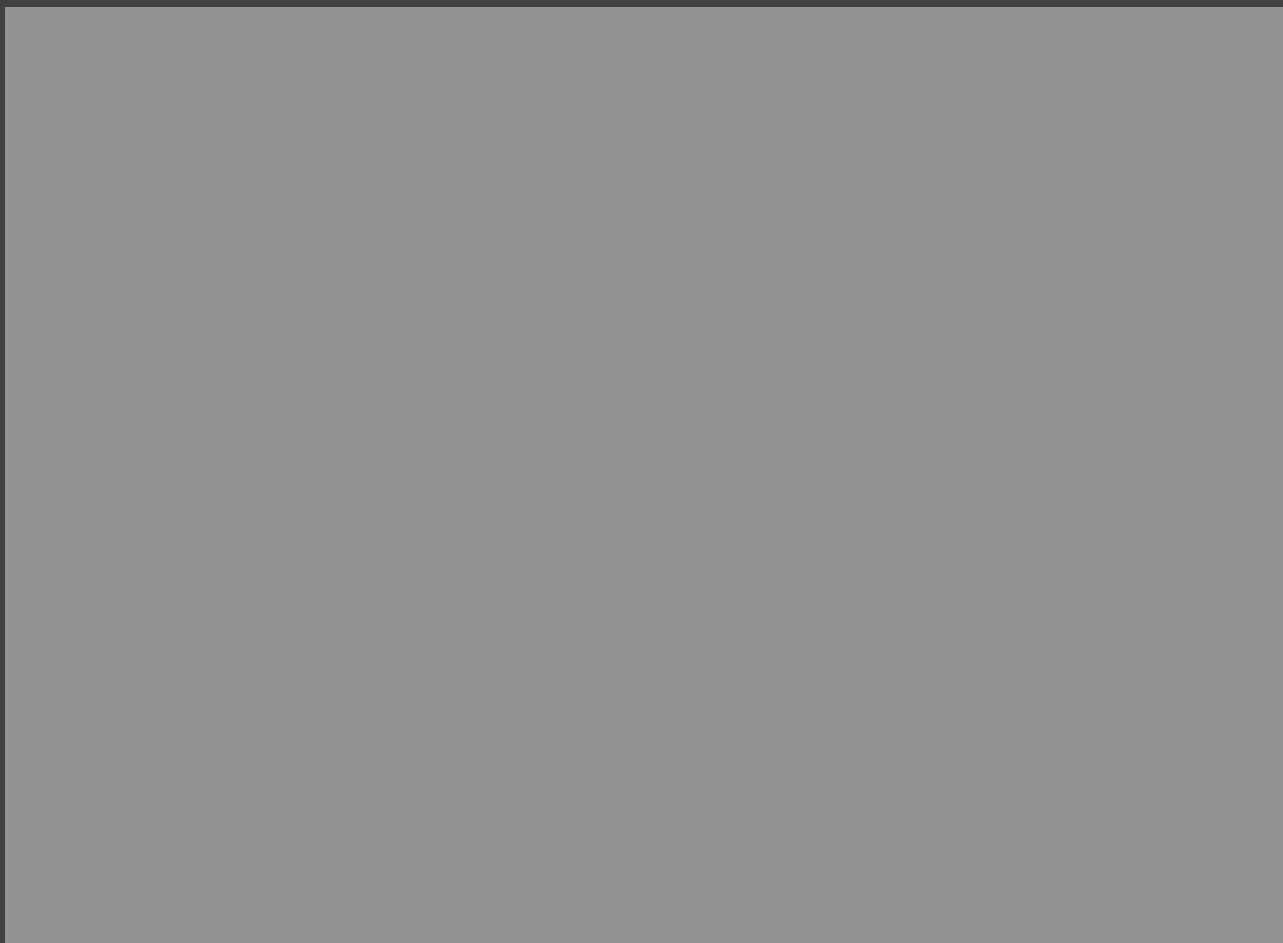

Change Blindness



Change Blindness



Change Blindness



[Example from Palmer 99, originally due to Rock]

Demonstrations

<http://www.psych.ubc.ca/~rensink/flicker/download/>

<http://www.youtube.com/watch?v=Ahg6qcgoy4>

Summary

Choosing effective visual encodings requires knowledge of visual perception.

Visual features/attributes

Individual attributes often pre-attentive

Multiple attributes may be separable or integral

Gestalt principles provide high-level guidelines

We don't always see everything that is there!