

2) a)

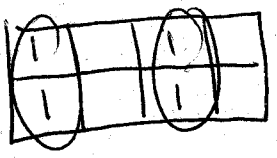

$$= X'Y' + XY$$

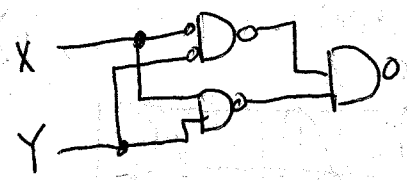

b)

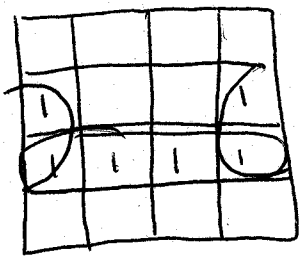

$$= X'Z + YZ$$

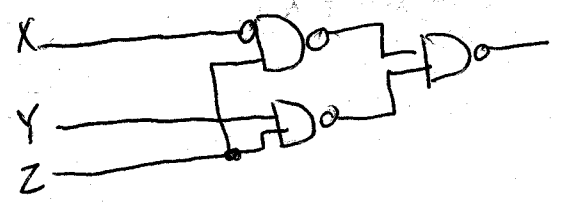

f)

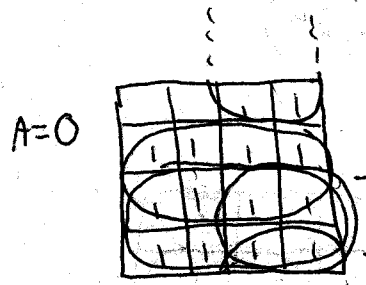

$$= A'D + A'E + BE' + BD + AB'D'$$

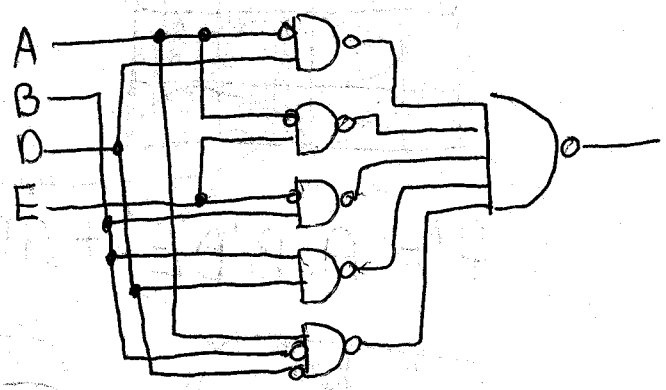
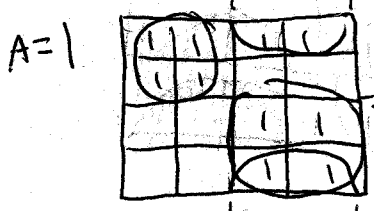

c)

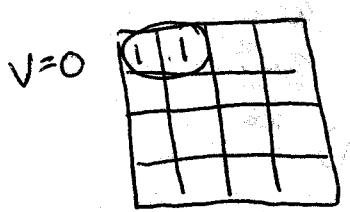

$$= VW'Y + VWY'Z + V'W'Y'Z'$$

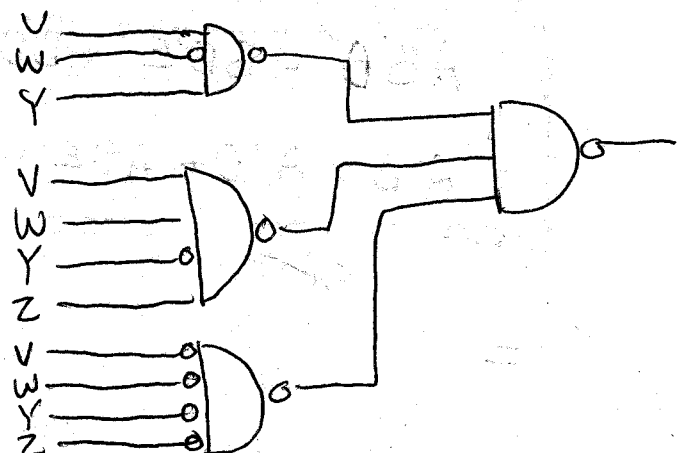
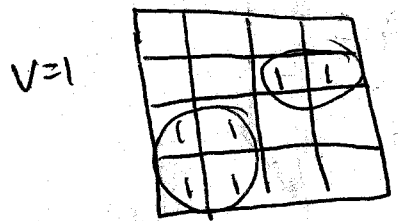

2 d)

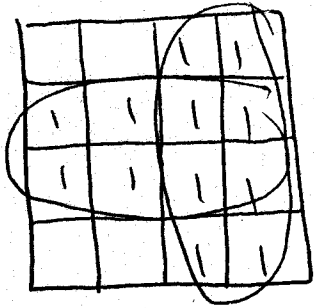

$$= A + D$$



E)

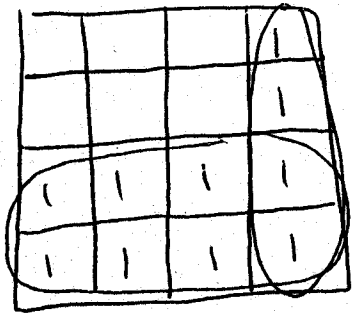

$$AB' + C$$

